

Circulator / High-efficiency Drinking Water Pump

CalioTherm S Pro

Also applies to CalioTherm S

Type Series Booklet



Legal information/Copyright

Type Series Booklet CalioTherm S Pro

All rights reserved. The contents provided herein must neither be distributed, copied, reproduced, edited or processed for any other purpose, nor otherwise transmitted, published or made available to a third party without the manufacturer's express written consent.

Subject to technical modification without prior notice.

© KSB SE & Co. KGaA, Frankenthal 2022-12-16

Contents

Building Services: Heating	4
Drinking Water Circulators, Fixed Speed Version	4
CalioTherm S Pro	4
Main applications.....	4
Fluids handled	4
Operating data.....	4
Design details	4
Designation	5
Materials.....	5
Product benefits.....	5
Product information	5
Selection information	6
Technical data	8
Selection chart.....	8
Characteristic curves.....	9
Dimensions	10
Installation information.....	10
Scope of supply	10
Accessories.....	11

Building Services: Heating

Drinking Water Circulators, Fixed Speed Version

CalioTherm S Pro

Also applies to CalioTherm S



Main applications

- Drinking water circulation systems to DVGW-W551

Fluids handled

- Heating water to VDI 2035
- Higher-viscosity fluids (water/glycol mixture up to a mixing ratio of 1:1)
- Drinking water and water for the food and beverage industry, as per German TrinkwV 2001 drinking water regulations

Operating data

Table 1: Operating properties

Characteristic		Value
Flow rate	Q [m³/h]	≤ 3,5
	Q [l/s]	≤ 1,0
Head	H [m]	≤ 6
Fluid temperature, heating water	T [°C]	≥ +2
		≤ +75
Fluid temperature, drinking water ¹⁾	T [°C]	≥ +2
		≤ +65
Hardness of drinking water as fluid handled	[°dH]	≤ 14
Ambient temperature	T [°C]	≥ 0
		≤ +40
Operating pressure	p [bar]	≤ 10
Average sound pressure level	[dB (A)]	≤ 30
Screw-ended connection	G	1 1/2

¹⁾ To prevent lime sedimentation using fluid temperatures no higher than 65 °C is recommended. Higher fluid temperatures are permissible for short periods (e.g. for thermal disinfection cycles).

Design details

Design

- Maintenance-free high-efficiency wet rotor pump (glandless)

Drive

- High-efficiency permanent magnet synchronous motor, brushless, self-cooling, with continuously variable differential pressure control
- 1~230 V AC +/- 10%
- Frequency 50 Hz/60 Hz
- Enclosure IPX4D
- Thermal class F
- Temperature class TF 95
- Interference emissions EN 55014-1, EN 61000-3-2, EN 61000-3-3
- Interference immunity EN 55014-2

Bearings

- Ceramic bearings

Connections

- Screw-ended

Operating modes

- Automatic mode with constant-pressure control or proportional-pressure control
- Open-loop control via setpoint setting

Automatic functions

- Continuously variable speed adjustment depending on the mode of operation
- Soft start (limitation of starting current)
- Full motor protection with integrated trip electronics
- Setback operation
- Dynamic Control in Proportional-pressure Control operating mode dp-v

Manual functions

- Setting the operating mode
- Setting the discharge head setpoint
- Setting the speed level
- Vent function
- Unlocking the rotor

Signalling functions and display functions

- Alternating display of flow rate, head and electrical input power
- Error codes indicated on the display

Designation

Example: CalioTherm S Pro 25-40

Table 2: Designation key

Code	Description	
CalioTherm S Pro	Type series	
25	Connection	
	25	G 1 1/2
40	Head H [m]	
	40	Head × 10 Example: 4 m × 10 = 40

Example: CalioTherm S 25-40

Table 3: Designation key

Code	Description	
CalioTherm S	Type series	
25	Connection	
	25	G 1 1/2
40	Head H [m]	
	40	Head × 10 Example: 4 m × 10 = 40

Materials

Table 4: Overview of available materials

Part No.	Description	Material
102	Volute casing	Stainless steel 1.4401
210	Shaft	Ceramics
230	Impeller	Polyether sulphone (PES)
310	Bearing	Ceramics
360	Bearing plate	Stainless steel 1.4301
689	Thermal insulation shell	Polypropylene
817	Can	Stainless steel 1.4301

Casing parts which are in contact with the atmosphere and with the fluid handled are free from paint-wetting impairment materials.

All wetted components are DVGW-approved for use in drinking water circulation systems.

Product benefits

- High-efficiency technology combined with speed control and efficient operation by means of **Dynamic Control** offer maximum savings.
- Easy-to-use combination of controls, integrated display and symbols to show the operating status
- High availability due to manual and integrated protective functions
- Compact dimensions and plug-type connector make the pumps easy to install.

Product information

Product information as per Regulation No. 1907/2006 (REACH)

For information as per European chemicals regulation (EC) No. 1907/2006 (REACH) see <https://www.ksb.com/en-global/company/corporate-responsibility/reach>.

Selection information

Minimum inlet pressure

The minimum inlet pressure p_{min} at the pump suction nozzle serves to avoid cavitation noises at the indicated fluid temperature T_{max} .

The indicated values are applicable up to 300 m above sea level. For installation at altitudes > 300 m, an allowance of 0.01 bar / 100 m must be added.

Table 5: Minimum inlet pressure p_{min} specified for the fluid temperature T_{max} .

Fluid temperature [°C]	Minimum inlet pressure [bar]
5 to 75	0,05

Dynamic Control description

The dynamic control (2) system detects when the selected control curve (3) is higher than the minimum characteristic curve²⁾ (4). The control system shifts the control curve downward, and power input is reduced automatically. To ensure sufficient supply the pump set switches to a higher control curve when the minimum characteristic curve is reached. The energy input is reduced (1) without any negative impact on the supply of the building.

The pump set is operated in an optimised way, even if the system characteristic curve is unknown; the noise at the thermostatic valves is reduced.

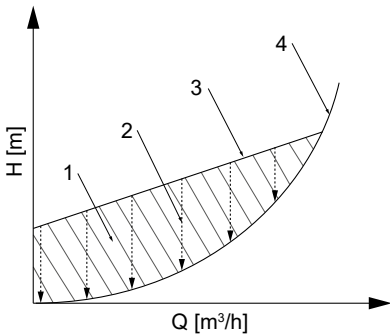

Fig. 1: Principle of dynamic control

1	Excess energy input	3	Control curve
2	Dynamic control	4	Minimum characteristic curve

² Characteristic curve at fully open thermostatic valves

Description of the characteristic curve

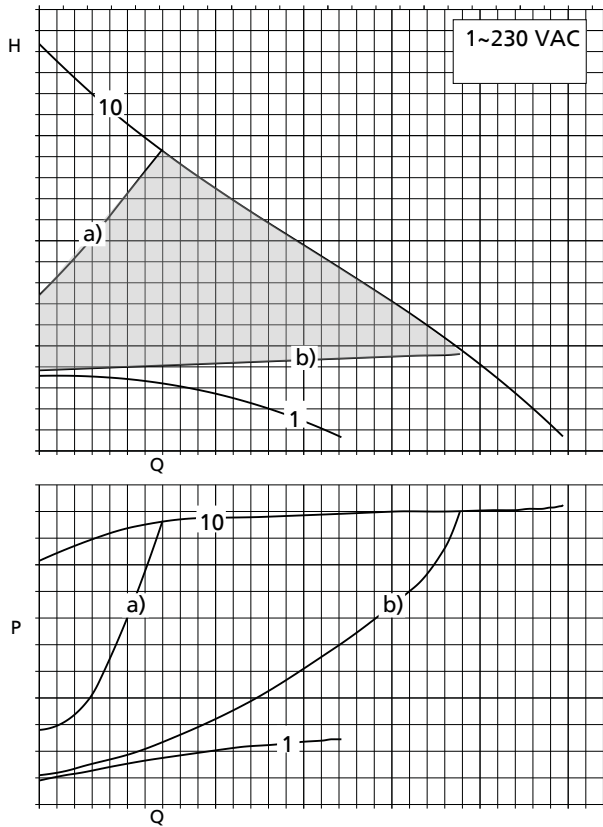

Fig. 2: Selection example

1	Minimum fixed speed operation
10	Maximum fixed speed operation
	Control range
a)	Control curve, maximum head
b)	Control curve, minimum head

The characteristic curve can be adjusted between a) and b) in increments of 0.1 m. This adjustment can be made with the control buttons.

Technical data

Technical data

Table 6: Technical data

Size	Connection		PN [bar]	P ₁ [W]	Motor protection ³⁾	Signalling contacts	I _N	Mat. No.	[kg]
	Piping	Pump					1~230 V AC, 50/60 Hz		
							[A]		
25-40	R 1	G 1 1/2	10	6 - 30	X	-	0,06 - 0,26	29134995	2,9
25-60	R 1	G 1 1/2	10	6 - 50	X	-	0,06 - 0,43	29134996	2,9

Selection chart

CalioTherm S Pro

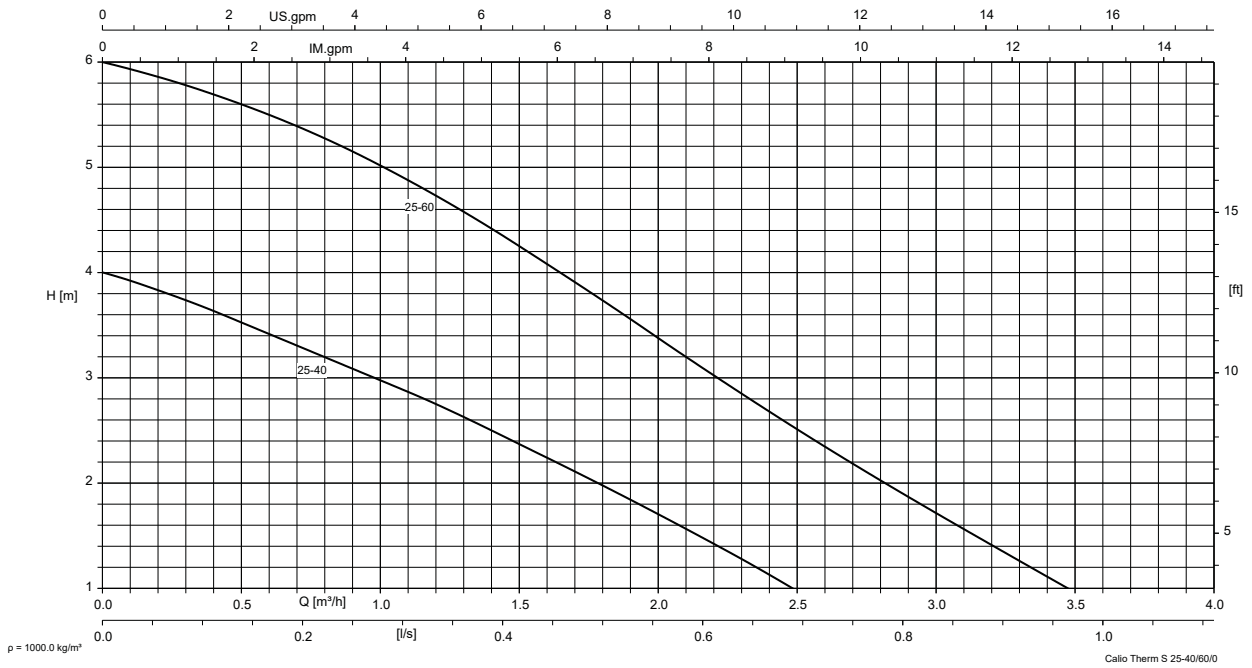

³ Integrated motor protection in the terminal box

Characteristic curves

CalioTherm S Pro 25-40 Δp_v , Δp_c

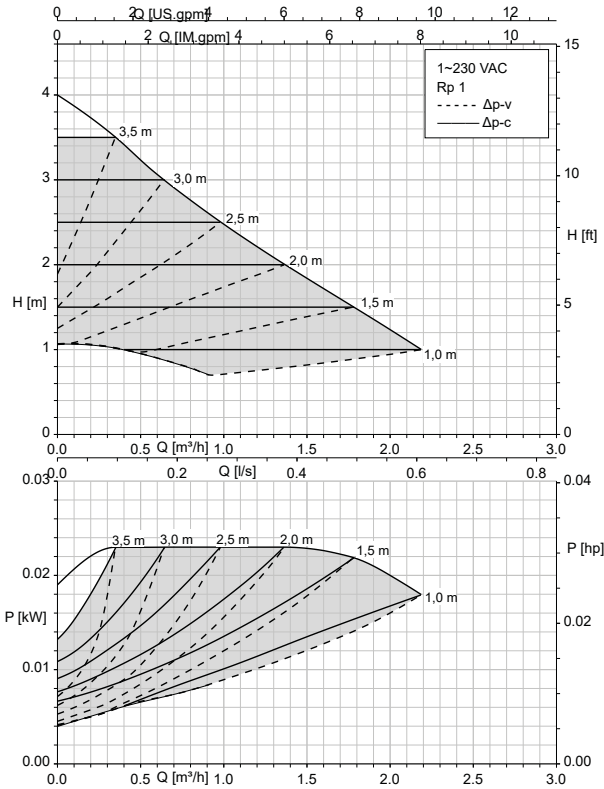

CalioTherm S Pro 25-40 fixed speed operation

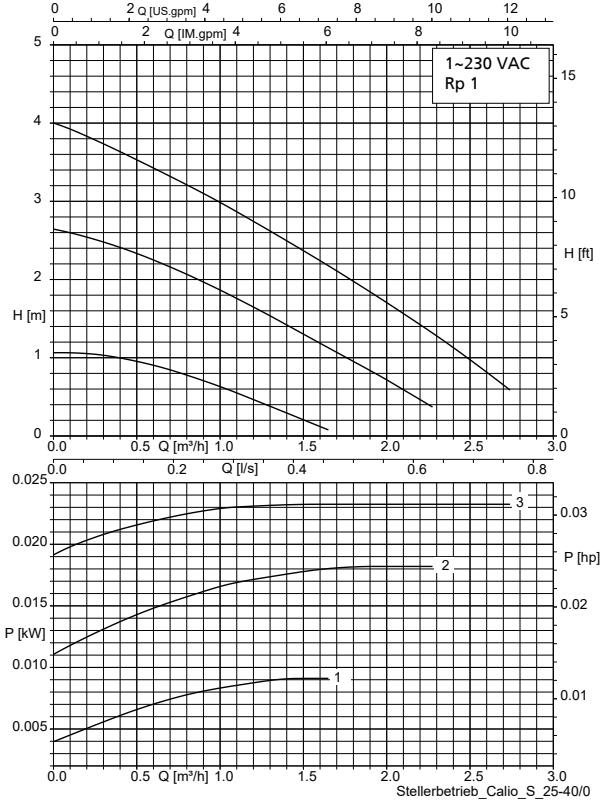
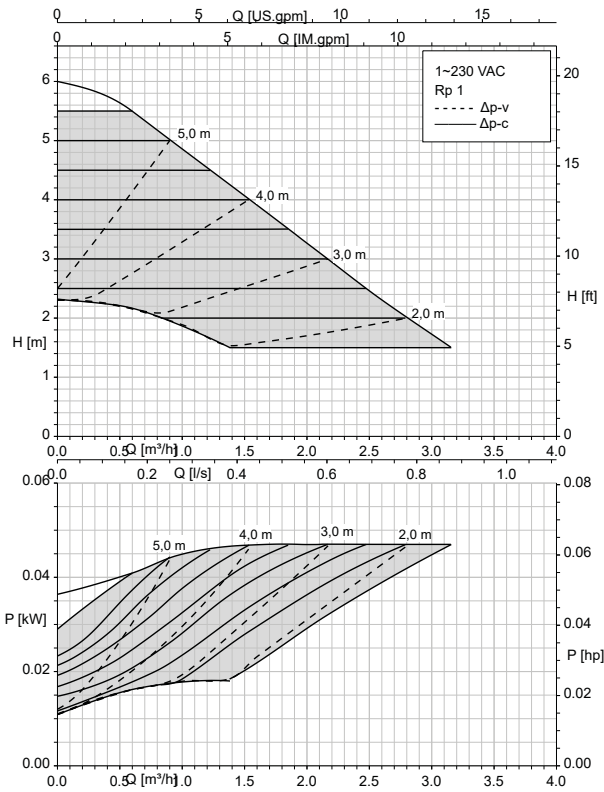

Fig. 3: 1, 2, 3 = speed level 1, 2, 3

CalioTherm S Pro 25-60 Δp_v , Δp_c



CalioTherm S Pro 25-60 fixed speed operation

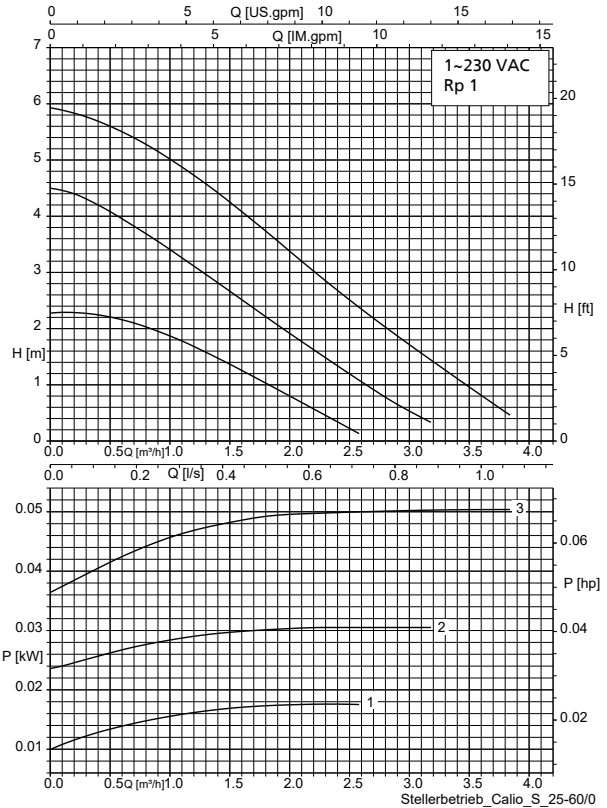

Fig. 4: 1, 2, 3 = speed level 1, 2, 3

1157.53/09-EN

Dimensions

CalioTherm S Pro

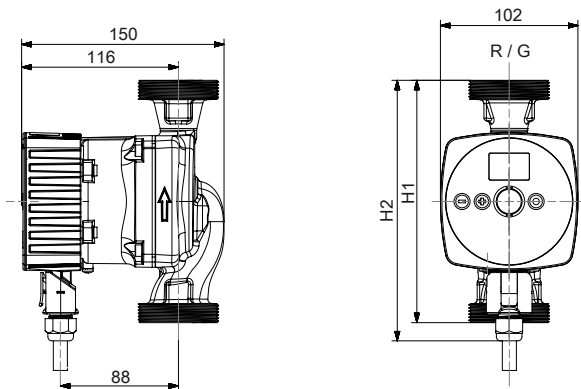

Fig. 5: Pump set dimensions [mm]

Table 7: Dimensions

Size	Connection		H1	H2
	R	G	[mm]	[mm]
25-40	1	1 1/2	180	200
25-60	1	1 1/2	180	200

Installation information

Permissible installation positions

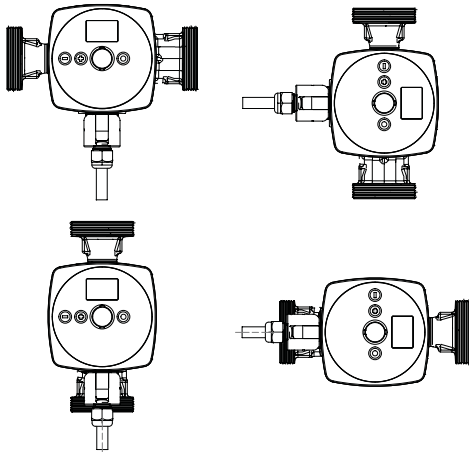

Fig. 6: Permissible installation positions

Scope of supply

Depending on the model, the following items are included in the scope of supply:

- Pump set
- Sealing elements
- Electrical plug-type connector with straight and angled plug housing
- Two-piece thermal insulation shell (only for overall length ≥ 180 mm)
- Installation/operating manual

Accessories

Pipe unions

Table 8: Pipe unions

	Description	Mat. No.	[kg]
	2 pipe unions with G 1 1/2 union nut and insert with Rp 1 internal thread, brass For pumps with G 1 1/2 external thread / R 1 pipe connection	19075564	0,2

Electrical accessories

Table 9: Electrical accessories

	Description	Mat. No.	[kg]
	Straight plug-type connector and angled connector for Calio S Pro / CalioTherm S Pro	01908056	0,1



KSB SE & Co. KGaA
Johann-Klein-Straße 9 • 67227 Frankenthal (Germany)
Tel. +49 6233 86-0
www.ksb.com