

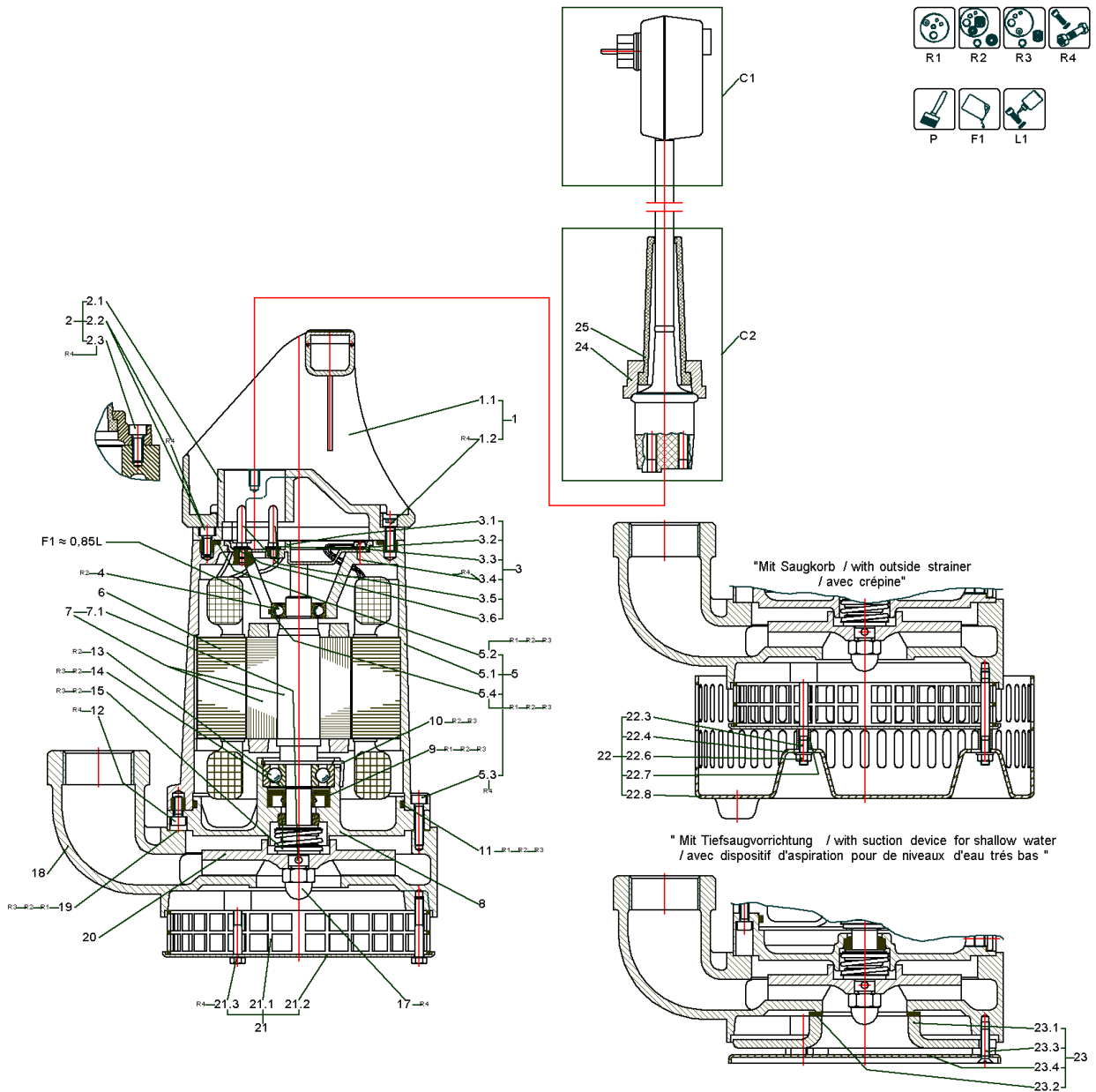

Article no.	Description
6000077	CONTRACTOR'S PUMP KE7 UNIT
6000078	CONTRACTOR'S PUMP KE7GG UNIT
6000079	CONTRACTOR'S PUMP KE8 UNIT
6000080	CONTRACTOR'S PUMP KE8GG UNIT
6000081	CONTRACTOR'S PUMP KE9 UNIT
6000082	CONTRACTOR'S PUMP KE9GG UNIT
6000104	CONTRACTOR'S PUMP KS5 UNIT
6000105	CONTRACTOR'S PUMP KS6 UNIT
6000112	CONTRACTOR'S PUMP KS8 UNIT
6000113	CONTRACTOR'S PUMP KS8GG UNIT
6000114	CONTRACTOR'S PUMP KS9 UNIT
6000115	CONTRACTOR'S PUMP KS9GG UNIT
6042087	CONTRACTOR'S PUMP KS12 D GG
6042089	CONTRACTOR'S PUMP KS12 DS GG
6042086	CONTRACTOR'S PUMP KS12 E GG
6042088	CONTRACTOR'S PUMP KS12 ES GG
6000086	CONTRACTOR'S PUMP KS14 UNIT
6000087	CONTRACTOR'S PUMP KS 14GG UNIT
6000088	CONTRACTOR'S PUMP KS15 UNIT
6000089	CONTRACTOR'S PUMP KS15GG UNIT
6000090	CONTRACTOR'S PUMP KS16 UNIT
6042090	CONTRACTOR'S PUMP KS20 D GG
6042091	CONTRACTOR'S PUMP KS20 DS GG
6000096	CONTRACTOR'S PUMP KS24 UNIT
6000098	CONTRACTOR'S PUMP KS37H UNIT
6000099	CONTRACTOR'S PUMP KS37M UNIT
6000100	CONTRACTOR'S PUMP KS37N UNIT
6000101	CONTRACTOR'S PUMP KS37ZH UNIT
6000102	CONTRACTOR'S PUMP KS37ZM UNIT
6000103	CONTRACTOR'S PUMP KS37ZN UNIT
6000106	CONTRACTOR'S PUMP KS70H UNIT
6000107	CONTRACTOR'S PUMP KS70M UNIT
6000108	CONTRACTOR'S PUMP KS70N UNIT
6000109	CONTRACTOR'S PUMP KS70ZH UNIT

EMU KE/KS

Article no.	Description
6000110	CONTRACTOR'S PUMP KS70ZM UNIT
6000111	CONTRACTOR'S PUMP KS70ZN UNIT
6000091	CONTRACTOR'S PUMP KS220H UNIT
6000092	CONTRACTOR'S PUMP KS220MH UNIT
6000093	CONTRACTOR'S PUMP KS220MN UNIT
6000094	CONTRACTOR'S PUMP KS220N UNIT



CONTRACTOR'S PUMP KE7 UNIT (6000077)

Item	Article no.	Description	Quantity
R1	6016271	Rep.Kit 1 KE7,8,9 Vit	1
R2	6016283	Rep.Kit 2 KE7,8,9 Vit	1
R3	6016296	Rep.Kit 3 KE7,8,9 Vit	1
R4	6016132	Screws KS8,9,12,14,15 KE7;8;9, F12 KIT	1
P	6042254	PAINT SPRAY Pantone334	1
P	6042255	colour 2K-paint IV80 pantone334C 250ml	1
P	6023614	Ceram C0 black 100 ml KIT	1
P	6020579	Ceram C0 black 250 ml KIT	1
P	6023485	Ceram C0 Black 500ml Kit	1
P	6019157	Ceram C0 black 1000 ml KIT	1
F1	6025460	medical white oil 1L KIT	1
L1	6080531	Loctite 243 5g flask VP:	1
L1	2096167	Loctite 243 50ml VP.	1

C1		PLUG	1
C2		cable for motor F12 / F13	1

1	6019566	handle 51.15480/1 plastics KIT	1
1.2		> screw M5x16 ISO4762 A2-70	1
1.1		> handle 51.15480/1 Akulon	1
2	6022949	motor cover D.95,8 51.17219 GG KIT	1
2.1		> motor cover D.95,8 51.17219 GG	1
2.2		> SCREW M5X12 ISO4762 A2-70	3
2.3		> screw M6x16 DIN912 A4 (10pc)	1
3	6001273	terminal board 54.3453 Makrolon KIT	1
3.1		> terminal board plastics Polycarbonat	1
3.5		> contact pin Ms	4
3.2		> lock washer 4 DIN7980 A4	1
3.3		> washer A4,3 DIN125 Ms	5
3.4		> screw M4x8 DIN84 Ms	1
3.6		> washer 4,3 DIN7349 Ms	1
4	6086141	ball bearing 6002 VP.	1
5	6021772	motor casing 52.3441 Al KIT	1
5.1		> motor casing 52.3441 Al	1

CONTRACTOR'S PUMP KE7 UNIT (6000077)

Item	Article no.	Description	Quantity
5.2		> o-ring ID.92,0x3,0 Viton	1
5.3		> screw M5x25 DIN912 A2-70	3
Note: für / for / pour KE			
5.3		> screw M5x45 ISO4762 A2-70	3
Note: für / for / pour KS			
5.4		> o-ring ID.32x1,78 Viton	1
Stator / stator / stator 50 Hz			
6	6023535	stator F12-2/6 230E 50Hz Ser11	1
6	6023532	stator F12-2/6 400 50Hz VN 01	1
6	6023533	stator F12-2/6 415 50Hz VN 01	1
6	6023534	stator F12-2/6 500 50Hz VN 01	1
Note: Original Laufräder nicht mehr lieferbar / original impellers no longer available / Les roues originales ne sont plus disponibles			
alternativ / alternative / alternative			
6	6023531	stator F12-2/6 230 50Hz	1
Stator / stator / stator 60 Hz			
6	6023536	stator F12-2/6 230E 60Hz Ser11	1
6	6023537	stator F12-2/6 230/400 60Hz	1
7	6010022	rotor D.61,4x169 2/6 1.4021	1
7.1	6002743	slotted pin 4x6 DIN1473 1.4305	1
8	6017894	bearing end plate 53.3450/1 GG	1
9	6007489	shaft seal ring A15/37x10 DIN3760 NBR+A2	1
alternativ / alternative / alternative			
9	6019482	shaft seal ring A15x37x10 DIN3760 NBR LA	1
10	6004669	circlips 43,6x1,8 54.3438 FSt	1
11		o-ring ID.115,0x3,0 Viton -	1
12		SCREW M5X12 ISO4762 A2-70	3
13	6008975	ball bearing 6302	1
14	6002007	circlips 15x1 DIN471 FSt	1
15	6075396	mech shaft seal MG1/15-G64 BXP GG VP.	1
alternativ / alternative / alternative			
15	6003878	mechanical shaft seal MG1/15-G4 Q1Q1VGG	1
17	6002104	domet nut M10 DIN1587 A2	1
18	6012849	pump housing A G11/4 52.10520/1 Al	1
alternativ / alternative / alternative			

CONTRACTOR'S PUMP KE7 UNIT (6000077)

Item	Article no.	Description	Quantity
18	6021683	pump housing A G11/4 52.19207 Al/C0	1
18	6012850	pump housing A G11/4 52.10520/2 GG	1
18	6012848	pump hou. AG1 1/4 GG/C0 52.19207	1
18	6024442	pump housing A G11/4 52.19189 Abrasit	1
18	6022781	pump housing A G11/4 52.19189 Abrasit/C0	1
18	6012903	pump housing AG1 1/4 1.4581 52.16782VN00	1
19	6048831	flat gasket D.125/155 ARAMID/NBR (10pc)	1
20		information	1
Note: Original Laufräder nicht mehr lieferbar/ original impellers no longer available			
alternativ / alternative / alternative			
Laufrad / Impeller / Roue 50Hz			
20	6014013	impeller-W D.114 54.2392/1 GG	1
20	6014005	impeller-W D.114 54.2392/1 GG/C0	1
Laufrad / Impeller / Roue 60Hz			
20	6014009	impeller-W D.97 54.2114/1 GG	1
20	6021758	Impeller-W D.97 54.2114/1 GG/C0	1
21	6001147	strainer 54.10534/1 1.4301 KIT	1
21.1		> strainer 26x155x2 1.4301	1
21.2		> base plate D.160x3 1,5 1.4301	1
21.3		> screw M5x35 ISO4014 A2-70	3
22	6032617	add on strainer KS 8/9 KIT	1
23	6021392	suction plate 53.17572 GG KIT	1
23.1		> suction plate 53.17572 GG	1
23.2	6004149	> flat gasket D.50/65x2 NBR	1
23.3	6002405	> screw M5x20 DIN963 A4	3
23.4		> base plate D.160x3 1,5 1.4301	1
24	6004828	cable gland Akulon	1
25	6003824	cable peotection NBR 87x30 mm	1

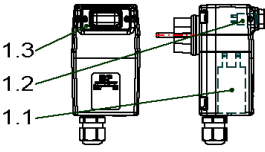
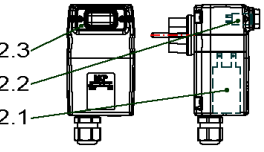
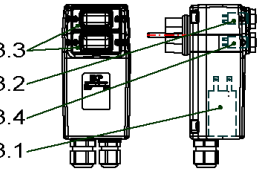
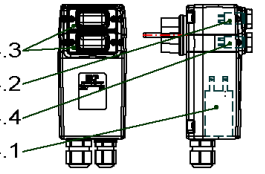
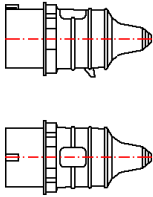
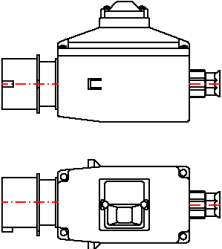
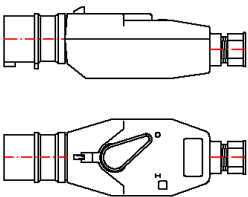
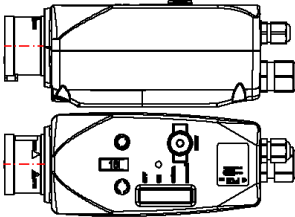
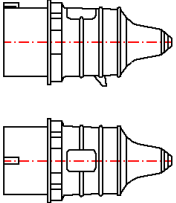
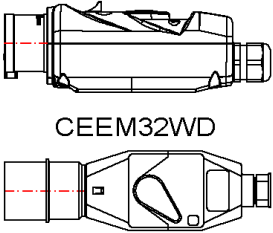
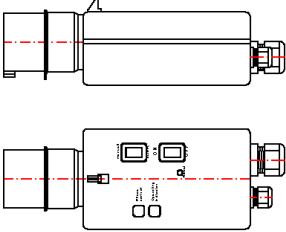
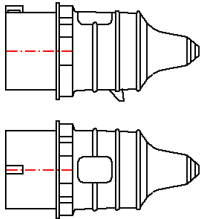
<p>1 MCP 6A-M-H-20μF ~ 230V</p>  <p>$I_N(230V / 50Hz) < 6A = 20\mu F$</p>	<p>2 MCP 10A-M-H-30μF ~ 230V</p>  <p>$I_N(230V / 50Hz) 6-10A = 30\mu F$</p>	<p>3 MCP 6A-M-HA-20μF ~ 230V</p>  <p>$I_N(230V / 50Hz) < 6A = 20\mu F$</p>	<p>4 MCP 10A-M-HA-30μF ~ 230V</p>  <p>$I_N(230V / 50Hz) 6-10A = 30\mu F$</p>
<p>5 CEE16A</p> 	<p>6 CEEM16W</p> 	<p>7 CEEM16WD</p> 	<p>8 MCP T4-HA-ROT-WSK CEE16-5PS</p> 
<p>9 CEE32A</p> 	<p>10 MCP 10-16A-T4-H-ROT CEE32-5PS</p>  <p>CEEM32WD</p>	<p>11 CEEM32WDSHA</p> 	<p>12 CEE63A</p> 

PLUG

Item	Article no.	Description	Quantity
		IN (230V / 50Hz) <6A - 20µF	
1	6072332	MCP 6A-M-H-20µF-CEE7/7 VP.	1
1.1	6071702	capacitor 400V 20µF MCP VP.	1
1.2	6071704	protection switch 6A MCP VP.	1
1.3	6071707	protecting cap MCP VP.	1
		IN (230V / 50Hz) 6-10A - 30µF	
2	6072330	MCP 10A-M-H-30µF-CEE7/7 VP.	1
2.1	6071703	capacitor 400V 30µF MCP VP.	1
2.2	6071705	protection switch 10A MCP VP.	1
2.3	6071707	protecting cap MCP VP.	1
		IN (230V / 50Hz) <6A - 20µF	
3	6072331	MCP 6A-M-HA-20µF-CEE7/7 VP.	1
3.1	6071702	capacitor 400V 20µF MCP VP.	1
3.2	6071704	protection switch 6A MCP VP.	1
3.3	6071707	protecting cap MCP VP.	2
3.4	6071706	switch on/out MCP VP.	1
		IN (230V / 50Hz) 6-10A - 30µF	
4	6072329	MCP 10A-M-HA-30µF-CEE7/7 VP	1
4.1	6071703	capacitor 400V 30µF MCP VP.	1
4.2	6071705	protection switch 10A MCP VP.	1
4.3	6071707	protecting cap MCP VP.	2
4.4	6071706	switch on/out MCP VP.	1
5	6003000	plug CEE16A/400V 60Hz/5P-11h	1
5	6003248	plug CEE16A/400V/4P-6H	1
5	6003009	plug CEE16A/400V/5P-6H	1
5	6039156	plug CEE16A/400V/5P-6H Phase inverter	1
5	6035231	plug CEE16A/400V/7P-6H	1
5	6003011	plug CEE16A/500V/5P-7H	1
6	6030883	plug MS400V5P CEE16A W 1,0-1,6A	1
6	6030884	plug MS400V5P CEE16A W 1,6-2,5A	1
6	6030888	plug MS400V5P CEE16A W 10,0-16,0A	1
6	6030885	plug MS400V5P CEE16A W 2,5-4,0A	1
6	6030886	plug MS400V5P CEE16A W 4,0-6,3A	1
6	6030887	plug MS400V5P CEE16A W 6,3-10,0A	1

PLUG

Item	Article no.	Description	Quantity
7	6032446	plug MS400V4P CEE16A WD 1,6-2,5A	1
7	6032447	plug MS400V4P CEE16A WD 12,5-16,0A	1
7	6032295	plug MS400V4P CEE16A WD 2,5-4,0A	1
7	6032289	plug MS400V4P CEE16A WD 4,0-6,3A	1
7	6032292	plug MS400V4P CEE16A WD 6,3-9,0A	1
7	6042190	plug MS400V5P CEE16A WDII 1,6-2,5A	1
7	6042194	plug MS400V5P CEE16A WDII 10,0-16,0A	1
7	6042191	plug MS400V5P CEE16A WDII 2,5-4,0A	1
7	6042192	plug MS400V5P CEE16A WDII 4,0-6,3A	1
7	6042193	plug MS400V5P CEE16A WDII 6,3-10,0A	1
7	6035911	plug MS400V5P CEE16A WD 9,0-12,5A	1
7	6003337	plug MS500V5P CEE16A WD 1,6-2,5A	1
7	6003336	plug MS500V5P CEE16A WD 2,5-4,0A	1
7	6003335	plug MS500V5P CEE16A WD 4,0-6,3A	1
7	6003334	plug MS500V5P CEE16A WD 6,3-9,0A	1
8	6072520	MCP 1,0-1,6A-T4-HA-ROT-WSK-CEE16-5PS VP.	1
8	6072521	MCP 1,6-2,4A-T4-HA-ROT-WSK-CEE16-5PS VP.	1
8	6072522	MCP 2,4-4,0A-T4-HA-ROT-WSK-CEE16-5PS VP.	1
8	6072523	MCP 4,0-6,0A-T4-HA-ROT-WSK-CEE16-5PS VP.	1
8	6072524	MCP 6,0-10A-T4-HA-ROT-WSK-CEE16-5PS VP.	1
8	6072525	MCP 9,0-12A-T4-HA-ROT-WSK-CEE16-5PS VP.	1
8	6072526	MCP 12-16A-T4-HA-ROT-WSK-CEE16-5PS VP.	1
9	6003267	plug CEE32A/400V/4P-6H	1
9	6039155	plug CEE32A/400V/5P-6H Phase inverter	1
9	6035895	plug CEE32A/500V/4P-7H AM-Top	1
9	6003010	plug CEE32A/500V/5P-7H	1
10	6072370	MCP 400V 1,6-2,5A-T4-H-ROT-CEE32-5PS VP.	1
10	6072369	MCP 400V 2,5-4,0A-T4-H-ROT-CEE32-5PS VP.	1
10	6072371	MCP 400V 4,0-6,3A-T4-H-ROT-CEE32-5PS VP.	1
10	6072398	MCP 400V 6,3-10A-T4-H-ROT-CEE32-5PS VP.	1
10	6072519	MCP 400V 10-16A-T4-H-ROT-CEE32-5PS VP.	1
10	6072399	MCP 400V 16-20A-T4-H-ROT-CEE32-5PS VP.	1
10	6072518	MCP 400V 20-25A-T4-H-ROT-CEE32-5PS VP.	1
10	6037649	plug.MS500V4P CEE32A WD 2,5-4,0A	1

PLUG

Item	Article no.	Description	Quantity
10	6041268	plug MS500V4P CEE32A WD 4,0-6,3A	1
10	6035244	plug MS500V5P CEE32A WD 1,6-2,5A	1
10	6034700	plug MS500V5P CEE32A WD 2,5-4,0A	1
10	6041556	plug MS500V5P CEE32A WD 4,0-6,3A	1
10	6002701	plug MS500V5P CEE32A WD 9,0-12,5A	1
10	6002700	plug MS500V5P CEE32A WD 12,5-16,0A	1
11	6003241	plug MS400V5P CEE32A WDSHA 10,0-14,0A	1
11	6003266	plug MS400V5P CEE32A WDSHA 3,7-5,5A	1
11	6003265	plug MS400V5P CEE32A WDSHA 5,5-8,0A	1
11	6003264	plug MS400V5P CEE32A WDSHA 8,0-11,5A	1
12	6003012	plug CEE63A/400V/5P-6H/IP67	1

cable for motor F12 / F13

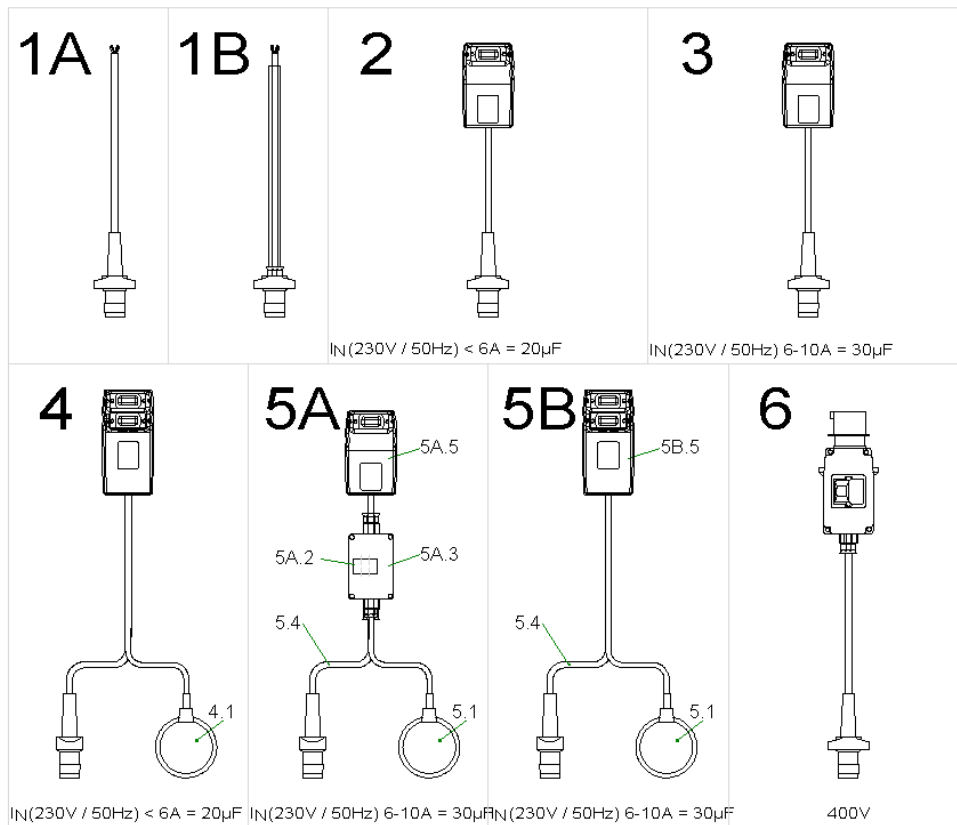

cable for motor F12 / F13

Item	Article no.	Description	Quantity
1A	6072559	cable 5m H07 4G1,5/coupling VP.	1
1A	6072560	cable 10m H07 4G1,5/coupling VP.	1
1A	6072561	cable 20m H07 4G1,5/coupling VP.	1
1A	6072562	cable 30m H07 4G1,5/coupling VP.	1
1A	6072563	cable 40m H07 4G1,5/coupling VP.	1
1A	6087533	cable 40m H07 4G1,5/coupling VP.	1
1B	6072564	cable 10m H07 4G1,5/coupl./hose VP. IN (230V / 50Hz) <6A - 20μF	1
2	6072565	switch box MCP 6A H 5M VP.	1
2	6072566	switch box MCP 6A H 10M VP.	1
2	6072567	switch box MCP 6A H 20M VP. IN (230V / 50Hz) 6-10A - 30μF	1
3	6072568	switch box MCP 10A H 5M VP.	1
3	6072569	switch box MCP 10A H 10M VP.	1
3	6072570	switch box MCP 10A H 20M VP. IN (230V / 50Hz) <6A - 20μF	1
4	6072571	switch box MCP 6A HA 5M VP.	1
4	6072572	switch box MCP 6A HA 10M VP.	1
4.1	6072582	float switch S-PS 10A 250V 10m NO VP	1
4	6072576	switch box MCP 6A HA 20M VP.	1
4.1	6072583	float switch S-PS 10A 250V 20m NO VP IN (230V / 50Hz) 6-10A - 30μF	1
5A		on request	1
5B	6072577	switch box MCP 10A HA 10M	1
5.1	6072582	float switch S-PS 10A 250V 10m NO VP	1
5A.2	6003341	contactor 5,5 kW 230 V, 50 Hz	1
5A.3	6031509	blank casing KS12/15ES KIT	1
5.4	6072560	cable 10m H07 4G1,5/coupling VP.	1
5A.5	6072330	MCP 10A-M-H-30μF-CEE7/7 VP.	1
5B.5	6072329	MCP 10A-M-HA-30μF-CEE7/7 VP für / for / pour 400V	1
6	6023991	switch box CEEM16W 2,5A, 10m SVA	1
6	6001253	switch box CEEM16W 4A, 10m SVA	1
6	6023992	switch box CEEM16W 6,3A, 20m SVA	1

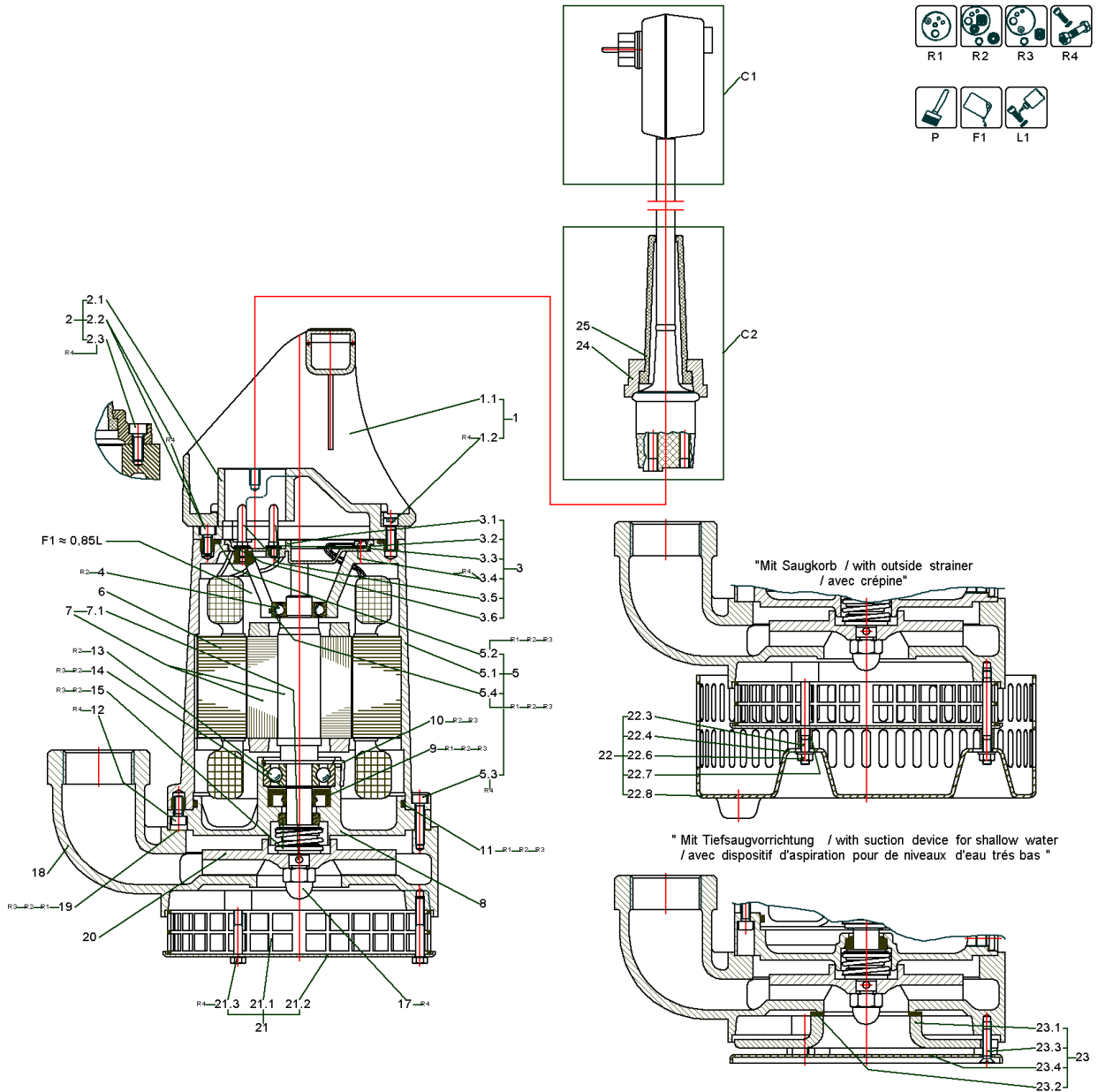

CONTRACTOR'S PUMP KE7GG UNIT (6000078)

Item	Article no.	Description	Quantity
R1	6016271	Rep.Kit 1 KE7,8,9 Vit	1
R2	6016283	Rep.Kit 2 KE7,8,9 Vit	1
R3	6016296	Rep.Kit 3 KE7,8,9 Vit	1
R4	6016132	Screws KS8,9,12,14,15 KE7;8;9, F12 KIT	1
P	6042254	PAINT SPRAY Pantone334	1
P	6042255	colour 2K-paint IV80 pantone334C 250ml	1
P	6023614	Ceram C0 black 100 ml KIT	1
P	6020579	Ceram C0 black 250 ml KIT	1
P	6023485	Ceram C0 Black 500ml Kit	1
P	6019157	Ceram C0 black 1000 ml KIT	1
F1	6025460	medical white oil 1L KIT	1
L1	6080531	Loctite 243 5g flask VP:	1
L1	2096167	Loctite 243 50ml VP.	1

C1		PLUG	1
C2		cable for motor F12 / F13	1

1	6019566	handle 51.15480/1 plastics KIT	1
1.2		> screw M5x16 ISO4762 A2-70	1
1.1		> handle 51.15480/1 Akulon	1
2	6022949	motor cover D.95,8 51.17219 GG KIT	1
2.1		> motor cover D.95,8 51.17219 GG	1
2.2		> SCREW M5X12 ISO4762 A2-70	3
2.3		> screw M6x16 DIN912 A4 (10pc)	1
3	6001273	terminal board 54.3453 Makrolon KIT	1
3.1		> terminal board plastics Polycarbonat	1
3.5		> contact pin Ms	4
3.2		> lock washer 4 DIN7980 A4	1
3.3		> washer A4,3 DIN125 Ms	5
3.4		> screw M4x8 DIN84 Ms	1
3.6		> washer 4,3 DIN7349 Ms	1
4	6086141	ball bearing 6002 VP.	1
5	6022378	motor casing 52.2924/1E GG KIT	1
5.1		> motor casing 52.2924/1 GG	1

CONTRACTOR'S PUMP KE7GG UNIT (6000078)

Item	Article no.	Description	Quantity
5.2		> o-ring ID.92,0x3,0 Viton	1
5.3		> screw M5x25 DIN912 A2-70	3
5.3		> screw M5x45 ISO4762 A2-70	3
Note: für / for / pour KS			
5.4		> o-ring ID.32x1,78 Viton	1
		Stator / stator / stator 50 Hz	
6	6023535	stator F12-2/6 230E 50Hz Ser11	1
6	6023532	stator F12-2/6 400 50Hz VN 01	1
Note: Original Laufräder nicht mehr lieferbar / original impellers no longer available / Les roues originales ne sont plus disponibles			
6	6023533	stator F12-2/6 415 50Hz VN 01	1
6	6023534	stator F12-2/6 500 50Hz VN 01	1
		alternativ / alternative / alternative	
6	6023531	stator F12-2/6 230 50Hz	1
		Stator / stator / stator 60 Hz	
6	6023536	stator F12-2/6 230E 60Hz Ser11	1
6	6023537	stator F12-2/6 230/400 60Hz	1
7	6010022	rotor D.61,4x169 2/6 1.4021	1
7.1	6002743	slotted pin 4x6 DIN1473 1.4305	1
8	6017894	bearing end plate 53.3450/1 GG	1
9	6007489	shaft seal ring A15/37x10 DIN3760 NBR+A2	1
		alternativ / alternative / alternative	
9	6019482	shaft seal ring A15x37x10 DIN3760 NBR LA	1
10	6004669	circlips 43,6x1,8 54.3438 FSt	1
11		o-ring ID.115,0x3,0 Viton -	1
12		SCREW M5X12 ISO4762 A2-70	3
13	6008975	ball bearing 6302	1
14	6002007	circlips 15x1 DIN471 FSt	1
15	6075396	mech shaft seal MG1/15-G64 BXPGG VP.	1
		alternativ / alternative / alternative	
15	6003878	mechanical shaft seal MG1/15-G4 Q1Q1VGG	1
17	6002104	domet nut M10 DIN1587 A2	1
18	6012850	pump housing A G11/4 52.10520/2 GG	1
		alternativ / alternative / alternative	
18	6012848	pump hou. AG1 1/4 GG/C0 52.19207	1

CONTRACTOR'S PUMP KE7GG UNIT (6000078)

Item	Article no.	Description	Quantity
18	6024442	pump housing A G11/4 52.19189 Abrasit	1
18	6022781	pump housing A G11/4 52.19189 Abrasit/C0	1
18	6012903	pump housing AG1 1/4 1.4581 52.16782VN00	1
19	6048831	flat gasket D.125/155 ARAMID/NBR (10pc)	1
20		information	1
Note: Original Laufräder nicht mehr lieferbar/ original impellers no longer available			
alternativ / alternative / alternative			
Laufrad / Impeller / Roue 50Hz			
20	6014013	impeller-W D.114 54.2392/1 GG	1
20	6014005	impeller-W D.114 54.2392/1 GG/C0	1
20	6010632	impeller-W D.114 54.17902 Abrasit	1
20	6022790	impeller-W D.114 54.17902 Abrasit/C0	1
20	6014011	impeller-W D.114 54.2392/1 1.4581	1
Laufrad / Impeller / Roue 60Hz			
20	6014009	impeller-W D.97 54.2114/1 GG	1
20	6021758	Impeller-W D.97 54.2114/1 GG/C0	1
20	6022788	impeller-W D.97 54.17902 Abrasit	1
20	6022789	impeller-W D.97 54.17902 Abrasit/C0	1
20	6021647	impeller-W D.97 54.2114/1 1.4581	1
21	6001147	strainer 54.10534/1 1.4301 KIT	1
21.1		> strainer 26x155x2 1.4301	1
21.2		> base plate D.160x3 1,5 1.4301	1
21.3		> screw M5x35 ISO4014 A2-70	3
22	6032617	add on strainer KS 8/9 KIT	1
23	6021392	suction plate 53.17572 GG KIT	1
23.1		> suction plate 53.17572 GG	1
23.2	6004149	> flat gasket D.50/65x2 NBR	1
23.3	6002405	> screw M5x20 DIN963 A4	3
23.4		> base plate D.160x3 1,5 1.4301	1
24	6004828	cable gland Akulon	1
25	6003824	cable peotection NBR 87x30 mm	1

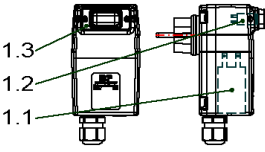
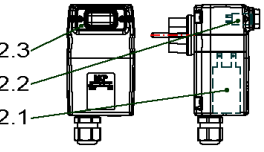
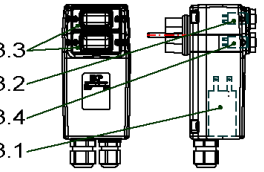
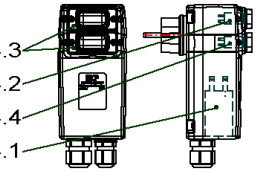
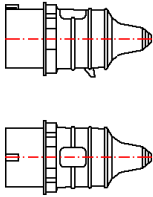
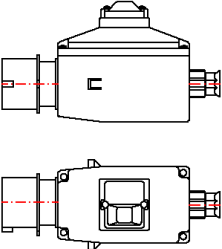
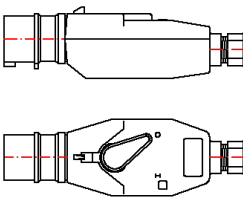
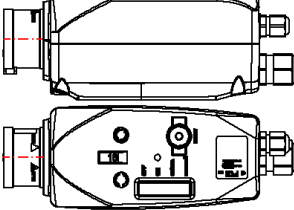
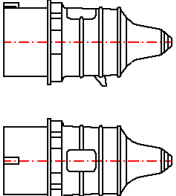
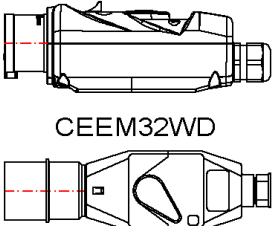
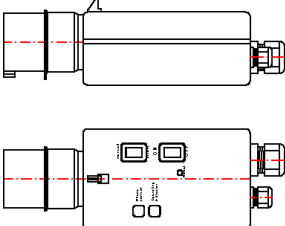
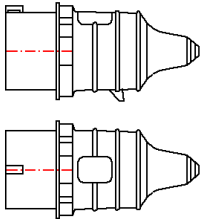
<p>1 MCP 6A-M-H-20μF ~ 230V</p>  <p>$I_N(230V / 50Hz) < 6A = 20\mu F$</p>	<p>2 MCP 10A-M-H-30μF ~ 230V</p>  <p>$I_N(230V / 50Hz) 6-10A = 30\mu F$</p>	<p>3 MCP 6A-M-HA-20μF ~ 230V</p>  <p>$I_N(230V / 50Hz) < 6A = 20\mu F$</p>	<p>4 MCP 10A-M-HA-30μF ~ 230V</p>  <p>$I_N(230V / 50Hz) 6-10A = 30\mu F$</p>
<p>5 CEE16A</p> 	<p>6 CEEM16W</p> 	<p>7 CEEM16WD</p> 	<p>8 MCP T4-HA-ROT-WSK CEE16-5PS</p> 
<p>9 CEE32A</p> 	<p>10 MCP 10-16A-T4-H-ROT CEE32-5PS</p>  <p>CEEM32WD</p>	<p>11 CEEM32WDSHA</p> 	<p>12 CEE63A</p> 

PLUG

Item	Article no.	Description	Quantity
		IN (230V / 50Hz) <6A - 20µF	
1	6072332	MCP 6A-M-H-20µF-CEE7/7 VP.	1
1.1	6071702	capacitor 400V 20µF MCP VP.	1
1.2	6071704	protection switch 6A MCP VP.	1
1.3	6071707	protecting cap MCP VP.	1
		IN (230V / 50Hz) 6-10A - 30µF	
2	6072330	MCP 10A-M-H-30µF-CEE7/7 VP.	1
2.1	6071703	capacitor 400V 30µF MCP VP.	1
2.2	6071705	protection switch 10A MCP VP.	1
2.3	6071707	protecting cap MCP VP.	1
		IN (230V / 50Hz) <6A - 20µF	
3	6072331	MCP 6A-M-HA-20µF-CEE7/7 VP.	1
3.1	6071702	capacitor 400V 20µF MCP VP.	1
3.2	6071704	protection switch 6A MCP VP.	1
3.3	6071707	protecting cap MCP VP.	2
3.4	6071706	switch on/out MCP VP.	1
		IN (230V / 50Hz) 6-10A - 30µF	
4	6072329	MCP 10A-M-HA-30µF-CEE7/7 VP	1
4.1	6071703	capacitor 400V 30µF MCP VP.	1
4.2	6071705	protection switch 10A MCP VP.	1
4.3	6071707	protecting cap MCP VP.	2
4.4	6071706	switch on/out MCP VP.	1
5	6003000	plug CEE16A/400V 60Hz/5P-11h	1
5	6003248	plug CEE16A/400V/4P-6H	1
5	6003009	plug CEE16A/400V/5P-6H	1
5	6039156	plug CEE16A/400V/5P-6H Phase inverter	1
5	6035231	plug CEE16A/400V/7P-6H	1
5	6003011	plug CEE16A/500V/5P-7H	1
6	6030883	plug MS400V5P CEE16A W 1,0-1,6A	1
6	6030884	plug MS400V5P CEE16A W 1,6-2,5A	1
6	6030888	plug MS400V5P CEE16A W 10,0-16,0A	1
6	6030885	plug MS400V5P CEE16A W 2,5-4,0A	1
6	6030886	plug MS400V5P CEE16A W 4,0-6,3A	1
6	6030887	plug MS400V5P CEE16A W 6,3-10,0A	1

PLUG

Item	Article no.	Description	Quantity
7	6032446	plug MS400V4P CEE16A WD 1,6-2,5A	1
7	6032447	plug MS400V4P CEE16A WD 12,5-16,0A	1
7	6032295	plug MS400V4P CEE16A WD 2,5-4,0A	1
7	6032289	plug MS400V4P CEE16A WD 4,0-6,3A	1
7	6032292	plug MS400V4P CEE16A WD 6,3-9,0A	1
7	6042190	plug MS400V5P CEE16A WDII 1,6-2,5A	1
7	6042194	plug MS400V5P CEE16A WDII 10,0-16,0A	1
7	6042191	plug MS400V5P CEE16A WDII 2,5-4,0A	1
7	6042192	plug MS400V5P CEE16A WDII 4,0-6,3A	1
7	6042193	plug MS400V5P CEE16A WDII 6,3-10,0A	1
7	6035911	plug MS400V5P CEE16A WD 9,0-12,5A	1
7	6003337	plug MS500V5P CEE16A WD 1,6-2,5A	1
7	6003336	plug MS500V5P CEE16A WD 2,5-4,0A	1
7	6003335	plug MS500V5P CEE16A WD 4,0-6,3A	1
7	6003334	plug MS500V5P CEE16A WD 6,3-9,0A	1
8	6072520	MCP 1,0-1,6A-T4-HA-ROT-WSK-CEE16-5PS VP.	1
8	6072521	MCP 1,6-2,4A-T4-HA-ROT-WSK-CEE16-5PS VP.	1
8	6072522	MCP 2,4-4,0A-T4-HA-ROT-WSK-CEE16-5PS VP.	1
8	6072523	MCP 4,0-6,0A-T4-HA-ROT-WSK-CEE16-5PS VP.	1
8	6072524	MCP 6,0-10A-T4-HA-ROT-WSK-CEE16-5PS VP.	1
8	6072525	MCP 9,0-12A-T4-HA-ROT-WSK-CEE16-5PS VP.	1
8	6072526	MCP 12-16A-T4-HA-ROT-WSK-CEE16-5PS VP.	1
9	6003267	plug CEE32A/400V/4P-6H	1
9	6039155	plug CEE32A/400V/5P-6H Phase inverter	1
9	6035895	plug CEE32A/500V/4P-7H AM-Top	1
9	6003010	plug CEE32A/500V/5P-7H	1
10	6072370	MCP 400V 1,6-2,5A-T4-H-ROT-CEE32-5PS VP.	1
10	6072369	MCP 400V 2,5-4,0A-T4-H-ROT-CEE32-5PS VP.	1
10	6072371	MCP 400V 4,0-6,3A-T4-H-ROT-CEE32-5PS VP.	1
10	6072398	MCP 400V 6,3-10A-T4-H-ROT-CEE32-5PS VP.	1
10	6072519	MCP 400V 10-16A-T4-H-ROT-CEE32-5PS VP.	1
10	6072399	MCP 400V 16-20A-T4-H-ROT-CEE32-5PS VP.	1
10	6072518	MCP 400V 20-25A-T4-H-ROT-CEE32-5PS VP.	1
10	6037649	plug.MS500V4P CEE32A WD 2,5-4,0A	1

PLUG

Item	Article no.	Description	Quantity
10	6041268	plug MS500V4P CEE32A WD 4,0-6,3A	1
10	6035244	plug MS500V5P CEE32A WD 1,6-2,5A	1
10	6034700	plug MS500V5P CEE32A WD 2,5-4,0A	1
10	6041556	plug MS500V5P CEE32A WD 4,0-6,3A	1
10	6002701	plug MS500V5P CEE32A WD 9,0-12,5A	1
10	6002700	plug MS500V5P CEE32A WD 12,5-16,0A	1
11	6003241	plug MS400V5P CEE32A WDSHA 10,0-14,0A	1
11	6003266	plug MS400V5P CEE32A WDSHA 3,7-5,5A	1
11	6003265	plug MS400V5P CEE32A WDSHA 5,5-8,0A	1
11	6003264	plug MS400V5P CEE32A WDSHA 8,0-11,5A	1
12	6003012	plug CEE63A/400V/5P-6H/IP67	1

cable for motor F12 / F13

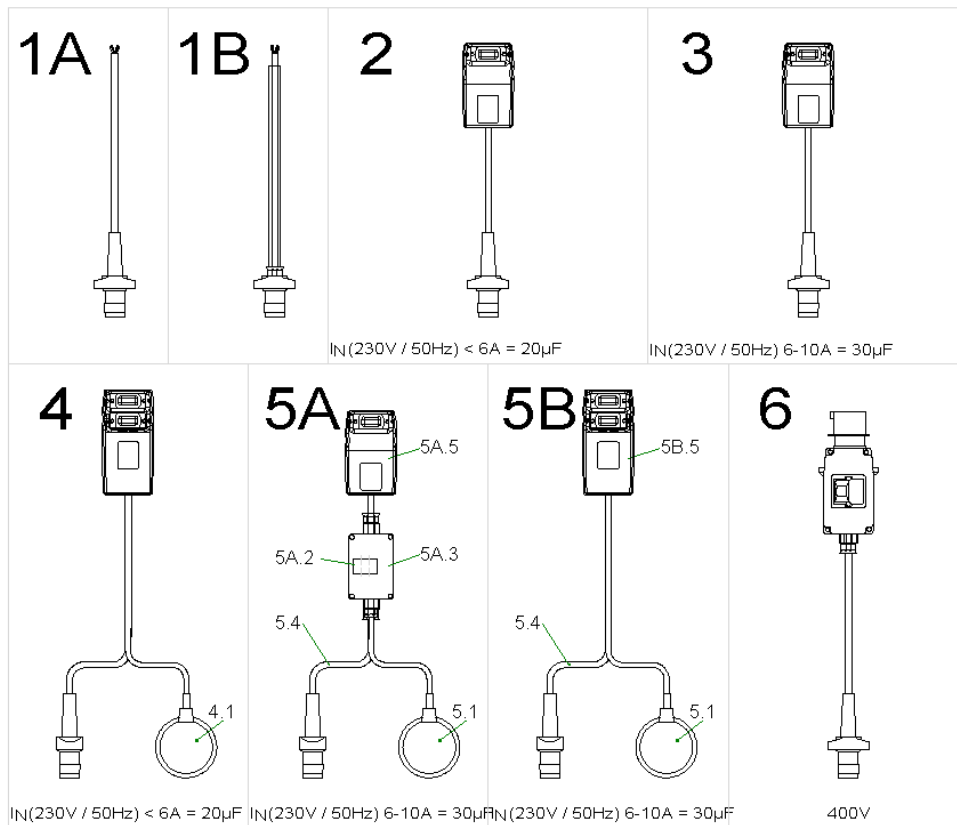

cable for motor F12 / F13

Item	Article no.	Description	Quantity
1A	6072559	cable 5m H07 4G1,5/coupling VP.	1
1A	6072560	cable 10m H07 4G1,5/coupling VP.	1
1A	6072561	cable 20m H07 4G1,5/coupling VP.	1
1A	6072562	cable 30m H07 4G1,5/coupling VP.	1
1A	6072563	cable 40m H07 4G1,5/coupling VP.	1
1A	6087533	cable 40m H07 4G1,5/coupling VP.	1
1B	6072564	cable 10m H07 4G1,5/coupl./hose VP. IN (230V / 50Hz) <6A - 20μF	1
2	6072565	switch box MCP 6A H 5M VP.	1
2	6072566	switch box MCP 6A H 10M VP.	1
2	6072567	switch box MCP 6A H 20M VP. IN (230V / 50Hz) 6-10A - 30μF	1
3	6072568	switch box MCP 10A H 5M VP.	1
3	6072569	switch box MCP 10A H 10M VP.	1
3	6072570	switch box MCP 10A H 20M VP. IN (230V / 50Hz) <6A - 20μF	1
4	6072571	switch box MCP 6A HA 5M VP.	1
4	6072572	switch box MCP 6A HA 10M VP.	1
4.1	6072582	float switch S-PS 10A 250V 10m NO VP	1
4	6072576	switch box MCP 6A HA 20M VP.	1
4.1	6072583	float switch S-PS 10A 250V 20m NO VP IN (230V / 50Hz) 6-10A - 30μF	1
5A		on request	1
5B	6072577	switch box MCP 10A HA 10M	1
5.1	6072582	float switch S-PS 10A 250V 10m NO VP	1
5A.2	6003341	contactor 5,5 kW 230 V, 50 Hz	1
5A.3	6031509	blank casing KS12/15ES KIT	1
5.4	6072560	cable 10m H07 4G1,5/coupling VP.	1
5A.5	6072330	MCP 10A-M-H-30μF-CEE7/7 VP.	1
5B.5	6072329	MCP 10A-M-HA-30μF-CEE7/7 VP für / for / pour 400V	1
6	6023991	switch box CEEM16W 2,5A, 10m SVA	1
6	6001253	switch box CEEM16W 4A, 10m SVA	1
6	6023992	switch box CEEM16W 6,3A, 20m SVA	1

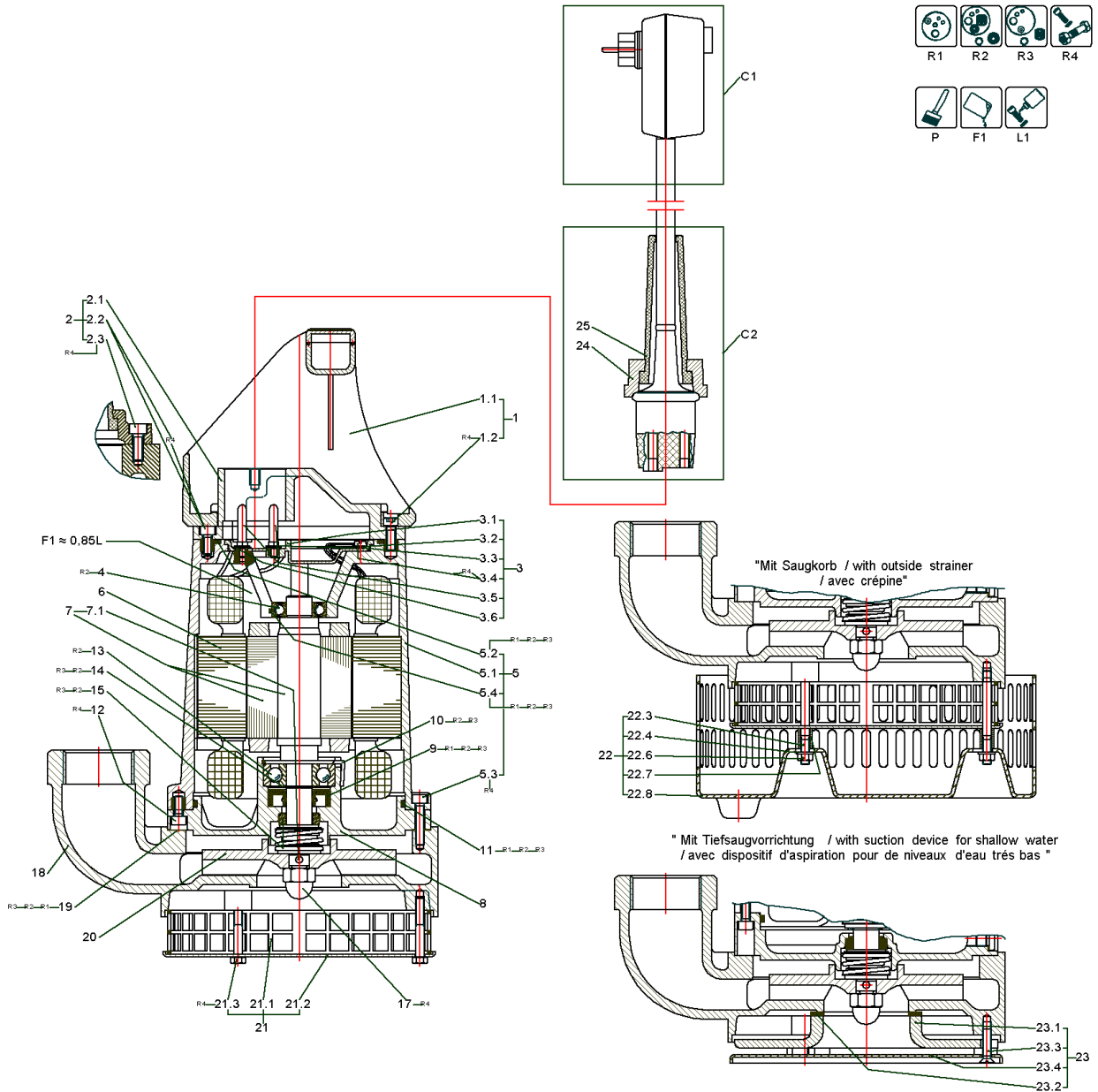

CONTRACTOR'S PUMP KE8 UNIT (6000079)

Item	Article no.	Description	Quantity
R1	6016271	Rep.Kit 1 KE7,8,9 Vit	1
R2	6016283	Rep.Kit 2 KE7,8,9 Vit	1
R3	6016296	Rep.Kit 3 KE7,8,9 Vit	1
R4	6016132	Screws KS8,9,12,14,15 KE7;8;9, F12 KIT	1
P	6042254	PAINT SPRAY Pantone334	1
P	6042255	colour 2K-paint IV80 pantone334C 250ml	1
P	6023614	Ceram C0 black 100 ml KIT	1
P	6020579	Ceram C0 black 250 ml KIT	1
P	6023485	Ceram C0 Black 500ml Kit	1
P	6019157	Ceram C0 black 1000 ml KIT	1
F1	6025460	medical white oil 1L KIT	1
L1	6080531	Loctite 243 5g flask VP:	1
L1	2096167	Loctite 243 50ml VP.	1

C1		PLUG	1
C2		cable for motor F12 / F13	1

1	6019566	handle 51.15480/1 plastics KIT	1
1.2		> screw M5x16 ISO4762 A2-70	1
1.1		> handle 51.15480/1 Akulon	1
2	6022949	motor cover D.95,8 51.17219 GG KIT	1
2.1		> motor cover D.95,8 51.17219 GG	1
2.2		> SCREW M5X12 ISO4762 A2-70	3
2.3		> screw M6x16 DIN912 A4 (10pc)	1
3	6001273	terminal board 54.3453 Makrolon KIT	1
3.1		> terminal board plastics Polycarbonat	1
3.5		> contact pin Ms	4
3.2		> lock washer 4 DIN7980 A4	1
3.3		> washer A4,3 DIN125 Ms	5
3.4		> screw M4x8 DIN84 Ms	1
3.6		> washer 4,3 DIN7349 Ms	1
4	6086141	ball bearing 6002 VP.	1
5	6021772	motor casing 52.3441 Al KIT	1
5.1		> motor casing 52.3441 Al	1

CONTRACTOR'S PUMP KE8 UNIT (6000079)

Item	Article no.	Description	Quantity
5.2		> o-ring ID.92,0x3,0 Viton	1
5.3		> screw M5x25 DIN912 A2-70	3
Note: für / for / pour KE			
5.3		> screw M5x45 ISO4762 A2-70	3
Note: für / for / pour KS			
5.4		> o-ring ID.32x1,78 Viton	1
Stator / stator / stator 50 Hz			
6	6023535	stator F12-2/6 230E 50Hz Ser11	1
6	6023532	stator F12-2/6 400 50Hz VN 01	1
6	6023533	stator F12-2/6 415 50Hz VN 01	1
6	6023534	stator F12-2/6 500 50Hz VN 01	1
alternativ / alternative / alternative			
6	6023531	stator F12-2/6 230 50Hz	1
Stator / stator / stator 60 Hz			
6	6023536	stator F12-2/6 230E 60Hz Ser11	1
6	6023537	stator F12-2/6 230/400 60Hz	1
7	6010022	rotor D.61,4x169 2/6 1.4021	1
7.1	6002743	slotted pin 4x6 DIN1473 1.4305	1
8	6017894	bearing end plate 53.3450/1 GG	1
9	6007489	shaft seal ring A15/37x10 DIN3760 NBR+A2	1
alternativ / alternative / alternative			
9	6019482	shaft seal ring A15x37x10 DIN3760 NBR LA	1
10	6004669	circlips 43,6x1,8 54.3438 FSt	1
11		o-ring ID.115,0x3,0 Viton -	1
12		SCREW M5X12 ISO4762 A2-70	3
13	6008975	ball bearing 6302	1
14	6002007	circlips 15x1 DIN471 FSt	1
15	6075396	mech shaft seal MG1/15-G64 BXPGG VP.	1
alternativ / alternative / alternative			
15	6003878	mechanical shaft seal MG1/15-G4 Q1Q1VGG	1
17	6002104	domet nut M10 DIN1587 A2	1
18	6012849	pump housing A G11/4 52.10520/1 Al	1
alternativ / alternative / alternative			
18	6021683	pump housing A G11/4 52.19207 Al/C0	1

CONTRACTOR'S PUMP KE8 UNIT (6000079)

Item	Article no.	Description	Quantity
18	6012850	pump housing A G11/4 52.10520/2 GG	1
18	6012848	pump hou. AG1 1/4 GG/C0 52.19207	1
18	6024442	pump housing A G11/4 52.19189 Abrasit	1
18	6022781	pump housing A G11/4 52.19189 Abrasit/C0	1
18	6012903	pump housing AG1 1/4 1.4581 52.16782VN00	1
19	6048831	flat gasket D.125/155 ARAMID/NBR (10pc)	1
		Laufrad / Impeller / Roue 50Hz	
20	6014013	impeller-W D.114 54.2392/1 GG	1
		alternativ / alternative / alternative	
20	6014005	impeller-W D.114 54.2392/1 GG/C0	1
20	6010632	impeller-W D.114 54.17902 Abrasit	1
20	6022790	impeller-W D.114 54.17902 Abrasit/C0	1
20	6014011	impeller-W D.114 54.2392/1 1.4581	1
		Laufrad / Impeller / Roue 60Hz	
20	6014009	impeller-W D.97 54.2114/1 GG	1
		alternativ / alternative / alternative	
20	6021758	Impeller-W D.97 54.2114/1 GG/C0	1
20	6022788	impeller-W D.97 54.17902 Abrasit	1
20	6022789	impeller-W D.97 54.17902 Abrasit/C0	1
20	6021647	impeller-W D.97 54.2114/1 1.4581	1
21	6001147	strainer 54.10534/1 1.4301 KIT	1
21.1		> strainer 26x155x2 1.4301	1
21.2		> base plate D.160x3 1,5 1.4301	1
21.3		> screw M5x35 ISO4014 A2-70	3
22	6032617	add on strainer KS 8/9 KIT	1
23	6021392	suction plate 53.17572 GG KIT	1
23.1		> suction plate 53.17572 GG	1
23.2	6004149	> flat gasket D.50/65x2 NBR	1
23.3	6002405	> screw M5x20 DIN963 A4	3
23.4		> base plate D.160x3 1,5 1.4301	1
24	6004828	cable gland Akulon	1
25	6003824	cable peotection NBR 87x30 mm	1

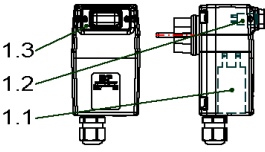
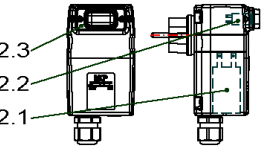
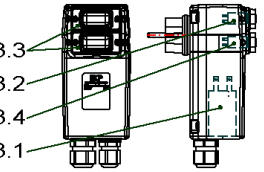
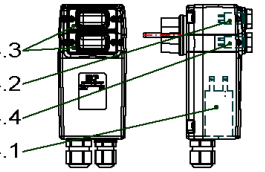
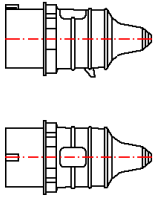
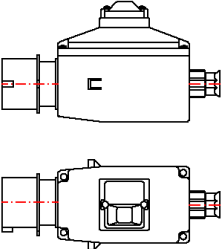
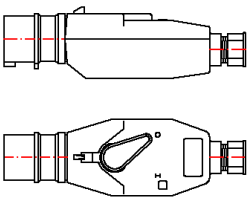
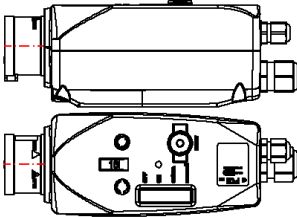
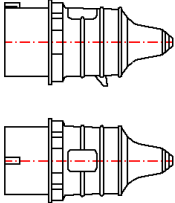
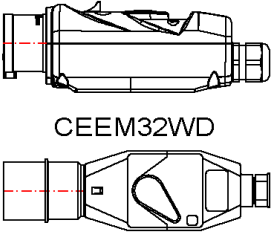
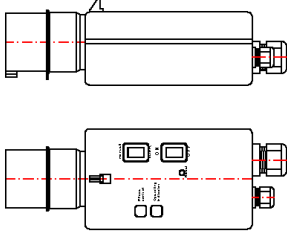
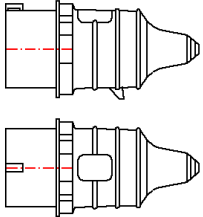
<p>1 MCP 6A-M-H-20μF ~ 230V</p>  <p>$I_N(230V / 50Hz) < 6A = 20\mu F$</p>	<p>2 MCP 10A-M-H-30μF ~ 230V</p>  <p>$I_N(230V / 50Hz) 6-10A = 30\mu F$</p>	<p>3 MCP 6A-M-HA-20μF ~ 230V</p>  <p>$I_N(230V / 50Hz) < 6A = 20\mu F$</p>	<p>4 MCP 10A-M-HA-30μF ~ 230V</p>  <p>$I_N(230V / 50Hz) 6-10A = 30\mu F$</p>
<p>5 CEE16A</p> 	<p>6 CEEM16W</p> 	<p>7 CEEM16WD</p> 	<p>8 MCP T4-HA-ROT-WSK CEE16-5PS</p> 
<p>9 CEE32A</p> 	<p>10 MCP 10-16A-T4-H-ROT CEE32-5PS</p>  <p>CEEM32WD</p>	<p>11 CEEM32WDSHA</p> 	<p>12 CEE63A</p> 

PLUG

Item	Article no.	Description	Quantity
		IN (230V / 50Hz) <6A - 20μF	
1	6072332	MCP 6A-M-H-20μF-CEE7/7 VP.	1
1.1	6071702	capacitor 400V 20μF MCP VP.	1
1.2	6071704	protection switch 6A MCP VP.	1
1.3	6071707	protecting cap MCP VP.	1
		IN (230V / 50Hz) 6-10A - 30μF	
2	6072330	MCP 10A-M-H-30μF-CEE7/7 VP.	1
2.1	6071703	capacitor 400V 30μF MCP VP.	1
2.2	6071705	protection switch 10A MCP VP.	1
2.3	6071707	protecting cap MCP VP.	1
		IN (230V / 50Hz) <6A - 20μF	
3	6072331	MCP 6A-M-HA-20μF-CEE7/7 VP.	1
3.1	6071702	capacitor 400V 20μF MCP VP.	1
3.2	6071704	protection switch 6A MCP VP.	1
3.3	6071707	protecting cap MCP VP.	2
3.4	6071706	switch on/out MCP VP.	1
		IN (230V / 50Hz) 6-10A - 30μF	
4	6072329	MCP 10A-M-HA-30μF-CEE7/7 VP	1
4.1	6071703	capacitor 400V 30μF MCP VP.	1
4.2	6071705	protection switch 10A MCP VP.	1
4.3	6071707	protecting cap MCP VP.	2
4.4	6071706	switch on/out MCP VP.	1
5	6003000	plug CEE16A/400V 60Hz/5P-11h	1
5	6003248	plug CEE16A/400V/4P-6H	1
5	6003009	plug CEE16A/400V/5P-6H	1
5	6039156	plug CEE16A/400V/5P-6H Phase inverter	1
5	6035231	plug CEE16A/400V/7P-6H	1
5	6003011	plug CEE16A/500V/5P-7H	1
6	6030883	plug MS400V5P CEE16A W 1,0-1,6A	1
6	6030884	plug MS400V5P CEE16A W 1,6-2,5A	1
6	6030888	plug MS400V5P CEE16A W 10,0-16,0A	1
6	6030885	plug MS400V5P CEE16A W 2,5-4,0A	1
6	6030886	plug MS400V5P CEE16A W 4,0-6,3A	1
6	6030887	plug MS400V5P CEE16A W 6,3-10,0A	1

PLUG

Item	Article no.	Description	Quantity
7	6032446	plug MS400V4P CEE16A WD 1,6-2,5A	1
7	6032447	plug MS400V4P CEE16A WD 12,5-16,0A	1
7	6032295	plug MS400V4P CEE16A WD 2,5-4,0A	1
7	6032289	plug MS400V4P CEE16A WD 4,0-6,3A	1
7	6032292	plug MS400V4P CEE16A WD 6,3-9,0A	1
7	6042190	plug MS400V5P CEE16A WDII 1,6-2,5A	1
7	6042194	plug MS400V5P CEE16A WDII 10,0-16,0A	1
7	6042191	plug MS400V5P CEE16A WDII 2,5-4,0A	1
7	6042192	plug MS400V5P CEE16A WDII 4,0-6,3A	1
7	6042193	plug MS400V5P CEE16A WDII 6,3-10,0A	1
7	6035911	plug MS400V5P CEE16A WD 9,0-12,5A	1
7	6003337	plug MS500V5P CEE16A WD 1,6-2,5A	1
7	6003336	plug MS500V5P CEE16A WD 2,5-4,0A	1
7	6003335	plug MS500V5P CEE16A WD 4,0-6,3A	1
7	6003334	plug MS500V5P CEE16A WD 6,3-9,0A	1
8	6072520	MCP 1,0-1,6A-T4-HA-ROT-WSK-CEE16-5PS VP.	1
8	6072521	MCP 1,6-2,4A-T4-HA-ROT-WSK-CEE16-5PS VP.	1
8	6072522	MCP 2,4-4,0A-T4-HA-ROT-WSK-CEE16-5PS VP.	1
8	6072523	MCP 4,0-6,0A-T4-HA-ROT-WSK-CEE16-5PS VP.	1
8	6072524	MCP 6,0-10A-T4-HA-ROT-WSK-CEE16-5PS VP.	1
8	6072525	MCP 9,0-12A-T4-HA-ROT-WSK-CEE16-5PS VP.	1
8	6072526	MCP 12-16A-T4-HA-ROT-WSK-CEE16-5PS VP.	1
9	6003267	plug CEE32A/400V/4P-6H	1
9	6039155	plug CEE32A/400V/5P-6H Phase inverter	1
9	6035895	plug CEE32A/500V/4P-7H AM-Top	1
9	6003010	plug CEE32A/500V/5P-7H	1
10	6072370	MCP 400V 1,6-2,5A-T4-H-ROT-CEE32-5PS VP.	1
10	6072369	MCP 400V 2,5-4,0A-T4-H-ROT-CEE32-5PS VP.	1
10	6072371	MCP 400V 4,0-6,3A-T4-H-ROT-CEE32-5PS VP.	1
10	6072398	MCP 400V 6,3-10A-T4-H-ROT-CEE32-5PS VP.	1
10	6072519	MCP 400V 10-16A-T4-H-ROT-CEE32-5PS VP.	1
10	6072399	MCP 400V 16-20A-T4-H-ROT-CEE32-5PS VP.	1
10	6072518	MCP 400V 20-25A-T4-H-ROT-CEE32-5PS VP.	1
10	6037649	plug.MS500V4P CEE32A WD 2,5-4,0A	1

PLUG

Item	Article no.	Description	Quantity
10	6041268	plug MS500V4P CEE32A WD 4,0-6,3A	1
10	6035244	plug MS500V5P CEE32A WD 1,6-2,5A	1
10	6034700	plug MS500V5P CEE32A WD 2,5-4,0A	1
10	6041556	plug MS500V5P CEE32A WD 4,0-6,3A	1
10	6002701	plug MS500V5P CEE32A WD 9,0-12,5A	1
10	6002700	plug MS500V5P CEE32A WD 12,5-16,0A	1
11	6003241	plug MS400V5P CEE32A WDSHA 10,0-14,0A	1
11	6003266	plug MS400V5P CEE32A WDSHA 3,7-5,5A	1
11	6003265	plug MS400V5P CEE32A WDSHA 5,5-8,0A	1
11	6003264	plug MS400V5P CEE32A WDSHA 8,0-11,5A	1
12	6003012	plug CEE63A/400V/5P-6H/IP67	1

cable for motor F12 / F13

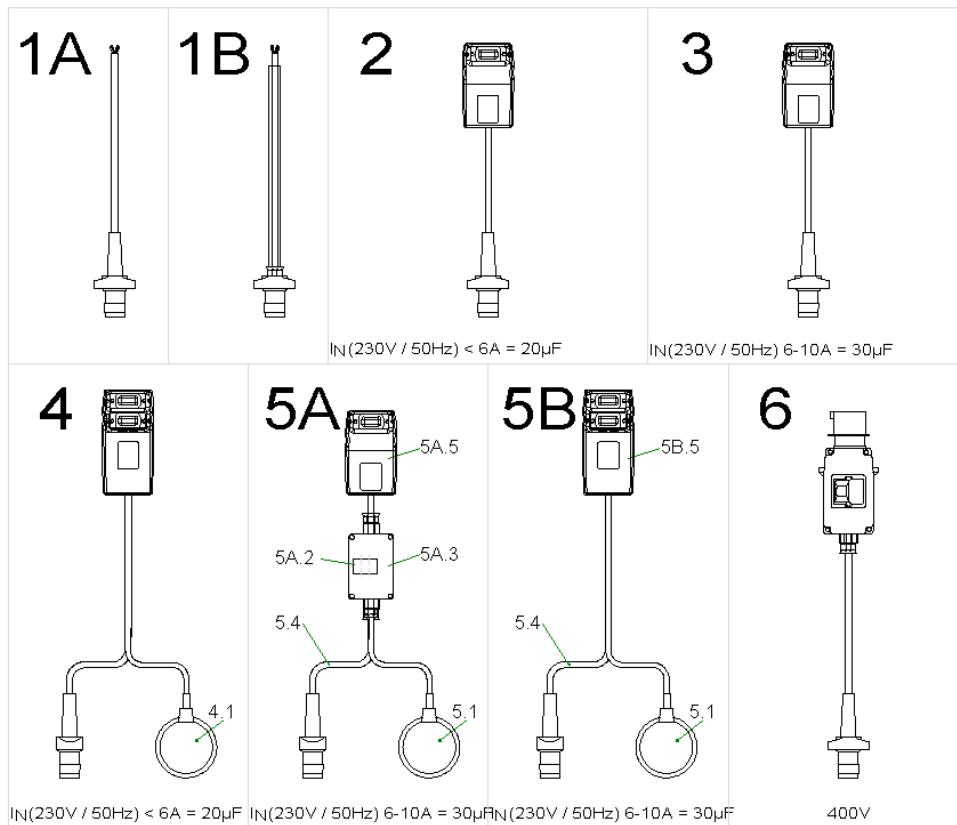

cable for motor F12 / F13

Item	Article no.	Description	Quantity
1A	6072559	cable 5m H07 4G1,5/coupling VP.	1
1A	6072560	cable 10m H07 4G1,5/coupling VP.	1
1A	6072561	cable 20m H07 4G1,5/coupling VP.	1
1A	6072562	cable 30m H07 4G1,5/coupling VP.	1
1A	6072563	cable 40m H07 4G1,5/coupling VP.	1
1A	6087533	cable 40m H07 4G1,5/coupling VP.	1
1B	6072564	cable 10m H07 4G1,5/coupl./hose VP. IN (230V / 50Hz) <6A - 20μF	1
2	6072565	switch box MCP 6A H 5M VP.	1
2	6072566	switch box MCP 6A H 10M VP.	1
2	6072567	switch box MCP 6A H 20M VP. IN (230V / 50Hz) 6-10A - 30μF	1
3	6072568	switch box MCP 10A H 5M VP.	1
3	6072569	switch box MCP 10A H 10M VP.	1
3	6072570	switch box MCP 10A H 20M VP. IN (230V / 50Hz) <6A - 20μF	1
4	6072571	switch box MCP 6A HA 5M VP.	1
4	6072572	switch box MCP 6A HA 10M VP.	1
4.1	6072582	float switch S-PS 10A 250V 10m NO VP	1
4	6072576	switch box MCP 6A HA 20M VP.	1
4.1	6072583	float switch S-PS 10A 250V 20m NO VP IN (230V / 50Hz) 6-10A - 30μF	1
5A		on request	1
5B	6072577	switch box MCP 10A HA 10M	1
5.1	6072582	float switch S-PS 10A 250V 10m NO VP	1
5A.2	6003341	contactor 5,5 kW 230 V, 50 Hz	1
5A.3	6031509	blank casing KS12/15ES KIT	1
5.4	6072560	cable 10m H07 4G1,5/coupling VP.	1
5A.5	6072330	MCP 10A-M-H-30μF-CEE7/7 VP.	1
5B.5	6072329	MCP 10A-M-HA-30μF-CEE7/7 VP für / for / pour 400V	1
6	6023991	switch box CEEM16W 2,5A, 10m SVA	1
6	6001253	switch box CEEM16W 4A, 10m SVA	1
6	6023992	switch box CEEM16W 6,3A, 20m SVA	1

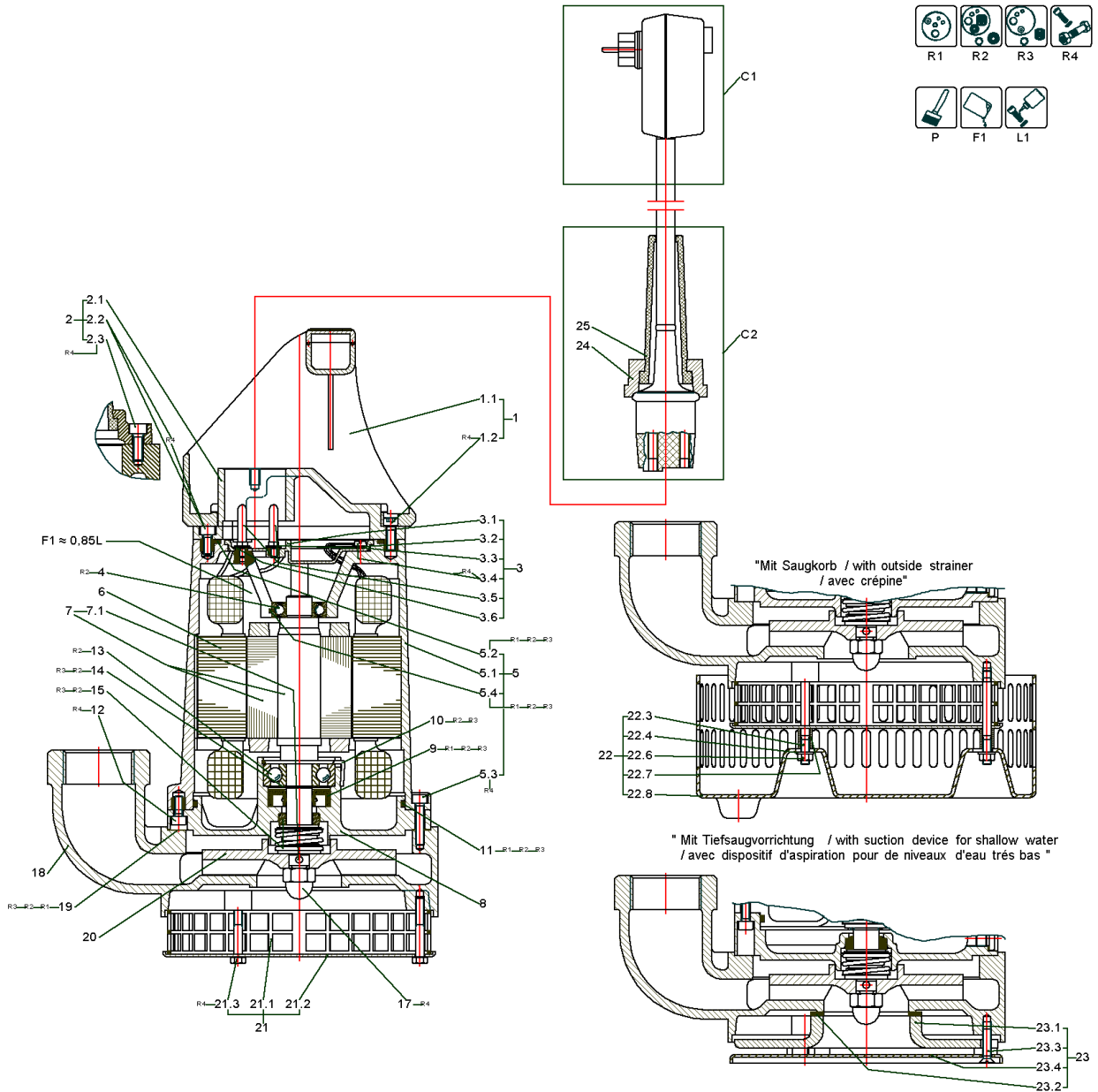

CONTRACTOR'S PUMP KE8GG UNIT (6000080)

Item	Article no.	Description	Quantity
R1	6016271	Rep.Kit 1 KE7,8,9 Vit	1
R2	6016283	Rep.Kit 2 KE7,8,9 Vit	1
R3	6016296	Rep.Kit 3 KE7,8,9 Vit	1
R4	6016132	Screws KS8,9,12,14,15 KE7;8;9, F12 KIT	1
P	6042254	PAINT SPRAY Pantone334	1
P	6042255	colour 2K-paint IV80 pantone334C 250ml	1
P	6023614	Ceram C0 black 100 ml KIT	1
P	6020579	Ceram C0 black 250 ml KIT	1
P	6023485	Ceram C0 Black 500ml Kit	1
P	6019157	Ceram C0 black 1000 ml KIT	1
F1	6025460	medical white oil 1L KIT	1
L1	6080531	Loctite 243 5g flask VP:	1
L1	2096167	Loctite 243 50ml VP.	1

C1		PLUG	1
C2		cable for motor F12 / F13	1

1	6019566	handle 51.15480/1 plastics KIT	1
1.2		> screw M5x16 ISO4762 A2-70	1
1.1		> handle 51.15480/1 Akulon	1
2	6022949	motor cover D.95,8 51.17219 GG KIT	1
2.1		> motor cover D.95,8 51.17219 GG	1
2.2		> SCREW M5X12 ISO4762 A2-70	3
2.3		> screw M6x16 DIN912 A4 (10pc)	1
3	6001273	terminal board 54.3453 Makrolon KIT	1
3.1		> terminal board plastics Polycarbonat	1
3.5		> contact pin Ms	4
3.2		> lock washer 4 DIN7980 A4	1
3.3		> washer A4,3 DIN125 Ms	5
3.4		> screw M4x8 DIN84 Ms	1
3.6		> washer 4,3 DIN7349 Ms	1
4	6086141	ball bearing 6002 VP.	1
5	6022378	motor casing 52.2924/1E GG KIT	1
5.1		> motor casing 52.2924/1 GG	1

CONTRACTOR'S PUMP KE8GG UNIT (6000080)

Item	Article no.	Description	Quantity
5.2		> o-ring ID.92,0x3,0 Viton	1
5.3		> screw M5x25 DIN912 A2-70	3
5.3		> screw M5x45 ISO4762 A2-70	3
Note: für / for / pour KS			
5.4		> o-ring ID.32x1,78 Viton	1
		Stator / stator / stator 50 Hz	
6	6023535	stator F12-2/6 230E 50Hz Ser11	1
6	6023532	stator F12-2/6 400 50Hz VN 01	1
6	6023533	stator F12-2/6 415 50Hz VN 01	1
6	6023534	stator F12-2/6 500 50Hz VN 01	1
		alternativ / alternative / alternative	
6	6023531	stator F12-2/6 230 50Hz	1
		Stator / stator / stator 60 Hz	
6	6023536	stator F12-2/6 230E 60Hz Ser11	1
6	6023537	stator F12-2/6 230/400 60Hz	1
7	6010022	rotor D.61,4x169 2/6 1.4021	1
7.1	6002743	slotted pin 4x6 DIN1473 1.4305	1
8	6017894	bearing end plate 53.3450/1 GG	1
9	6007489	shaft seal ring A15/37x10 DIN3760 NBR+A2	1
		alternativ / alternative / alternative	
9	6019482	shaft seal ring A15x37x10 DIN3760 NBR LA	1
10	6004669	circlips 43,6x1,8 54.3438 FSt	1
11		o-ring ID.115,0x3,0 Viton -	1
12		SCREW M5X12 ISO4762 A2-70	3
13	6008975	ball bearing 6302	1
14	6002007	circlips 15x1 DIN471 FSt	1
15	6075396	mech shaft seal MG1/15-G64 BXPGG VP.	1
		alternativ / alternative / alternative	
15	6003878	mechanical shaft seal MG1/15-G4 Q1Q1VGG	1
17	6002104	domet nut M10 DIN1587 A2	1
18	6012850	pump housing A G11/4 52.10520/2 GG	1
		alternativ / alternative / alternative	
18	6012848	pump hou. AG1 1/4 GG/C0 52.19207	1
18	6024442	pump housing A G11/4 52.19189 Abrasit	1

CONTRACTOR'S PUMP KE8GG UNIT (6000080)

Item	Article no.	Description	Quantity
18	6022781	pump housing A G11/4 52.19189 Abrasit/CO	1
18	6012903	pump housing AG1 1/4 1.4581 52.16782VN00	1
19	6048831	flat gasket D.125/155 ARAMID/NBR (10pc)	1
		Laufrad / Impeller / Roue 50Hz	
20	6014013	impeller-W D.114 54.2392/1 GG	1
		alternativ / alternative / alternative	
20	6014005	impeller-W D.114 54.2392/1 GG/CO	1
20	6010632	impeller-W D.114 54.17902 Abrasit	1
20	6022790	impeller-W D.114 54.17902 Abrasit/CO	1
20	6014011	impeller-W D.114 54.2392/1 1.4581	1
		Laufrad / Impeller / Roue 60Hz	
20	6014009	impeller-W D.97 54.2114/1 GG	1
		alternativ / alternative / alternative	
20	6021758	Impeller-W D.97 54.2114/1 GG/CO	1
20	6022788	impeller-W D.97 54.17902 Abrasit	1
20	6022789	impeller-W D.97 54.17902 Abrasit/CO	1
20	6021647	impeller-W D.97 54.2114/1 1.4581	1
21	6001147	strainer 54.10534/1 1.4301 KIT	1
21.1		> strainer 26x155x2 1.4301	1
21.2		> base plate D.160x3 1,5 1.4301	1
21.3		> screw M5x35 ISO4014 A2-70	3
22	6032617	add on strainer KS 8/9 KIT	1
23	6021392	suction plate 53.17572 GG KIT	1
23.1		> suction plate 53.17572 GG	1
23.2	6004149	> flat gasket D.50/65x2 NBR	1
23.3	6002405	> screw M5x20 DIN963 A4	3
23.4		> base plate D.160x3 1,5 1.4301	1
24	6004828	cable gland Akulon	1
25	6003824	cable peotection NBR 87x30 mm	1

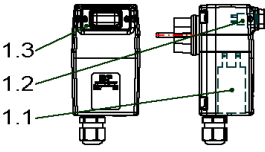
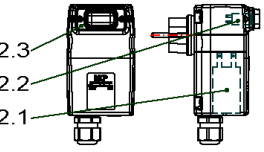
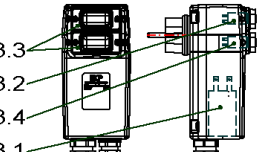
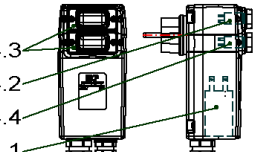
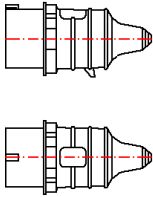
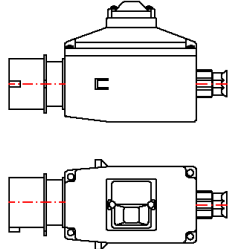
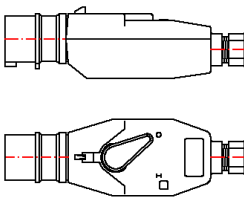
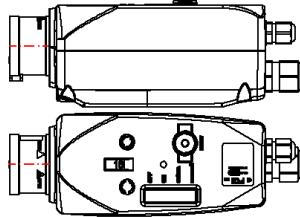
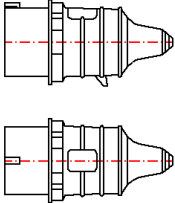
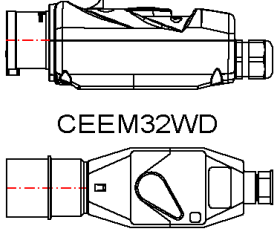
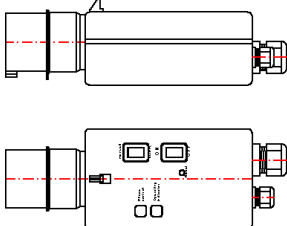
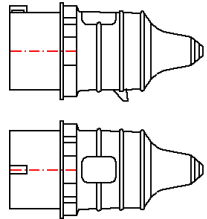
<p>1 MCP 6A-M-H-20μF ~ 230V</p>  <p>$I_N(230V / 50Hz) < 6A = 20\mu F$</p>	<p>2 MCP 10A-M-H-30μF ~ 230V</p>  <p>$I_N(230V / 50Hz) 6-10A = 30\mu F$</p>	<p>3 MCP 6A-M-HA-20μF ~ 230V</p>  <p>$I_N(230V / 50Hz) < 6A = 20\mu F$</p>	<p>4 MCP 10A-M-HA-30μF ~ 230V</p>  <p>$I_N(230V / 50Hz) 6-10A = 30\mu F$</p>
<p>5 CEE16A</p> 	<p>6 CEEM16W</p> 	<p>7 CEEM16WD</p> 	<p>8 MCP T4-HA-ROT-WSK CEE16-5PS</p> 
<p>9 CEE32A</p> 	<p>10 MCP 10-16A-T4-H-ROT CEE32-5PS</p>  <p>CEEM32WD</p>	<p>11 CEEM32WDSHA</p> 	<p>12 CEE63A</p> 

PLUG

Item	Article no.	Description	Quantity
		IN (230V / 50Hz) <6A - 20μF	
1	6072332	MCP 6A-M-H-20μF-CEE7/7 VP.	1
1.1	6071702	capacitor 400V 20μF MCP VP.	1
1.2	6071704	protection switch 6A MCP VP.	1
1.3	6071707	protecting cap MCP VP.	1
		IN (230V / 50Hz) 6-10A - 30μF	
2	6072330	MCP 10A-M-H-30μF-CEE7/7 VP.	1
2.1	6071703	capacitor 400V 30μF MCP VP.	1
2.2	6071705	protection switch 10A MCP VP.	1
2.3	6071707	protecting cap MCP VP.	1
		IN (230V / 50Hz) <6A - 20μF	
3	6072331	MCP 6A-M-HA-20μF-CEE7/7 VP.	1
3.1	6071702	capacitor 400V 20μF MCP VP.	1
3.2	6071704	protection switch 6A MCP VP.	1
3.3	6071707	protecting cap MCP VP.	2
3.4	6071706	switch on/out MCP VP.	1
		IN (230V / 50Hz) 6-10A - 30μF	
4	6072329	MCP 10A-M-HA-30μF-CEE7/7 VP	1
4.1	6071703	capacitor 400V 30μF MCP VP.	1
4.2	6071705	protection switch 10A MCP VP.	1
4.3	6071707	protecting cap MCP VP.	2
4.4	6071706	switch on/out MCP VP.	1
5	6003000	plug CEE16A/400V 60Hz/5P-11h	1
5	6003248	plug CEE16A/400V/4P-6H	1
5	6003009	plug CEE16A/400V/5P-6H	1
5	6039156	plug CEE16A/400V/5P-6H Phase inverter	1
5	6035231	plug CEE16A/400V/7P-6H	1
5	6003011	plug CEE16A/500V/5P-7H	1
6	6030883	plug MS400V5P CEE16A W 1,0-1,6A	1
6	6030884	plug MS400V5P CEE16A W 1,6-2,5A	1
6	6030888	plug MS400V5P CEE16A W 10,0-16,0A	1
6	6030885	plug MS400V5P CEE16A W 2,5-4,0A	1
6	6030886	plug MS400V5P CEE16A W 4,0-6,3A	1
6	6030887	plug MS400V5P CEE16A W 6,3-10,0A	1

PLUG

Item	Article no.	Description	Quantity
7	6032446	plug MS400V4P CEE16A WD 1,6-2,5A	1
7	6032447	plug MS400V4P CEE16A WD 12,5-16,0A	1
7	6032295	plug MS400V4P CEE16A WD 2,5-4,0A	1
7	6032289	plug MS400V4P CEE16A WD 4,0-6,3A	1
7	6032292	plug MS400V4P CEE16A WD 6,3-9,0A	1
7	6042190	plug MS400V5P CEE16A WDII 1,6-2,5A	1
7	6042194	plug MS400V5P CEE16A WDII 10,0-16,0A	1
7	6042191	plug MS400V5P CEE16A WDII 2,5-4,0A	1
7	6042192	plug MS400V5P CEE16A WDII 4,0-6,3A	1
7	6042193	plug MS400V5P CEE16A WDII 6,3-10,0A	1
7	6035911	plug MS400V5P CEE16A WD 9,0-12,5A	1
7	6003337	plug MS500V5P CEE16A WD 1,6-2,5A	1
7	6003336	plug MS500V5P CEE16A WD 2,5-4,0A	1
7	6003335	plug MS500V5P CEE16A WD 4,0-6,3A	1
7	6003334	plug MS500V5P CEE16A WD 6,3-9,0A	1
8	6072520	MCP 1,0-1,6A-T4-HA-ROT-WSK-CEE16-5PS VP.	1
8	6072521	MCP 1,6-2,4A-T4-HA-ROT-WSK-CEE16-5PS VP.	1
8	6072522	MCP 2,4-4,0A-T4-HA-ROT-WSK-CEE16-5PS VP.	1
8	6072523	MCP 4,0-6,0A-T4-HA-ROT-WSK-CEE16-5PS VP.	1
8	6072524	MCP 6,0-10A-T4-HA-ROT-WSK-CEE16-5PS VP.	1
8	6072525	MCP 9,0-12A-T4-HA-ROT-WSK-CEE16-5PS VP.	1
8	6072526	MCP 12-16A-T4-HA-ROT-WSK-CEE16-5PS VP.	1
9	6003267	plug CEE32A/400V/4P-6H	1
9	6039155	plug CEE32A/400V/5P-6H Phase inverter	1
9	6035895	plug CEE32A/500V/4P-7H AM-Top	1
9	6003010	plug CEE32A/500V/5P-7H	1
10	6072370	MCP 400V 1,6-2,5A-T4-H-ROT-CEE32-5PS VP.	1
10	6072369	MCP 400V 2,5-4,0A-T4-H-ROT-CEE32-5PS VP.	1
10	6072371	MCP 400V 4,0-6,3A-T4-H-ROT-CEE32-5PS VP.	1
10	6072398	MCP 400V 6,3-10A-T4-H-ROT-CEE32-5PS VP.	1
10	6072519	MCP 400V 10-16A-T4-H-ROT-CEE32-5PS VP.	1
10	6072399	MCP 400V 16-20A-T4-H-ROT-CEE32-5PS VP.	1
10	6072518	MCP 400V 20-25A-T4-H-ROT-CEE32-5PS VP.	1
10	6037649	plug.MS500V4P CEE32A WD 2,5-4,0A	1

PLUG

Item	Article no.	Description	Quantity
10	6041268	plug MS500V4P CEE32A WD 4,0-6,3A	1
10	6035244	plug MS500V5P CEE32A WD 1,6-2,5A	1
10	6034700	plug MS500V5P CEE32A WD 2,5-4,0A	1
10	6041556	plug MS500V5P CEE32A WD 4,0-6,3A	1
10	6002701	plug MS500V5P CEE32A WD 9,0-12,5A	1
10	6002700	plug MS500V5P CEE32A WD 12,5-16,0A	1
11	6003241	plug MS400V5P CEE32A WDSHA 10,0-14,0A	1
11	6003266	plug MS400V5P CEE32A WDSHA 3,7-5,5A	1
11	6003265	plug MS400V5P CEE32A WDSHA 5,5-8,0A	1
11	6003264	plug MS400V5P CEE32A WDSHA 8,0-11,5A	1
12	6003012	plug CEE63A/400V/5P-6H/IP67	1

cable for motor F12 / F13

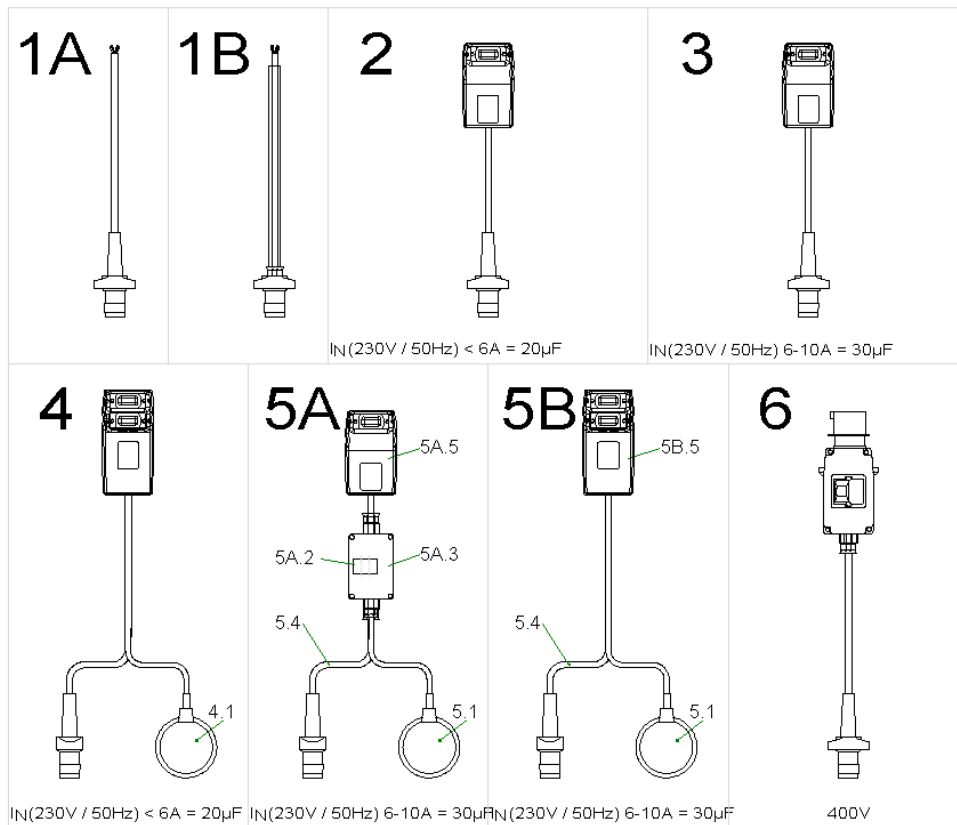

cable for motor F12 / F13

Item	Article no.	Description	Quantity
1A	6072559	cable 5m H07 4G1,5/coupling VP.	1
1A	6072560	cable 10m H07 4G1,5/coupling VP.	1
1A	6072561	cable 20m H07 4G1,5/coupling VP.	1
1A	6072562	cable 30m H07 4G1,5/coupling VP.	1
1A	6072563	cable 40m H07 4G1,5/coupling VP.	1
1A	6087533	cable 40m H07 4G1,5/coupling VP.	1
1B	6072564	cable 10m H07 4G1,5/coupl./hose VP. IN (230V / 50Hz) <6A - 20μF	1
2	6072565	switch box MCP 6A H 5M VP.	1
2	6072566	switch box MCP 6A H 10M VP.	1
2	6072567	switch box MCP 6A H 20M VP. IN (230V / 50Hz) 6-10A - 30μF	1
3	6072568	switch box MCP 10A H 5M VP.	1
3	6072569	switch box MCP 10A H 10M VP.	1
3	6072570	switch box MCP 10A H 20M VP. IN (230V / 50Hz) <6A - 20μF	1
4	6072571	switch box MCP 6A HA 5M VP.	1
4	6072572	switch box MCP 6A HA 10M VP.	1
4.1	6072582	float switch S-PS 10A 250V 10m NO VP	1
4	6072576	switch box MCP 6A HA 20M VP.	1
4.1	6072583	float switch S-PS 10A 250V 20m NO VP IN (230V / 50Hz) 6-10A - 30μF	1
5A		on request	1
5B	6072577	switch box MCP 10A HA 10M	1
5.1	6072582	float switch S-PS 10A 250V 10m NO VP	1
5A.2	6003341	contactor 5,5 kW 230 V, 50 Hz	1
5A.3	6031509	blank casing KS12/15ES KIT	1
5.4	6072560	cable 10m H07 4G1,5/coupling VP.	1
5A.5	6072330	MCP 10A-M-H-30μF-CEE7/7 VP.	1
5B.5	6072329	MCP 10A-M-HA-30μF-CEE7/7 VP für / for / pour 400V	1
6	6023991	switch box CEEM16W 2,5A, 10m SVA	1
6	6001253	switch box CEEM16W 4A, 10m SVA	1
6	6023992	switch box CEEM16W 6,3A, 20m SVA	1

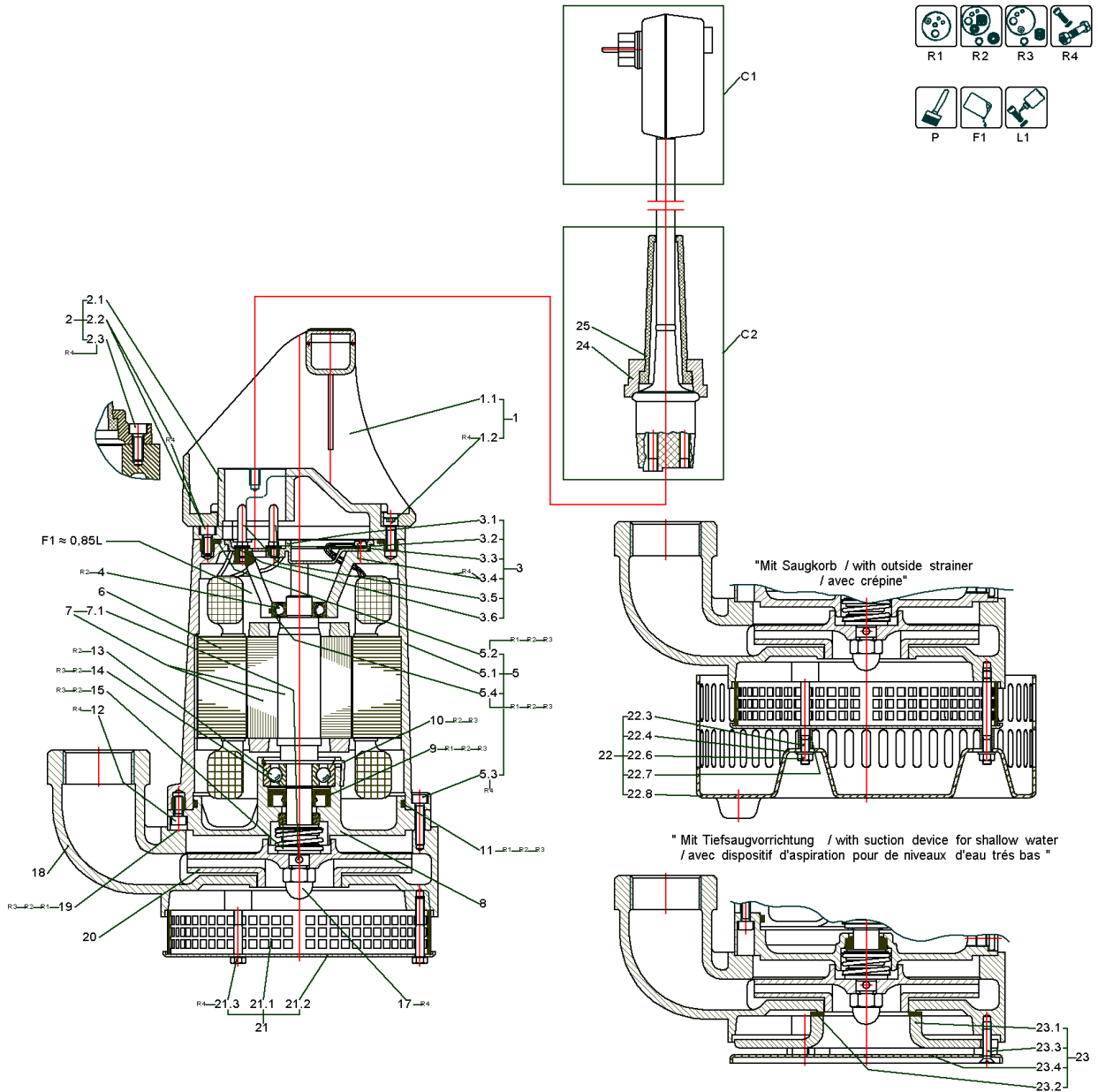

CONTRACTOR'S PUMP KE9 UNIT (6000081)

Item	Article no.	Description	Quantity
R1	6016271	Rep.Kit 1 KE7,8,9 Vit	1
R2	6016283	Rep.Kit 2 KE7,8,9 Vit	1
R3	6016296	Rep.Kit 3 KE7,8,9 Vit	1
R4	6016132	Screws KS8,9,12,14,15 KE7;8;9, F12 KIT	1
P	6042254	PAINT SPRAY Pantone334	1
P	6042255	colour 2K-paint IV80 pantone334C 250ml	1
P	6023614	Ceram C0 black 100 ml KIT	1
P	6020579	Ceram C0 black 250 ml KIT	1
P	6023485	Ceram C0 Black 500ml Kit	1
P	6019157	Ceram C0 black 1000 ml KIT	1
F1	6025460	medical white oil 1L KIT	1
L1	6080531	Loctite 243 5g flask VP:	1
L1	2096167	Loctite 243 50ml VP.	1

C1		PLUG	1
C2		cable for motor F12 / F13	1

1	6019566	handle 51.15480/1 plastics KIT	1
1.2		> screw M5x16 ISO4762 A2-70	1
1.1		> handle 51.15480/1 Akulon	1
2	6022949	motor cover D.95,8 51.17219 GG KIT	1
2.1		> motor cover D.95,8 51.17219 GG	1
2.2		> SCREW M5X12 ISO4762 A2-70	3
2.3		> screw M6x16 DIN912 A4 (10pc)	1
3	6001273	terminal board 54.3453 Makrolon KIT	1
3.1		> terminal board plastics Polycarbonat	1
3.5		> contact pin Ms	4
3.2		> lock washer 4 DIN7980 A4	1
3.3		> washer A4,3 DIN125 Ms	5
3.4		> screw M4x8 DIN84 Ms	1
3.6		> washer 4,3 DIN7349 Ms	1
4	6086141	ball bearing 6002 VP.	1
5	6021772	motor casing 52.3441 Al KIT	1
5.1		> motor casing 52.3441 Al	1

CONTRACTOR'S PUMP KE9 UNIT (6000081)

Item	Article no.	Description	Quantity
5.2		> o-ring ID.92,0x3,0 Viton	1
5.3		> screw M5x25 DIN912 A2-70	3
Note: für / for / pour KE			
5.3		> screw M5x45 ISO4762 A2-70	3
Note: für / for / pour KS			
5.4		> o-ring ID.32x1,78 Viton	1
Stator / stator / stator 50 Hz			
6	6023535	stator F12-2/6 230E 50Hz Ser11	1
6	6023532	stator F12-2/6 400 50Hz VN 01	1
6	6023533	stator F12-2/6 415 50Hz VN 01	1
6	6023534	stator F12-2/6 500 50Hz VN 01	1
alternativ / alternative / alternative			
6	6023531	stator F12-2/6 230 50Hz	1
Stator / stator / stator 60 Hz			
6	6023536	stator F12-2/6 230E 60Hz Ser11	1
6	6023537	stator F12-2/6 230/400 60Hz	1
7	6010022	rotor D.61,4x169 2/6 1.4021	1
7.1	6002743	slotted pin 4x6 DIN1473 1.4305	1
8	6017894	bearing end plate 53.3450/1 GG	1
9	6007489	shaft seal ring A15/37x10 DIN3760 NBR+A2	1
alternativ / alternative / alternative			
9	6019482	shaft seal ring A15x37x10 DIN3760 NBR LA	1
10	6004669	circlips 43,6x1,8 54.3438 FSt	1
11		o-ring ID.115,0x3,0 Viton -	1
12		SCREW M5X12 ISO4762 A2-70	3
13	6008975	ball bearing 6302	1
14	6002007	circlips 15x1 DIN471 FSt	1
15	6075396	mech shaft seal MG1/15-G64 BXPGG VP.	1
alternativ / alternative / alternative			
15	6003878	mechanical shaft seal MG1/15-G4 Q1Q1VGG	1
17	6002104	domet nut M10 DIN1587 A2	1
18	6012849	pump housing A G11/4 52.10520/1 Al	1
alternativ / alternative / alternative			
18	6012848	pump hou. AG1 1/4 GG/C0 52.19207	1

CONTRACTOR'S PUMP KE9 UNIT (6000081)

Item	Article no.	Description	Quantity
18	6024442	pump housing A G11/4 52.19189 Abrasit	1
18	6022781	pump housing A G11/4 52.19189 Abrasit/C0	1
18	6012903	pump housing AG1 1/4 1.4581 52.16782VN00	1
19	6048831	flat gasket D.125/155 ARAMID/NBR (10pc)	1
		Laufrad / Impeller / Roue 50Hz	
20	6014029	impeller-M D.130 54.3454/1 GG	1
		alternativ / alternative / alternative	
20	6014036	impeller-M D.130 54.3454/1 GG/C0	1
20	6014029	impeller-M D.130 54.3454/1 GG	1
20	6014036	impeller-M D.130 54.3454/1 GG/C0	1
		Laufrad / Impeller / Roue 60Hz	
20	6014003	impeller-M D.112 54.3013/1 AL	1
		alternativ / alternative / alternative	
20	6021762	impeller-M D.112 54.3013/1 Al/C0	1
20	6014004	impeller-M D.112 54.3013/1 GG	1
20	6021112	impeller-M D.112 54.3013/1 GG/C0	1
21	6042495	suctions strainer KE/KS9 KIT	1
21.1		> strainer KE/KS 54.18920 1.4301	1
21.2		> base plate D.160x3 1,5 1.4301	1
21.3		> screw M5x35 ISO4014 A2-70	3
22	6032617	add on strainer KS 8/9 KIT	1
23	6021392	suction plate 53.17572 GG KIT	1
23.1		> suction plate 53.17572 GG	1
23.2	6004149	> flat gasket D.50/65x2 NBR	1
23.3	6002405	> screw M5x20 DIN963 A4	3
23.4		> base plate D.160x3 1,5 1.4301	1
24	6004828	cable gland Akulon	1
25	6003824	cable peotection NBR 87x30 mm	1

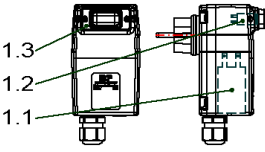
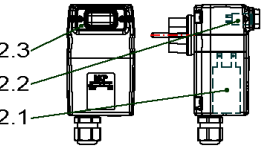
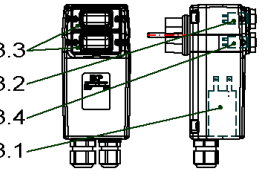
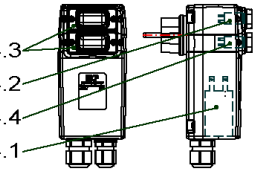
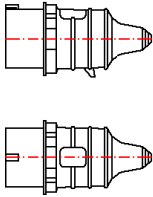
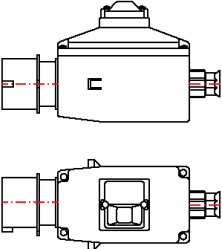
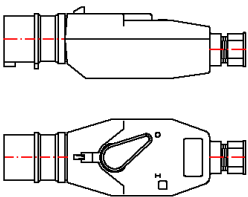
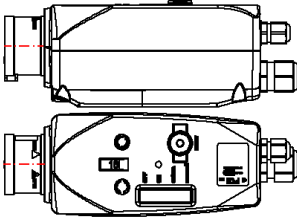
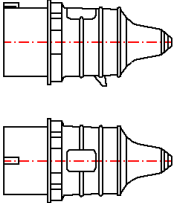
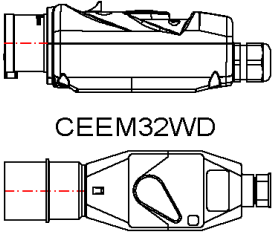
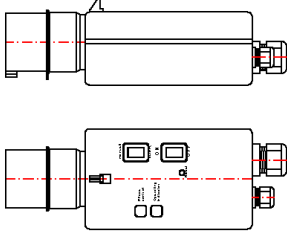
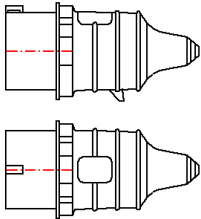
<p>1 MCP 6A-M-H-20μF ~ 230V</p>  <p>$I_N(230V / 50Hz) < 6A = 20\mu F$</p>	<p>2 MCP 10A-M-H-30μF ~ 230V</p>  <p>$I_N(230V / 50Hz) 6-10A = 30\mu F$</p>	<p>3 MCP 6A-M-HA-20μF ~ 230V</p>  <p>$I_N(230V / 50Hz) < 6A = 20\mu F$</p>	<p>4 MCP 10A-M-HA-30μF ~ 230V</p>  <p>$I_N(230V / 50Hz) 6-10A = 30\mu F$</p>
<p>5 CEE16A</p> 	<p>6 CEEM16W</p> 	<p>7 CEEM16WD</p> 	<p>8 MCP T4-HA-ROT-WSK CEE16-5PS</p> 
<p>9 CEE32A</p> 	<p>10 MCP 10-16A-T4-H-ROT CEE32-5PS</p>  <p>CEEM32WD</p>	<p>11 CEEM32WDSHA</p> 	<p>12 CEE63A</p> 

PLUG

Item	Article no.	Description	Quantity
		IN (230V / 50Hz) <6A - 20μF	
1	6072332	MCP 6A-M-H-20μF-CEE7/7 VP.	1
1.1	6071702	capacitor 400V 20μF MCP VP.	1
1.2	6071704	protection switch 6A MCP VP.	1
1.3	6071707	protecting cap MCP VP.	1
		IN (230V / 50Hz) 6-10A - 30μF	
2	6072330	MCP 10A-M-H-30μF-CEE7/7 VP.	1
2.1	6071703	capacitor 400V 30μF MCP VP.	1
2.2	6071705	protection switch 10A MCP VP.	1
2.3	6071707	protecting cap MCP VP.	1
		IN (230V / 50Hz) <6A - 20μF	
3	6072331	MCP 6A-M-HA-20μF-CEE7/7 VP.	1
3.1	6071702	capacitor 400V 20μF MCP VP.	1
3.2	6071704	protection switch 6A MCP VP.	1
3.3	6071707	protecting cap MCP VP.	2
3.4	6071706	switch on/out MCP VP.	1
		IN (230V / 50Hz) 6-10A - 30μF	
4	6072329	MCP 10A-M-HA-30μF-CEE7/7 VP	1
4.1	6071703	capacitor 400V 30μF MCP VP.	1
4.2	6071705	protection switch 10A MCP VP.	1
4.3	6071707	protecting cap MCP VP.	2
4.4	6071706	switch on/out MCP VP.	1
5	6003000	plug CEE16A/400V 60Hz/5P-11h	1
5	6003248	plug CEE16A/400V/4P-6H	1
5	6003009	plug CEE16A/400V/5P-6H	1
5	6039156	plug CEE16A/400V/5P-6H Phase inverter	1
5	6035231	plug CEE16A/400V/7P-6H	1
5	6003011	plug CEE16A/500V/5P-7H	1
6	6030883	plug MS400V5P CEE16A W 1,0-1,6A	1
6	6030884	plug MS400V5P CEE16A W 1,6-2,5A	1
6	6030888	plug MS400V5P CEE16A W 10,0-16,0A	1
6	6030885	plug MS400V5P CEE16A W 2,5-4,0A	1
6	6030886	plug MS400V5P CEE16A W 4,0-6,3A	1
6	6030887	plug MS400V5P CEE16A W 6,3-10,0A	1

PLUG

Item	Article no.	Description	Quantity
7	6032446	plug MS400V4P CEE16A WD 1,6-2,5A	1
7	6032447	plug MS400V4P CEE16A WD 12,5-16,0A	1
7	6032295	plug MS400V4P CEE16A WD 2,5-4,0A	1
7	6032289	plug MS400V4P CEE16A WD 4,0-6,3A	1
7	6032292	plug MS400V4P CEE16A WD 6,3-9,0A	1
7	6042190	plug MS400V5P CEE16A WDII 1,6-2,5A	1
7	6042194	plug MS400V5P CEE16A WDII 10,0-16,0A	1
7	6042191	plug MS400V5P CEE16A WDII 2,5-4,0A	1
7	6042192	plug MS400V5P CEE16A WDII 4,0-6,3A	1
7	6042193	plug MS400V5P CEE16A WDII 6,3-10,0A	1
7	6035911	plug MS400V5P CEE16A WD 9,0-12,5A	1
7	6003337	plug MS500V5P CEE16A WD 1,6-2,5A	1
7	6003336	plug MS500V5P CEE16A WD 2,5-4,0A	1
7	6003335	plug MS500V5P CEE16A WD 4,0-6,3A	1
7	6003334	plug MS500V5P CEE16A WD 6,3-9,0A	1
8	6072520	MCP 1,0-1,6A-T4-HA-ROT-WSK-CEE16-5PS VP.	1
8	6072521	MCP 1,6-2,4A-T4-HA-ROT-WSK-CEE16-5PS VP.	1
8	6072522	MCP 2,4-4,0A-T4-HA-ROT-WSK-CEE16-5PS VP.	1
8	6072523	MCP 4,0-6,0A-T4-HA-ROT-WSK-CEE16-5PS VP.	1
8	6072524	MCP 6,0-10A-T4-HA-ROT-WSK-CEE16-5PS VP.	1
8	6072525	MCP 9,0-12A-T4-HA-ROT-WSK-CEE16-5PS VP.	1
8	6072526	MCP 12-16A-T4-HA-ROT-WSK-CEE16-5PS VP.	1
9	6003267	plug CEE32A/400V/4P-6H	1
9	6039155	plug CEE32A/400V/5P-6H Phase inverter	1
9	6035895	plug CEE32A/500V/4P-7H AM-Top	1
9	6003010	plug CEE32A/500V/5P-7H	1
10	6072370	MCP 400V 1,6-2,5A-T4-H-ROT-CEE32-5PS VP.	1
10	6072369	MCP 400V 2,5-4,0A-T4-H-ROT-CEE32-5PS VP.	1
10	6072371	MCP 400V 4,0-6,3A-T4-H-ROT-CEE32-5PS VP.	1
10	6072398	MCP 400V 6,3-10A-T4-H-ROT-CEE32-5PS VP.	1
10	6072519	MCP 400V 10-16A-T4-H-ROT-CEE32-5PS VP.	1
10	6072399	MCP 400V 16-20A-T4-H-ROT-CEE32-5PS VP.	1
10	6072518	MCP 400V 20-25A-T4-H-ROT-CEE32-5PS VP.	1
10	6037649	plug.MS500V4P CEE32A WD 2,5-4,0A	1

PLUG

Item	Article no.	Description	Quantity
10	6041268	plug MS500V4P CEE32A WD 4,0-6,3A	1
10	6035244	plug MS500V5P CEE32A WD 1,6-2,5A	1
10	6034700	plug MS500V5P CEE32A WD 2,5-4,0A	1
10	6041556	plug MS500V5P CEE32A WD 4,0-6,3A	1
10	6002701	plug MS500V5P CEE32A WD 9,0-12,5A	1
10	6002700	plug MS500V5P CEE32A WD 12,5-16,0A	1
11	6003241	plug MS400V5P CEE32A WDSHA 10,0-14,0A	1
11	6003266	plug MS400V5P CEE32A WDSHA 3,7-5,5A	1
11	6003265	plug MS400V5P CEE32A WDSHA 5,5-8,0A	1
11	6003264	plug MS400V5P CEE32A WDSHA 8,0-11,5A	1
12	6003012	plug CEE63A/400V/5P-6H/IP67	1

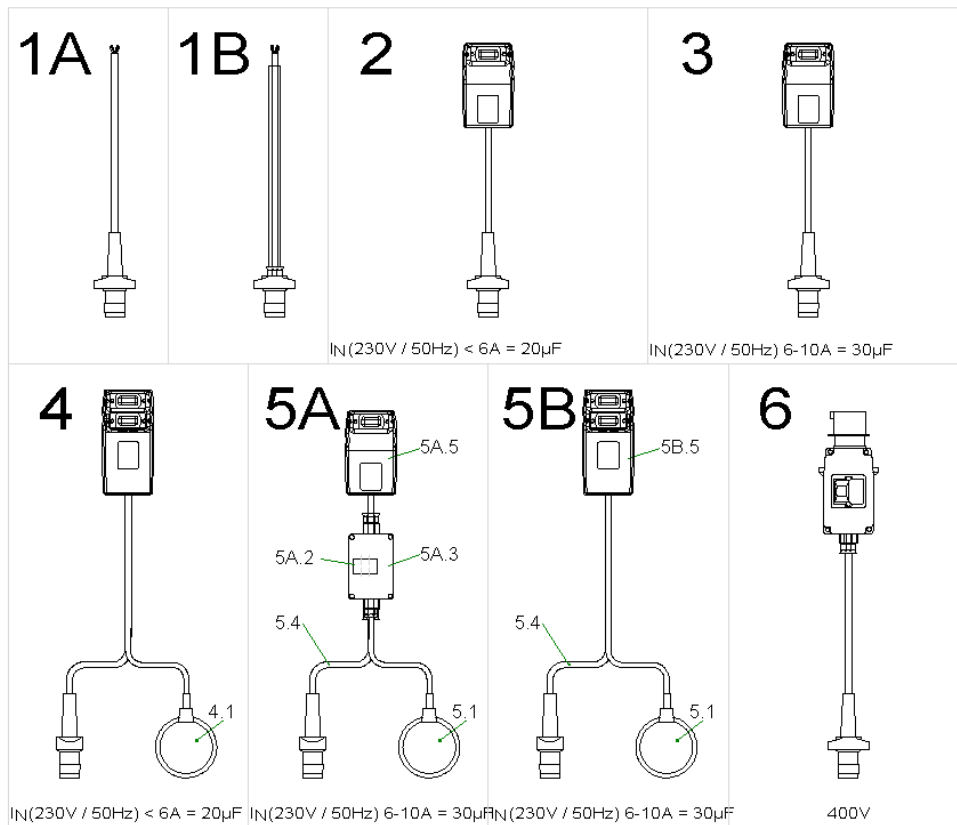

cable for motor F12 / F13

Item	Article no.	Description	Quantity
1A	6072559	cable 5m H07 4G1,5/coupling VP.	1
1A	6072560	cable 10m H07 4G1,5/coupling VP.	1
1A	6072561	cable 20m H07 4G1,5/coupling VP.	1
1A	6072562	cable 30m H07 4G1,5/coupling VP.	1
1A	6072563	cable 40m H07 4G1,5/coupling VP.	1
1A	6087533	cable 40m H07 4G1,5/coupling VP.	1
1B	6072564	cable 10m H07 4G1,5/coupl./hose VP. IN (230V / 50Hz) <6A - 20μF	1
2	6072565	switch box MCP 6A H 5M VP.	1
2	6072566	switch box MCP 6A H 10M VP.	1
2	6072567	switch box MCP 6A H 20M VP. IN (230V / 50Hz) 6-10A - 30μF	1
3	6072568	switch box MCP 10A H 5M VP.	1
3	6072569	switch box MCP 10A H 10M VP.	1
3	6072570	switch box MCP 10A H 20M VP. IN (230V / 50Hz) <6A - 20μF	1
4	6072571	switch box MCP 6A HA 5M VP.	1
4	6072572	switch box MCP 6A HA 10M VP.	1
4.1	6072582	float switch S-PS 10A 250V 10m NO VP	1
4	6072576	switch box MCP 6A HA 20M VP.	1
4.1	6072583	float switch S-PS 10A 250V 20m NO VP IN (230V / 50Hz) 6-10A - 30μF	1
5A		on request	1
5B	6072577	switch box MCP 10A HA 10M	1
5.1	6072582	float switch S-PS 10A 250V 10m NO VP	1
5A.2	6003341	contactor 5,5 kW 230 V, 50 Hz	1
5A.3	6031509	blank casing KS12/15ES KIT	1
5.4	6072560	cable 10m H07 4G1,5/coupling VP.	1
5A.5	6072330	MCP 10A-M-H-30μF-CEE7/7 VP.	1
5B.5	6072329	MCP 10A-M-HA-30μF-CEE7/7 VP für / for / pour 400V	1
6	6023991	switch box CEEM16W 2,5A, 10m SVA	1
6	6001253	switch box CEEM16W 4A, 10m SVA	1
6	6023992	switch box CEEM16W 6,3A, 20m SVA	1

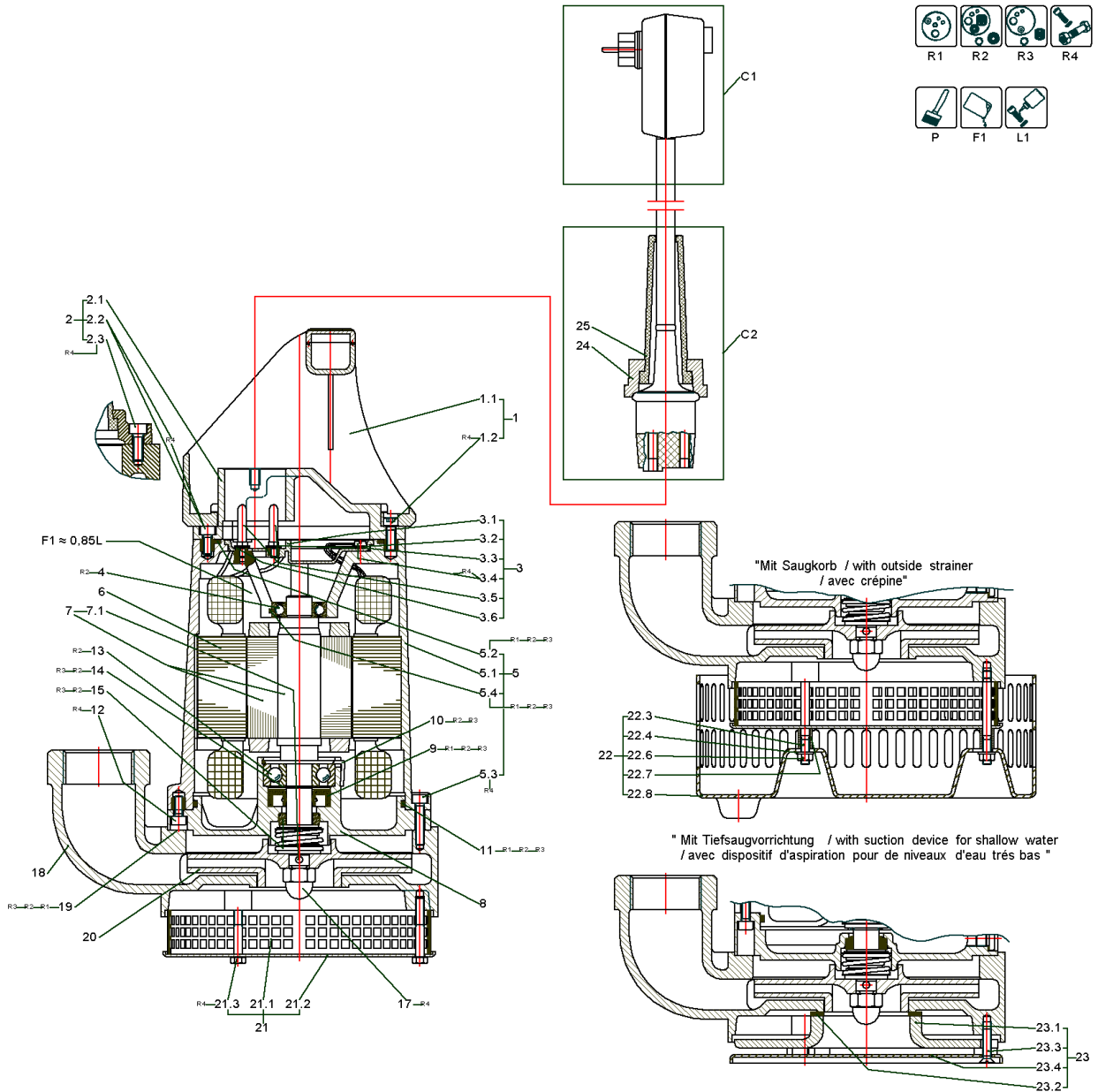

CONTRACTOR'S PUMP KE9GG UNIT (6000082)

Item	Article no.	Description	Quantity
R1	6016271	Rep.Kit 1 KE7,8,9 Vit	1
R2	6016283	Rep.Kit 2 KE7,8,9 Vit	1
R3	6016296	Rep.Kit 3 KE7,8,9 Vit	1
R4	6016132	Screws KS8,9,12,14,15 KE7;8;9, F12 KIT	1
P	6042254	PAINT SPRAY Pantone334	1
P	6042255	colour 2K-paint IV80 pantone334C 250ml	1
P	6023614	Ceram C0 black 100 ml KIT	1
P	6020579	Ceram C0 black 250 ml KIT	1
P	6023485	Ceram C0 Black 500ml Kit	1
P	6019157	Ceram C0 black 1000 ml KIT	1
F1	6025460	medical white oil 1L KIT	1
L1	6080531	Loctite 243 5g flask VP:	1
L1	2096167	Loctite 243 50ml VP.	1

C1		PLUG	1
C2		cable for motor F12 / F13	1

1	6019566	handle 51.15480/1 plastics KIT	1
1.2		> screw M5x16 ISO4762 A2-70	1
1.1		> handle 51.15480/1 Akulon	1
2	6022949	motor cover D.95,8 51.17219 GG KIT	1
2.1		> motor cover D.95,8 51.17219 GG	1
2.2		> SCREW M5X12 ISO4762 A2-70	3
2.3		> screw M6x16 DIN912 A4 (10pc)	1
3	6001273	terminal board 54.3453 Makrolon KIT	1
3.1		> terminal board plastics Polycarbonat	1
3.5		> contact pin Ms	4
3.2		> lock washer 4 DIN7980 A4	1
3.3		> washer A4,3 DIN125 Ms	5
3.4		> screw M4x8 DIN84 Ms	1
3.6		> washer 4,3 DIN7349 Ms	1
4	6086141	ball bearing 6002 VP.	1
5	6022378	motor casing 52.2924/1E GG KIT	1
5.1		> motor casing 52.2924/1 GG	1

CONTRACTOR'S PUMP KE9GG UNIT (6000082)

Item	Article no.	Description	Quantity
5.2		> o-ring ID.92,0x3,0 Viton	1
5.3		> screw M5x25 DIN912 A2-70	3
5.3		> screw M5x45 ISO4762 A2-70	3
Note: für / for / pour KS			
5.4		> o-ring ID.32x1,78 Viton	1
		Stator / stator / stator 50 Hz	
6	6023535	stator F12-2/6 230E 50Hz Ser11	1
6	6023532	stator F12-2/6 400 50Hz VN 01	1
6	6023533	stator F12-2/6 415 50Hz VN 01	1
6	6023534	stator F12-2/6 500 50Hz VN 01	1
		alternativ / alternative / alternative	
6	6023531	stator F12-2/6 230 50Hz	1
		Stator / stator / stator 60 Hz	
6	6023536	stator F12-2/6 230E 60Hz Ser11	1
6	6023537	stator F12-2/6 230/400 60Hz	1
7	6010022	rotor D.61,4x169 2/6 1.4021	1
7.1	6002743	slotted pin 4x6 DIN1473 1.4305	1
8	6017894	bearing end plate 53.3450/1 GG	1
9	6007489	shaft seal ring A15/37x10 DIN3760 NBR+A2	1
		alternativ / alternative / alternative	
9	6019482	shaft seal ring A15x37x10 DIN3760 NBR LA	1
10	6004669	circlips 43,6x1,8 54.3438 FSt	1
11		o-ring ID.115,0x3,0 Viton -	1
12		SCREW M5X12 ISO4762 A2-70	3
13	6008975	ball bearing 6302	1
14	6002007	circlips 15x1 DIN471 FSt	1
15	6075396	mech shaft seal MG1/15-G64 BXPGG VP.	1
		alternativ / alternative / alternative	
15	6003878	mechanical shaft seal MG1/15-G4 Q1Q1VGG	1
17	6002104	domet nut M10 DIN1587 A2	1
18	6012850	pump housing A G11/4 52.10520/2 GG	1
		alternativ / alternative / alternative	
18	6012848	pump hou. AG1 1/4 GG/C0 52.19207	1
18	6024442	pump housing A G11/4 52.19189 Abrasit	1

CONTRACTOR'S PUMP KE9GG UNIT (6000082)

Item	Article no.	Description	Quantity
18	6022781	pump housing A G11/4 52.19189 Abrasit/C0	1
18	6012903	pump housing AG1 1/4 1.4581 52.16782VN00	1
19	6048831	flat gasket D.125/155 ARAMID/NBR (10pc)	1
		Laufrad / Impeller / Roue 50Hz	
20	6014029	impeller-M D.130 54.3454/1 GG	1
		alternativ / alternative / alternative	
20	6014036	impeller-M D.130 54.3454/1 GG/C0	1
		Laufrad / Impeller / Roue 60Hz	
20	6014004	impeller-M D.112 54.3013/1 GG	1
		alternativ / alternative / alternative	
20	6021112	impeller-M D.112 54.3013/1 GG/C0	1
21	6042495	suctions strainer KE/KS9 KIT	1
21.1		> strainer KE/KS 54.18920 1.4301	1
21.2		> base plate D.160x3 1,5 1.4301	1
21.3		> screw M5x35 ISO4014 A2-70	3
22	6032617	add on strainer KS 8/9 KIT	1
23	6021392	suction plate 53.17572 GG KIT	1
23.1		> suction plate 53.17572 GG	1
23.2	6004149	> flat gasket D.50/65x2 NBR	1
23.3	6002405	> screw M5x20 DIN963 A4	3
23.4		> base plate D.160x3 1,5 1.4301	1
24	6004828	cable gland Akulon	1
25	6003824	cable peotection NBR 87x30 mm	1

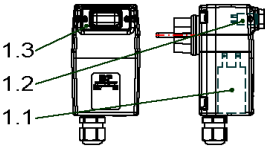
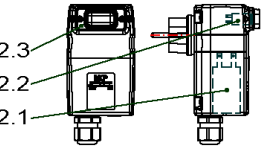
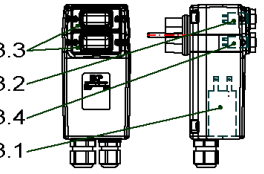
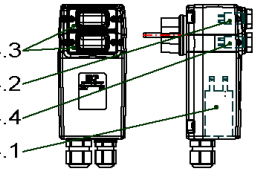
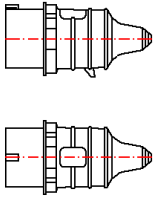
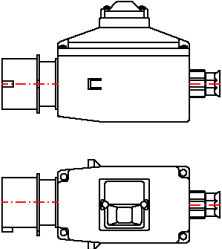
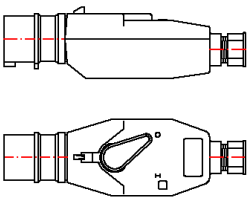
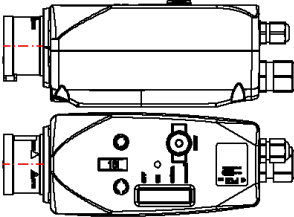
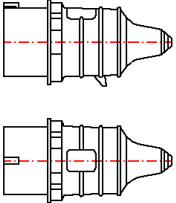
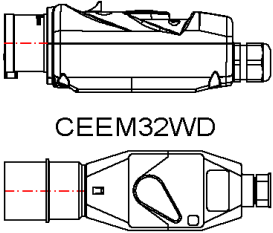
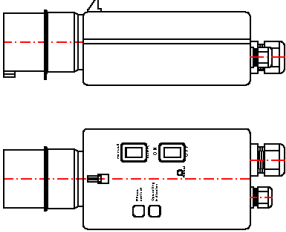
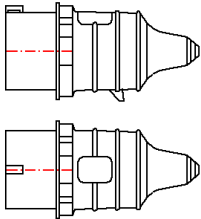
<p>1 MCP 6A-M-H-20μF ~ 230V</p>  <p>$I_N(230V / 50Hz) < 6A = 20\mu F$</p>	<p>2 MCP 10A-M-H-30μF ~ 230V</p>  <p>$I_N(230V / 50Hz) 6-10A = 30\mu F$</p>	<p>3 MCP 6A-M-HA-20μF ~ 230V</p>  <p>$I_N(230V / 50Hz) < 6A = 20\mu F$</p>	<p>4 MCP 10A-M-HA-30μF ~ 230V</p>  <p>$I_N(230V / 50Hz) 6-10A = 30\mu F$</p>
<p>5 CEE16A</p> 	<p>6 CEEM16W</p> 	<p>7 CEEM16WD</p> 	<p>8 MCP T4-HA-ROT-WSK CEE16-5PS</p> 
<p>9 CEE32A</p> 	<p>10 MCP 10-16A-T4-H-ROT CEE32-5PS</p>  <p>CEEM32WD</p>	<p>11 CEEM32WDSHA</p> 	<p>12 CEE63A</p> 

PLUG

Item	Article no.	Description	Quantity
		IN (230V / 50Hz) <6A - 20µF	
1	6072332	MCP 6A-M-H-20µF-CEE7/7 VP.	1
1.1	6071702	capacitor 400V 20µF MCP VP.	1
1.2	6071704	protection switch 6A MCP VP.	1
1.3	6071707	protecting cap MCP VP.	1
		IN (230V / 50Hz) 6-10A - 30µF	
2	6072330	MCP 10A-M-H-30µF-CEE7/7 VP.	1
2.1	6071703	capacitor 400V 30µF MCP VP.	1
2.2	6071705	protection switch 10A MCP VP.	1
2.3	6071707	protecting cap MCP VP.	1
		IN (230V / 50Hz) <6A - 20µF	
3	6072331	MCP 6A-M-HA-20µF-CEE7/7 VP.	1
3.1	6071702	capacitor 400V 20µF MCP VP.	1
3.2	6071704	protection switch 6A MCP VP.	1
3.3	6071707	protecting cap MCP VP.	2
3.4	6071706	switch on/out MCP VP.	1
		IN (230V / 50Hz) 6-10A - 30µF	
4	6072329	MCP 10A-M-HA-30µF-CEE7/7 VP	1
4.1	6071703	capacitor 400V 30µF MCP VP.	1
4.2	6071705	protection switch 10A MCP VP.	1
4.3	6071707	protecting cap MCP VP.	2
4.4	6071706	switch on/out MCP VP.	1
5	6003000	plug CEE16A/400V 60Hz/5P-11h	1
5	6003248	plug CEE16A/400V/4P-6H	1
5	6003009	plug CEE16A/400V/5P-6H	1
5	6039156	plug CEE16A/400V/5P-6H Phase inverter	1
5	6035231	plug CEE16A/400V/7P-6H	1
5	6003011	plug CEE16A/500V/5P-7H	1
6	6030883	plug MS400V5P CEE16A W 1,0-1,6A	1
6	6030884	plug MS400V5P CEE16A W 1,6-2,5A	1
6	6030888	plug MS400V5P CEE16A W 10,0-16,0A	1
6	6030885	plug MS400V5P CEE16A W 2,5-4,0A	1
6	6030886	plug MS400V5P CEE16A W 4,0-6,3A	1
6	6030887	plug MS400V5P CEE16A W 6,3-10,0A	1

PLUG

Item	Article no.	Description	Quantity
7	6032446	plug MS400V4P CEE16A WD 1,6-2,5A	1
7	6032447	plug MS400V4P CEE16A WD 12,5-16,0A	1
7	6032295	plug MS400V4P CEE16A WD 2,5-4,0A	1
7	6032289	plug MS400V4P CEE16A WD 4,0-6,3A	1
7	6032292	plug MS400V4P CEE16A WD 6,3-9,0A	1
7	6042190	plug MS400V5P CEE16A WDII 1,6-2,5A	1
7	6042194	plug MS400V5P CEE16A WDII 10,0-16,0A	1
7	6042191	plug MS400V5P CEE16A WDII 2,5-4,0A	1
7	6042192	plug MS400V5P CEE16A WDII 4,0-6,3A	1
7	6042193	plug MS400V5P CEE16A WDII 6,3-10,0A	1
7	6035911	plug MS400V5P CEE16A WD 9,0-12,5A	1
7	6003337	plug MS500V5P CEE16A WD 1,6-2,5A	1
7	6003336	plug MS500V5P CEE16A WD 2,5-4,0A	1
7	6003335	plug MS500V5P CEE16A WD 4,0-6,3A	1
7	6003334	plug MS500V5P CEE16A WD 6,3-9,0A	1
8	6072520	MCP 1,0-1,6A-T4-HA-ROT-WSK-CEE16-5PS VP.	1
8	6072521	MCP 1,6-2,4A-T4-HA-ROT-WSK-CEE16-5PS VP.	1
8	6072522	MCP 2,4-4,0A-T4-HA-ROT-WSK-CEE16-5PS VP.	1
8	6072523	MCP 4,0-6,0A-T4-HA-ROT-WSK-CEE16-5PS VP.	1
8	6072524	MCP 6,0-10A-T4-HA-ROT-WSK-CEE16-5PS VP.	1
8	6072525	MCP 9,0-12A-T4-HA-ROT-WSK-CEE16-5PS VP.	1
8	6072526	MCP 12-16A-T4-HA-ROT-WSK-CEE16-5PS VP.	1
9	6003267	plug CEE32A/400V/4P-6H	1
9	6039155	plug CEE32A/400V/5P-6H Phase inverter	1
9	6035895	plug CEE32A/500V/4P-7H AM-Top	1
9	6003010	plug CEE32A/500V/5P-7H	1
10	6072370	MCP 400V 1,6-2,5A-T4-H-ROT-CEE32-5PS VP.	1
10	6072369	MCP 400V 2,5-4,0A-T4-H-ROT-CEE32-5PS VP.	1
10	6072371	MCP 400V 4,0-6,3A-T4-H-ROT-CEE32-5PS VP.	1
10	6072398	MCP 400V 6,3-10A-T4-H-ROT-CEE32-5PS VP.	1
10	6072519	MCP 400V 10-16A-T4-H-ROT-CEE32-5PS VP.	1
10	6072399	MCP 400V 16-20A-T4-H-ROT-CEE32-5PS VP.	1
10	6072518	MCP 400V 20-25A-T4-H-ROT-CEE32-5PS VP.	1
10	6037649	plug.MS500V4P CEE32A WD 2,5-4,0A	1

PLUG

Item	Article no.	Description	Quantity
10	6041268	plug MS500V4P CEE32A WD 4,0-6,3A	1
10	6035244	plug MS500V5P CEE32A WD 1,6-2,5A	1
10	6034700	plug MS500V5P CEE32A WD 2,5-4,0A	1
10	6041556	plug MS500V5P CEE32A WD 4,0-6,3A	1
10	6002701	plug MS500V5P CEE32A WD 9,0-12,5A	1
10	6002700	plug MS500V5P CEE32A WD 12,5-16,0A	1
11	6003241	plug MS400V5P CEE32A WDSHA 10,0-14,0A	1
11	6003266	plug MS400V5P CEE32A WDSHA 3,7-5,5A	1
11	6003265	plug MS400V5P CEE32A WDSHA 5,5-8,0A	1
11	6003264	plug MS400V5P CEE32A WDSHA 8,0-11,5A	1
12	6003012	plug CEE63A/400V/5P-6H/IP67	1

cable for motor F12 / F13

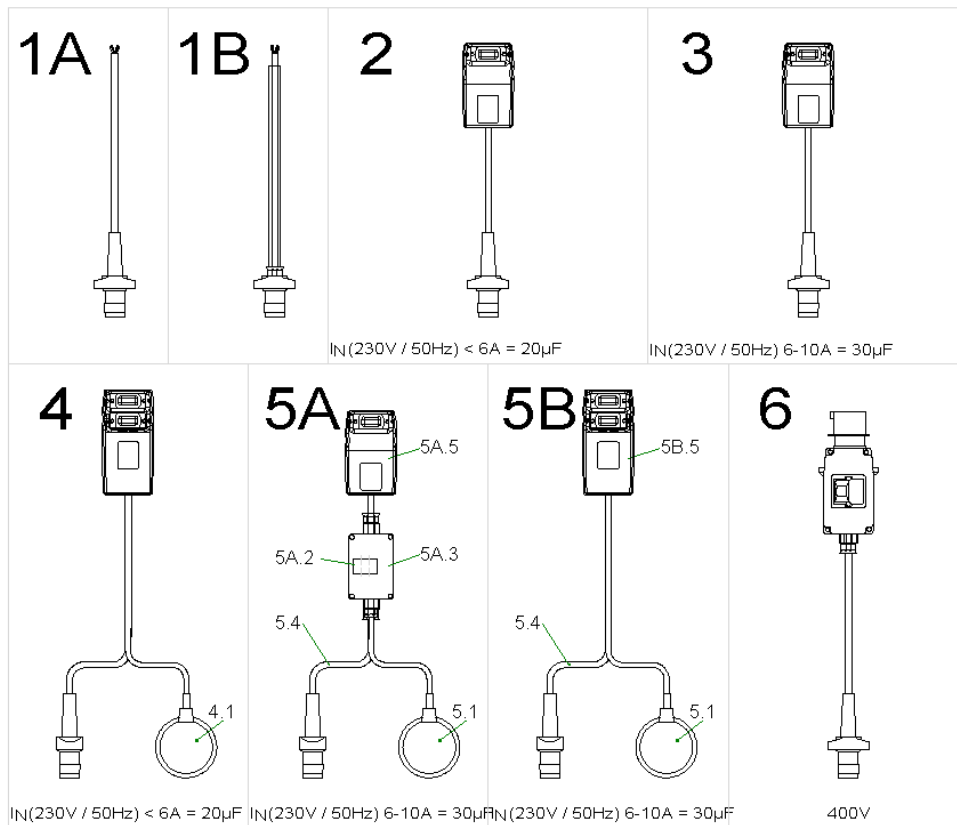

cable for motor F12 / F13

Item	Article no.	Description	Quantity
1A	6072559	cable 5m H07 4G1,5/coupling VP.	1
1A	6072560	cable 10m H07 4G1,5/coupling VP.	1
1A	6072561	cable 20m H07 4G1,5/coupling VP.	1
1A	6072562	cable 30m H07 4G1,5/coupling VP.	1
1A	6072563	cable 40m H07 4G1,5/coupling VP.	1
1A	6087533	cable 40m H07 4G1,5/coupling VP.	1
1B	6072564	cable 10m H07 4G1,5/coupl./hose VP. IN (230V / 50Hz) <6A - 20µF	1
2	6072565	switch box MCP 6A H 5M VP.	1
2	6072566	switch box MCP 6A H 10M VP.	1
2	6072567	switch box MCP 6A H 20M VP. IN (230V / 50Hz) 6-10A - 30µF	1
3	6072568	switch box MCP 10A H 5M VP.	1
3	6072569	switch box MCP 10A H 10M VP.	1
3	6072570	switch box MCP 10A H 20M VP. IN (230V / 50Hz) <6A - 20µF	1
4	6072571	switch box MCP 6A HA 5M VP.	1
4	6072572	switch box MCP 6A HA 10M VP.	1
4.1	6072582	float switch S-PS 10A 250V 10m NO VP	1
4	6072576	switch box MCP 6A HA 20M VP.	1
4.1	6072583	float switch S-PS 10A 250V 20m NO VP IN (230V / 50Hz) 6-10A - 30µF	1
5A		on request	1
5B	6072577	switch box MCP 10A HA 10M	1
5.1	6072582	float switch S-PS 10A 250V 10m NO VP	1
5A.2	6003341	contactor 5,5 kW 230 V, 50 Hz	1
5A.3	6031509	blank casing KS12/15ES KIT	1
5.4	6072560	cable 10m H07 4G1,5/coupling VP.	1
5A.5	6072330	MCP 10A-M-H-30µF-CEE7/7 VP.	1
5B.5	6072329	MCP 10A-M-HA-30µF-CEE7/7 VP für / for / pour 400V	1
6	6023991	switch box CEEM16W 2,5A, 10m SVA	1
6	6001253	switch box CEEM16W 4A, 10m SVA	1
6	6023992	switch box CEEM16W 6,3A, 20m SVA	1

KS5

Bm3

S/N < 650056989

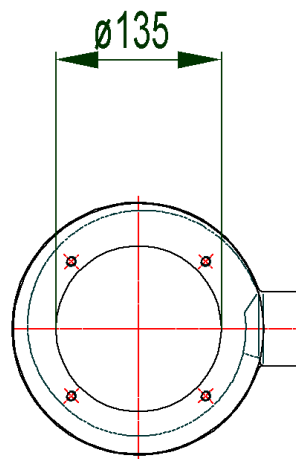
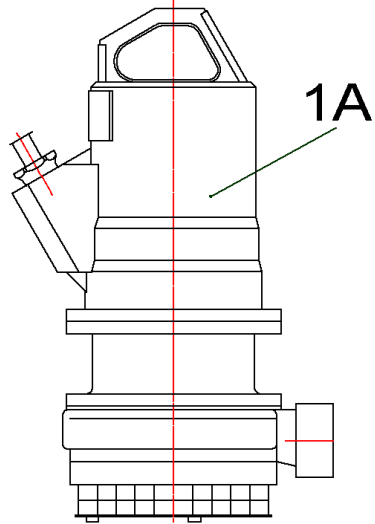

Bm4

S/N > 650056990

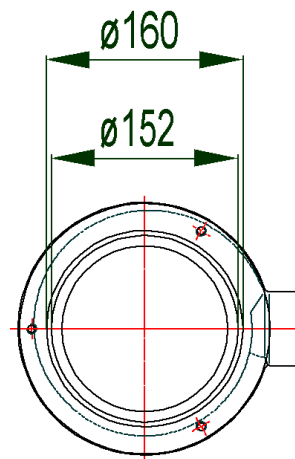
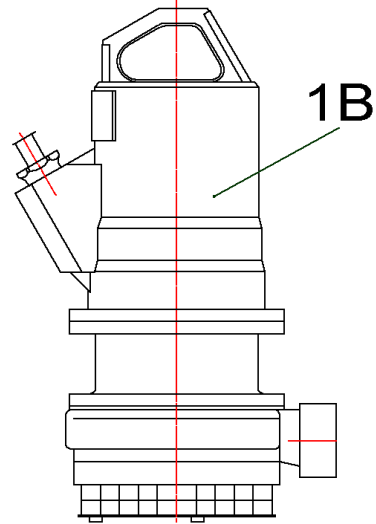

CONTRACTOR'S PUMP KS5 UNIT (6000104)

Item	Description	Quantity
1A	CONTRACTOR'S PUMP KS5 (Bm3) UNIT	1
1B	CONTRACTOR'S PUMP KS5 (Bm4) UNIT	1

CONTRACTOR'S PUMP KS5 (Bm3) UNIT

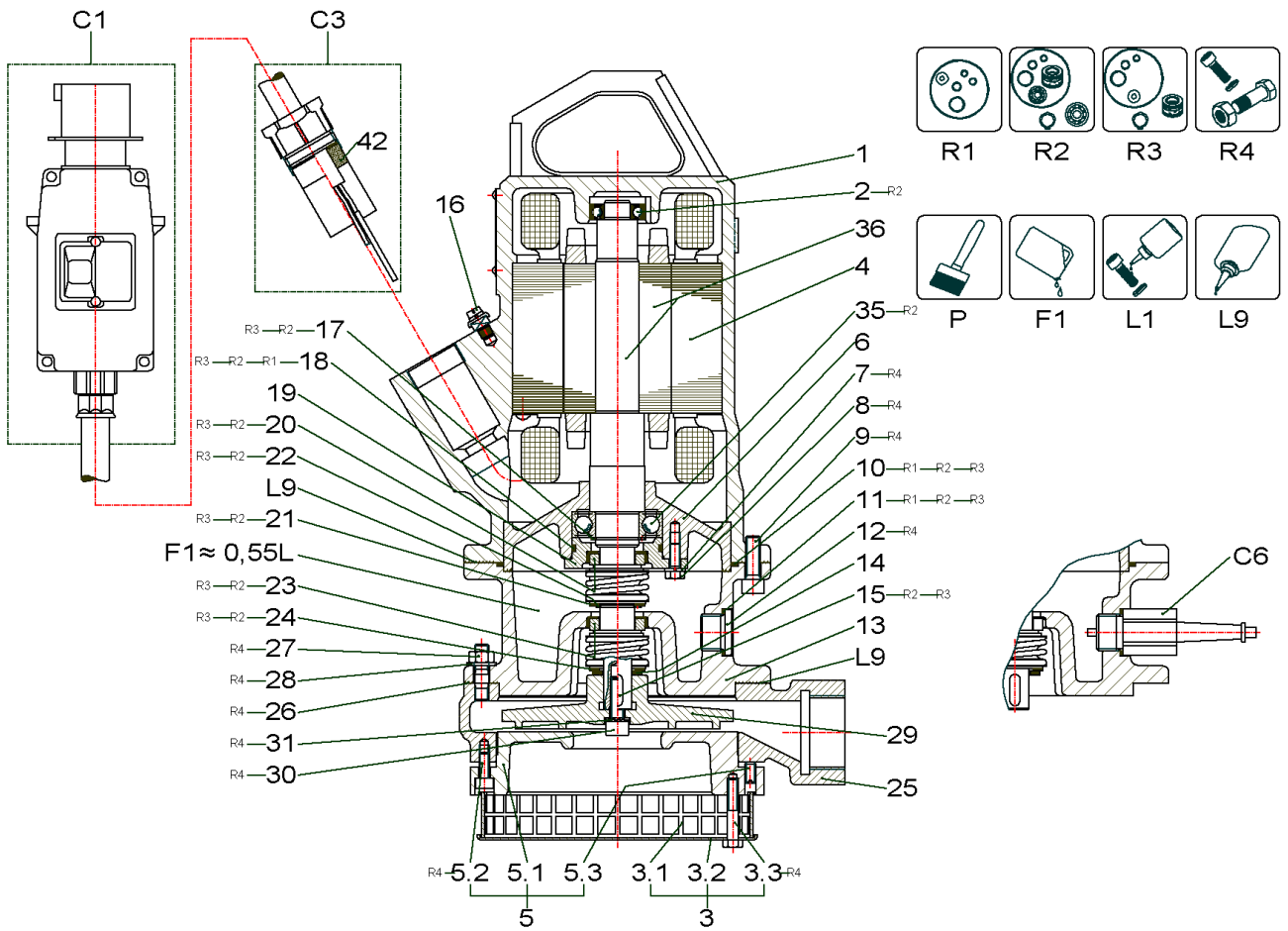

CONTRACTOR'S PUMP KS5 (Bm3) UNIT

Item	Article no.	Description	Quantity
R1	6016204	Rep.Kit 1 T12K, T12G BM2 / BM3 Vit	1
R2	6016074	Rep.Kit 2 T12K;T12G Bm2/Bm3 Vit	1
R3	6016073	Rep.Kit 3 T12K;T12G Bm2/Bm3 Vit	1
R4	6042219	Screws KS5,6,16/T12 KIT	1
P	6042254	PAINT SPRAY Pantone334	1
P	6042255	colour 2K-paint IV80 pantone334C 250ml	1
P	6023614	Ceram C0 black 100 ml KIT	1
P	6020579	Ceram C0 black 250 ml KIT	1
P	6023485	Ceram C0 Black 500ml Kit	1
P	6019157	Ceram C0 black 1000 ml KIT	1
F1	6025460	medical white oil 1L KIT	1
L1	6080531	Loctite 243 5g flask VP:	1
L1	2096167	Loctite 243 50ml VP.	1
L9	6080535	Loctite 5203 300ml VP.	1

C1		PLUG	1
C3		cable trumpet 30T KIT	1
C6		electrode KIT	1

1	6013993	motor casing 50.18026/1 GG	1
2	6086141	ball bearing 6002 VP.	1
36	6010586	rotor D.61,4x265 2/6 1.4021	1
4	6023501	stator T12-2/6 400 50Hz VN01	1
		alternativ / alternative / alternative	
4	6023502	stator T12-2/6 500 50Hz VN01	1
35	2046946	ball bearing 6205/2RS-C3 (HT) VP.	1
6	6085141	bearing housing 53.17238 GG VP.	1
7		lock washer 6 DIN7980 A4	3
8		screw M6x16 DIN933 A2-70 (10pc)	1
9		screw M8x25 DIN912 A4 (10pc)	1
10		o-ring ID.125,0x3,0 Viton	1
11	6048832	joint ring A21/26x1,5 DIN7603 PA(10pc)	1
12	6067638	screw plug G1/2 DIN908 A4 (3pcs)	1
13	6013686	sealing casing D.135g6 52.17240 GG	1

CONTRACTOR'S PUMP KS5 (Bm3) UNIT

Item	Article no.	Description	Quantity
		alternativ / alternative / alternative	
13	6013684	sealing casing D.135g6 52.17240 GG/C0	1
13	6013685	sealing casing D.135g6 52.17240 GG/C1	1
14	6002118	washer 17 DIN433 A2	1
15	6004654	key A 6x4x18 54.2589 A4	1
16	6067407	Barlian bow terminal M5 A2	1
17	6002002	circlips 25x1,2 DIN471 FSt	1
18		-ring ID.44,0x3,0 Viton 75	1
19	6085142	bearing cover D.35H7 53.17239 GG VP.	1
20	6074596	mechanical shaft seal MG1/20-G64 Q1Q1VGG	1
21	6005374	pressure ring 31,6x1 1.4571	1
22	6002006	circlips 20x1,2 DIN471 1.4116	1
23	6074596	mechanical shaft seal MG1/20-G64 Q1Q1VGG	1
24	6005374	pressure ring 31,6x1 1.4571	1
25	6012676	pump housing QG1 1/4 52.18392 GG	1
		alternativ / alternative / alternative	
25	6012675	pump housing QG1 1/4 52.18392 GG/C0	1
26		screw M8x22 DIN939 A2-70	4
27		nut M8 DIN934 A2-80	4
28		washer A8,4 DIN125 1.4401 (20pc)	1
29	6014148	impeller-W D.113 54.18382 GG	1
		alternativ / alternative / alternative	
29	6014147	impeller-W D.113 54.18382 GG/C0	1
30	6003416	screw M8x25 DIN912 10.9 Geomet	1
31	6002688	screw locking Nord-Lock 13,5/8,7 A4	1
5	6072179	suction port KS5/6 M03-12 53.14379 GG KI	1
5.1		> suction port 53.14379 GG	1
5.2		> screw M6x16 ISO4762 A4	3
5.3		> Stud bolt M8x12 DIN915 A4	3
		alternativ / alternative / alternative	
5.1	6012770	suction port 53.14379 GG/C0	1
3	6072178	strainer KS5/6 M03-12 1.4301 KIT	1
3.1		> strainer 26x155x2 1.4301	1
3.2		> base plate D.160x3 1,5 1.4301	1

CONTRACTOR'S PUMP KS5 (Bm3) UNIT

Item	Article no.	Description	Quantity
3.3		> screw M6x35 ISO4014 A4-70	3
		alternativ / alternative / alternative	
3.1	6013182	strainer 26x155x2 54.10534/1 1.4301 C0	1
3.2	6017621	base plate D.160x3 53.10536/1 1.4301/C0	1
42	6076649	seal ring D.29,5/16x16,5 54.17777NBR VP.	1
42	6076650	seal ring D.29,5/17x16,5 54.17777 NBR VP	1
42	6076651	seal ring D.29,5/19x16,5 54.17777NBR VP.	1
		alternativ / alternative / alternative	
42	6037031	seal ring D.29,5/16x16,5 CR silicon free	1
42	6037478	seal ring D.29,5/19x16,5 CR silicon free	1

<p>1 MCP 6A-M-H-20μF ~ 230V</p> <p>$I_N(230V / 50Hz) < 6A = 20\mu F$</p>	<p>2 MCP 10A-M-H-30μF ~ 230V</p> <p>$I_N(230V / 50Hz) 6-10A = 30\mu F$</p>	<p>3 MCP 6A-M-HA-20μF ~ 230V</p> <p>$I_N(230V / 50Hz) < 6A = 20\mu F$</p>	<p>4 MCP 10A-M-HA-30μF ~ 230V</p> <p>$I_N(230V / 50Hz) 6-10A = 30\mu F$</p>
<p>5 CEE16A</p>	<p>6 CEEM16W</p>	<p>7 CEEM16WD</p>	<p>8 MCP T4-HA-ROT-WSK CEE16-5PS</p>
<p>9 CEE32A</p>	<p>10 MCP 10-16A-T4-H-ROT CEE32-5PS</p> <p>CEEM32WD</p>	<p>11 CEEM32WDSHA</p>	<p>12 CEE63A</p>

PLUG

Item	Article no.	Description	Quantity
		IN (230V / 50Hz) <6A - 20μF	
1	6072332	MCP 6A-M-H-20μF-CEE7/7 VP.	1
1.1	6071702	capacitor 400V 20μF MCP VP.	1
1.2	6071704	protection switch 6A MCP VP.	1
1.3	6071707	protecting cap MCP VP.	1
		IN (230V / 50Hz) 6-10A - 30μF	
2	6072330	MCP 10A-M-H-30μF-CEE7/7 VP.	1
2.1	6071703	capacitor 400V 30μF MCP VP.	1
2.2	6071705	protection switch 10A MCP VP.	1
2.3	6071707	protecting cap MCP VP.	1
		IN (230V / 50Hz) <6A - 20μF	
3	6072331	MCP 6A-M-HA-20μF-CEE7/7 VP.	1
3.1	6071702	capacitor 400V 20μF MCP VP.	1
3.2	6071704	protection switch 6A MCP VP.	1
3.3	6071707	protecting cap MCP VP.	2
3.4	6071706	switch on/out MCP VP.	1
		IN (230V / 50Hz) 6-10A - 30μF	
4	6072329	MCP 10A-M-HA-30μF-CEE7/7 VP	1
4.1	6071703	capacitor 400V 30μF MCP VP.	1
4.2	6071705	protection switch 10A MCP VP.	1
4.3	6071707	protecting cap MCP VP.	2
4.4	6071706	switch on/out MCP VP.	1
5	6003000	plug CEE16A/400V 60Hz/5P-11h	1
5	6003248	plug CEE16A/400V/4P-6H	1
5	6003009	plug CEE16A/400V/5P-6H	1
5	6039156	plug CEE16A/400V/5P-6H Phase inverter	1
5	6035231	plug CEE16A/400V/7P-6H	1
5	6003011	plug CEE16A/500V/5P-7H	1
6	6030883	plug MS400V5P CEE16A W 1,0-1,6A	1
6	6030884	plug MS400V5P CEE16A W 1,6-2,5A	1
6	6030888	plug MS400V5P CEE16A W 10,0-16,0A	1
6	6030885	plug MS400V5P CEE16A W 2,5-4,0A	1
6	6030886	plug MS400V5P CEE16A W 4,0-6,3A	1
6	6030887	plug MS400V5P CEE16A W 6,3-10,0A	1

PLUG

Item	Article no.	Description	Quantity
7	6032446	plug MS400V4P CEE16A WD 1,6-2,5A	1
7	6032447	plug MS400V4P CEE16A WD 12,5-16,0A	1
7	6032295	plug MS400V4P CEE16A WD 2,5-4,0A	1
7	6032289	plug MS400V4P CEE16A WD 4,0-6,3A	1
7	6032292	plug MS400V4P CEE16A WD 6,3-9,0A	1
7	6042190	plug MS400V5P CEE16A WDII 1,6-2,5A	1
7	6042194	plug MS400V5P CEE16A WDII 10,0-16,0A	1
7	6042191	plug MS400V5P CEE16A WDII 2,5-4,0A	1
7	6042192	plug MS400V5P CEE16A WDII 4,0-6,3A	1
7	6042193	plug MS400V5P CEE16A WDII 6,3-10,0A	1
7	6035911	plug MS400V5P CEE16A WD 9,0-12,5A	1
7	6003337	plug MS500V5P CEE16A WD 1,6-2,5A	1
7	6003336	plug MS500V5P CEE16A WD 2,5-4,0A	1
7	6003335	plug MS500V5P CEE16A WD 4,0-6,3A	1
7	6003334	plug MS500V5P CEE16A WD 6,3-9,0A	1
8	6072520	MCP 1,0-1,6A-T4-HA-ROT-WSK-CEE16-5PS VP.	1
8	6072521	MCP 1,6-2,4A-T4-HA-ROT-WSK-CEE16-5PS VP.	1
8	6072522	MCP 2,4-4,0A-T4-HA-ROT-WSK-CEE16-5PS VP.	1
8	6072523	MCP 4,0-6,0A-T4-HA-ROT-WSK-CEE16-5PS VP.	1
8	6072524	MCP 6,0-10A-T4-HA-ROT-WSK-CEE16-5PS VP.	1
8	6072525	MCP 9,0-12A-T4-HA-ROT-WSK-CEE16-5PS VP.	1
8	6072526	MCP 12-16A-T4-HA-ROT-WSK-CEE16-5PS VP.	1
9	6003267	plug CEE32A/400V/4P-6H	1
9	6039155	plug CEE32A/400V/5P-6H Phase inverter	1
9	6035895	plug CEE32A/500V/4P-7H AM-Top	1
9	6003010	plug CEE32A/500V/5P-7H	1
10	6072370	MCP 400V 1,6-2,5A-T4-H-ROT-CEE32-5PS VP.	1
10	6072369	MCP 400V 2,5-4,0A-T4-H-ROT-CEE32-5PS VP.	1
10	6072371	MCP 400V 4,0-6,3A-T4-H-ROT-CEE32-5PS VP.	1
10	6072398	MCP 400V 6,3-10A-T4-H-ROT-CEE32-5PS VP.	1
10	6072519	MCP 400V 10-16A-T4-H-ROT-CEE32-5PS VP.	1
10	6072399	MCP 400V 16-20A-T4-H-ROT-CEE32-5PS VP.	1
10	6072518	MCP 400V 20-25A-T4-H-ROT-CEE32-5PS VP.	1
10	6037649	plug.MS500V4P CEE32A WD 2,5-4,0A	1

PLUG

Item	Article no.	Description	Quantity
10	6041268	plug MS500V4P CEE32A WD 4,0-6,3A	1
10	6035244	plug MS500V5P CEE32A WD 1,6-2,5A	1
10	6034700	plug MS500V5P CEE32A WD 2,5-4,0A	1
10	6041556	plug MS500V5P CEE32A WD 4,0-6,3A	1
10	6002701	plug MS500V5P CEE32A WD 9,0-12,5A	1
10	6002700	plug MS500V5P CEE32A WD 12,5-16,0A	1
11	6003241	plug MS400V5P CEE32A WDSHA 10,0-14,0A	1
11	6003266	plug MS400V5P CEE32A WDSHA 3,7-5,5A	1
11	6003265	plug MS400V5P CEE32A WDSHA 5,5-8,0A	1
11	6003264	plug MS400V5P CEE32A WDSHA 8,0-11,5A	1
12	6003012	plug CEE63A/400V/5P-6H/IP67	1

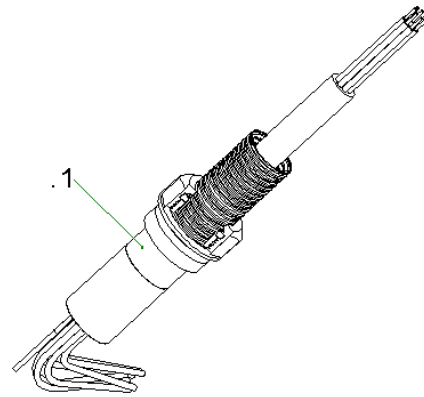
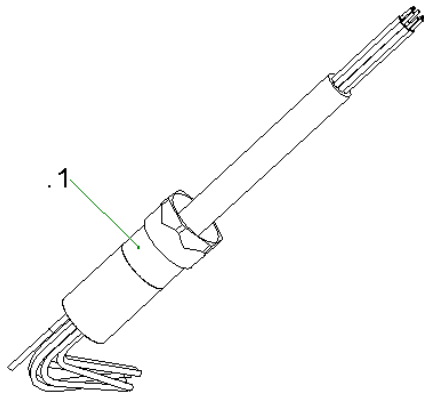

- 1 H07RN-F
- 2 NSSHOEU-J
- 3 SOOW

- 4 H07RN-F
- 5 NSSHOEU-J

cable trumpet 30T KIT

Item	Article no.	Description	Quantity
.1	6076649	seal ring D.29,5/16x16,5 54.17777NBR VP.	1
.1	6076651	seal ring D.29,5/19x16,5 54.17777NBR VP.	1
.1	6076650	seal ring D.29,5/17x16,5 54.17777 NBR VP alternativ / alternative / alternative	1
.1	6037031	seal ring D.29,5/16x16,5 CR silicon free	1
.1	6037478	seal ring D.29,5/19x16,5 CR silicon free	1
1	6022379	cable trumpet 30T 5m H07 7G1,5 KIT	1
1	6019236	cable trumpet 30T 10m H07 7G1,5 KIT	1
1	6035928	cable trumpet 30T 15m H07 7G1,5 KIT	1
1	6060476	cable trumpet 30T 20m H07 7G1,5 KIT	1
1	6019164	cable trumpet 30T 25m H07 7G1,5 KIT	1
1	6060477	cable trumpet 30T 30m H07 7G1,5 KIT	1
1	6048268	cable trumpet 30T 35m H07 7G1,5 KIT	1
1	6060475	cable trumpet 30T 50m H07 7G1,5 KIT	1
1	6087356	cable trumpet 30T 10m H07 10G1,5 KIT	1
1	6041748	cable trumpet30T 15m H07 10G1,5 KIT	1
1	6080969	cable trumpet30T 20m H07 10G1,5 KIT	1
2	6031795	cable trumpet 30T 15m NSS 4x1,5 KIT	1
2	6040015	cable trumpet 30T 20m NSS 4x1,5 KIT	1
2	6035322	cable trumpet 30T 10m NSS 7x1,5 KIT	1
2	6028732	cable trumpet 30T 20m NSS 7x1,5 KIT	1
2	6026657	cable trumpet 30T 25m NSS 7x,1,5 KIT	1
2	6030434	cable trumpet 30T 15m NSS 7x2,5 KIT	1
3	6068166	cable trumpet 30T 10m 7* AWG 14 KIT	1
4	6042225	cable trumpet 30T 10m H07 7G1,5 C KIT	1
5	6042226	cable trumpet 30T 10m NSS 7x1,5 C KIT	1
5	6063462	cable trumpet 30T 15m NSS 7x1,5 C KIT	1
5	6063021	cable trumpet 30T 20m NSS 7x,1,5 C KIT	1

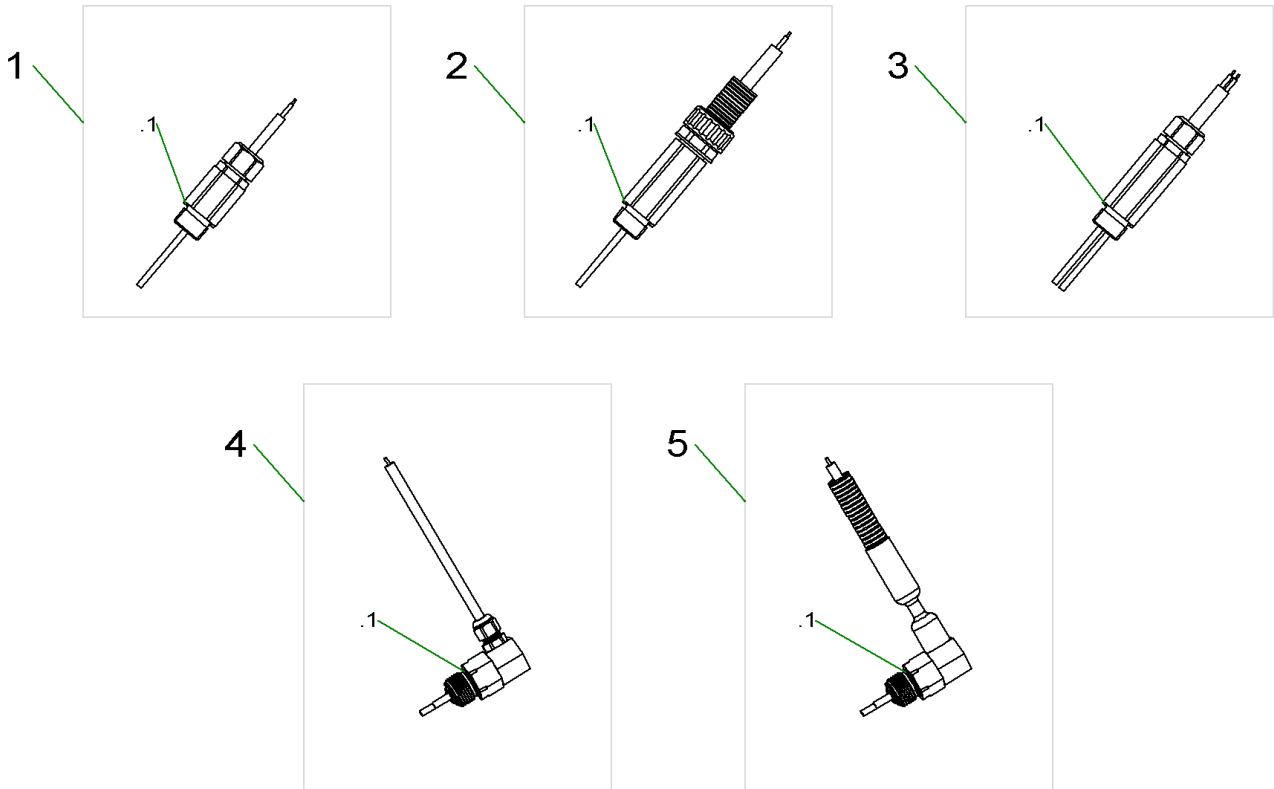

electrode KIT

Item	Article no.	Description	Quantity
.1	6048832	joint ring A21/26x1,5 DIN7603 PA(10pc)	1
1	6042222	pencil electrode G1/2 10m KIT	1
1	6042313	pencil electrode G1/2 15m KIT	1
1	6042223	pencil electrode G1/2 20m KIT	1
1	6061068	pencil electrode G1/2 25KIT	1
1	6061070	pencil electrode G1/2 30m KIT	1
1	6061069	Stabelektrode G1/2 40m SET	1
1	6060956	pencil electrode G1/2 55m KIT	1
2	6042227	pencil electrode G1/2 10m+hose KIT	1
2	6065196	pencil electrode G1/2 15m+hose KIT	1
3	6042229	double pencil electrode G1/2 10m KIT	1
3	6042228	double pencil electrode G1/2 20m KIT	1
3	6063536	double pencil electrode G1/2 40m KIT	1
3	6065157	double pencil electrode G1/2 10m 4*A KIT	1
3	6065156	double pencil electrode G1/2 20m 4*AWKIT	1
4	6068049	elbow pencil electrode G1/2 10m SET	1
4	6068050	elbow pencil electrode G1/2 15m SET	1
4	6075169	elbow pencil electrode G1/2 20m SET	1
5	6068345	elbow pencil electrode G1/2 10m+Schl. KI	1
5	6068346	elbow pencil electrode G1/2 15m+Schl. SE	1

CONTRACTOR'S PUMP KS5 (Bm4) UNIT

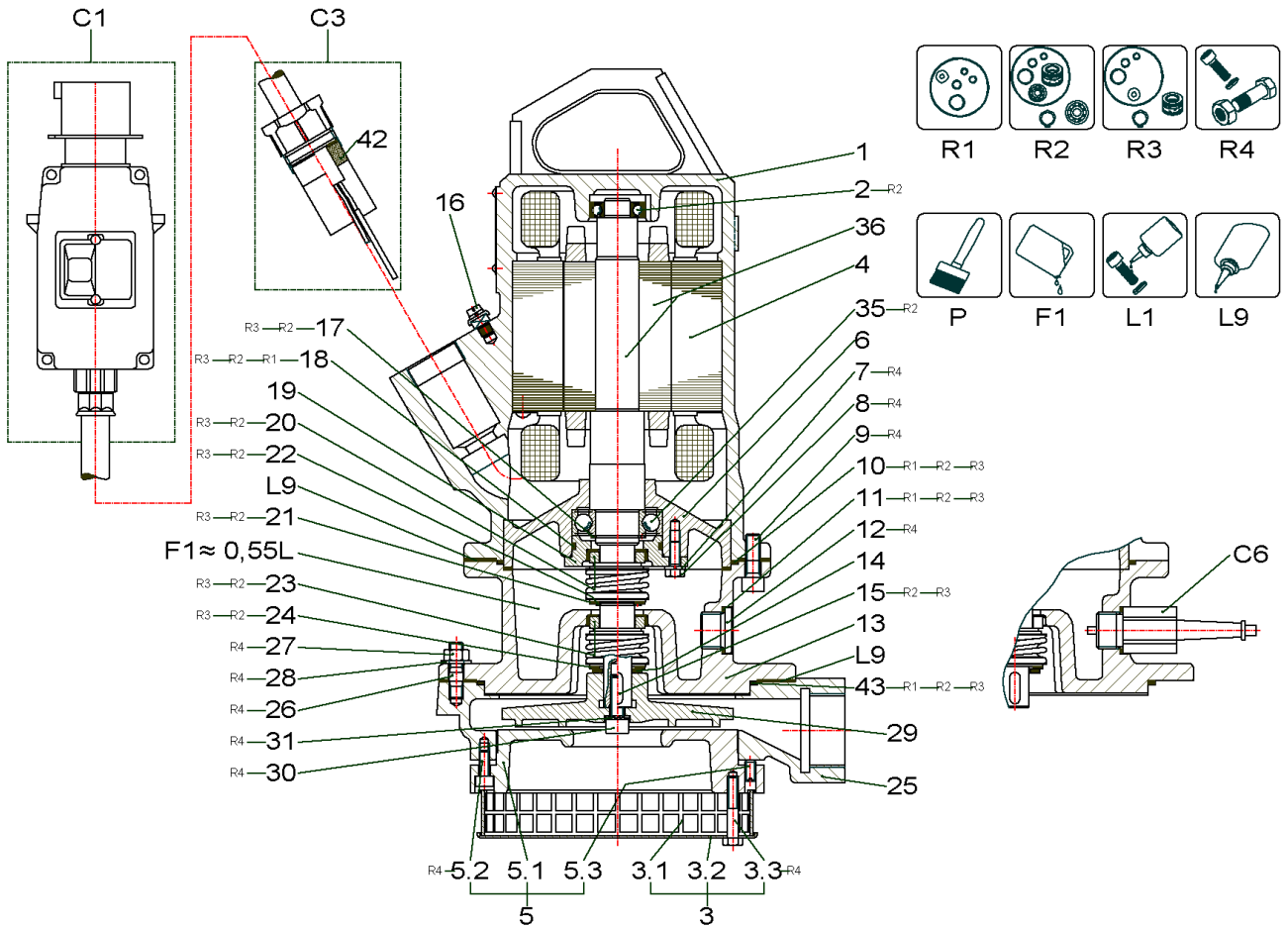

CONTRACTOR'S PUMP KS5 (Bm4) UNIT

Item	Article no.	Description	Quantity
R1	6016204	Rep.Kit 1 T12K, T12G BM2 / BM3 Vit	1
R2	6016074	Rep.Kit 2 T12K;T12G Bm2/Bm3 Vit	1
R3	6016073	Rep.Kit 3 T12K;T12G Bm2/Bm3 Vit	1
R4	6042219	Screws KS5,6,16/T12 KIT	1
P	6042254	PAINT SPRAY Pantone334	1
P	6042255	colour 2K-paint IV80 pantone334C 250ml	1
P	6023614	Ceram C0 black 100 ml KIT	1
P	6020579	Ceram C0 black 250 ml KIT	1
P	6023485	Ceram C0 Black 500ml Kit	1
P	6019157	Ceram C0 black 1000 ml KIT	1
F1	6025460	medical white oil 1L KIT	1
L1	6080531	Loctite 243 5g flask VP:	1
L1	2096167	Loctite 243 50ml VP.	1
L9	6080535	Loctite 5203 300ml VP.	1

C1		PLUG	1
C3		cable trumpet 30T KIT	1
C6		electrode KIT	1

1	6013993	motor casing 50.18026/1 GG	1
2	6086141	ball bearing 6002 VP.	1
36	6010586	rotor D.61,4x265 2/6 1.4021	1
4	6023501	stator T12-2/6 400 50Hz VN01	1
		alternativ / alternative / alternative	
4	6023502	stator T12-2/6 500 50Hz VN01	1
35	2046946	ball bearing 6205/2RS-C3 (HT) VP.	1
6	6085141	bearing housing 53.17238 GG VP.	1
7		lock washer 6 DIN7980 A4	3
8		screw M6x16 DIN933 A2-70 (10pc)	1
9		screw M8x25 DIN912 A4 (10pc)	1
10		o-ring ID.125,0x3,0 Viton	1
11	6048832	joint ring A21/26x1,5 DIN7603 PA(10pc)	1
12	6067638	screw plug G1/2 DIN908 A4 (3pcs)	1
13	6047095	sealing casing D.152g6 52.20035 GG	1

CONTRACTOR'S PUMP KS5 (Bm4) UNIT

Item	Article no.	Description	Quantity
14	6002118	washer 17 DIN433 A2	1
15	6004654	key A 6x4x18 54.2589 A4	1
16	6067407	Barlian bow terminal M5 A2	1
17	6002002	circlips 25x1,2 DIN471 FSt	1
18		-ring ID.44,0x3,0 Viton 75	1
19	6085142	bearing cover D.35H7 53.17239 GG VP.	1
20	6074596	mechanical shaft seal MG1/20-G64 Q1Q1VGG	1
21	6005374	pressure ring 31,6x1 1.4571	1
22	6002006	circlips 20x1,2 DIN471 1.4116	1
23	6074596	mechanical shaft seal MG1/20-G64 Q1Q1VGG	1
24	6005374	pressure ring 31,6x1 1.4571	1
25	6044536	pump housing QG1 1/4 52.18392/1 GG	1
		alternativ / alternative / alternative	
25	6044731	pump housing QG1 1/4 52.18392/1 GG/C0	1
26		screw M8x22 DIN939 A2-70	3
27		nut M8 DIN934 A2-80	3
28		washer A8,4 DIN125 1.4401 (20pc)	1
29	6014148	impeller-W D.113 54.18382 GG	1
		alternativ / alternative / alternative	
29	6014147	impeller-W D.113 54.18382 GG/C0	1
30	6003416	screw M8x25 DIN912 10.9 Geomet	1
31	6002688	screw locking Nord-Lock 13,5/8,7 A4	1
5	6072179	suction port KS5/6 M03-12 53.14379 GG KI	1
5.1		> suction port 53.14379 GG	1
5.2		> screw M6x16 ISO4762 A4	3
5.3		> Stud bolt M8x12 DIN915 A4	3
		alternativ / alternative / alternative	
5.1	6012770	suction port 53.14379 GG/C0	1
3	6072178	strainer KS5/6 M03-12 1.4301 KIT	1
3.1		> strainer 26x155x2 1.4301	1
3.2		> base plate D.160x3 1,5 1.4301	1
3.3		> screw M6x35 ISO4014 A4-70	3
		alternativ / alternative / alternative	
3.1	6013182	strainer 26x155x2 54.10534/1 1.4301 C0	1

CONTRACTOR'S PUMP KS5 (Bm4) UNIT

Item	Article no.	Description	Quantity
3.2	6017621	base plate D.160x3 53.10536/1 1.4301/C0	1
42	6076649	seal ring D.29,5/16x16,5 54.17777NBR VP.	1
42	6076650	seal ring D.29,5/17x16,5 54.17777 NBR VP	1
42	6076651	seal ring D.29,5/19x16,5 54.17777NBR VP.	1
		alternativ / alternative / alternative	
42	6037031	seal ring D.29,5/16x16,5 CR silicon free	1
42	6037478	seal ring D.29,5/19x16,5 CR silicon free	1
43	6007641	o-ring ID.150,0x3,0 Viton	1

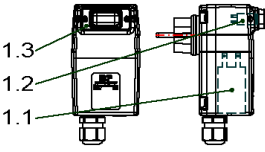
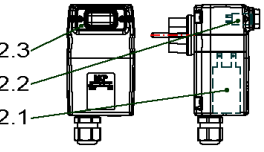
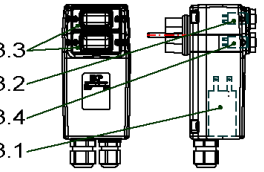
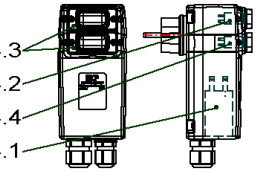
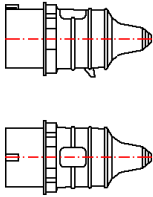
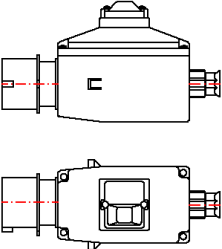
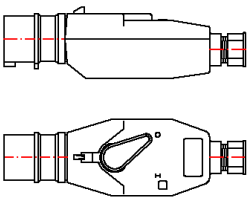
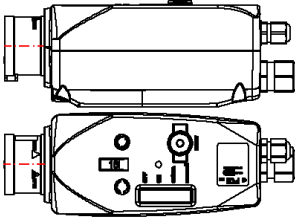
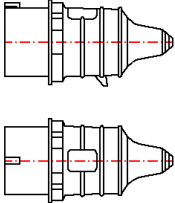
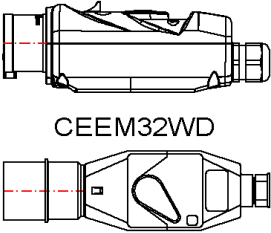
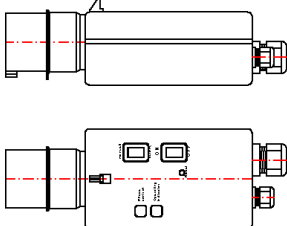
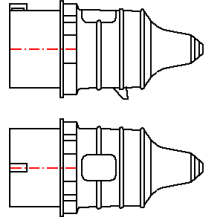
<p>1 MCP 6A-M-H-20μF ~ 230V</p>  <p>$I_N(230V / 50Hz) < 6A = 20\mu F$</p>	<p>2 MCP 10A-M-H-30μF ~ 230V</p>  <p>$I_N(230V / 50Hz) 6-10A = 30\mu F$</p>	<p>3 MCP 6A-M-HA-20μF ~ 230V</p>  <p>$I_N(230V / 50Hz) < 6A = 20\mu F$</p>	<p>4 MCP 10A-M-HA-30μF ~ 230V</p>  <p>$I_N(230V / 50Hz) 6-10A = 30\mu F$</p>
<p>5 CEE16A</p> 	<p>6 CEEM16W</p> 	<p>7 CEEM16WD</p> 	<p>8 MCP T4-HA-ROT-WSK CEE16-5PS</p> 
<p>9 CEE32A</p> 	<p>10 MCP 10-16A-T4-H-ROT CEE32-5PS</p>  <p>CEEM32WD</p>	<p>11 CEEM32WDSHA</p> 	<p>12 CEE63A</p> 

PLUG

Item	Article no.	Description	Quantity
		IN (230V / 50Hz) <6A - 20μF	
1	6072332	MCP 6A-M-H-20μF-CEE7/7 VP.	1
1.1	6071702	capacitor 400V 20μF MCP VP.	1
1.2	6071704	protection switch 6A MCP VP.	1
1.3	6071707	protecting cap MCP VP.	1
		IN (230V / 50Hz) 6-10A - 30μF	
2	6072330	MCP 10A-M-H-30μF-CEE7/7 VP.	1
2.1	6071703	capacitor 400V 30μF MCP VP.	1
2.2	6071705	protection switch 10A MCP VP.	1
2.3	6071707	protecting cap MCP VP.	1
		IN (230V / 50Hz) <6A - 20μF	
3	6072331	MCP 6A-M-HA-20μF-CEE7/7 VP.	1
3.1	6071702	capacitor 400V 20μF MCP VP.	1
3.2	6071704	protection switch 6A MCP VP.	1
3.3	6071707	protecting cap MCP VP.	2
3.4	6071706	switch on/out MCP VP.	1
		IN (230V / 50Hz) 6-10A - 30μF	
4	6072329	MCP 10A-M-HA-30μF-CEE7/7 VP	1
4.1	6071703	capacitor 400V 30μF MCP VP.	1
4.2	6071705	protection switch 10A MCP VP.	1
4.3	6071707	protecting cap MCP VP.	2
4.4	6071706	switch on/out MCP VP.	1
5	6003000	plug CEE16A/400V 60Hz/5P-11h	1
5	6003248	plug CEE16A/400V/4P-6H	1
5	6003009	plug CEE16A/400V/5P-6H	1
5	6039156	plug CEE16A/400V/5P-6H Phase inverter	1
5	6035231	plug CEE16A/400V/7P-6H	1
5	6003011	plug CEE16A/500V/5P-7H	1
6	6030883	plug MS400V5P CEE16A W 1,0-1,6A	1
6	6030884	plug MS400V5P CEE16A W 1,6-2,5A	1
6	6030888	plug MS400V5P CEE16A W 10,0-16,0A	1
6	6030885	plug MS400V5P CEE16A W 2,5-4,0A	1
6	6030886	plug MS400V5P CEE16A W 4,0-6,3A	1
6	6030887	plug MS400V5P CEE16A W 6,3-10,0A	1



PLUG

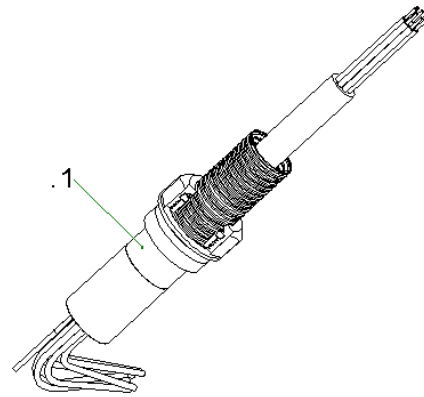
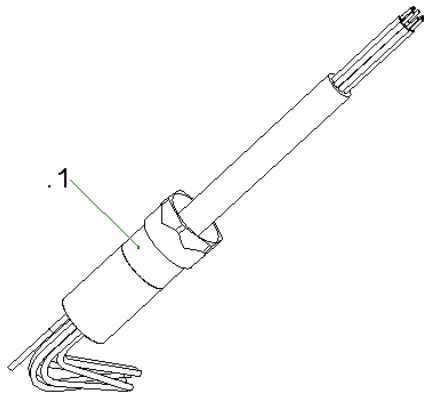

Item	Article no.	Description	Quantity
7	6032446	plug MS400V4P CEE16A WD 1,6-2,5A	1
7	6032447	plug MS400V4P CEE16A WD 12,5-16,0A	1
7	6032295	plug MS400V4P CEE16A WD 2,5-4,0A	1
7	6032289	plug MS400V4P CEE16A WD 4,0-6,3A	1
7	6032292	plug MS400V4P CEE16A WD 6,3-9,0A	1
7	6042190	plug MS400V5P CEE16A WDII 1,6-2,5A	1
7	6042194	plug MS400V5P CEE16A WDII 10,0-16,0A	1
7	6042191	plug MS400V5P CEE16A WDII 2,5-4,0A	1
7	6042192	plug MS400V5P CEE16A WDII 4,0-6,3A	1
7	6042193	plug MS400V5P CEE16A WDII 6,3-10,0A	1
7	6035911	plug MS400V5P CEE16A WD 9,0-12,5A	1
7	6003337	plug MS500V5P CEE16A WD 1,6-2,5A	1
7	6003336	plug MS500V5P CEE16A WD 2,5-4,0A	1
7	6003335	plug MS500V5P CEE16A WD 4,0-6,3A	1
7	6003334	plug MS500V5P CEE16A WD 6,3-9,0A	1
8	6072520	MCP 1,0-1,6A-T4-HA-ROT-WSK-CEE16-5PS VP.	1
8	6072521	MCP 1,6-2,4A-T4-HA-ROT-WSK-CEE16-5PS VP.	1
8	6072522	MCP 2,4-4,0A-T4-HA-ROT-WSK-CEE16-5PS VP.	1
8	6072523	MCP 4,0-6,0A-T4-HA-ROT-WSK-CEE16-5PS VP.	1
8	6072524	MCP 6,0-10A-T4-HA-ROT-WSK-CEE16-5PS VP.	1
8	6072525	MCP 9,0-12A-T4-HA-ROT-WSK-CEE16-5PS VP.	1
8	6072526	MCP 12-16A-T4-HA-ROT-WSK-CEE16-5PS VP.	1
9	6003267	plug CEE32A/400V/4P-6H	1
9	6039155	plug CEE32A/400V/5P-6H Phase inverter	1
9	6035895	plug CEE32A/500V/4P-7H AM-Top	1
9	6003010	plug CEE32A/500V/5P-7H	1
10	6072370	MCP 400V 1,6-2,5A-T4-H-ROT-CEE32-5PS VP.	1
10	6072369	MCP 400V 2,5-4,0A-T4-H-ROT-CEE32-5PS VP.	1
10	6072371	MCP 400V 4,0-6,3A-T4-H-ROT-CEE32-5PS VP.	1
10	6072398	MCP 400V 6,3-10A-T4-H-ROT-CEE32-5PS VP.	1
10	6072519	MCP 400V 10-16A-T4-H-ROT-CEE32-5PS VP.	1
10	6072399	MCP 400V 16-20A-T4-H-ROT-CEE32-5PS VP.	1
10	6072518	MCP 400V 20-25A-T4-H-ROT-CEE32-5PS VP.	1
10	6037649	plug.MS500V4P CEE32A WD 2,5-4,0A	1

PLUG

Item	Article no.	Description	Quantity
10	6041268	plug MS500V4P CEE32A WD 4,0-6,3A	1
10	6035244	plug MS500V5P CEE32A WD 1,6-2,5A	1
10	6034700	plug MS500V5P CEE32A WD 2,5-4,0A	1
10	6041556	plug MS500V5P CEE32A WD 4,0-6,3A	1
10	6002701	plug MS500V5P CEE32A WD 9,0-12,5A	1
10	6002700	plug MS500V5P CEE32A WD 12,5-16,0A	1
11	6003241	plug MS400V5P CEE32A WDSHA 10,0-14,0A	1
11	6003266	plug MS400V5P CEE32A WDSHA 3,7-5,5A	1
11	6003265	plug MS400V5P CEE32A WDSHA 5,5-8,0A	1
11	6003264	plug MS400V5P CEE32A WDSHA 8,0-11,5A	1
12	6003012	plug CEE63A/400V/5P-6H/IP67	1



- 1  H07RN-F
- 2  NSSHOEU-J
- 3  SOOW

- 4  H07RN-F
- 5  NSSHOEU-J

cable trumpet 30T KIT

Item	Article no.	Description	Quantity
.1	6076649	seal ring D.29,5/16x16,5 54.17777NBR VP.	1
.1	6076650	seal ring D.29,5/17x16,5 54.17777 NBR VP	1
.1	6076651	seal ring D.29,5/19x16,5 54.17777NBR VP.	1
		alternativ / alternative / alternative	
.1	6037031	seal ring D.29,5/16x16,5 CR silicon free	1
.1	6037478	seal ring D.29,5/19x16,5 CR silicon free	1
1	6022379	cable trumpet 30T 5m H07 7G1,5 KIT	1
1	6019236	cable trumpet 30T 10m H07 7G1,5 KIT	1
1	6035928	cable trumpet 30T 15m H07 7G1,5 KIT	1
1	6060476	cable trumpet 30T 20m H07 7G1,5 KIT	1
1	6019164	cable trumpet 30T 25m H07 7G1,5 KIT	1
1	6060477	cable trumpet 30T 30m H07 7G1,5 KIT	1
1	6048268	cable trumpet 30T 35m H07 7G1,5 KIT	1
1	6060475	cable trumpet 30T 50m H07 7G1,5 KIT	1
1	6087356	cable trumpet 30T 10m H07 10G1,5 KIT	1
1	6041748	cable trumpet30T 15m H07 10G1,5 KIT	1
1	6080969	cable trumpet30T 20m H07 10G1,5 KIT	1
2	6031795	cable trumpet 30T 15m NSS 4x1,5 KIT	1
2	6040015	cable trumpet 30T 20m NSS 4x1,5 KIT	1
2	6035322	cable trumpet 30T 10m NSS 7x1,5 KIT	1
2	6028732	cable trumpet 30T 20m NSS 7x1,5 KIT	1
2	6026657	cable trumpet 30T 25m NSS 7x,1,5 KIT	1
2	6030434	cable trumpet 30T 15m NSS 7x2,5 KIT	1
3	6068166	cable trumpet 30T 10m 7* AWG 14 KIT	1
4	6042225	cable trumpet 30T 10m H07 7G1,5 C KIT	1
5	6042226	cable trumpet 30T 10m NSS 7x1,5 C KIT	1
5	6063462	cable trumpet 30T 15m NSS 7x1,5 C KIT	1
5	6063021	cable trumpet 30T 20m NSS 7x,1,5 C KIT	1

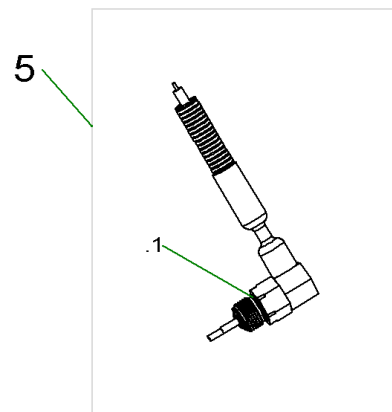
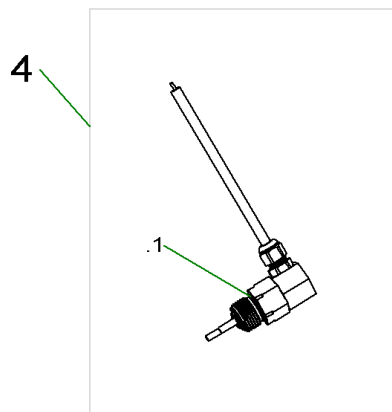
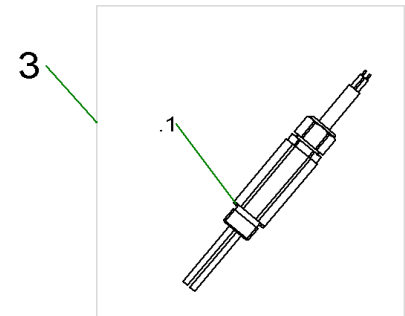
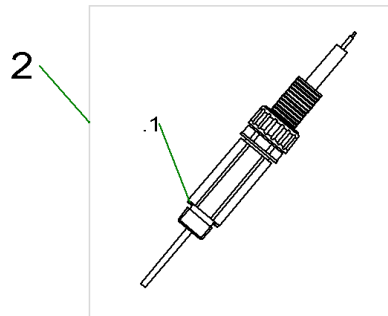
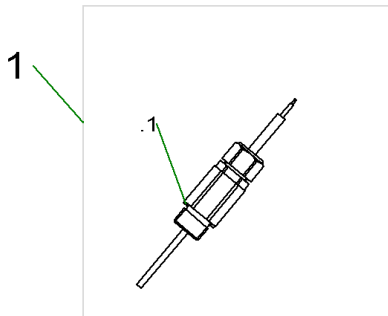

electrode KIT

Item	Article no.	Description	Quantity
.1	6048832	joint ring A21/26x1,5 DIN7603 PA(10pc)	1
1	6042222	pencil electrode G1/2 10m KIT	1
1	6042313	pencil electrode G1/2 15m KIT	1
1	6042223	pencil electrode G1/2 20m KIT	1
1	6061068	pencil electrode G1/2 25KIT	1
1	6061070	pencil electrode G1/2 30m KIT	1
1	6061069	Stabelektrode G1/2 40m SET	1
1	6060956	pencil electrode G1/2 55m KIT	1
2	6042227	pencil electrode G1/2 10m+hose KIT	1
2	6065196	pencil electrode G1/2 15m+hose KIT	1
3	6042229	double pencil electrode G1/2 10m KIT	1
3	6042228	double pencil electrode G1/2 20m KIT	1
3	6063536	double pencil electrode G1/2 40m KIT	1
3	6065157	double pencil electrode G1/2 10m 4*A KIT	1
3	6065156	double pencil electrode G1/2 20m 4*AWKIT	1
4	6068049	elbow pencil electrode G1/2 10m SET	1
4	6068050	elbow pencil electrode G1/2 15m SET	1
4	6075169	elbow pencil electrode G1/2 20m SET	1
5	6068345	elbow pencil electrode G1/2 10m+Schl. KI	1
5	6068346	elbow pencil electrode G1/2 15m+Schl. SE	1

KS6

Bm3

S/N < 650056830

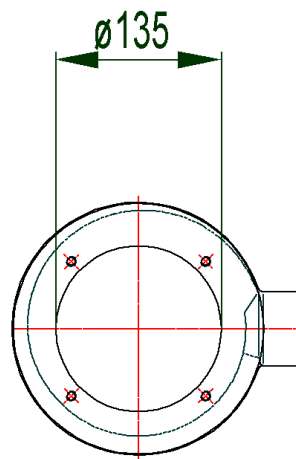
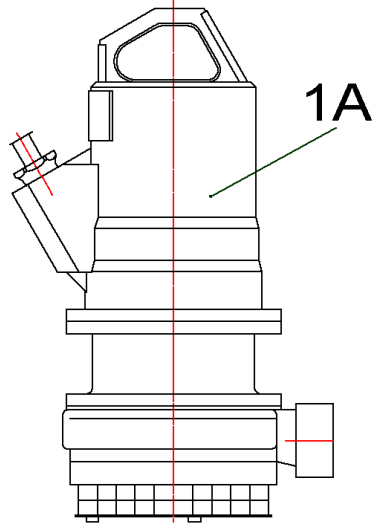

Bm4

S/N > 650056831

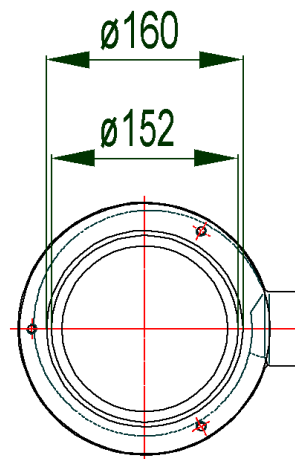
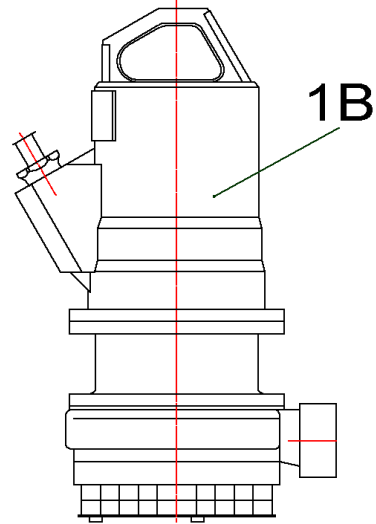

CONTRACTOR'S PUMP KS6 UNIT (6000105)

Item	Description	Quantity
1A	CONTRACTOR'S PUMP KS6 (Bm3) UNIT	1
1B	CONTRACTOR'S PUMP KS6 (Bm4) UNIT	1

CONTRACTOR'S PUMP KS6 (Bm3) UNIT

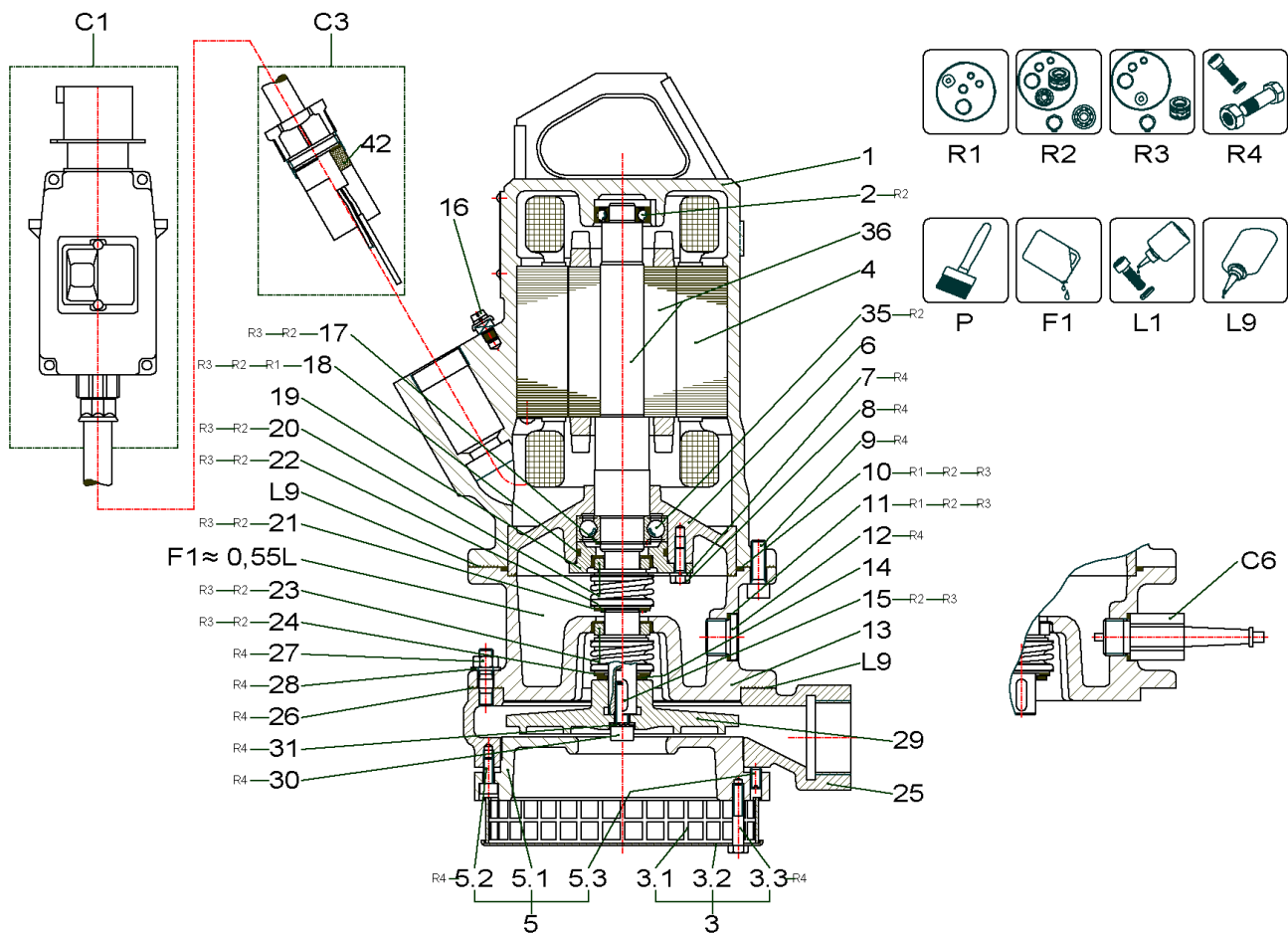

CONTRACTOR'S PUMP KS6 (Bm3) UNIT

Item	Article no.	Description	Quantity
R1	6016204	Rep.Kit 1 T12K, T12G BM2 / BM3 Vit	1
R2	6016074	Rep.Kit 2 T12K;T12G Bm2/Bm3 Vit	1
R3	6016073	Rep.Kit 3 T12K;T12G Bm2/Bm3 Vit	1
R4	6042219	Screws KS5,6,16/T12 KIT	1
P	6042254	PAINT SPRAY Pantone334	1
P	6042255	colour 2K-paint IV80 pantone334C 250ml	1
P	6023614	Ceram C0 black 100 ml KIT	1
P	6020579	Ceram C0 black 250 ml KIT	1
P	6023485	Ceram C0 Black 500ml Kit	1
P	6019157	Ceram C0 black 1000 ml KIT	1
F1	6025460	medical white oil 1L KIT	1
L1	6080531	Loctite 243 5g flask VP:	1
L1	2096167	Loctite 243 50ml VP.	1
L9	6080535	Loctite 5203 300ml VP.	1

C1		PLUG	1
C3		cable trumpet 30T KIT	1
C6		electrode KIT	1

1	6013993	motor casing 50.18026/1 GG	1
2	6086141	ball bearing 6002 VP.	1
36	6010586	rotor D.61,4x265 2/6 1.4021	1
4	6023501	stator T12-2/6 400 50Hz VN01	1
		alternativ / alternative / alternative	
4	6023502	stator T12-2/6 500 50Hz VN01	1
35	2046946	ball bearing 6205/2RS-C3 (HT) VP.	1
6	6085141	bearing housing 53.17238 GG VP.	1
7		lock washer 6 DIN7980 A4	3
8		screw M6x16 DIN933 A2-70 (10pc)	1
9		screw M8x25 DIN912 A4 (10pc)	1
10		o-ring ID.125,0x3,0 Viton	1
11	6048832	joint ring A21/26x1,5 DIN7603 PA(10pc)	1
12	6067638	screw plug G1/2 DIN908 A4 (3pcs)	1
13	6013686	sealing casing D.135g6 52.17240 GG	1

CONTRACTOR'S PUMP KS6 (Bm3) UNIT

Item	Article no.	Description	Quantity
		alternativ / alternative / alternative	
13	6013684	sealing casing D.135g6 52.17240 GG/C0	1
13	6013685	sealing casing D.135g6 52.17240 GG/C1	1
14	6002118	washer 17 DIN433 A2	1
15	6004654	key A 6x4x18 54.2589 A4	1
16	6067407	Barlian bow terminal M5 A2	1
17	6002002	circlips 25x1,2 DIN471 FSt	1
18		-ring ID.44,0x3,0 Viton 75	1
19	6085142	bearing cover D.35H7 53.17239 GG VP.	1
20	6074596	mechanical shaft seal MG1/20-G64 Q1Q1VGG	1
21	6005374	pressure ring 31,6x1 1.4571	1
22	6002006	circlips 20x1,2 DIN471 1.4116	1
23	6074596	mechanical shaft seal MG1/20-G64 Q1Q1VGG	1
24	6005374	pressure ring 31,6x1 1.4571	1
25	6012676	pump housing QG1 1/4 52.18392 GG	1
		alternativ / alternative / alternative	
25	6012675	pump housing QG1 1/4 52.18392 GG/C0	1
26		screw M8x22 DIN939 A2-70	4
27		nut M8 DIN934 A2-80	4
28		washer A8,4 DIN125 1.4401 (20pc)	1
29	6014155	impeller-W D.132 54.18383 GG	1
		alternativ / alternative / alternative	
29	6021746	impeller-W D.132 54.18383 GG/C0	1
30	6003416	screw M8x25 DIN912 10.9 Geomet	1
31	6002688	screw locking Nord-Lock 13,5/8,7 A4	1
5	6072179	suction port KS5/6 M03-12 53.14379 GG KI	1
5.1		> suction port 53.14379 GG	1
5.2		> screw M6x16 ISO4762 A4	3
5.3		> Stud bolt M8x12 DIN915 A4	3
		alternativ / alternative / alternative	
5.1	6012770	suction port 53.14379 GG/C0	1
3	6072178	strainer KS5/6 M03-12 1.4301 KIT	1
3.1		> strainer 26x155x2 1.4301	1
3.2		> base plate D.160x3 1,5 1.4301	1

CONTRACTOR'S PUMP KS6 (Bm3) UNIT

Item	Article no.	Description	Quantity
3.3		> screw M6x35 ISO4014 A4-70	3
		alternativ / alternative / alternative	
3.1	6013182	strainer 26x155x2 54.10534/1 1.4301 C0	1
3.2	6017621	base plate D.160x3 53.10536/1 1.4301/C0	1
42	6076649	seal ring D.29,5/16x16,5 54.17777NBR VP.	1
42	6076650	seal ring D.29,5/17x16,5 54.17777 NBR VP	1
42	6076651	seal ring D.29,5/19x16,5 54.17777NBR VP.	1
		alternativ / alternative / alternative	
42	6037031	seal ring D.29,5/16x16,5 CR silicon free	1
42	6037478	seal ring D.29,5/19x16,5 CR silicon free	1

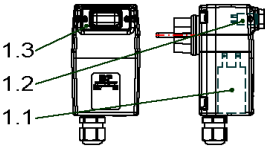
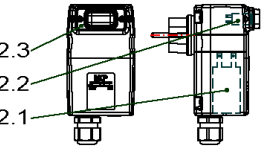
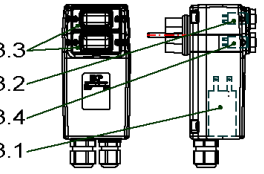
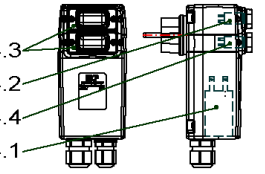
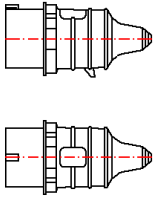
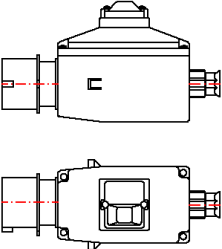
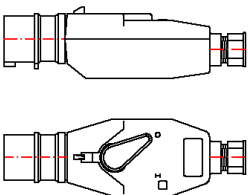
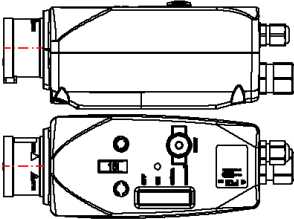
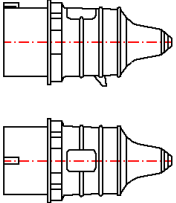
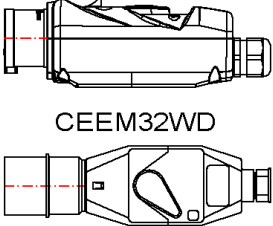
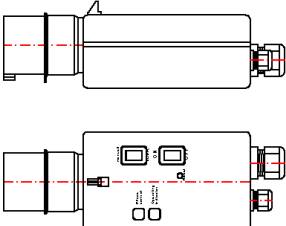
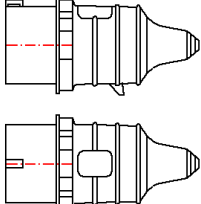
<p>1 MCP 6A-M-H-20μF ~ 230V</p>  <p>$I_N(230V / 50Hz) < 6A = 20\mu F$</p>	<p>2 MCP 10A-M-H-30μF ~ 230V</p>  <p>$I_N(230V / 50Hz) 6-10A = 30\mu F$</p>	<p>3 MCP 6A-M-HA-20μF ~ 230V</p>  <p>$I_N(230V / 50Hz) < 6A = 20\mu F$</p>	<p>4 MCP 10A-M-HA-30μF ~ 230V</p>  <p>$I_N(230V / 50Hz) 6-10A = 30\mu F$</p>
<p>5 CEE16A</p> 	<p>6 CEEM16W</p> 	<p>7 CEEM16WD</p> 	<p>8 MCP T4-HA-ROT-WSK CEE16-5PS</p> 
<p>9 CEE32A</p> 	<p>10 MCP 10-16A-T4-H-ROT CEE32-5PS</p>  <p>CEEM32WD</p>	<p>11 CEEM32WDSHA</p> 	<p>12 CEE63A</p> 

PLUG

Item	Article no.	Description	Quantity
		IN (230V / 50Hz) <6A - 20μF	
1	6072332	MCP 6A-M-H-20μF-CEE7/7 VP.	1
1.1	6071702	capacitor 400V 20μF MCP VP.	1
1.2	6071704	protection switch 6A MCP VP.	1
1.3	6071707	protecting cap MCP VP.	1
		IN (230V / 50Hz) 6-10A - 30μF	
2	6072330	MCP 10A-M-H-30μF-CEE7/7 VP.	1
2.1	6071703	capacitor 400V 30μF MCP VP.	1
2.2	6071705	protection switch 10A MCP VP.	1
2.3	6071707	protecting cap MCP VP.	1
		IN (230V / 50Hz) <6A - 20μF	
3	6072331	MCP 6A-M-HA-20μF-CEE7/7 VP.	1
3.1	6071702	capacitor 400V 20μF MCP VP.	1
3.2	6071704	protection switch 6A MCP VP.	1
3.3	6071707	protecting cap MCP VP.	2
3.4	6071706	switch on/out MCP VP.	1
		IN (230V / 50Hz) 6-10A - 30μF	
4	6072329	MCP 10A-M-HA-30μF-CEE7/7 VP	1
4.1	6071703	capacitor 400V 30μF MCP VP.	1
4.2	6071705	protection switch 10A MCP VP.	1
4.3	6071707	protecting cap MCP VP.	2
4.4	6071706	switch on/out MCP VP.	1
5	6003000	plug CEE16A/400V 60Hz/5P-11h	1
5	6003248	plug CEE16A/400V/4P-6H	1
5	6003009	plug CEE16A/400V/5P-6H	1
5	6039156	plug CEE16A/400V/5P-6H Phase inverter	1
5	6035231	plug CEE16A/400V/7P-6H	1
5	6003011	plug CEE16A/500V/5P-7H	1
6	6030883	plug MS400V5P CEE16A W 1,0-1,6A	1
6	6030884	plug MS400V5P CEE16A W 1,6-2,5A	1
6	6030888	plug MS400V5P CEE16A W 10,0-16,0A	1
6	6030885	plug MS400V5P CEE16A W 2,5-4,0A	1
6	6030886	plug MS400V5P CEE16A W 4,0-6,3A	1
6	6030887	plug MS400V5P CEE16A W 6,3-10,0A	1

PLUG

Item	Article no.	Description	Quantity
7	6032446	plug MS400V4P CEE16A WD 1,6-2,5A	1
7	6032447	plug MS400V4P CEE16A WD 12,5-16,0A	1
7	6032295	plug MS400V4P CEE16A WD 2,5-4,0A	1
7	6032289	plug MS400V4P CEE16A WD 4,0-6,3A	1
7	6032292	plug MS400V4P CEE16A WD 6,3-9,0A	1
7	6042190	plug MS400V5P CEE16A WDII 1,6-2,5A	1
7	6042194	plug MS400V5P CEE16A WDII 10,0-16,0A	1
7	6042191	plug MS400V5P CEE16A WDII 2,5-4,0A	1
7	6042192	plug MS400V5P CEE16A WDII 4,0-6,3A	1
7	6042193	plug MS400V5P CEE16A WDII 6,3-10,0A	1
7	6035911	plug MS400V5P CEE16A WD 9,0-12,5A	1
7	6003337	plug MS500V5P CEE16A WD 1,6-2,5A	1
7	6003336	plug MS500V5P CEE16A WD 2,5-4,0A	1
7	6003335	plug MS500V5P CEE16A WD 4,0-6,3A	1
7	6003334	plug MS500V5P CEE16A WD 6,3-9,0A	1
8	6072520	MCP 1,0-1,6A-T4-HA-ROT-WSK-CEE16-5PS VP.	1
8	6072521	MCP 1,6-2,4A-T4-HA-ROT-WSK-CEE16-5PS VP.	1
8	6072522	MCP 2,4-4,0A-T4-HA-ROT-WSK-CEE16-5PS VP.	1
8	6072523	MCP 4,0-6,0A-T4-HA-ROT-WSK-CEE16-5PS VP.	1
8	6072524	MCP 6,0-10A-T4-HA-ROT-WSK-CEE16-5PS VP.	1
8	6072525	MCP 9,0-12A-T4-HA-ROT-WSK-CEE16-5PS VP.	1
8	6072526	MCP 12-16A-T4-HA-ROT-WSK-CEE16-5PS VP.	1
9	6003267	plug CEE32A/400V/4P-6H	1
9	6039155	plug CEE32A/400V/5P-6H Phase inverter	1
9	6035895	plug CEE32A/500V/4P-7H AM-Top	1
9	6003010	plug CEE32A/500V/5P-7H	1
10	6072370	MCP 400V 1,6-2,5A-T4-H-ROT-CEE32-5PS VP.	1
10	6072369	MCP 400V 2,5-4,0A-T4-H-ROT-CEE32-5PS VP.	1
10	6072371	MCP 400V 4,0-6,3A-T4-H-ROT-CEE32-5PS VP.	1
10	6072398	MCP 400V 6,3-10A-T4-H-ROT-CEE32-5PS VP.	1
10	6072519	MCP 400V 10-16A-T4-H-ROT-CEE32-5PS VP.	1
10	6072399	MCP 400V 16-20A-T4-H-ROT-CEE32-5PS VP.	1
10	6072518	MCP 400V 20-25A-T4-H-ROT-CEE32-5PS VP.	1
10	6037649	plug.MS500V4P CEE32A WD 2,5-4,0A	1

PLUG

Item	Article no.	Description	Quantity
10	6041268	plug MS500V4P CEE32A WD 4,0-6,3A	1
10	6035244	plug MS500V5P CEE32A WD 1,6-2,5A	1
10	6034700	plug MS500V5P CEE32A WD 2,5-4,0A	1
10	6041556	plug MS500V5P CEE32A WD 4,0-6,3A	1
10	6002701	plug MS500V5P CEE32A WD 9,0-12,5A	1
10	6002700	plug MS500V5P CEE32A WD 12,5-16,0A	1
11	6003241	plug MS400V5P CEE32A WDSHA 10,0-14,0A	1
11	6003266	plug MS400V5P CEE32A WDSHA 3,7-5,5A	1
11	6003265	plug MS400V5P CEE32A WDSHA 5,5-8,0A	1
11	6003264	plug MS400V5P CEE32A WDSHA 8,0-11,5A	1
12	6003012	plug CEE63A/400V/5P-6H/IP67	1

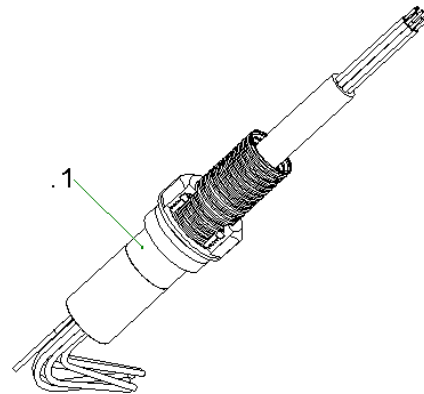
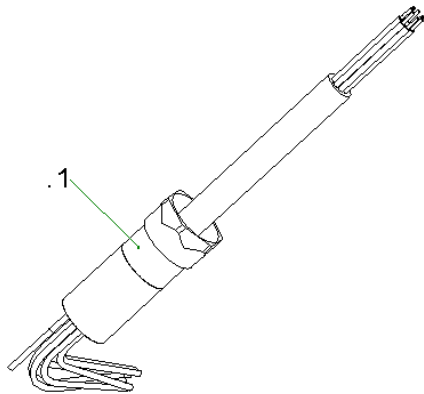

- 1 H07RN-F
- 2 NSSHOEU-J
- 3 SOOW

- 4 H07RN-F
- 5 NSSHOEU-J

cable trumpet 30T KIT

Item	Article no.	Description	Quantity
.1	6076649	seal ring D.29,5/16x16,5 54.17777NBR VP.	1
.1	6076651	seal ring D.29,5/19x16,5 54.17777NBR VP.	1
.1	6076650	seal ring D.29,5/17x16,5 54.17777 NBR VP	1
		alternativ / alternative / alternative	
.1	6037031	seal ring D.29,5/16x16,5 CR silicon free	1
.1	6037478	seal ring D.29,5/19x16,5 CR silicon free	1
1	6022379	cable trumpet 30T 5m H07 7G1,5 KIT	1
1	6019236	cable trumpet 30T 10m H07 7G1,5 KIT	1
1	6035928	cable trumpet 30T 15m H07 7G1,5 KIT	1
1	6060476	cable trumpet 30T 20m H07 7G1,5 KIT	1
1	6019164	cable trumpet 30T 25m H07 7G1,5 KIT	1
1	6060477	cable trumpet 30T 30m H07 7G1,5 KIT	1
1	6048268	cable trumpet 30T 35m H07 7G1,5 KIT	1
1	6060475	cable trumpet 30T 50m H07 7G1,5 KIT	1
1	6087356	cable trumpet 30T 10m H07 10G1,5 KIT	1
1	6041748	cable trumpet30T 15m H07 10G1,5 KIT	1
1	6080969	cable trumpet30T 20m H07 10G1,5 KIT	1
2	6031795	cable trumpet 30T 15m NSS 4x1,5 KIT	1
2	6040015	cable trumpet 30T 20m NSS 4x1,5 KIT	1
2	6035322	cable trumpet 30T 10m NSS 7x1,5 KIT	1
2	6028732	cable trumpet 30T 20m NSS 7x1,5 KIT	1
2	6026657	cable trumpet 30T 25m NSS 7x,1,5 KIT	1
2	6030434	cable trumpet 30T 15m NSS 7x2,5 KIT	1
3	6068166	cable trumpet 30T 10m 7* AWG 14 KIT	1
4	6042225	cable trumpet 30T 10m H07 7G1,5 C KIT	1
5	6042226	cable trumpet 30T 10m NSS 7x1,5 C KIT	1
5	6063462	cable trumpet 30T 15m NSS 7x1,5 C KIT	1
5	6063021	cable trumpet 30T 20m NSS 7x,1,5 C KIT	1

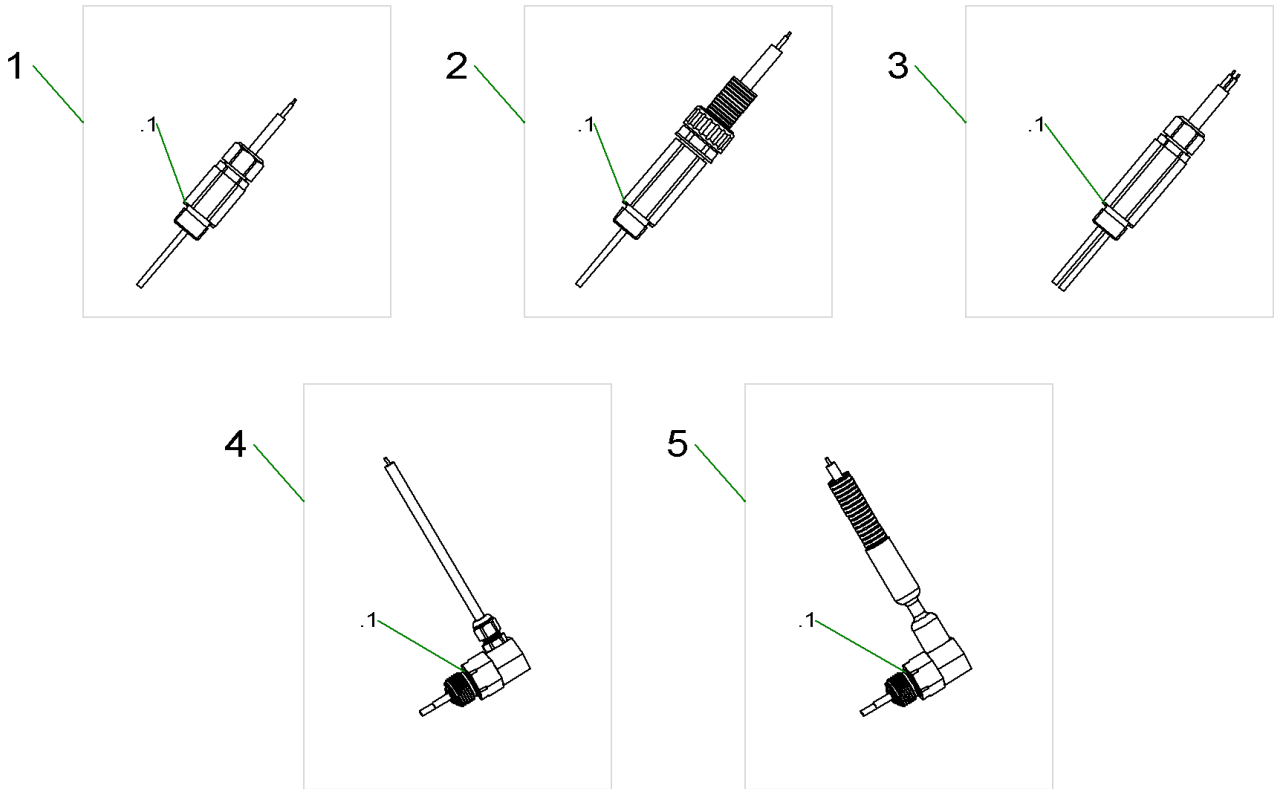

electrode KIT

Item	Article no.	Description	Quantity
.1	6048832	joint ring A21/26x1,5 DIN7603 PA(10pc)	1
1	6042222	pencil electrode G1/2 10m KIT	1
1	6042313	pencil electrode G1/2 15m KIT	1
1	6042223	pencil electrode G1/2 20m KIT	1
1	6061068	pencil electrode G1/2 25KIT	1
1	6061070	pencil electrode G1/2 30m KIT	1
1	6061069	Stabelektrode G1/2 40m SET	1
1	6060956	pencil electrode G1/2 55m KIT	1
2	6042227	pencil electrode G1/2 10m+hose KIT	1
2	6065196	pencil electrode G1/2 15m+hose KIT	1
3	6042229	double pencil electrode G1/2 10m KIT	1
3	6042228	double pencil electrode G1/2 20m KIT	1
3	6063536	double pencil electrode G1/2 40m KIT	1
3	6065157	double pencil electrode G1/2 10m 4*A KIT	1
3	6065156	double pencil electrode G1/2 20m 4*AWKIT	1
4	6068049	elbow pencil electrode G1/2 10m SET	1
4	6068050	elbow pencil electrode G1/2 15m SET	1
4	6075169	elbow pencil electrode G1/2 20m SET	1
5	6068345	elbow pencil electrode G1/2 10m+Schl. KI	1
5	6068346	elbow pencil electrode G1/2 15m+Schl. SE	1

CONTRACTOR'S PUMP KS6 (Bm4) UNIT

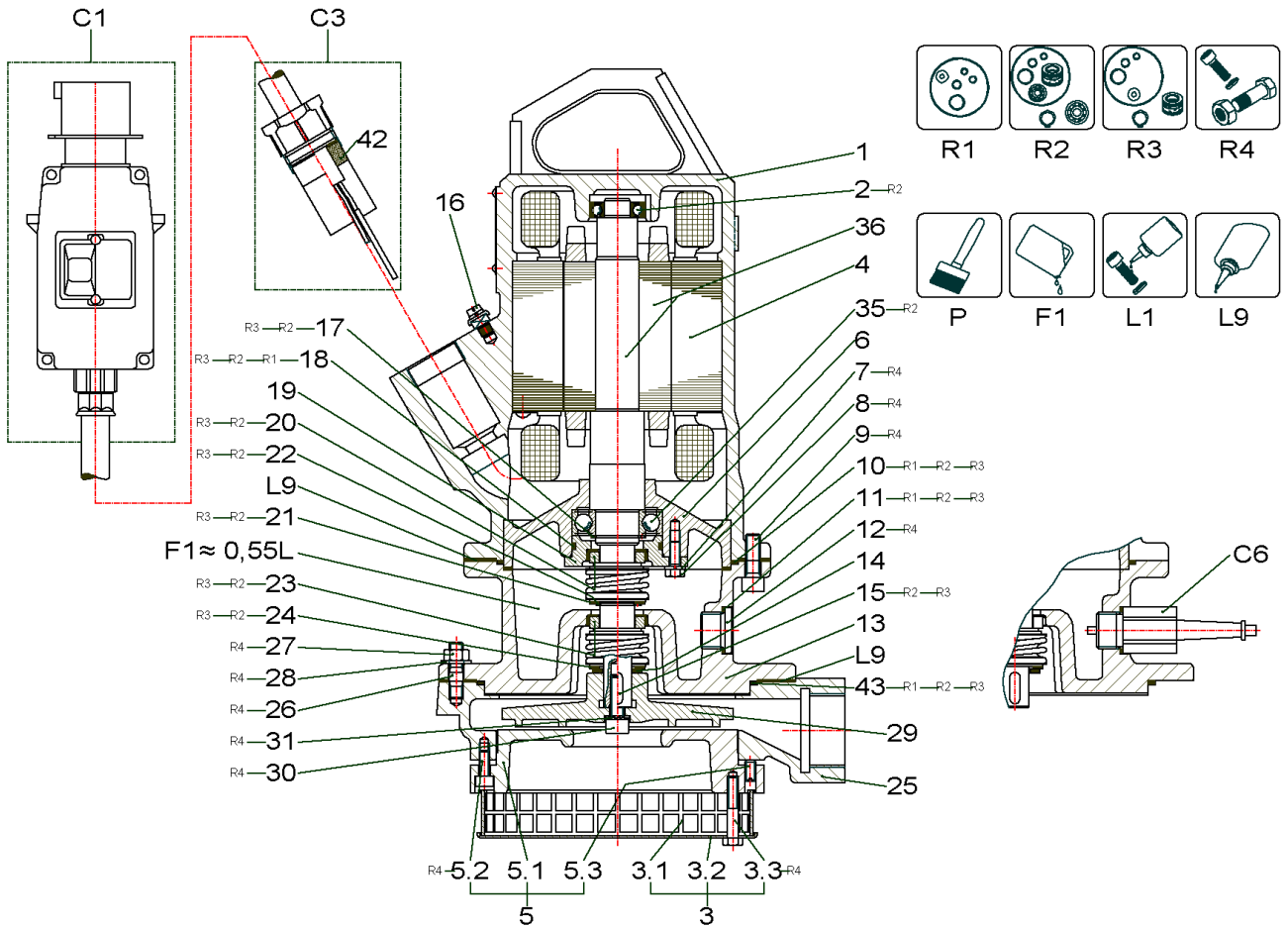

CONTRACTOR'S PUMP KS6 (Bm4) UNIT

Item	Article no.	Description	Quantity
R1	6016204	Rep.Kit 1 T12K, T12G BM2 / BM3 Vit	1
R2	6016074	Rep.Kit 2 T12K;T12G Bm2/Bm3 Vit	1
R3	6016073	Rep.Kit 3 T12K;T12G Bm2/Bm3 Vit	1
R4	6042219	Screws KS5,6,16/T12 KIT	1
P	6042254	PAINT SPRAY Pantone334	1
P	6042255	colour 2K-paint IV80 pantone334C 250ml	1
P	6023614	Ceram C0 black 100 ml KIT	1
P	6020579	Ceram C0 black 250 ml KIT	1
P	6023485	Ceram C0 Black 500ml Kit	1
P	6019157	Ceram C0 black 1000 ml KIT	1
F1	6025460	medical white oil 1L KIT	1
L1	6080531	Loctite 243 5g flask VP:	1
L1	2096167	Loctite 243 50ml VP.	1
L9	6080535	Loctite 5203 300ml VP.	1

C1		PLUG	1
C3		cablE trumpet 30T KIT	1
C6		electrode KIT	1

1	6013993	motor casing 50.18026/1 GG	1
2	6086141	ball bearing 6002 VP.	1
36	6010586	rotor D.61,4x265 2/6 1.4021	1
4	6023501	stator T12-2/6 400 50Hz VN01	1
		alternativ / alternative / alternative	
4	6023502	stator T12-2/6 500 50Hz VN01	1
35	2046946	ball bearing 6205/2RS-C3 (HT) VP.	1
6	6085141	bearing housing 53.17238 GG VP.	1
7		lock washer 6 DIN7980 A4	3
8		screw M6x16 DIN933 A2-70 (10pc)	1
9		screw M8x25 DIN912 A4 (10pc)	1
10		o-ring ID.125,0x3,0 Viton	1
11	6048832	joint ring A21/26x1,5 DIN7603 PA(10pc)	1
12	6067638	screw plug G1/2 DIN908 A4 (3pcs)	1
13	6047095	sealing casing D.152g6 52.20035 GG	1

CONTRACTOR'S PUMP KS6 (Bm4) UNIT

Item	Article no.	Description	Quantity
14	6002118	washer 17 DIN433 A2	1
15	6004654	key A 6x4x18 54.2589 A4	1
16	6067407	Barlian bow terminal M5 A2	1
17	6002002	circlips 25x1,2 DIN471 FSt	1
18		-ring ID.44,0x3,0 Viton 75	1
19	6085142	bearing cover D.35H7 53.17239 GG VP.	1
20	6074596	mechanical shaft seal MG1/20-G64 Q1Q1VGG	1
21	6005374	pressure ring 31,6x1 1.4571	1
22	6002006	circlips 20x1,2 DIN471 1.4116	1
23	6074596	mechanical shaft seal MG1/20-G64 Q1Q1VGG	1
24	6005374	pressure ring 31,6x1 1.4571	1
25	6044536	pump housing QG1 1/4 52.18392/1 GG	1
		alternativ / alternative / alternative	
25	6044731	pump housing QG1 1/4 52.18392/1 GG/C0	1
26		screw M8x22 DIN939 A2-70	3
27		nut M8 DIN934 A2-80	3
28		washer A8,4 DIN125 1.4401 (20pc)	1
29	6014155	impeller-W D.132 54.18383 GG	1
		alternativ / alternative / alternative	
29	6021746	impeller-W D.132 54.18383 GG/C0	1
30	6003416	screw M8x25 DIN912 10.9 Geomet	1
31	6002688	screw locking Nord-Lock 13,5/8,7 A4	1
5	6072179	suction port KS5/6 M03-12 53.14379 GG KI	1
5.1		> suction port 53.14379 GG	1
5.2		> screw M6x16 ISO4762 A4	3
5.3		> Stud bolt M8x12 DIN915 A4	3
		alternativ / alternative / alternative	
5.1	6012770	suction port 53.14379 GG/C0	1
3	6072178	strainer KS5/6 M03-12 1.4301 KIT	1
3.1		> strainer 26x155x2 1.4301	1
3.2		> base plate D.160x3 1,5 1.4301	1
3.3		> screw M6x35 ISO4014 A4-70	3
		alternativ / alternative / alternative	
3.1	6013182	strainer 26x155x2 54.10534/1 1.4301 C0	1

CONTRACTOR'S PUMP KS6 (Bm4) UNIT

Item	Article no.	Description	Quantity
3.2	6017621	base plate D.160x3 53.10536/1 1.4301/C0	1
42	6076649	seal ring D.29,5/16x16,5 54.17777NBR VP.	1
42	6076650	seal ring D.29,5/17x16,5 54.17777 NBR VP	1
42	6076651	seal ring D.29,5/19x16,5 54.17777NBR VP.	1
		alternativ / alternative / alternative	
42	6037031	seal ring D.29,5/16x16,5 CR silicon free	1
42	6037478	seal ring D.29,5/19x16,5 CR silicon free	1
43	6007641	o-ring ID.150,0x3,0 Viton	1

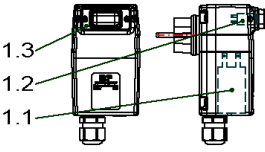
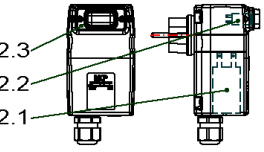
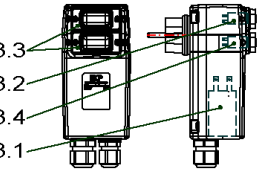
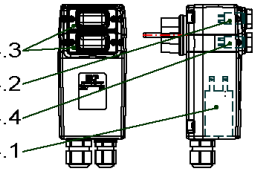
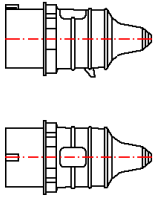
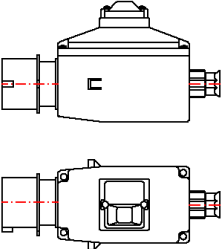
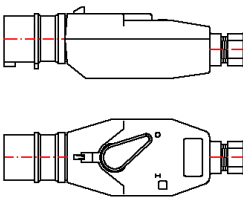
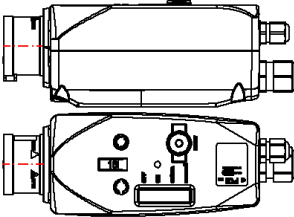
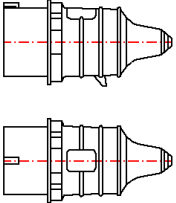
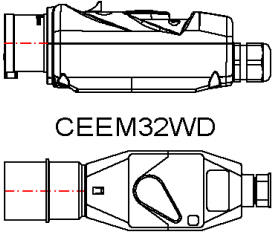
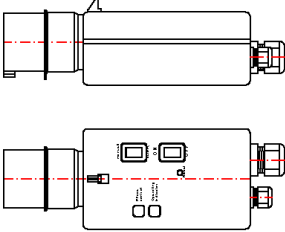
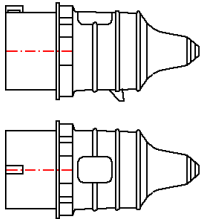
<p>1 MCP 6A-M-H-20μF ~ 230V</p>  <p>$I_N(230V / 50Hz) < 6A = 20\mu F$</p>	<p>2 MCP 10A-M-H-30μF ~ 230V</p>  <p>$I_N(230V / 50Hz) 6-10A = 30\mu F$</p>	<p>3 MCP 6A-M-HA-20μF ~ 230V</p>  <p>$I_N(230V / 50Hz) < 6A = 20\mu F$</p>	<p>4 MCP 10A-M-HA-30μF ~ 230V</p>  <p>$I_N(230V / 50Hz) 6-10A = 30\mu F$</p>
<p>5 CEE16A</p> 	<p>6 CEEM16W</p> 	<p>7 CEEM16WD</p> 	<p>8 MCP T4-HA-ROT-WSK CEE16-5PS</p> 
<p>9 CEE32A</p> 	<p>10 MCP 10-16A-T4-H-ROT CEE32-5PS</p>  <p>CEEM32WD</p>	<p>11 CEEM32WDSHA</p> 	<p>12 CEE63A</p> 

PLUG

Item	Article no.	Description	Quantity
		IN (230V / 50Hz) <6A - 20µF	
1	6072332	MCP 6A-M-H-20µF-CEE7/7 VP.	1
1.1	6071702	capacitor 400V 20µF MCP VP.	1
1.2	6071704	protection switch 6A MCP VP.	1
1.3	6071707	protecting cap MCP VP.	1
		IN (230V / 50Hz) 6-10A - 30µF	
2	6072330	MCP 10A-M-H-30µF-CEE7/7 VP.	1
2.1	6071703	capacitor 400V 30µF MCP VP.	1
2.2	6071705	protection switch 10A MCP VP.	1
2.3	6071707	protecting cap MCP VP.	1
		IN (230V / 50Hz) <6A - 20µF	
3	6072331	MCP 6A-M-HA-20µF-CEE7/7 VP.	1
3.1	6071702	capacitor 400V 20µF MCP VP.	1
3.2	6071704	protection switch 6A MCP VP.	1
3.3	6071707	protecting cap MCP VP.	2
3.4	6071706	switch on/out MCP VP.	1
		IN (230V / 50Hz) 6-10A - 30µF	
4	6072329	MCP 10A-M-HA-30µF-CEE7/7 VP	1
4.1	6071703	capacitor 400V 30µF MCP VP.	1
4.2	6071705	protection switch 10A MCP VP.	1
4.3	6071707	protecting cap MCP VP.	2
4.4	6071706	switch on/out MCP VP.	1
5	6003000	plug CEE16A/400V 60Hz/5P-11h	1
5	6003248	plug CEE16A/400V/4P-6H	1
5	6003009	plug CEE16A/400V/5P-6H	1
5	6039156	plug CEE16A/400V/5P-6H Phase inverter	1
5	6035231	plug CEE16A/400V/7P-6H	1
5	6003011	plug CEE16A/500V/5P-7H	1
6	6030883	plug MS400V5P CEE16A W 1,0-1,6A	1
6	6030884	plug MS400V5P CEE16A W 1,6-2,5A	1
6	6030888	plug MS400V5P CEE16A W 10,0-16,0A	1
6	6030885	plug MS400V5P CEE16A W 2,5-4,0A	1
6	6030886	plug MS400V5P CEE16A W 4,0-6,3A	1
6	6030887	plug MS400V5P CEE16A W 6,3-10,0A	1

PLUG

Item	Article no.	Description	Quantity
7	6032446	plug MS400V4P CEE16A WD 1,6-2,5A	1
7	6032447	plug MS400V4P CEE16A WD 12,5-16,0A	1
7	6032295	plug MS400V4P CEE16A WD 2,5-4,0A	1
7	6032289	plug MS400V4P CEE16A WD 4,0-6,3A	1
7	6032292	plug MS400V4P CEE16A WD 6,3-9,0A	1
7	6042190	plug MS400V5P CEE16A WDII 1,6-2,5A	1
7	6042194	plug MS400V5P CEE16A WDII 10,0-16,0A	1
7	6042191	plug MS400V5P CEE16A WDII 2,5-4,0A	1
7	6042192	plug MS400V5P CEE16A WDII 4,0-6,3A	1
7	6042193	plug MS400V5P CEE16A WDII 6,3-10,0A	1
7	6035911	plug MS400V5P CEE16A WD 9,0-12,5A	1
7	6003337	plug MS500V5P CEE16A WD 1,6-2,5A	1
7	6003336	plug MS500V5P CEE16A WD 2,5-4,0A	1
7	6003335	plug MS500V5P CEE16A WD 4,0-6,3A	1
7	6003334	plug MS500V5P CEE16A WD 6,3-9,0A	1
8	6072520	MCP 1,0-1,6A-T4-HA-ROT-WSK-CEE16-5PS VP.	1
8	6072521	MCP 1,6-2,4A-T4-HA-ROT-WSK-CEE16-5PS VP.	1
8	6072522	MCP 2,4-4,0A-T4-HA-ROT-WSK-CEE16-5PS VP.	1
8	6072523	MCP 4,0-6,0A-T4-HA-ROT-WSK-CEE16-5PS VP.	1
8	6072524	MCP 6,0-10A-T4-HA-ROT-WSK-CEE16-5PS VP.	1
8	6072525	MCP 9,0-12A-T4-HA-ROT-WSK-CEE16-5PS VP.	1
8	6072526	MCP 12-16A-T4-HA-ROT-WSK-CEE16-5PS VP.	1
9	6003267	plug CEE32A/400V/4P-6H	1
9	6039155	plug CEE32A/400V/5P-6H Phase inverter	1
9	6035895	plug CEE32A/500V/4P-7H AM-Top	1
9	6003010	plug CEE32A/500V/5P-7H	1
10	6072370	MCP 400V 1,6-2,5A-T4-H-ROT-CEE32-5PS VP.	1
10	6072369	MCP 400V 2,5-4,0A-T4-H-ROT-CEE32-5PS VP.	1
10	6072371	MCP 400V 4,0-6,3A-T4-H-ROT-CEE32-5PS VP.	1
10	6072398	MCP 400V 6,3-10A-T4-H-ROT-CEE32-5PS VP.	1
10	6072519	MCP 400V 10-16A-T4-H-ROT-CEE32-5PS VP.	1
10	6072399	MCP 400V 16-20A-T4-H-ROT-CEE32-5PS VP.	1
10	6072518	MCP 400V 20-25A-T4-H-ROT-CEE32-5PS VP.	1
10	6037649	plug.MS500V4P CEE32A WD 2,5-4,0A	1

PLUG

Item	Article no.	Description	Quantity
10	6041268	plug MS500V4P CEE32A WD 4,0-6,3A	1
10	6035244	plug MS500V5P CEE32A WD 1,6-2,5A	1
10	6034700	plug MS500V5P CEE32A WD 2,5-4,0A	1
10	6041556	plug MS500V5P CEE32A WD 4,0-6,3A	1
10	6002701	plug MS500V5P CEE32A WD 9,0-12,5A	1
10	6002700	plug MS500V5P CEE32A WD 12,5-16,0A	1
11	6003241	plug MS400V5P CEE32A WDSHA 10,0-14,0A	1
11	6003266	plug MS400V5P CEE32A WDSHA 3,7-5,5A	1
11	6003265	plug MS400V5P CEE32A WDSHA 5,5-8,0A	1
11	6003264	plug MS400V5P CEE32A WDSHA 8,0-11,5A	1
12	6003012	plug CEE63A/400V/5P-6H/IP67	1

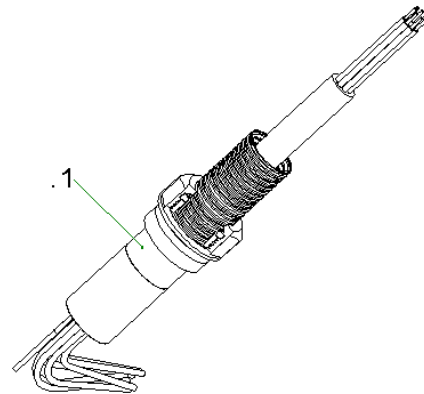
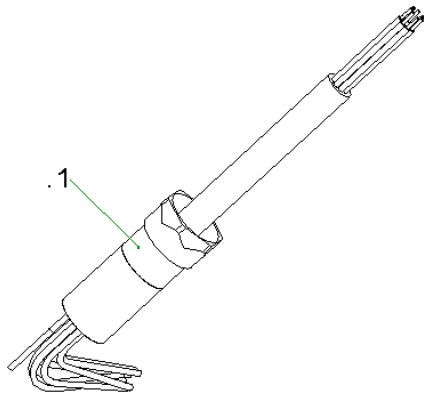

- 1 H07RN-F
- 2 NSSHOEU-J
- 3 SOOW

- 4 H07RN-F
- 5 NSSHOEU-J

cable trumpet 30T KIT

Item	Article no.	Description	Quantity
.1	6076649	seal ring D.29,5/16x16,5 54.17777NBR VP.	1
.1	6076650	seal ring D.29,5/17x16,5 54.17777 NBR VP	1
.1	6076651	seal ring D.29,5/19x16,5 54.17777NBR VP.	1
		alternativ / alternative / alternative	
.1	6037031	seal ring D.29,5/16x16,5 CR silicon free	1
.1	6037478	seal ring D.29,5/19x16,5 CR silicon free	1
1	6022379	cable trumpet 30T 5m H07 7G1,5 KIT	1
1	6019236	cable trumpet 30T 10m H07 7G1,5 KIT	1
1	6035928	cable trumpet 30T 15m H07 7G1,5 KIT	1
1	6060476	cable trumpet 30T 20m H07 7G1,5 KIT	1
1	6019164	cable trumpet 30T 25m H07 7G1,5 KIT	1
1	6060477	cable trumpet 30T 30m H07 7G1,5 KIT	1
1	6048268	cable trumpet 30T 35m H07 7G1,5 KIT	1
1	6060475	cable trumpet 30T 50m H07 7G1,5 KIT	1
1	6087356	cable trumpet 30T 10m H07 10G1,5 KIT	1
1	6041748	cable trumpet30T 15m H07 10G1,5 KIT	1
1	6080969	cable trumpet30T 20m H07 10G1,5 KIT	1
2	6031795	cable trumpet 30T 15m NSS 4x1,5 KIT	1
2	6040015	cable trumpet 30T 20m NSS 4x1,5 KIT	1
2	6035322	cable trumpet 30T 10m NSS 7x1,5 KIT	1
2	6028732	cable trumpet 30T 20m NSS 7x1,5 KIT	1
2	6026657	cable trumpet 30T 25m NSS 7x,1,5 KIT	1
2	6030434	cable trumpet 30T 15m NSS 7x2,5 KIT	1
3	6068166	cable trumpet 30T 10m 7* AWG 14 KIT	1
4	6042225	cable trumpet 30T 10m H07 7G1,5 C KIT	1
5	6042226	cable trumpet 30T 10m NSS 7x1,5 C KIT	1
5	6063462	cable trumpet 30T 15m NSS 7x1,5 C KIT	1
5	6063021	cable trumpet 30T 20m NSS 7x,1,5 C KIT	1

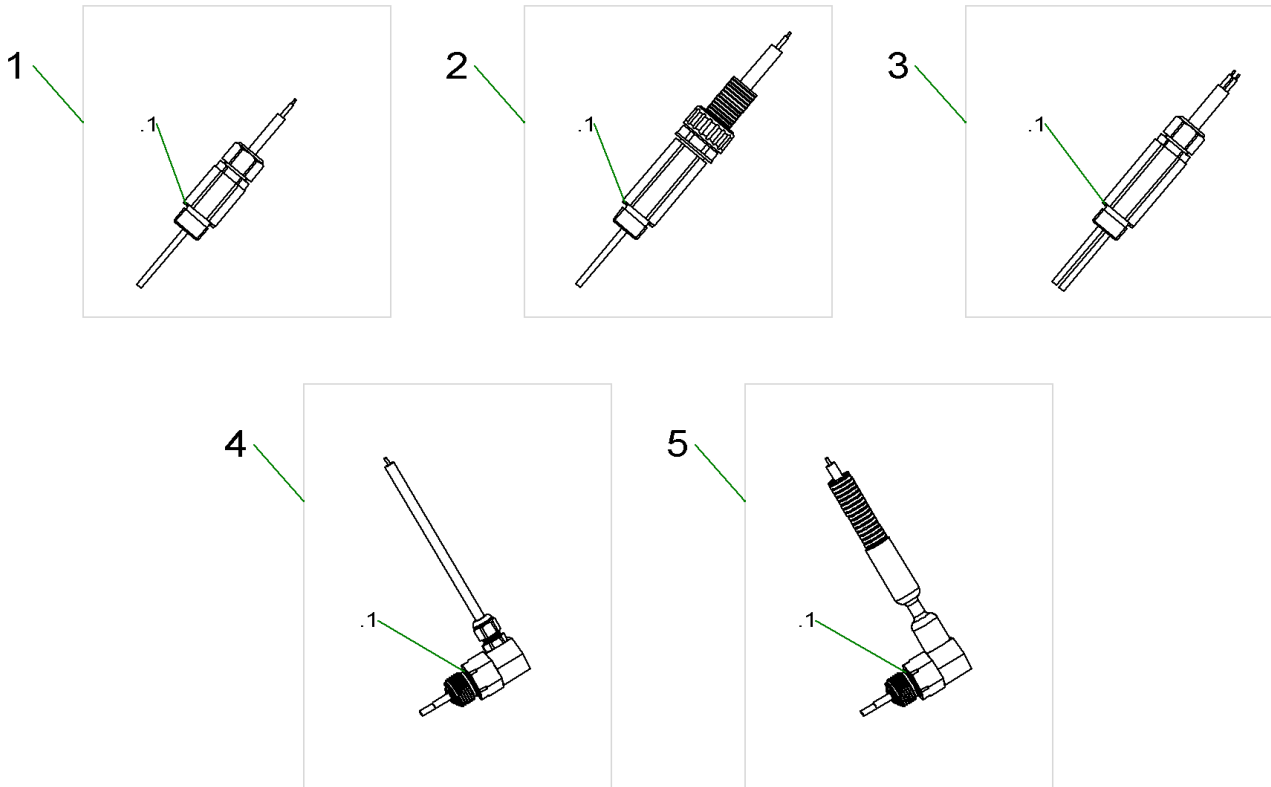

electrode KIT

Item	Article no.	Description	Quantity
.1	6048832	joint ring A21/26x1,5 DIN7603 PA(10pc)	1
1	6042222	pencil electrode G1/2 10m KIT	1
1	6042313	pencil electrode G1/2 15m KIT	1
1	6042223	pencil electrode G1/2 20m KIT	1
1	6061068	pencil electrode G1/2 25KIT	1
1	6061070	pencil electrode G1/2 30m KIT	1
1	6061069	Stabelektrode G1/2 40m SET	1
1	6060956	pencil electrode G1/2 55m KIT	1
2	6042227	pencil electrode G1/2 10m+hose KIT	1
2	6065196	pencil electrode G1/2 15m+hose KIT	1
3	6042229	double pencil electrode G1/2 10m KIT	1
3	6042228	double pencil electrode G1/2 20m KIT	1
3	6063536	double pencil electrode G1/2 40m KIT	1
3	6065157	double pencil electrode G1/2 10m 4*A KIT	1
3	6065156	double pencil electrode G1/2 20m 4*AWKIT	1
4	6068049	elbow pencil electrode G1/2 10m SET	1
4	6068050	elbow pencil electrode G1/2 15m SET	1
4	6075169	elbow pencil electrode G1/2 20m SET	1
5	6068345	elbow pencil electrode G1/2 10m+Schl. KI	1
5	6068346	elbow pencil electrode G1/2 15m+Schl. SE	1

CONTRACTOR'S PUMP KS8 UNIT (6000112)

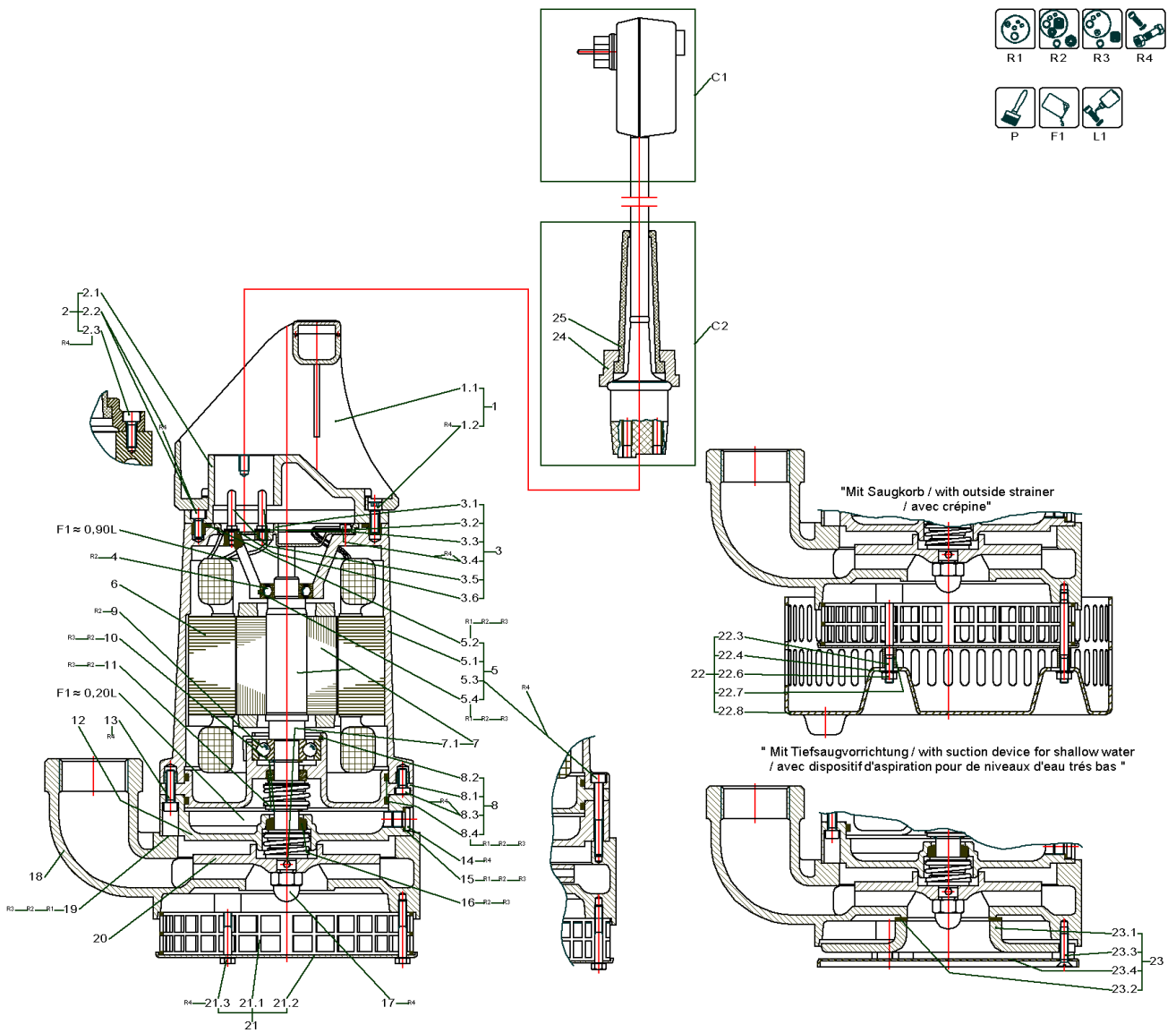

CONTRACTOR'S PUMP KS8 UNIT (6000112)

Item	Article no.	Description	Quantity
R1	6016267	Rep.Kit 1 KS8,9,12,14,15, F12 Vit	1
R2	6016308	Rep.Kit 2 KS8,9,12,14,15	1
R3	6016307	Rep.Kit 3 KS8,9,12,14,15	1
R4	6016132	Screws KS8,9,12,14,15 KE7;8;9, F12 KIT	1
P	6042254	PAINT SPRAY Pantone334	1
P	6042255	colour 2K-paint IV80 pantone334C 250ml	1
P	6023614	Ceram C0 black 100 ml KIT	1
P	6020579	Ceram C0 black 250 ml KIT	1
P	6023485	Ceram C0 Black 500ml Kit	1
P	6019157	Ceram C0 black 1000 ml KIT	1
F1	6025460	medical white oil 1L KIT	1
F1	6025461	medical white oil 5L KIT	1
L1	6080531	Loctite 243 5g flask VP:	1
L1	2096167	Loctite 243 50ml VP.	1

C1		PLUG	1
C2		cable for motor F12 / F13	1

1	6019566	handle 51.15480/1 plastics KIT	1
1.2		> screw M5x16 ISO4762 A2-70	1
1.1		> handle 51.15480/1 Akulon	1
2	6022949	motor cover D.95,8 51.17219 GG KIT	1
2.1		> motor cover D.95,8 51.17219 GG	1
2.2		> SCREW M5X12 ISO4762 A2-70	3
2.3		> screw M6x16 DIN912 A4 (10pc)	1
3	6001273	terminal board 54.3453 Makrolon KIT	1
3.1		> terminal board plastics Polycarbonat	1
3.5		> contact pin Ms	4
3.2		> lock washer 4 DIN7980 A4	1
3.3		> washer A4,3 DIN125 Ms	5
3.4		> screw M4x8 DIN84 Ms	1
3.6		> washer 4,3 DIN7349 Ms	1
4	6086141	ball bearing 6002 VP.	1
5	6021772	motor casing 52.3441 Al KIT	1

CONTRACTOR'S PUMP KS8 UNIT (6000112)

Item	Article no.	Description	Quantity
5.1		> motor casing 52.3441 Al	1
5.2		> o-ring ID.92,0x3,0 Viton	1
5.3		> screw M5x25 DIN912 A2-70	3
Note: für / for / pour KE			
5.3		> screw M5x45 ISO4762 A2-70	3
Note: für / for / pour KS			
5.4		> o-ring ID.32x1,78 Viton	1
Stator / stator / stator 50 Hz			
6	6023535	stator F12-2/6 230E 50Hz Ser11	1
6	6023532	stator F12-2/6 400 50Hz VN 01	1
6	6023533	stator F12-2/6 415 50Hz VN 01	1
6	6023534	stator F12-2/6 500 50Hz VN 01	1
alternativ / alternative / alternative			
6	6023531	stator F12-2/6 230 50Hz	1
Stator / stator / stator 60 Hz			
6	6023536	stator F12-2/6 230E 60Hz Ser11	1
6	6023537	stator F12-2/6 230/400 60Hz	1
7	6010006	rotor D.61,4x189 2/6 1.4021	1
8	6042497	bearing housing U 6050660 GG KIT	1
8.1		> lower bearing D.42H7 6050660 GG	1
8.2	6004669	> circlips 43,6x1,8 54.3438 FSt	1
8.3		> screw M5x12 DIN6912 A2-70	3
8.4		> o-ring ID.115,0x3,0 Viton -	2
9	6008975	ball bearing 6302	1
10	6002007	circlips 15x1 DIN471 FSt	2
11	6075396	mech shaft seal MG1/15-G64 BXPGG VP.	1
12	6013732	sealing casing D.125f6 53.3452 GG	1
alternativ / alternative / alternative			
12	6013724	sealing casing D.125f6 53.3452 GG/C0	1
12	6013730	sealing casing D.125f6 53.3452 GG/C1	1
13		screw M5x20 ISO4762 A2	3
14	6002430	screw plug G1/8 DIN908 A2	1
15	6048829	joint ring A10/13,5x1,5 DIN7603 PA(10pc)	1
16	6075381	mechanical shaft seal MG1/15-G4 Q1Q1PGG	1

CONTRACTOR'S PUMP KS8 UNIT (6000112)

Item	Article no.	Description	Quantity
		alternativ / alternative / alternative	
16	6003878	mechanical shaft seal MG1/15-G4 Q1Q1VGG	1
17	6002104	domet nut M10 DIN1587 A2	1
18	6012850	pump housing A G11/4 52.10520/2 GG	1
		alternativ / alternative / alternative	
18	6012848	pump hou. AG1 1/4 GG/C0 52.19207	1
18	6024442	pump housing A G11/4 52.19189 Abrasit	1
18	6022781	pump housing A G11/4 52.19189 Abrasit/C0	1
18	6012903	pump housing AG1 1/4 1.4581 52.16782VN00	1
19	6048831	flat gasket D.125/155 ARAMID/NBR (10pc)	1
		Laufrad / Impeller / Roue 50Hz	
20	6014013	impeller-W D.114 54.2392/1 GG	1
		alternativ / alternative / alternative	
20	6014005	impeller-W D.114 54.2392/1 GG/C0	1
20	6010632	impeller-W D.114 54.17902 Abrasit	1
20	6022790	impeller-W D.114 54.17902 Abrasit/C0	1
20	6014011	impeller-W D.114 54.2392/1 1.4581	1
		Laufrad / Impeller / Roue 60Hz	
20	6014009	impeller-W D.97 54.2114/1 GG	1
		alternativ / alternative / alternative	
20	6021758	Impeller-W D.97 54.2114/1 GG/C0	1
20	6022788	impeller-W D.97 54.17902 Abrasit	1
20	6022789	impeller-W D.97 54.17902 Abrasit/C0	1
20	6021647	impeller-W D.97 54.2114/1 1.4581	1
21	6001147	strainer 54.10534/1 1.4301 KIT	1
21.1		> strainer 26x155x2 1.4301	1
21.2		> base plate D.160x3 1,5 1.4301	1
21.3		> screw M5x35 ISO4014 A2-70	3
22	6032617	add on strainer KS 8/9 KIT	1
23	6021392	suction plate 53.17572 GG KIT	1
23.1		> suction plate 53.17572 GG	1
23.2	6004149	> flat gasket D.50/65x2 NBR	1
23.3	6002405	> screw M5x20 DIN963 A4	3
23.4		> base plate D.160x3 1,5 1.4301	1

CONTRACTOR'S PUMP KS8 UNIT (6000112)

Item	Article no.	Description	Quantity
24	6004828	cable gland Akulon	1
25	6003824	cable peotection NBR 87x30 mm	1

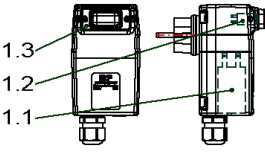
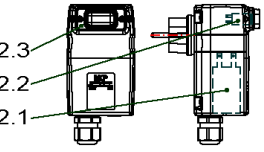
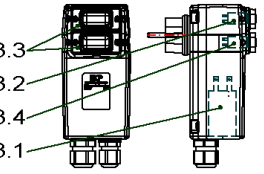
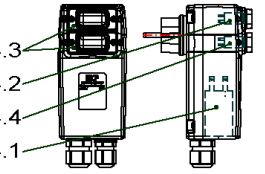
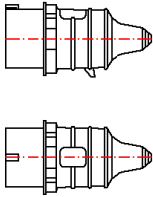
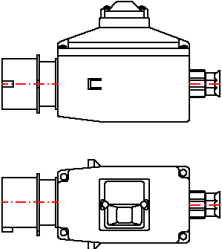
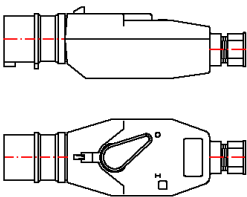
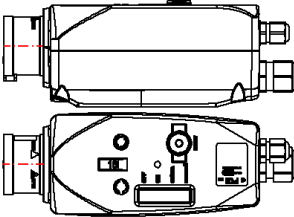
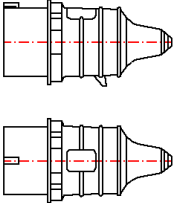
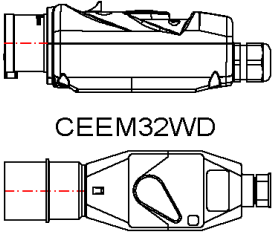
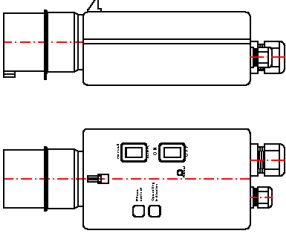
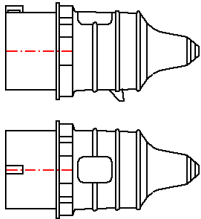
<p>1 MCP 6A-M-H-20μF ~ 230V</p>  <p>$I_N(230V / 50Hz) < 6A = 20\mu F$</p>	<p>2 MCP 10A-M-H-30μF ~ 230V</p>  <p>$I_N(230V / 50Hz) 6-10A = 30\mu F$</p>	<p>3 MCP 6A-M-HA-20μF ~ 230V</p>  <p>$I_N(230V / 50Hz) < 6A = 20\mu F$</p>	<p>4 MCP 10A-M-HA-30μF ~ 230V</p>  <p>$I_N(230V / 50Hz) 6-10A = 30\mu F$</p>
<p>5 CEE16A</p> 	<p>6 CEEM16W</p> 	<p>7 CEEM16WD</p> 	<p>8 MCP T4-HA-ROT-WSK CEE16-5PS</p> 
<p>9 CEE32A</p> 	<p>10 MCP 10-16A-T4-H-ROT CEE32-5PS</p>  <p>CEEM32WD</p>	<p>11 CEEM32WDSHA</p> 	<p>12 CEE63A</p> 

PLUG

Item	Article no.	Description	Quantity
		IN (230V / 50Hz) <6A - 20μF	
1	6072332	MCP 6A-M-H-20μF-CEE7/7 VP.	1
1.1	6071702	capacitor 400V 20μF MCP VP.	1
1.2	6071704	protection switch 6A MCP VP.	1
1.3	6071707	protecting cap MCP VP.	1
		IN (230V / 50Hz) 6-10A - 30μF	
2	6072330	MCP 10A-M-H-30μF-CEE7/7 VP.	1
2.1	6071703	capacitor 400V 30μF MCP VP.	1
2.2	6071705	protection switch 10A MCP VP.	1
2.3	6071707	protecting cap MCP VP.	1
		IN (230V / 50Hz) <6A - 20μF	
3	6072331	MCP 6A-M-HA-20μF-CEE7/7 VP.	1
3.1	6071702	capacitor 400V 20μF MCP VP.	1
3.2	6071704	protection switch 6A MCP VP.	1
3.3	6071707	protecting cap MCP VP.	2
3.4	6071706	switch on/out MCP VP.	1
		IN (230V / 50Hz) 6-10A - 30μF	
4	6072329	MCP 10A-M-HA-30μF-CEE7/7 VP	1
4.1	6071703	capacitor 400V 30μF MCP VP.	1
4.2	6071705	protection switch 10A MCP VP.	1
4.3	6071707	protecting cap MCP VP.	2
4.4	6071706	switch on/out MCP VP.	1
5	6003000	plug CEE16A/400V 60Hz/5P-11h	1
5	6003248	plug CEE16A/400V/4P-6H	1
5	6003009	plug CEE16A/400V/5P-6H	1
5	6039156	plug CEE16A/400V/5P-6H Phase inverter	1
5	6035231	plug CEE16A/400V/7P-6H	1
5	6003011	plug CEE16A/500V/5P-7H	1
6	6030883	plug MS400V5P CEE16A W 1,0-1,6A	1
6	6030884	plug MS400V5P CEE16A W 1,6-2,5A	1
6	6030888	plug MS400V5P CEE16A W 10,0-16,0A	1
6	6030885	plug MS400V5P CEE16A W 2,5-4,0A	1
6	6030886	plug MS400V5P CEE16A W 4,0-6,3A	1
6	6030887	plug MS400V5P CEE16A W 6,3-10,0A	1

PLUG

Item	Article no.	Description	Quantity
7	6032446	plug MS400V4P CEE16A WD 1,6-2,5A	1
7	6032447	plug MS400V4P CEE16A WD 12,5-16,0A	1
7	6032295	plug MS400V4P CEE16A WD 2,5-4,0A	1
7	6032289	plug MS400V4P CEE16A WD 4,0-6,3A	1
7	6032292	plug MS400V4P CEE16A WD 6,3-9,0A	1
7	6042190	plug MS400V5P CEE16A WDII 1,6-2,5A	1
7	6042194	plug MS400V5P CEE16A WDII 10,0-16,0A	1
7	6042191	plug MS400V5P CEE16A WDII 2,5-4,0A	1
7	6042192	plug MS400V5P CEE16A WDII 4,0-6,3A	1
7	6042193	plug MS400V5P CEE16A WDII 6,3-10,0A	1
7	6035911	plug MS400V5P CEE16A WD 9,0-12,5A	1
7	6003337	plug MS500V5P CEE16A WD 1,6-2,5A	1
7	6003336	plug MS500V5P CEE16A WD 2,5-4,0A	1
7	6003335	plug MS500V5P CEE16A WD 4,0-6,3A	1
7	6003334	plug MS500V5P CEE16A WD 6,3-9,0A	1
8	6072520	MCP 1,0-1,6A-T4-HA-ROT-WSK-CEE16-5PS VP.	1
8	6072521	MCP 1,6-2,4A-T4-HA-ROT-WSK-CEE16-5PS VP.	1
8	6072522	MCP 2,4-4,0A-T4-HA-ROT-WSK-CEE16-5PS VP.	1
8	6072523	MCP 4,0-6,0A-T4-HA-ROT-WSK-CEE16-5PS VP.	1
8	6072524	MCP 6,0-10A-T4-HA-ROT-WSK-CEE16-5PS VP.	1
8	6072525	MCP 9,0-12A-T4-HA-ROT-WSK-CEE16-5PS VP.	1
8	6072526	MCP 12-16A-T4-HA-ROT-WSK-CEE16-5PS VP.	1
9	6003267	plug CEE32A/400V/4P-6H	1
9	6039155	plug CEE32A/400V/5P-6H Phase inverter	1
9	6035895	plug CEE32A/500V/4P-7H AM-Top	1
9	6003010	plug CEE32A/500V/5P-7H	1
10	6072370	MCP 400V 1,6-2,5A-T4-H-ROT-CEE32-5PS VP.	1
10	6072369	MCP 400V 2,5-4,0A-T4-H-ROT-CEE32-5PS VP.	1
10	6072371	MCP 400V 4,0-6,3A-T4-H-ROT-CEE32-5PS VP.	1
10	6072398	MCP 400V 6,3-10A-T4-H-ROT-CEE32-5PS VP.	1
10	6072519	MCP 400V 10-16A-T4-H-ROT-CEE32-5PS VP.	1
10	6072399	MCP 400V 16-20A-T4-H-ROT-CEE32-5PS VP.	1
10	6072518	MCP 400V 20-25A-T4-H-ROT-CEE32-5PS VP.	1
10	6037649	plug.MS500V4P CEE32A WD 2,5-4,0A	1

PLUG

Item	Article no.	Description	Quantity
10	6041268	plug MS500V4P CEE32A WD 4,0-6,3A	1
10	6035244	plug MS500V5P CEE32A WD 1,6-2,5A	1
10	6034700	plug MS500V5P CEE32A WD 2,5-4,0A	1
10	6041556	plug MS500V5P CEE32A WD 4,0-6,3A	1
10	6002701	plug MS500V5P CEE32A WD 9,0-12,5A	1
10	6002700	plug MS500V5P CEE32A WD 12,5-16,0A	1
11	6003241	plug MS400V5P CEE32A WDSHA 10,0-14,0A	1
11	6003266	plug MS400V5P CEE32A WDSHA 3,7-5,5A	1
11	6003265	plug MS400V5P CEE32A WDSHA 5,5-8,0A	1
11	6003264	plug MS400V5P CEE32A WDSHA 8,0-11,5A	1
12	6003012	plug CEE63A/400V/5P-6H/IP67	1

cable for motor F12 / F13

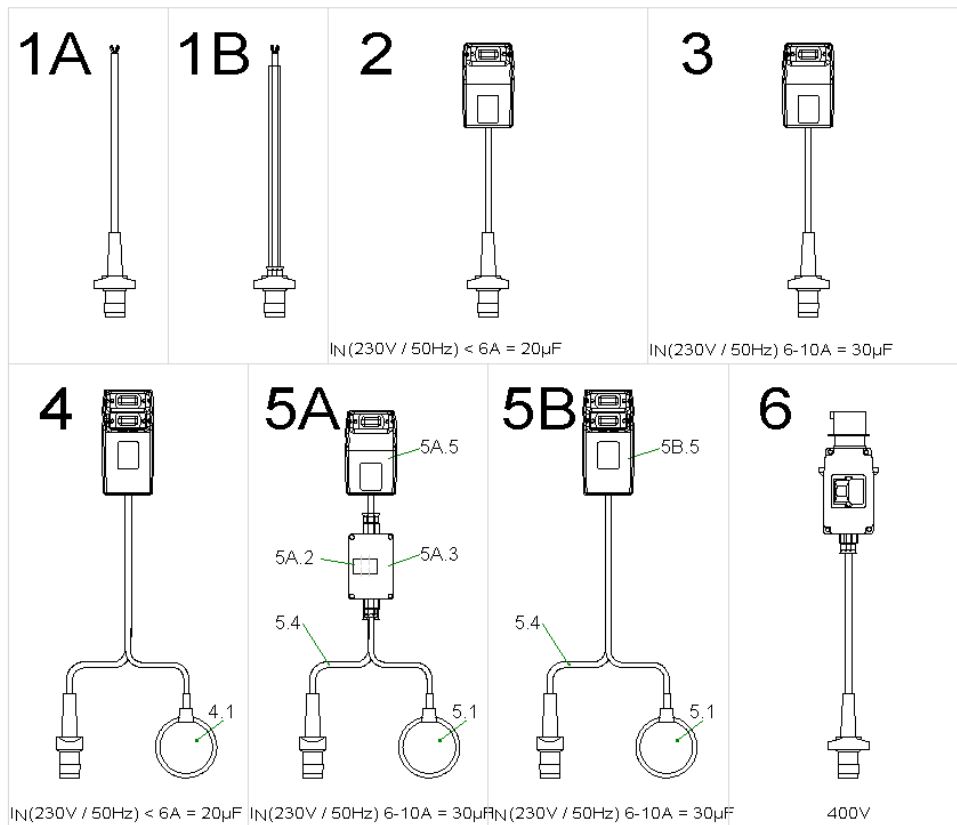

cable for motor F12 / F13

Item	Article no.	Description	Quantity
1A	6072559	cable 5m H07 4G1,5/coupling VP.	1
1A	6072560	cable 10m H07 4G1,5/coupling VP.	1
1A	6072561	cable 20m H07 4G1,5/coupling VP.	1
1A	6072562	cable 30m H07 4G1,5/coupling VP.	1
1A	6072563	cable 40m H07 4G1,5/coupling VP.	1
1A	6087533	cable 40m H07 4G1,5/coupling VP.	1
1B	6072564	cable 10m H07 4G1,5/coupl./hose VP. IN (230V / 50Hz) <6A - 20μF	1
2	6072565	switch box MCP 6A H 5M VP.	1
2	6072566	switch box MCP 6A H 10M VP.	1
2	6072567	switch box MCP 6A H 20M VP. IN (230V / 50Hz) 6-10A - 30μF	1
3	6072568	switch box MCP 10A H 5M VP.	1
3	6072569	switch box MCP 10A H 10M VP.	1
3	6072570	switch box MCP 10A H 20M VP. IN (230V / 50Hz) <6A - 20μF	1
4	6072571	switch box MCP 6A HA 5M VP.	1
4	6072572	switch box MCP 6A HA 10M VP.	1
4.1	6072582	float switch S-PS 10A 250V 10m NO VP	1
4	6072576	switch box MCP 6A HA 20M VP.	1
4.1	6072583	float switch S-PS 10A 250V 20m NO VP IN (230V / 50Hz) 6-10A - 30μF	1
5A		on request	1
5B	6072577	switch box MCP 10A HA 10M	1
5.1	6072582	float switch S-PS 10A 250V 10m NO VP	1
5A.2	6003341	contactor 5,5 kW 230 V, 50 Hz	1
5A.3	6031509	blank casing KS12/15ES KIT	1
5.4	6072560	cable 10m H07 4G1,5/coupling VP.	1
5A.5	6072330	MCP 10A-M-H-30μF-CEE7/7 VP.	1
5B.5	6072329	MCP 10A-M-HA-30μF-CEE7/7 VP für / for / pour 400V	1
6	6023991	switch box CEEM16W 2,5A, 10m SVA	1
6	6001253	switch box CEEM16W 4A, 10m SVA	1
6	6023992	switch box CEEM16W 6,3A, 20m SVA	1

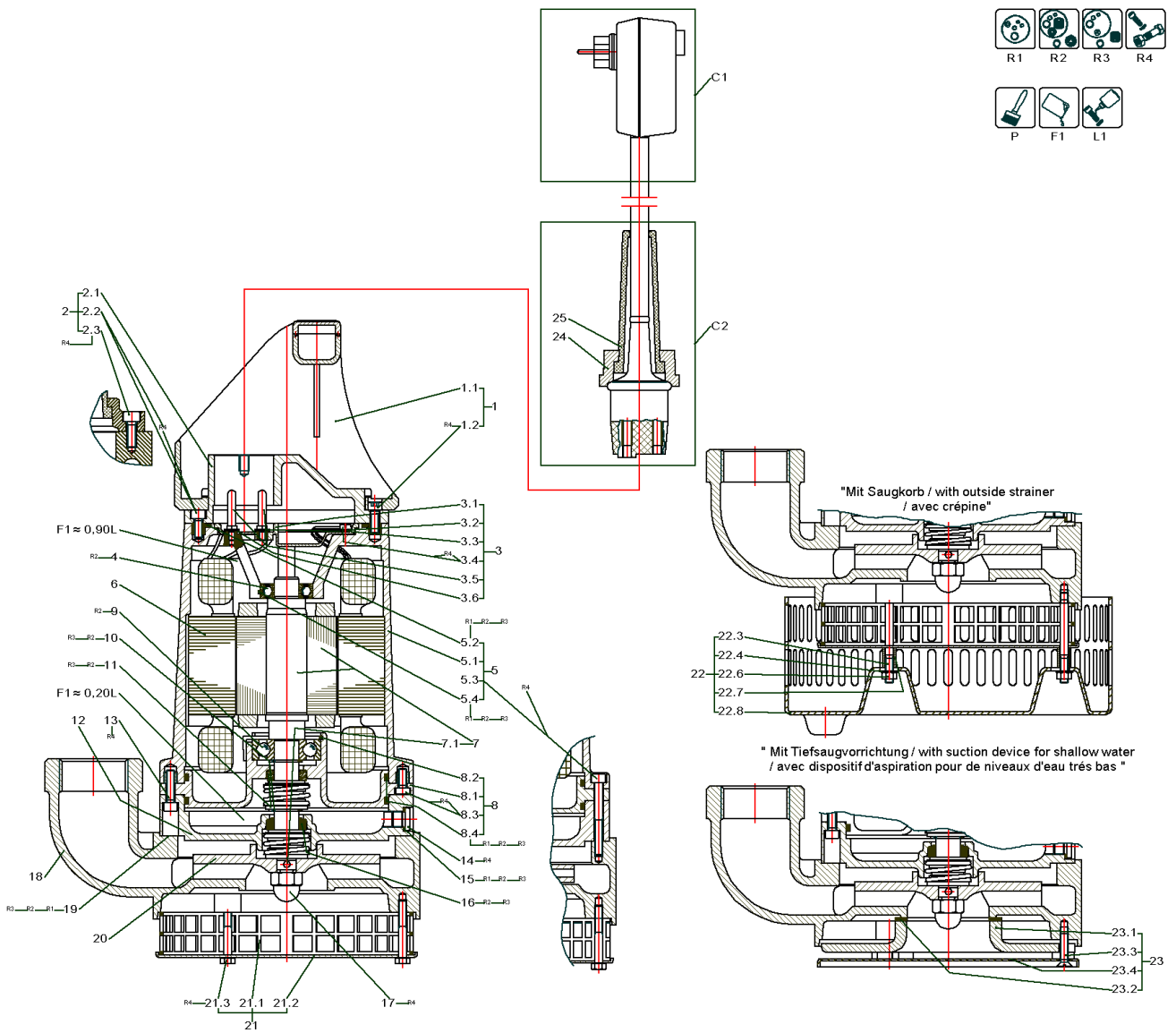

CONTRACTOR'S PUMP KS8GG UNIT (6000113)

Item	Article no.	Description	Quantity
R1	6016267	Rep.Kit 1 KS8,9,12,14,15, F12 Vit	1
R2	6016308	Rep.Kit 2 KS8,9,12,14,15	1
R3	6016307	Rep.Kit 3 KS8,9,12,14,15	1
R4	6016132	Screws KS8,9,12,14,15 KE7;8;9, F12 KIT	1
P	6042254	PAINT SPRAY Pantone334	1
P	6042255	colour 2K-paint IV80 pantone334C 250ml	1
P	6023614	Ceram C0 black 100 ml KIT	1
P	6020579	Ceram C0 black 250 ml KIT	1
P	6023485	Ceram C0 Black 500ml Kit	1
P	6019157	Ceram C0 black 1000 ml KIT	1
F1	6025460	medical white oil 1L KIT	1
F1	6025461	medical white oil 5L KIT	1
L1	6080531	Loctite 243 5g flask VP:	1
L1	2096167	Loctite 243 50ml VP.	1

C1		PLUG	1
C2		cable for motor F12 / F13	1

1	6019566	handle 51.15480/1 plastics KIT	1
1.2		> screw M5x16 ISO4762 A2-70	1
1.1		> handle 51.15480/1 Akulon	1
2	6022949	motor cover D.95,8 51.17219 GG KIT	1
2.1		> motor cover D.95,8 51.17219 GG	1
2.2		> SCREW M5X12 ISO4762 A2-70	3
2.3		> screw M6x16 DIN912 A4 (10pc)	1
3	6001273	terminal board 54.3453 Makrolon KIT	1
3.1		> terminal board plastics Polycarbonat	1
3.5		> contact pin Ms	4
3.2		> lock washer 4 DIN7980 A4	1
3.3		> washer A4,3 DIN125 Ms	5
3.4		> screw M4x8 DIN84 Ms	1
3.6		> washer 4,3 DIN7349 Ms	1
4	6086141	ball bearing 6002 VP.	1
5	6022378	motor casing 52.2924/1E GG KIT	1

CONTRACTOR'S PUMP KS8GG UNIT (6000113)

Item	Article no.	Description	Quantity
5.1		> motor casing 52.2924/1 GG	1
5.2		> o-ring ID.92,0x3,0 Viton	1
5.3		> screw M5x25 DIN912 A2-70	3
5.3		> screw M5x45 ISO4762 A2-70	3
Note: für / for / pour KS			
5.4		> o-ring ID.32x1,78 Viton	1
		Stator / stator / stator 50 Hz	
6	6023535	stator F12-2/6 230E 50Hz Ser11	1
6	6023532	stator F12-2/6 400 50Hz VN 01	1
6	6023533	stator F12-2/6 415 50Hz VN 01	1
6	6023534	stator F12-2/6 500 50Hz VN 01	1
		alternativ / alternative / alternative	
6	6023531	stator F12-2/6 230 50Hz	1
		Stator / stator / stator 60 Hz	
6	6023536	stator F12-2/6 230E 60Hz Ser11	1
6	6023537	stator F12-2/6 230/400 60Hz	1
7	6010006	rotor D.61,4x189 2/6 1.4021	1
8	6042497	bearing housing U 6050660 GG KIT	1
8.1		> lower bearing D.42H7 6050660 GG	1
8.2	6004669	> circlips 43,6x1,8 54.3438 FSt	1
8.3		> screw M5x12 DIN6912 A2-70	3
8.4		> o-ring ID.115,0x3,0 Viton -	2
9	6008975	ball bearing 6302	1
10	6002007	circlips 15x1 DIN471 FSt	2
11	6075396	mech shaft seal MG1/15-G64 BXPGG VP.	1
12	6013732	sealing casing D.125f6 53.3452 GG	1
		alternativ / alternative / alternative	
12	6013724	sealing casing D.125f6 53.3452 GG/C0	1
12	6013730	sealing casing D.125f6 53.3452 GG/C1	1
13		screw M5x20 ISO4762 A2	3
14	6002430	screw plug G1/8 DIN908 A2	1
15	6048829	joint ring A10/13,5x1,5 DIN7603 PA(10pc)	1
16	6075381	mechanical shaft seal MG1/15-G4 Q1Q1PGG	1
		alternativ / alternative / alternative	

CONTRACTOR'S PUMP KS8GG UNIT (6000113)

Item	Article no.	Description	Quantity
16	6003878	mechanical shaft seal MG1/15-G4 Q1Q1VGG	1
17	6002104	domet nut M10 DIN1587 A2	1
18	6012850	pump housing A G11/4 52.10520/2 GG	1
		alternativ / alternative / alternative	
18	6012848	pump hou. AG1 1/4 GG/C0 52.19207	1
18	6024442	pump housing A G11/4 52.19189 Abrasit	1
18	6022781	pump housing A G11/4 52.19189 Abrasit/C0	1
18	6012903	pump housing AG1 1/4 1.4581 52.16782VN00	1
19	6048831	flat gasket D.125/155 ARAMID/NBR (10pc)	1
		Laufrad / Impeller / Roue 50Hz	
20	6014013	impeller-W D.114 54.2392/1 GG	1
		alternativ / alternative / alternative	
20	6014005	impeller-W D.114 54.2392/1 GG/C0	1
20	6010632	impeller-W D.114 54.17902 Abrasit	1
20	6022790	impeller-W D.114 54.17902 Abrasit/C0	1
20	6014011	impeller-W D.114 54.2392/1 1.4581	1
		Laufrad / Impeller / Roue 60Hz	
20	6014009	impeller-W D.97 54.2114/1 GG	1
		alternativ / alternative / alternative	
20	6021758	Impeller-W D.97 54.2114/1 GG/C0	1
20	6022788	impeller-W D.97 54.17902 Abrasit	1
20	6022789	impeller-W D.97 54.17902 Abrasit/C0	1
20	6021647	impeller-W D.97 54.2114/1 1.4581	1
21	6001147	strainer 54.10534/1 1.4301 KIT	1
21.1		> strainer 26x155x2 1.4301	1
21.2		> base plate D.160x3 1,5 1.4301	1
21.3		> screw M5x35 ISO4014 A2-70	3
22	6032617	add on strainer KS 8/9 KIT	1
23	6021392	suction plate 53.17572 GG KIT	1
23.1		> suction plate 53.17572 GG	1
23.2	6004149	> flat gasket D.50/65x2 NBR	1
23.3	6002405	> screw M5x20 DIN963 A4	3
23.4		> base plate D.160x3 1,5 1.4301	1
24	6004828	cable gland Akulon	1

CONTRACTOR'S PUMP KS8GG UNIT (6000113)

Item	Article no.	Description	Quantity
25	6003824	cable peotection NBR 87x30 mm	1

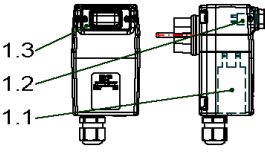
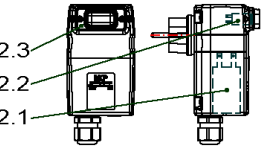
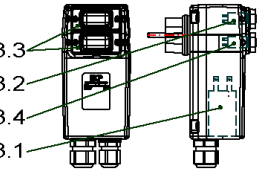
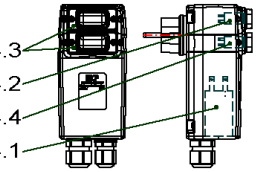
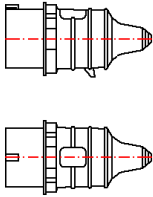
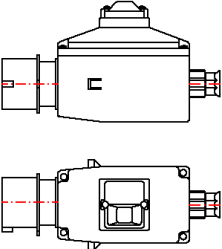
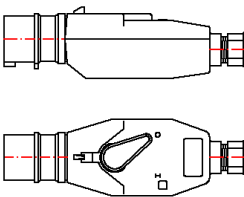
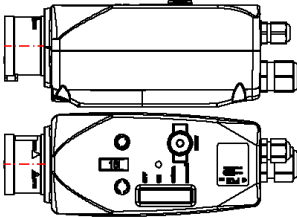
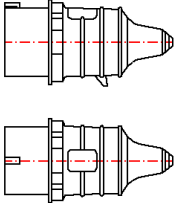
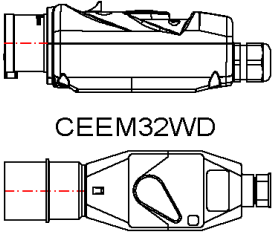
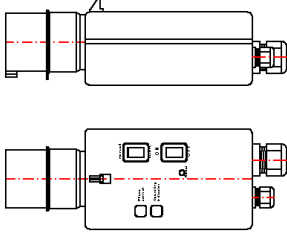
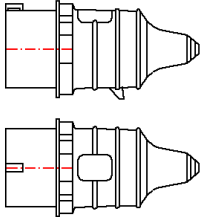
<p>1 MCP 6A-M-H-20μF ~ 230V</p>  <p>$I_N(230V / 50Hz) < 6A = 20\mu F$</p>	<p>2 MCP 10A-M-H-30μF ~ 230V</p>  <p>$I_N(230V / 50Hz) 6-10A = 30\mu F$</p>	<p>3 MCP 6A-M-HA-20μF ~ 230V</p>  <p>$I_N(230V / 50Hz) < 6A = 20\mu F$</p>	<p>4 MCP 10A-M-HA-30μF ~ 230V</p>  <p>$I_N(230V / 50Hz) 6-10A = 30\mu F$</p>
<p>5 CEE16A</p> 	<p>6 CEEM16W</p> 	<p>7 CEEM16WD</p> 	<p>8 MCP T4-HA-ROT-WSK CEE16-5PS</p> 
<p>9 CEE32A</p> 	<p>10 MCP 10-16A-T4-H-ROT CEE32-5PS</p>  <p>CEEM32WD</p>	<p>11 CEEM32WDSHA</p> 	<p>12 CEE63A</p> 

PLUG

Item	Article no.	Description	Quantity
		IN (230V / 50Hz) <6A - 20μF	
1	6072332	MCP 6A-M-H-20μF-CEE7/7 VP.	1
1.1	6071702	capacitor 400V 20μF MCP VP.	1
1.2	6071704	protection switch 6A MCP VP.	1
1.3	6071707	protecting cap MCP VP.	1
		IN (230V / 50Hz) 6-10A - 30μF	
2	6072330	MCP 10A-M-H-30μF-CEE7/7 VP.	1
2.1	6071703	capacitor 400V 30μF MCP VP.	1
2.2	6071705	protection switch 10A MCP VP.	1
2.3	6071707	protecting cap MCP VP.	1
		IN (230V / 50Hz) <6A - 20μF	
3	6072331	MCP 6A-M-HA-20μF-CEE7/7 VP.	1
3.1	6071702	capacitor 400V 20μF MCP VP.	1
3.2	6071704	protection switch 6A MCP VP.	1
3.3	6071707	protecting cap MCP VP.	2
3.4	6071706	switch on/out MCP VP.	1
		IN (230V / 50Hz) 6-10A - 30μF	
4	6072329	MCP 10A-M-HA-30μF-CEE7/7 VP	1
4.1	6071703	capacitor 400V 30μF MCP VP.	1
4.2	6071705	protection switch 10A MCP VP.	1
4.3	6071707	protecting cap MCP VP.	2
4.4	6071706	switch on/out MCP VP.	1
5	6003000	plug CEE16A/400V 60Hz/5P-11h	1
5	6003248	plug CEE16A/400V/4P-6H	1
5	6003009	plug CEE16A/400V/5P-6H	1
5	6039156	plug CEE16A/400V/5P-6H Phase inverter	1
5	6035231	plug CEE16A/400V/7P-6H	1
5	6003011	plug CEE16A/500V/5P-7H	1
6	6030883	plug MS400V5P CEE16A W 1,0-1,6A	1
6	6030884	plug MS400V5P CEE16A W 1,6-2,5A	1
6	6030888	plug MS400V5P CEE16A W 10,0-16,0A	1
6	6030885	plug MS400V5P CEE16A W 2,5-4,0A	1
6	6030886	plug MS400V5P CEE16A W 4,0-6,3A	1
6	6030887	plug MS400V5P CEE16A W 6,3-10,0A	1

PLUG

Item	Article no.	Description	Quantity
7	6032446	plug MS400V4P CEE16A WD 1,6-2,5A	1
7	6032447	plug MS400V4P CEE16A WD 12,5-16,0A	1
7	6032295	plug MS400V4P CEE16A WD 2,5-4,0A	1
7	6032289	plug MS400V4P CEE16A WD 4,0-6,3A	1
7	6032292	plug MS400V4P CEE16A WD 6,3-9,0A	1
7	6042190	plug MS400V5P CEE16A WDII 1,6-2,5A	1
7	6042194	plug MS400V5P CEE16A WDII 10,0-16,0A	1
7	6042191	plug MS400V5P CEE16A WDII 2,5-4,0A	1
7	6042192	plug MS400V5P CEE16A WDII 4,0-6,3A	1
7	6042193	plug MS400V5P CEE16A WDII 6,3-10,0A	1
7	6035911	plug MS400V5P CEE16A WD 9,0-12,5A	1
7	6003337	plug MS500V5P CEE16A WD 1,6-2,5A	1
7	6003336	plug MS500V5P CEE16A WD 2,5-4,0A	1
7	6003335	plug MS500V5P CEE16A WD 4,0-6,3A	1
7	6003334	plug MS500V5P CEE16A WD 6,3-9,0A	1
8	6072520	MCP 1,0-1,6A-T4-HA-ROT-WSK-CEE16-5PS VP.	1
8	6072521	MCP 1,6-2,4A-T4-HA-ROT-WSK-CEE16-5PS VP.	1
8	6072522	MCP 2,4-4,0A-T4-HA-ROT-WSK-CEE16-5PS VP.	1
8	6072523	MCP 4,0-6,0A-T4-HA-ROT-WSK-CEE16-5PS VP.	1
8	6072524	MCP 6,0-10A-T4-HA-ROT-WSK-CEE16-5PS VP.	1
8	6072525	MCP 9,0-12A-T4-HA-ROT-WSK-CEE16-5PS VP.	1
8	6072526	MCP 12-16A-T4-HA-ROT-WSK-CEE16-5PS VP.	1
9	6003267	plug CEE32A/400V/4P-6H	1
9	6039155	plug CEE32A/400V/5P-6H Phase inverter	1
9	6035895	plug CEE32A/500V/4P-7H AM-Top	1
9	6003010	plug CEE32A/500V/5P-7H	1
10	6072370	MCP 400V 1,6-2,5A-T4-H-ROT-CEE32-5PS VP.	1
10	6072369	MCP 400V 2,5-4,0A-T4-H-ROT-CEE32-5PS VP.	1
10	6072371	MCP 400V 4,0-6,3A-T4-H-ROT-CEE32-5PS VP.	1
10	6072398	MCP 400V 6,3-10A-T4-H-ROT-CEE32-5PS VP.	1
10	6072519	MCP 400V 10-16A-T4-H-ROT-CEE32-5PS VP.	1
10	6072399	MCP 400V 16-20A-T4-H-ROT-CEE32-5PS VP.	1
10	6072518	MCP 400V 20-25A-T4-H-ROT-CEE32-5PS VP.	1
10	6037649	plug.MS500V4P CEE32A WD 2,5-4,0A	1

PLUG

Item	Article no.	Description	Quantity
10	6041268	plug MS500V4P CEE32A WD 4,0-6,3A	1
10	6035244	plug MS500V5P CEE32A WD 1,6-2,5A	1
10	6034700	plug MS500V5P CEE32A WD 2,5-4,0A	1
10	6041556	plug MS500V5P CEE32A WD 4,0-6,3A	1
10	6002701	plug MS500V5P CEE32A WD 9,0-12,5A	1
10	6002700	plug MS500V5P CEE32A WD 12,5-16,0A	1
11	6003241	plug MS400V5P CEE32A WDSHA 10,0-14,0A	1
11	6003266	plug MS400V5P CEE32A WDSHA 3,7-5,5A	1
11	6003265	plug MS400V5P CEE32A WDSHA 5,5-8,0A	1
11	6003264	plug MS400V5P CEE32A WDSHA 8,0-11,5A	1
12	6003012	plug CEE63A/400V/5P-6H/IP67	1

cable for motor F12 / F13

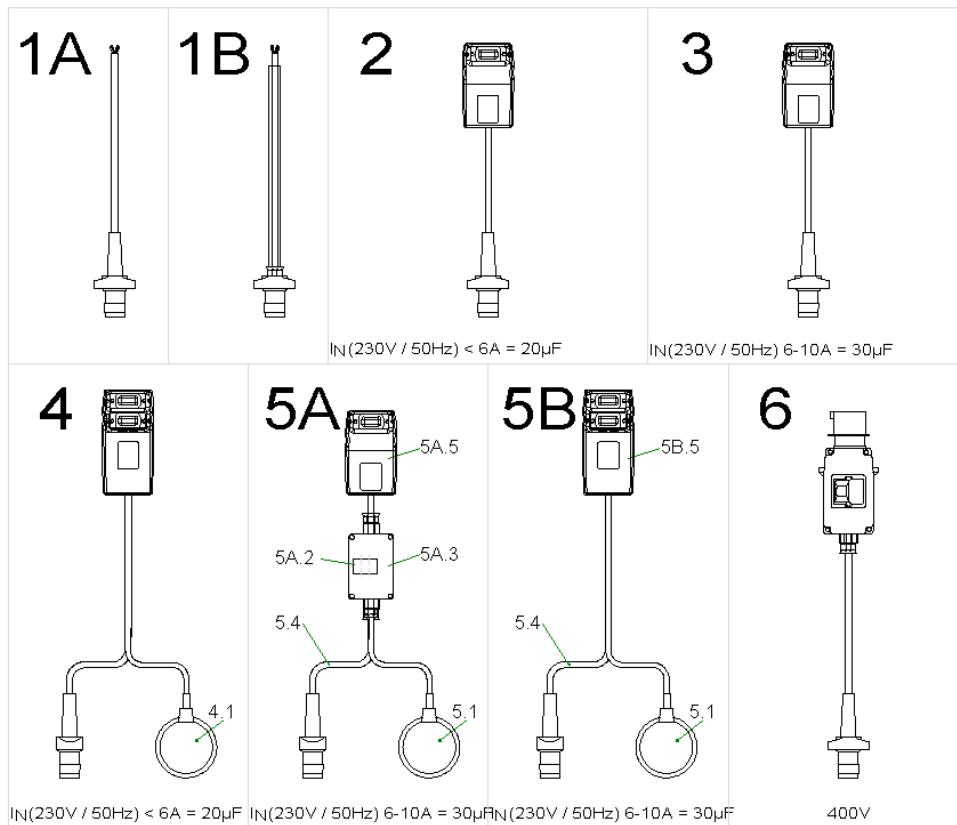

cable for motor F12 / F13

Item	Article no.	Description	Quantity
1A	6072559	cable 5m H07 4G1,5/coupling VP.	1
1A	6072560	cable 10m H07 4G1,5/coupling VP.	1
1A	6072561	cable 20m H07 4G1,5/coupling VP.	1
1A	6072562	cable 30m H07 4G1,5/coupling VP.	1
1A	6072563	cable 40m H07 4G1,5/coupling VP.	1
1A	6087533	cable 40m H07 4G1,5/coupling VP.	1
1B	6072564	cable 10m H07 4G1,5/coupl./hose VP. IN (230V / 50Hz) <6A - 20μF	1
2	6072565	switch box MCP 6A H 5M VP.	1
2	6072566	switch box MCP 6A H 10M VP.	1
2	6072567	switch box MCP 6A H 20M VP. IN (230V / 50Hz) 6-10A - 30μF	1
3	6072568	switch box MCP 10A H 5M VP.	1
3	6072569	switch box MCP 10A H 10M VP.	1
3	6072570	switch box MCP 10A H 20M VP. IN (230V / 50Hz) <6A - 20μF	1
4	6072571	switch box MCP 6A HA 5M VP.	1
4	6072572	switch box MCP 6A HA 10M VP.	1
4.1	6072582	float switch S-PS 10A 250V 10m NO VP	1
4	6072576	switch box MCP 6A HA 20M VP.	1
4.1	6072583	float switch S-PS 10A 250V 20m NO VP IN (230V / 50Hz) 6-10A - 30μF	1
5A		on request	1
5B	6072577	switch box MCP 10A HA 10M	1
5.1	6072582	float switch S-PS 10A 250V 10m NO VP	1
5A.2	6003341	contactor 5,5 kW 230 V, 50 Hz	1
5A.3	6031509	blank casing KS12/15ES KIT	1
5.4	6072560	cable 10m H07 4G1,5/coupling VP.	1
5A.5	6072330	MCP 10A-M-H-30μF-CEE7/7 VP.	1
5B.5	6072329	MCP 10A-M-HA-30μF-CEE7/7 VP für / for / pour 400V	1
6	6023991	switch box CEEM16W 2,5A, 10m SVA	1
6	6001253	switch box CEEM16W 4A, 10m SVA	1
6	6023992	switch box CEEM16W 6,3A, 20m SVA	1

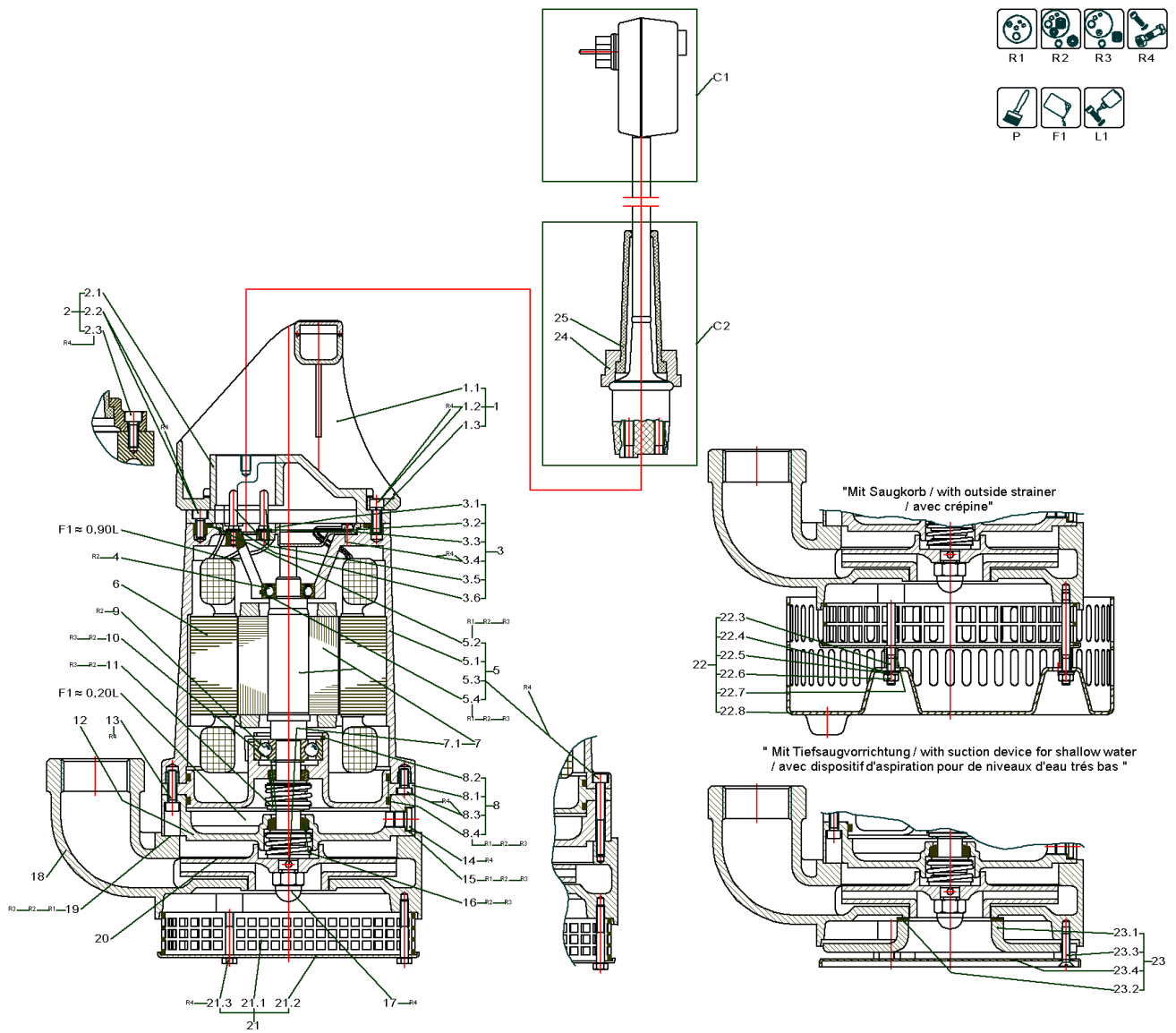

CONTRACTOR'S PUMP KS9 UNIT (6000114)

Item	Article no.	Description	Quantity
R1	6016267	Rep.Kit 1 KS8,9,12,14,15, F12 Vit	1
R2	6016308	Rep.Kit 2 KS8,9,12,14,15	1
R3	6016307	Rep.Kit 3 KS8,9,12,14,15	1
R4	6016132	Screws KS8,9,12,14,15 KE7;8;9, F12 KIT	1
P	6042254	PAINT SPRAY Pantone334	1
P	6042255	colour 2K-paint IV80 pantone334C 250ml	1
P	6023614	Ceram C0 black 100 ml KIT	1
P	6020579	Ceram C0 black 250 ml KIT	1
P	6023485	Ceram C0 Black 500ml Kit	1
P	6019157	Ceram C0 black 1000 ml KIT	1
F1	6025460	medical white oil 1L KIT	1
F1	6025461	medical white oil 5L KIT	1
L1	6080531	Loctite 243 5g flask VP:	1
L1	2096167	Loctite 243 50ml VP.	1

C2		cable for motor F12 / F13	1
C1		PLUG	1

1	6019566	handle 51.15480/1 plastics KIT	1
1.2		> screw M5x16 ISO4762 A2-70	1
1.1		> handle 51.15480/1 Akulon	1
2	6022949	motor cover D.95,8 51.17219 GG KIT	1
2.1		> motor cover D.95,8 51.17219 GG	1
2.2		> SCREW M5X12 ISO4762 A2-70	3
2.3		> screw M6x16 DIN912 A4 (10pc)	1
3	6001273	terminal board 54.3453 Makrolon KIT	1
3.1		> terminal board plastics Polycarbonat	1
3.5		> contact pin Ms	4
3.2		> lock washer 4 DIN7980 A4	1
3.3		> washer A4,3 DIN125 Ms	5
3.4		> screw M4x8 DIN84 Ms	1
3.6		> washer 4,3 DIN7349 Ms	1
4	6086141	ball bearing 6002 VP.	1
5	6021772	motor casing 52.3441 Al KIT	1

CONTRACTOR'S PUMP KS9 UNIT (6000114)

Item	Article no.	Description	Quantity
5.1		> motor casing 52.3441 Al	1
5.2		> o-ring ID.92,0x3,0 Viton	1
5.3		> screw M5x25 DIN912 A2-70	3
Note: für / for / pour KE			
5.3		> screw M5x45 ISO4762 A2-70	3
Note: für / for / pour KS			
5.4		> o-ring ID.32x1,78 Viton	1
Stator / stator / stator 50 Hz			
6	6023535	stator F12-2/6 230E 50Hz Ser11	1
6	6023532	stator F12-2/6 400 50Hz VN 01	1
6	6023533	stator F12-2/6 415 50Hz VN 01	1
6	6023534	stator F12-2/6 500 50Hz VN 01	1
alternativ / alternative / alternative			
6	6023531	stator F12-2/6 230 50Hz	1
Stator / stator / stator 60 Hz			
6	6023536	stator F12-2/6 230E 60Hz Ser11	1
6	6023537	stator F12-2/6 230/400 60Hz	1
7	6010006	rotor D.61,4x189 2/6 1.4021	1
8	6042497	bearing housing U 6050660 GG KIT	1
8.1		> lower bearing D.42H7 6050660 GG	1
8.2	6004669	> circlips 43,6x1,8 54.3438 FSt	1
8.3		> screw M5x12 DIN6912 A2-70	3
8.4		> o-ring ID.115,0x3,0 Viton -	2
9	6008975	ball bearing 6302	1
10	6002007	circlips 15x1 DIN471 FSt	2
11	6075396	mech shaft seal MG1/15-G64 BXPGG VP.	1
12	6013732	sealing casing D.125f6 53.3452 GG	1
alternativ / alternative / alternative			
12	6013724	sealing casing D.125f6 53.3452 GG/C0	1
12	6013730	sealing casing D.125f6 53.3452 GG/C1	1
13		screw M5x20 ISO4762 A2	3
14	6002430	screw plug G1/8 DIN908 A2	1
15	6048829	joint ring A10/13,5x1,5 DIN7603 PA(10pc)	1
16	6075381	mechanical shaft seal MG1/15-G4 Q1Q1PGG	1

CONTRACTOR'S PUMP KS9 UNIT (6000114)

Item	Article no.	Description	Quantity
		alternativ / alternative / alternative	
16	6003878	mechanical shaft seal MG1/15-G4 Q1Q1VGG	1
17	6002104	domet nut M10 DIN1587 A2	1
18	6012850	pump housing A G11/4 52.10520/2 GG	1
		alternativ / alternative / alternative	
18	6012848	pump hou. AG1 1/4 GG/C0 52.19207	1
18	6022781	pump housing A G11/4 52.19189 Abrasit/C0	1
19	6048831	flat gasket D.125/155 ARAMID/NBR (10pc)	1
		Laufrad / Impeller / Roue 50Hz	
20	6014029	impeller-M D.130 54.3454/1 GG	1
		alternativ / alternative / alternative	
20	6014036	impeller-M D.130 54.3454/1 GG/C0	1
		Laufrad / Impeller / Roue 60Hz	
20	6014004	impeller-M D.112 54.3013/1 GG	1
		alternativ / alternative / alternative	
20	6021112	impeller-M D.112 54.3013/1 GG/C0	1
21	6042495	suctions strainer KE/KS9 KIT	1
21.1		> strainer KE/KS 54.18920 1.4301	1
21.2		> base plate D.160x3 1,5 1.4301	1
21.3		> screw M5x35 ISO4014 A2-70	3
22	6032617	add on strainer KS 8/9 KIT	1
23	6021392	suction plate 53.17572 GG KIT	1
23.1		> suction plate 53.17572 GG	1
23.2	6004149	> flat gasket D.50/65x2 NBR	1
23.3	6002405	> screw M5x20 DIN963 A4	3
23.4		> base plate D.160x3 1,5 1.4301	1
24	6004828	cable gland Akulon	1
25	6003824	cable peotection NBR 87x30 mm	1

cable for motor F12 / F13

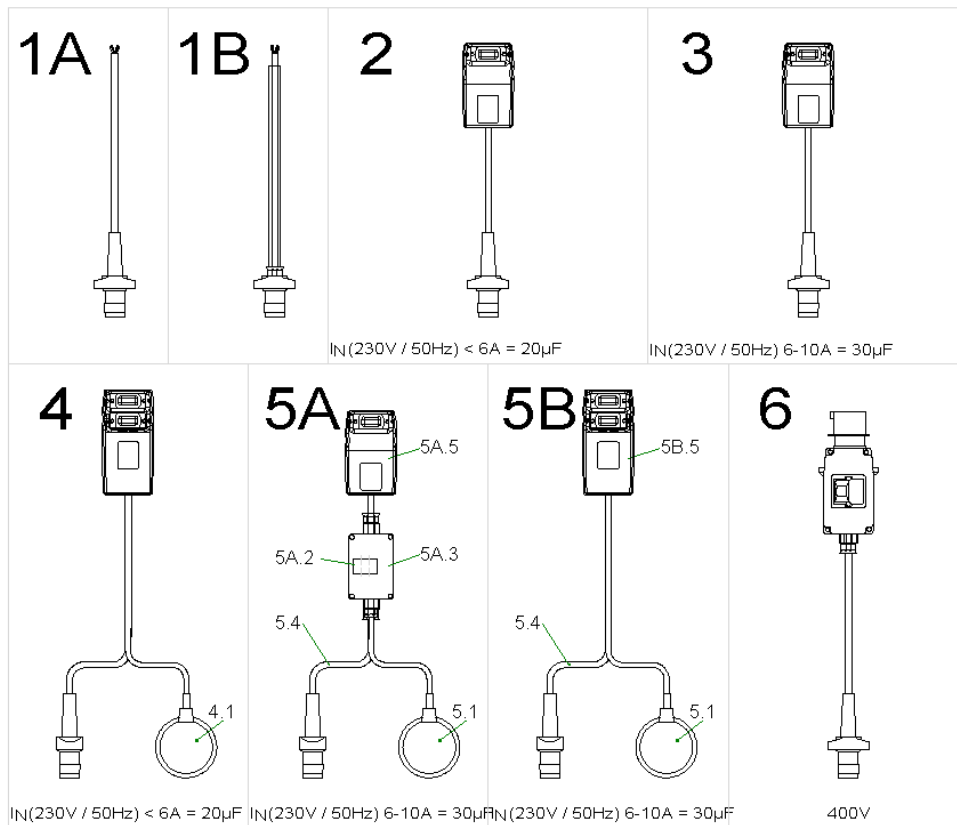

cable for motor F12 / F13

Item	Article no.	Description	Quantity
1A	6072559	cable 5m H07 4G1,5/coupling VP.	1
1A	6072560	cable 10m H07 4G1,5/coupling VP.	1
1A	6072561	cable 20m H07 4G1,5/coupling VP.	1
1A	6072562	cable 30m H07 4G1,5/coupling VP.	1
1A	6072563	cable 40m H07 4G1,5/coupling VP.	1
1A	6087533	cable 40m H07 4G1,5/coupling VP.	1
1B	6072564	cable 10m H07 4G1,5/coupl./hose VP. IN (230V / 50Hz) <6A - 20μF	1
2	6072565	switch box MCP 6A H 5M VP.	1
2	6072566	switch box MCP 6A H 10M VP.	1
2	6072567	switch box MCP 6A H 20M VP. IN (230V / 50Hz) 6-10A - 30μF	1
3	6072568	switch box MCP 10A H 5M VP.	1
3	6072569	switch box MCP 10A H 10M VP.	1
3	6072570	switch box MCP 10A H 20M VP. IN (230V / 50Hz) <6A - 20μF	1
4	6072571	switch box MCP 6A HA 5M VP.	1
4	6072572	switch box MCP 6A HA 10M VP.	1
4.1	6072582	float switch S-PS 10A 250V 10m NO VP	1
4	6072576	switch box MCP 6A HA 20M VP.	1
4.1	6072583	float switch S-PS 10A 250V 20m NO VP IN (230V / 50Hz) 6-10A - 30μF	1
5A		on request	1
5B	6072577	switch box MCP 10A HA 10M	1
5.1	6072582	float switch S-PS 10A 250V 10m NO VP	1
5A.2	6003341	contactor 5,5 kW 230 V, 50 Hz	1
5A.3	6031509	blank casing KS12/15ES KIT	1
5.4	6072560	cable 10m H07 4G1,5/coupling VP.	1
5A.5	6072330	MCP 10A-M-H-30μF-CEE7/7 VP.	1
5B.5	6072329	MCP 10A-M-HA-30μF-CEE7/7 VP für / for / pour 400V	1
6	6023991	switch box CEEM16W 2,5A, 10m SVA	1
6	6001253	switch box CEEM16W 4A, 10m SVA	1
6	6023992	switch box CEEM16W 6,3A, 20m SVA	1

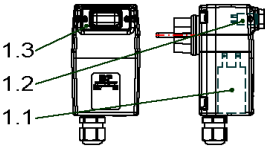
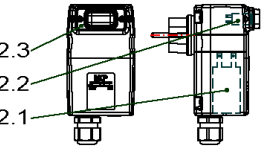
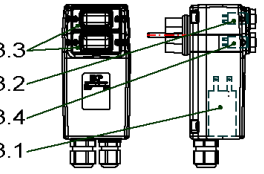
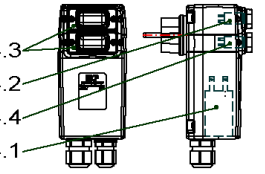
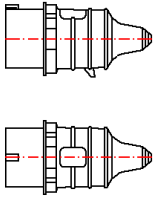
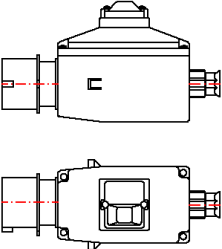
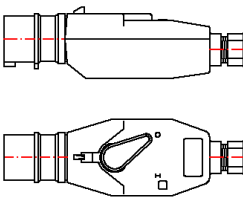
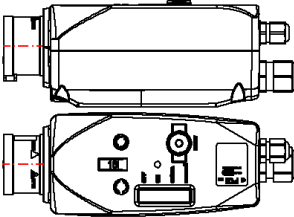
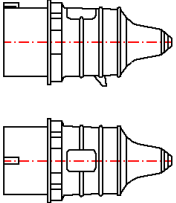
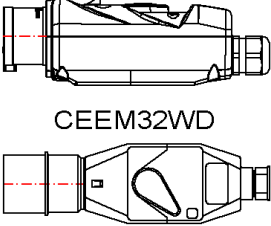
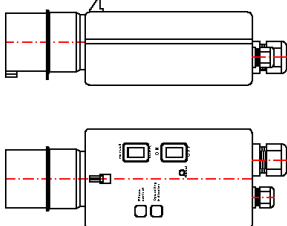
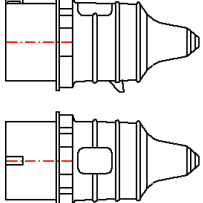
<p>1 MCP 6A-M-H-20μF ~ 230V</p>  <p>$I_N(230V / 50Hz) < 6A = 20\mu F$</p>	<p>2 MCP 10A-M-H-30μF ~ 230V</p>  <p>$I_N(230V / 50Hz) 6-10A = 30\mu F$</p>	<p>3 MCP 6A-M-HA-20μF ~ 230V</p>  <p>$I_N(230V / 50Hz) < 6A = 20\mu F$</p>	<p>4 MCP 10A-M-HA-30μF ~ 230V</p>  <p>$I_N(230V / 50Hz) 6-10A = 30\mu F$</p>
<p>5 CEE16A</p> 	<p>6 CEEM16W</p> 	<p>7 CEEM16WD</p> 	<p>8 MCP T4-HA-ROT-WSK CEE16-5PS</p> 
<p>9 CEE32A</p> 	<p>10 MCP 10-16A-T4-H-ROT CEE32-5PS</p>  <p>CEEM32WD</p>	<p>11 CEEM32WDSHA</p> 	<p>12 CEE63A</p> 

PLUG

Item	Article no.	Description	Quantity
		IN (230V / 50Hz) <6A - 20μF	
1	6072332	MCP 6A-M-H-20μF-CEE7/7 VP.	1
1.1	6071702	capacitor 400V 20μF MCP VP.	1
1.2	6071704	protection switch 6A MCP VP.	1
1.3	6071707	protecting cap MCP VP.	1
		IN (230V / 50Hz) 6-10A - 30μF	
2	6072330	MCP 10A-M-H-30μF-CEE7/7 VP.	1
2.1	6071703	capacitor 400V 30μF MCP VP.	1
2.2	6071705	protection switch 10A MCP VP.	1
2.3	6071707	protecting cap MCP VP.	1
		IN (230V / 50Hz) <6A - 20μF	
3	6072331	MCP 6A-M-HA-20μF-CEE7/7 VP.	1
3.1	6071702	capacitor 400V 20μF MCP VP.	1
3.2	6071704	protection switch 6A MCP VP.	1
3.3	6071707	protecting cap MCP VP.	2
3.4	6071706	switch on/out MCP VP.	1
		IN (230V / 50Hz) 6-10A - 30μF	
4	6072329	MCP 10A-M-HA-30μF-CEE7/7 VP	1
4.1	6071703	capacitor 400V 30μF MCP VP.	1
4.2	6071705	protection switch 10A MCP VP.	1
4.3	6071707	protecting cap MCP VP.	2
4.4	6071706	switch on/out MCP VP.	1
5	6003000	plug CEE16A/400V 60Hz/5P-11h	1
5	6003248	plug CEE16A/400V/4P-6H	1
5	6003009	plug CEE16A/400V/5P-6H	1
5	6039156	plug CEE16A/400V/5P-6H Phase inverter	1
5	6035231	plug CEE16A/400V/7P-6H	1
5	6003011	plug CEE16A/500V/5P-7H	1
6	6030883	plug MS400V5P CEE16A W 1,0-1,6A	1
6	6030884	plug MS400V5P CEE16A W 1,6-2,5A	1
6	6030888	plug MS400V5P CEE16A W 10,0-16,0A	1
6	6030885	plug MS400V5P CEE16A W 2,5-4,0A	1
6	6030886	plug MS400V5P CEE16A W 4,0-6,3A	1
6	6030887	plug MS400V5P CEE16A W 6,3-10,0A	1

PLUG

Item	Article no.	Description	Quantity
7	6032446	plug MS400V4P CEE16A WD 1,6-2,5A	1
7	6032447	plug MS400V4P CEE16A WD 12,5-16,0A	1
7	6032295	plug MS400V4P CEE16A WD 2,5-4,0A	1
7	6032289	plug MS400V4P CEE16A WD 4,0-6,3A	1
7	6032292	plug MS400V4P CEE16A WD 6,3-9,0A	1
7	6042190	plug MS400V5P CEE16A WDII 1,6-2,5A	1
7	6042194	plug MS400V5P CEE16A WDII 10,0-16,0A	1
7	6042191	plug MS400V5P CEE16A WDII 2,5-4,0A	1
7	6042192	plug MS400V5P CEE16A WDII 4,0-6,3A	1
7	6042193	plug MS400V5P CEE16A WDII 6,3-10,0A	1
7	6035911	plug MS400V5P CEE16A WD 9,0-12,5A	1
7	6003337	plug MS500V5P CEE16A WD 1,6-2,5A	1
7	6003336	plug MS500V5P CEE16A WD 2,5-4,0A	1
7	6003335	plug MS500V5P CEE16A WD 4,0-6,3A	1
7	6003334	plug MS500V5P CEE16A WD 6,3-9,0A	1
8	6072520	MCP 1,0-1,6A-T4-HA-ROT-WSK-CEE16-5PS VP.	1
8	6072521	MCP 1,6-2,4A-T4-HA-ROT-WSK-CEE16-5PS VP.	1
8	6072522	MCP 2,4-4,0A-T4-HA-ROT-WSK-CEE16-5PS VP.	1
8	6072523	MCP 4,0-6,0A-T4-HA-ROT-WSK-CEE16-5PS VP.	1
8	6072524	MCP 6,0-10A-T4-HA-ROT-WSK-CEE16-5PS VP.	1
8	6072525	MCP 9,0-12A-T4-HA-ROT-WSK-CEE16-5PS VP.	1
8	6072526	MCP 12-16A-T4-HA-ROT-WSK-CEE16-5PS VP.	1
9	6003267	plug CEE32A/400V/4P-6H	1
9	6039155	plug CEE32A/400V/5P-6H Phase inverter	1
9	6035895	plug CEE32A/500V/4P-7H AM-Top	1
9	6003010	plug CEE32A/500V/5P-7H	1
10	6072370	MCP 400V 1,6-2,5A-T4-H-ROT-CEE32-5PS VP.	1
10	6072369	MCP 400V 2,5-4,0A-T4-H-ROT-CEE32-5PS VP.	1
10	6072371	MCP 400V 4,0-6,3A-T4-H-ROT-CEE32-5PS VP.	1
10	6072398	MCP 400V 6,3-10A-T4-H-ROT-CEE32-5PS VP.	1
10	6072519	MCP 400V 10-16A-T4-H-ROT-CEE32-5PS VP.	1
10	6072399	MCP 400V 16-20A-T4-H-ROT-CEE32-5PS VP.	1
10	6072518	MCP 400V 20-25A-T4-H-ROT-CEE32-5PS VP.	1
10	6037649	plug.MS500V4P CEE32A WD 2,5-4,0A	1

PLUG

Item	Article no.	Description	Quantity
10	6041268	plug MS500V4P CEE32A WD 4,0-6,3A	1
10	6035244	plug MS500V5P CEE32A WD 1,6-2,5A	1
10	6034700	plug MS500V5P CEE32A WD 2,5-4,0A	1
10	6041556	plug MS500V5P CEE32A WD 4,0-6,3A	1
10	6002701	plug MS500V5P CEE32A WD 9,0-12,5A	1
10	6002700	plug MS500V5P CEE32A WD 12,5-16,0A	1
11	6003241	plug MS400V5P CEE32A WDSHA 10,0-14,0A	1
11	6003266	plug MS400V5P CEE32A WDSHA 3,7-5,5A	1
11	6003265	plug MS400V5P CEE32A WDSHA 5,5-8,0A	1
11	6003264	plug MS400V5P CEE32A WDSHA 8,0-11,5A	1
12	6003012	plug CEE63A/400V/5P-6H/IP67	1

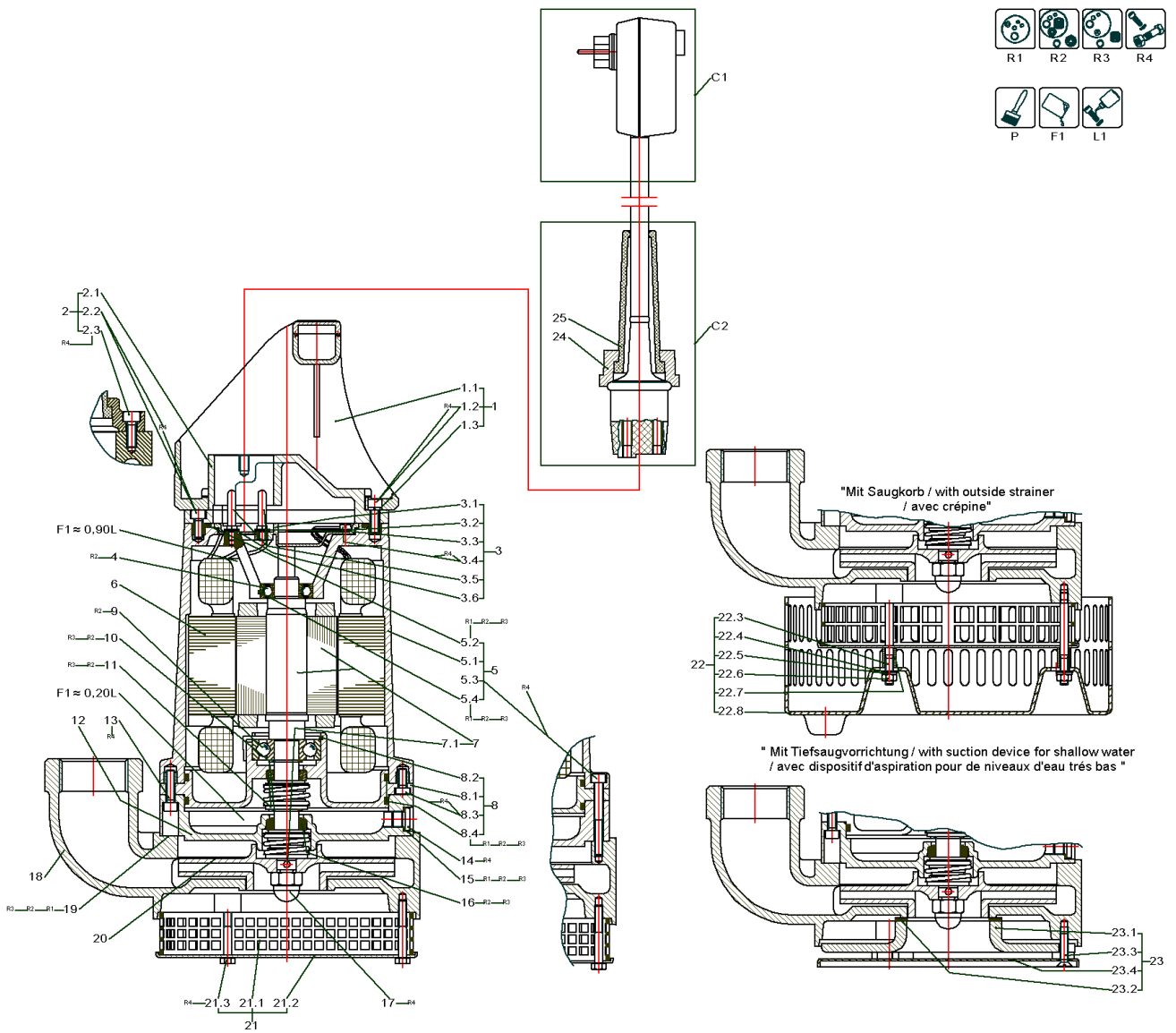

CONTRACTOR'S PUMP KS9GG UNIT (6000115)

Item	Article no.	Description	Quantity
R1	6016267	Rep.Kit 1 KS8,9,12,14,15, F12 Vit	1
R2	6016308	Rep.Kit 2 KS8,9,12,14,15	1
R3	6016307	Rep.Kit 3 KS8,9,12,14,15	1
R4	6016132	Screws KS8,9,12,14,15 KE7;8;9, F12 KIT	1
P	6042254	PAINT SPRAY Pantone334	1
P	6042255	colour 2K-paint IV80 pantone334C 250ml	1
P	6023614	Ceram C0 black 100 ml KIT	1
P	6020579	Ceram C0 black 250 ml KIT	1
P	6023485	Ceram C0 Black 500ml Kit	1
P	6019157	Ceram C0 black 1000 ml KIT	1
F1	6025460	medical white oil 1L KIT	1
F1	6025461	medical white oil 5L KIT	1
L1	6080531	Loctite 243 5g flask VP:	1
L1	2096167	Loctite 243 50ml VP.	1

C2		cable for motor F12 / F13	1
C1		PLUG	1

1	6019566	handle 51.15480/1 plastics KIT	1
1.2		> screw M5x16 ISO4762 A2-70	1
1.1		> handle 51.15480/1 Akulon	1
2	6022949	motor cover D.95,8 51.17219 GG KIT	1
2.1		> motor cover D.95,8 51.17219 GG	1
2.2		> SCREW M5X12 ISO4762 A2-70	3
2.3		> screw M6x16 DIN912 A4 (10pc)	1
3	6001273	terminal board 54.3453 Makrolon KIT	1
3.1		> terminal board plastics Polycarbonat	1
3.5		> contact pin Ms	4
3.2		> lock washer 4 DIN7980 A4	1
3.3		> washer A4,3 DIN125 Ms	5
3.4		> screw M4x8 DIN84 Ms	1
3.6		> washer 4,3 DIN7349 Ms	1
4	6086141	ball bearing 6002 VP.	1
5	6022378	motor casing 52.2924/1E GG KIT	1

CONTRACTOR'S PUMP KS9GG UNIT (6000115)

Item	Article no.	Description	Quantity
5.1		> motor casing 52.2924/1 GG	1
5.2		> o-ring ID.92,0x3,0 Viton	1
5.3		> screw M5x25 DIN912 A2-70	3
5.3		> screw M5x45 ISO4762 A2-70	3
Note: für / for / pour KS			
5.4		> o-ring ID.32x1,78 Viton	1
		Stator / stator / stator 50 Hz	
6	6023535	stator F12-2/6 230E 50Hz Ser11	1
6	6023532	stator F12-2/6 400 50Hz VN 01	1
6	6023533	stator F12-2/6 415 50Hz VN 01	1
6	6023534	stator F12-2/6 500 50Hz VN 01	1
		alternativ / alternative / alternative	
6	6023531	stator F12-2/6 230 50Hz	1
		Stator / stator / stator 60 Hz	
6	6023536	stator F12-2/6 230E 60Hz Ser11	1
6	6023537	stator F12-2/6 230/400 60Hz	1
7	6010006	rotor D.61,4x189 2/6 1.4021	1
8	6042497	bearing housing U 6050660 GG KIT	1
8.1		> lower bearing D.42H7 6050660 GG	1
8.2	6004669	> circlips 43,6x1,8 54.3438 FSt	1
8.3		> screw M5x12 DIN6912 A2-70	3
8.4		> o-ring ID.115,0x3,0 Viton -	2
9	6008975	ball bearing 6302	1
10	6002007	circlips 15x1 DIN471 FSt	2
11	6075396	mech shaft seal MG1/15-G64 BXPGG VP.	1
12	6013732	sealing casing D.125f6 53.3452 GG	1
		alternativ / alternative / alternative	
12	6013724	sealing casing D.125f6 53.3452 GG/C0	1
12	6013730	sealing casing D.125f6 53.3452 GG/C1	1
13		screw M5x20 ISO4762 A2	3
14	6002430	screw plug G1/8 DIN908 A2	1
15	6048829	joint ring A10/13,5x1,5 DIN7603 PA(10pc)	1
16	6075381	mechanical shaft seal MG1/15-G4 Q1Q1PGG	1
		alternativ / alternative / alternative	

CONTRACTOR'S PUMP KS9GG UNIT (6000115)

Item	Article no.	Description	Quantity
16	6003878	mechanical shaft seal MG1/15-G4 Q1Q1VGG	1
17	6002104	domet nut M10 DIN1587 A2	1
18	6012850	pump housing A G11/4 52.10520/2 GG	1
		alternativ / alternative / alternative	
18	6012848	pump hou. AG1 1/4 GG/C0 52.19207	1
19	6048831	flat gasket D.125/155 ARAMID/NBR (10pc)	1
		Laufrad / Impeller / Roue 50Hz	
20	6014029	impeller-M D.130 54.3454/1 GG	1
		alternativ / alternative / alternative	
20	6014036	impeller-M D.130 54.3454/1 GG/C0	1
		Laufrad / Impeller / Roue 60Hz	
20	6014004	impeller-M D.112 54.3013/1 GG	1
		alternativ / alternative / alternative	
20	6021112	impeller-M D.112 54.3013/1 GG/C0	1
21	6042495	suctions strainer KE/KS9 KIT	1
21.1		> strainer KE/KS 54.18920 1.4301	1
21.2		> base plate D.160x3 1,5 1.4301	1
21.3		> screw M5x35 ISO4014 A2-70	3
22	6032617	add on strainer KS 8/9 KIT	1
23	6021392	suction plate 53.17572 GG KIT	1
23.1		> suction plate 53.17572 GG	1
23.2	6004149	> flat gasket D.50/65x2 NBR	1
23.3	6002405	> screw M5x20 DIN963 A4	3
23.4		> base plate D.160x3 1,5 1.4301	1
24	6004828	cable gland Akulon	1
25	6003824	cable peotection NBR 87x30 mm	1

cable for motor F12 / F13

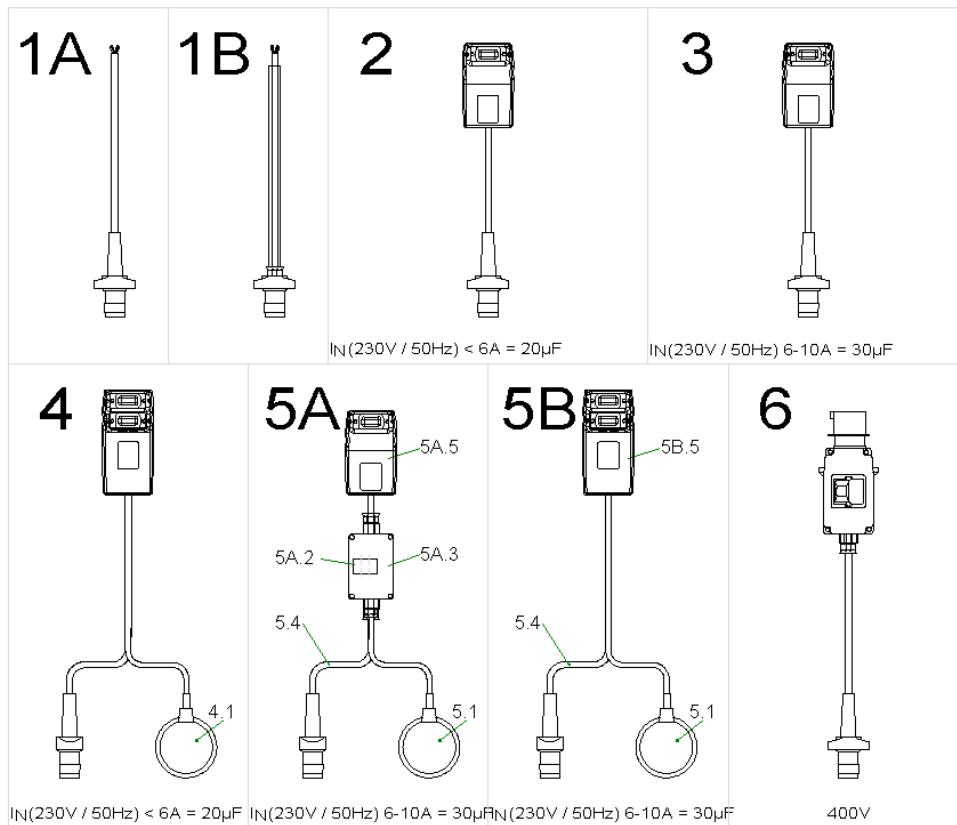

cable for motor F12 / F13

Item	Article no.	Description	Quantity
1A	6072559	cable 5m H07 4G1,5/coupling VP.	1
1A	6072560	cable 10m H07 4G1,5/coupling VP.	1
1A	6072561	cable 20m H07 4G1,5/coupling VP.	1
1A	6072562	cable 30m H07 4G1,5/coupling VP.	1
1A	6072563	cable 40m H07 4G1,5/coupling VP.	1
1A	6087533	cable 40m H07 4G1,5/coupling VP.	1
1B	6072564	cable 10m H07 4G1,5/coupl./hose VP. IN (230V / 50Hz) <6A - 20µF	1
2	6072565	switch box MCP 6A H 5M VP.	1
2	6072566	switch box MCP 6A H 10M VP.	1
2	6072567	switch box MCP 6A H 20M VP. IN (230V / 50Hz) 6-10A - 30µF	1
3	6072568	switch box MCP 10A H 5M VP.	1
3	6072569	switch box MCP 10A H 10M VP.	1
3	6072570	switch box MCP 10A H 20M VP. IN (230V / 50Hz) <6A - 20µF	1
4	6072571	switch box MCP 6A HA 5M VP.	1
4	6072572	switch box MCP 6A HA 10M VP.	1
4.1	6072582	float switch S-PS 10A 250V 10m NO VP	1
4	6072576	switch box MCP 6A HA 20M VP.	1
4.1	6072583	float switch S-PS 10A 250V 20m NO VP IN (230V / 50Hz) 6-10A - 30µF	1
5A		on request	1
5B	6072577	switch box MCP 10A HA 10M	1
5.1	6072582	float switch S-PS 10A 250V 10m NO VP	1
5A.2	6003341	contactor 5,5 kW 230 V, 50 Hz	1
5A.3	6031509	blank casing KS12/15ES KIT	1
5.4	6072560	cable 10m H07 4G1,5/coupling VP.	1
5A.5	6072330	MCP 10A-M-H-30µF-CEE7/7 VP.	1
5B.5	6072329	MCP 10A-M-HA-30µF-CEE7/7 VP für / for / pour 400V	1
6	6023991	switch box CEEM16W 2,5A, 10m SVA	1
6	6001253	switch box CEEM16W 4A, 10m SVA	1
6	6023992	switch box CEEM16W 6,3A, 20m SVA	1

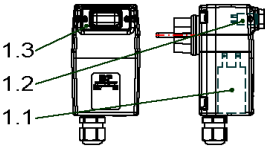
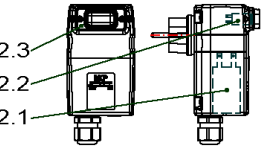
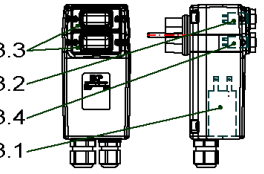
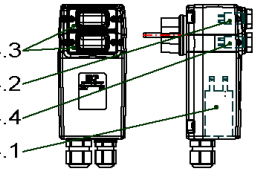
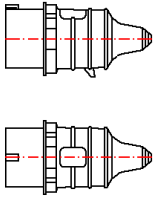
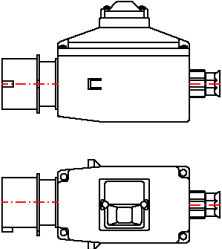
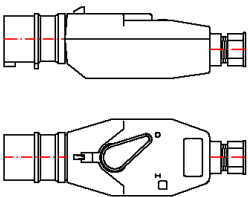
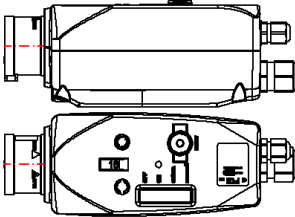
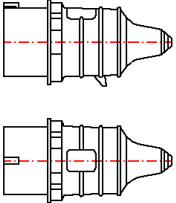
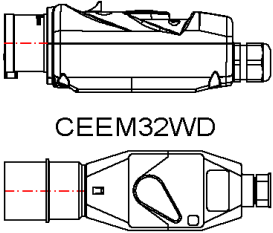
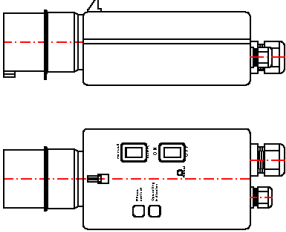
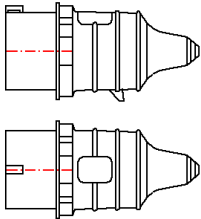
<p>1 MCP 6A-M-H-20μF ~ 230V</p>  <p>$I_N(230V / 50Hz) < 6A = 20\mu F$</p>	<p>2 MCP 10A-M-H-30μF ~ 230V</p>  <p>$I_N(230V / 50Hz) 6-10A = 30\mu F$</p>	<p>3 MCP 6A-M-HA-20μF ~ 230V</p>  <p>$I_N(230V / 50Hz) < 6A = 20\mu F$</p>	<p>4 MCP 10A-M-HA-30μF ~ 230V</p>  <p>$I_N(230V / 50Hz) 6-10A = 30\mu F$</p>
<p>5 CEE16A</p> 	<p>6 CEEM16W</p> 	<p>7 CEEM16WD</p> 	<p>8 MCP T4-HA-ROT-WSK CEE16-5PS</p> 
<p>9 CEE32A</p> 	<p>10 MCP 10-16A-T4-H-ROT CEE32-5PS</p>  <p>CEEM32WD</p>	<p>11 CEEM32WDSHA</p> 	<p>12 CEE63A</p> 

PLUG

Item	Article no.	Description	Quantity
		IN (230V / 50Hz) <6A - 20μF	
1	6072332	MCP 6A-M-H-20μF-CEE7/7 VP.	1
1.1	6071702	capacitor 400V 20μF MCP VP.	1
1.2	6071704	protection switch 6A MCP VP.	1
1.3	6071707	protecting cap MCP VP.	1
		IN (230V / 50Hz) 6-10A - 30μF	
2	6072330	MCP 10A-M-H-30μF-CEE7/7 VP.	1
2.1	6071703	capacitor 400V 30μF MCP VP.	1
2.2	6071705	protection switch 10A MCP VP.	1
2.3	6071707	protecting cap MCP VP.	1
		IN (230V / 50Hz) <6A - 20μF	
3	6072331	MCP 6A-M-HA-20μF-CEE7/7 VP.	1
3.1	6071702	capacitor 400V 20μF MCP VP.	1
3.2	6071704	protection switch 6A MCP VP.	1
3.3	6071707	protecting cap MCP VP.	2
3.4	6071706	switch on/out MCP VP.	1
		IN (230V / 50Hz) 6-10A - 30μF	
4	6072329	MCP 10A-M-HA-30μF-CEE7/7 VP	1
4.1	6071703	capacitor 400V 30μF MCP VP.	1
4.2	6071705	protection switch 10A MCP VP.	1
4.3	6071707	protecting cap MCP VP.	2
4.4	6071706	switch on/out MCP VP.	1
5	6003000	plug CEE16A/400V 60Hz/5P-11h	1
5	6003248	plug CEE16A/400V/4P-6H	1
5	6003009	plug CEE16A/400V/5P-6H	1
5	6039156	plug CEE16A/400V/5P-6H Phase inverter	1
5	6035231	plug CEE16A/400V/7P-6H	1
5	6003011	plug CEE16A/500V/5P-7H	1
6	6030883	plug MS400V5P CEE16A W 1,0-1,6A	1
6	6030884	plug MS400V5P CEE16A W 1,6-2,5A	1
6	6030888	plug MS400V5P CEE16A W 10,0-16,0A	1
6	6030885	plug MS400V5P CEE16A W 2,5-4,0A	1
6	6030886	plug MS400V5P CEE16A W 4,0-6,3A	1
6	6030887	plug MS400V5P CEE16A W 6,3-10,0A	1

PLUG

Item	Article no.	Description	Quantity
7	6032446	plug MS400V4P CEE16A WD 1,6-2,5A	1
7	6032447	plug MS400V4P CEE16A WD 12,5-16,0A	1
7	6032295	plug MS400V4P CEE16A WD 2,5-4,0A	1
7	6032289	plug MS400V4P CEE16A WD 4,0-6,3A	1
7	6032292	plug MS400V4P CEE16A WD 6,3-9,0A	1
7	6042190	plug MS400V5P CEE16A WDII 1,6-2,5A	1
7	6042194	plug MS400V5P CEE16A WDII 10,0-16,0A	1
7	6042191	plug MS400V5P CEE16A WDII 2,5-4,0A	1
7	6042192	plug MS400V5P CEE16A WDII 4,0-6,3A	1
7	6042193	plug MS400V5P CEE16A WDII 6,3-10,0A	1
7	6035911	plug MS400V5P CEE16A WD 9,0-12,5A	1
7	6003337	plug MS500V5P CEE16A WD 1,6-2,5A	1
7	6003336	plug MS500V5P CEE16A WD 2,5-4,0A	1
7	6003335	plug MS500V5P CEE16A WD 4,0-6,3A	1
7	6003334	plug MS500V5P CEE16A WD 6,3-9,0A	1
8	6072520	MCP 1,0-1,6A-T4-HA-ROT-WSK-CEE16-5PS VP.	1
8	6072521	MCP 1,6-2,4A-T4-HA-ROT-WSK-CEE16-5PS VP.	1
8	6072522	MCP 2,4-4,0A-T4-HA-ROT-WSK-CEE16-5PS VP.	1
8	6072523	MCP 4,0-6,0A-T4-HA-ROT-WSK-CEE16-5PS VP.	1
8	6072524	MCP 6,0-10A-T4-HA-ROT-WSK-CEE16-5PS VP.	1
8	6072525	MCP 9,0-12A-T4-HA-ROT-WSK-CEE16-5PS VP.	1
8	6072526	MCP 12-16A-T4-HA-ROT-WSK-CEE16-5PS VP.	1
9	6003267	plug CEE32A/400V/4P-6H	1
9	6039155	plug CEE32A/400V/5P-6H Phase inverter	1
9	6035895	plug CEE32A/500V/4P-7H AM-Top	1
9	6003010	plug CEE32A/500V/5P-7H	1
10	6072370	MCP 400V 1,6-2,5A-T4-H-ROT-CEE32-5PS VP.	1
10	6072369	MCP 400V 2,5-4,0A-T4-H-ROT-CEE32-5PS VP.	1
10	6072371	MCP 400V 4,0-6,3A-T4-H-ROT-CEE32-5PS VP.	1
10	6072398	MCP 400V 6,3-10A-T4-H-ROT-CEE32-5PS VP.	1
10	6072519	MCP 400V 10-16A-T4-H-ROT-CEE32-5PS VP.	1
10	6072399	MCP 400V 16-20A-T4-H-ROT-CEE32-5PS VP.	1
10	6072518	MCP 400V 20-25A-T4-H-ROT-CEE32-5PS VP.	1
10	6037649	plug.MS500V4P CEE32A WD 2,5-4,0A	1

PLUG

Item	Article no.	Description	Quantity
10	6041268	plug MS500V4P CEE32A WD 4,0-6,3A	1
10	6035244	plug MS500V5P CEE32A WD 1,6-2,5A	1
10	6034700	plug MS500V5P CEE32A WD 2,5-4,0A	1
10	6041556	plug MS500V5P CEE32A WD 4,0-6,3A	1
10	6002701	plug MS500V5P CEE32A WD 9,0-12,5A	1
10	6002700	plug MS500V5P CEE32A WD 12,5-16,0A	1
11	6003241	plug MS400V5P CEE32A WDSHA 10,0-14,0A	1
11	6003266	plug MS400V5P CEE32A WDSHA 3,7-5,5A	1
11	6003265	plug MS400V5P CEE32A WDSHA 5,5-8,0A	1
11	6003264	plug MS400V5P CEE32A WDSHA 8,0-11,5A	1
12	6003012	plug CEE63A/400V/5P-6H/IP67	1

CONTRACTOR'S PUMP KS12 E GG (6042086)

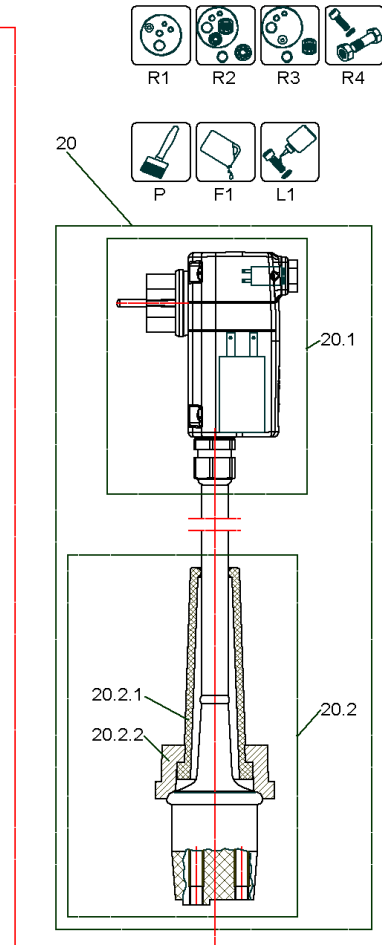
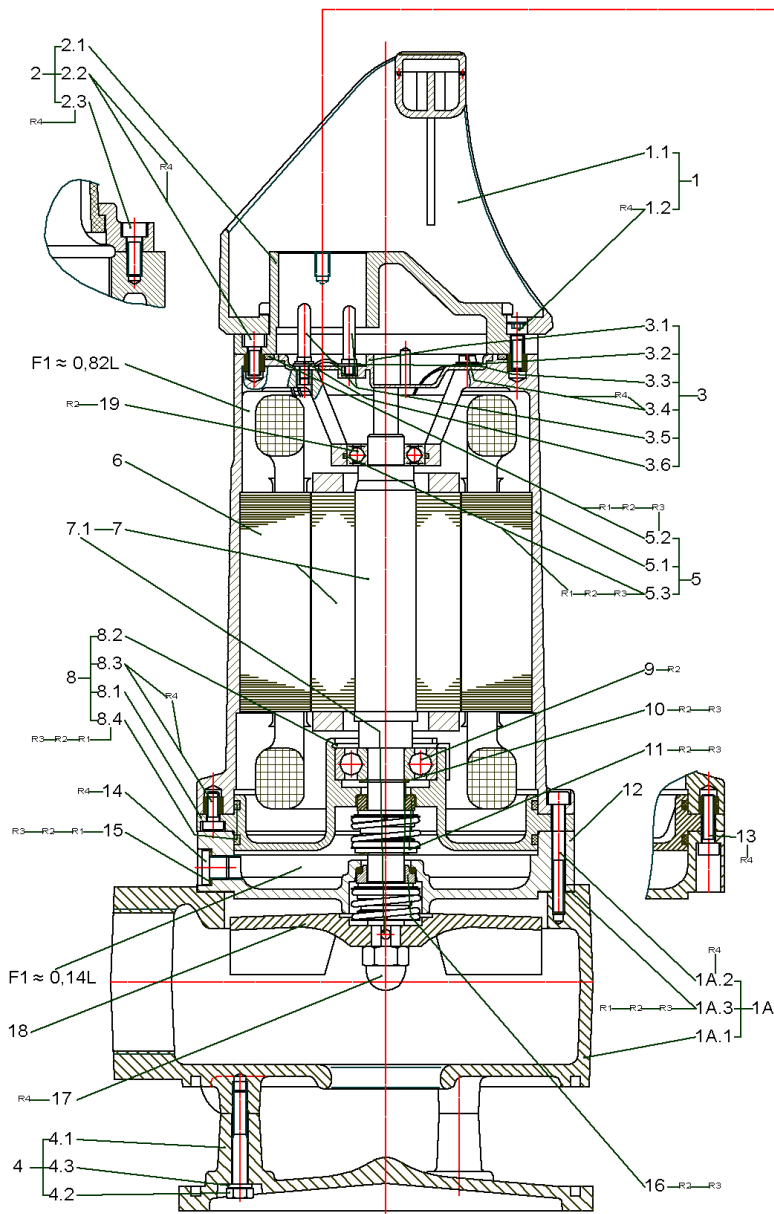

CONTRACTOR'S PUMP KS12 E GG (6042086)

Item	Article no.	Description	Quantity
R1	6016267	Rep.Kit 1 KS8,9,12,14,15, F12 Vit	1
R2	6016308	Rep.Kit 2 KS8,9,12,14,15	1
R3	6016307	Rep.Kit 3 KS8,9,12,14,15	1
R4	6016132	Screws KS8,9,12,14,15 KE7;8;9, F12 KIT	1
P	6042254	PAINT SPRAY Pantone334	1
P	6042255	colour 2K-paint IV80 pantone334C 250ml	1
F1	6025460	medical white oil 1L KIT	1
F1	6025461	medical white oil 5L KIT	1
L1	6080531	Loctite 243 5g flask VP:	1
L1	2096167	Loctite 243 50ml VP.	1

20	6072569	switch box MCP 10A H 10M VP.	1
20.1	6072330	MCP 10A-M-H-30µF-CEE7/7 VP.	1
20.2	6072560	cable 10m H07 4G1,5/coupling VP.	1
20.2.1	6004828	cable gland Akulon	1
20.2.2	6003824	cable peotection NBR 87x30 mm	1

1	6019566	handle 51.15480/1 plastics KIT	1
1.2		> screw M5x16 ISO4762 A2-70	1
1.1		> handle 51.15480/1 Akulon	1
2	6022949	motor cover D.95,8 51.17219 GG KIT	1
2.1		> motor cover D.95,8 51.17219 GG	1
2.2		> SCREW M5X12 ISO4762 A2-70	3
2.3		> screw M6x16 DIN912 A4 (10pc)	1
3	6001273	terminal board 54.3453 Makrolon KIT	1
3.1		> terminal board plastics Polycarbonat	1
3.5		> contact pin Ms	4
3.2		> lock washer 4 DIN7980 A4	1
3.3		> washer A4,3 DIN125 Ms	5
3.4		> screw M4x8 DIN84 Ms	1
3.6		> washer 4,3 DIN7349 Ms	1
19	6086141	ball bearing 6002 VP.	1
5.1	6013826	motor casing 52.12657 GG	1
5.2		o-ring ID.92,0x3,0 Viton	1

CONTRACTOR'S PUMP KS12 E GG (6042086)

Item	Article no.	Description	Quantity
5.3		o-ring ID.32x1,78 Viton	1
6	6023541	stator F12-2/9 230E 50Hz Ser11	1
7	6010002	rotor D.61,4x225 2/9 1.4021	1
8	6042497	bearing housing U 6050660 GG KIT	1
8.1		> lower bearing D.42H7 6050660 GG	1
8.2	6004669	> circlips 43,6x1,8 54.3438 FSt	1
8.3		> screw M5x12 DIN6912 A2-70	3
8.4		> o-ring ID.115,0x3,0 Viton -	2
9	6008975	ball bearing 6302	1
10	6002007	circlips 15x1 DIN471 FSt	2
11	6075396	mech shaft seal MG1/15-G64 BXPPG VP.	1
12	6013732	sealing casing D.125f6 53.3452 GG	1
13		screw M5x20 ISO4762 A2	3
14	6002430	screw plug G1/8 DIN908 A2	1
15	6048829	joint ring A10/13,5x1,5 DIN7603 PA(10pc)	1
16	6075381	mechanical shaft seal MG1/15-G4 Q1Q1PPG	1
1A	6043071	pump housing Q50 53.13605/1 GG KIT	1
1A.1		> pump housing Q50 53.13605/1 GG	1
1A.2	6003722	> screw M5x45 DIN912 A4-70	3
1A.3	6004232	> flat gasket D.125/155x0,2 paper	1
17	6002103	domet nut M10 DIN1587 A4	1
18	6013619	impeller-W D.128 54.13602/2 GG	1
4	6037169	pump foot D.170 53.14488 GG KIT	1
4.1		> base plate D.170 53.14488 GG	1
4.2	6003603	> screw M6x40 ISO4014 A2-70	3
4.3	6080475	> washer A6,4 DIN125 A4 (20pc)	1

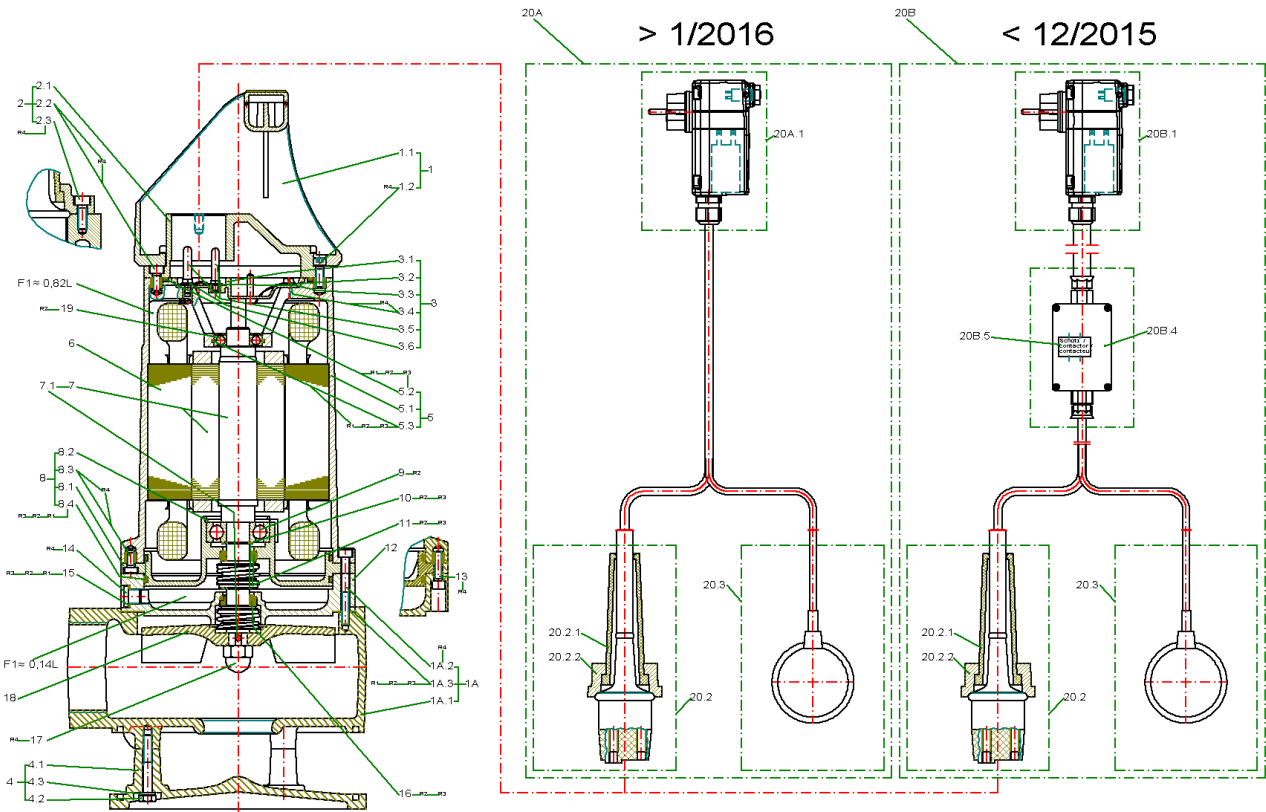

CONTRACTOR'S PUMP KS12 ES GG (6042088)

Item	Article no.	Description	Quantity
P	6042255	colour 2K-paint IV80 pantone334C 250ml	1
R1	6016267	Rep.Kit 1 KS8,9,12,14,15, F12 Vit	1
R2	6016308	Rep.Kit 2 KS8,9,12,14,15	1
R3	6016307	Rep.Kit 3 KS8,9,12,14,15	1
R4	6016132	Screws KS8,9,12,14,15 KE7;8;9, F12 KIT	1
P	6042254	PAINT SPRAY Pantone334	1
P	6023485	Ceram C0 Black 500ml Kit	1
P	6019157	Ceram C0 black 1000 ml KIT	1
F1	6025460	medical white oil 1L KIT	1
F1	6025461	medical white oil 5L KIT	1
L1	6080531	Loctite 243 5g flask VP:	1
L1	2096167	Loctite 243 50ml VP.	1

20A	6072577	switch box MCP 10A HA 10M	1
20B		No longer available	1
20A.1	6072329	MCP 10A-M-HA-30µF-CEE7/7 VP	1
20B.1	6072330	MCP 10A-M-H-30µF-CEE7/7 VP.	1
20.2	6072560	cable 10m H07 4G1,5/coupling VP.	1
20.2.1	6004828	cable gland Akulon	1
20.2.2	6003824	cable peotection NBR 87x30 mm	1
20.3	6072582	float switch S-PS 10A 250V 10m NO VP	1
20B.4	6031509	blank casing KS12/15ES KIT	1
20B.5	6003341	contactor 5,5 kW 230 V, 50 Hz	1

1	6019566	handle 51.15480/1 plastics KIT	1
1.2		> screw M5x16 ISO4762 A2-70	1
1.1		> handle 51.15480/1 Akulon	1
2	6022949	motor cover D.95,8 51.17219 GG KIT	1
2.1		> motor cover D.95,8 51.17219 GG	1
2.2		> SCREW M5X12 ISO4762 A2-70	3
2.3		> screw M6x16 DIN912 A4 (10pc)	1
3	6001273	terminal board 54.3453 Makrolon KIT	1
3.1		> terminal board plastics Polycarbonat	1
3.5		> contact pin Ms	4

CONTRACTOR'S PUMP KS12 ES GG (6042088)

Item	Article no.	Description	Quantity
3.2		> lock washer 4 DIN7980 A4	1
3.3		> washer A4,3 DIN125 Ms	5
3.4		> screw M4x8 DIN84 Ms	1
3.6		> washer 4,3 DIN7349 Ms	1
4	6037169	pump foot D.170 53.14488 GG KIT	1
4.1		> base plate D.170 53.14488 GG	1
4.2	6003603	> screw M6x40 ISO4014 A2-70	3
4.3	6080475	> washer A6,4 DIN125 A4 (20pc)	1
5.1	6013826	motor casing 52.12657 GG	1
5.2		o-ring ID.92,0x3,0 Viton	1
5.3		o-ring ID.32x1,78 Viton	1
6	6023541	stator F12-2/9 230E 50Hz Ser11	1
7	6010002	rotor D.61,4x225 2/9 1.4021	1
8	6042497	bearing housing U 6050660 GG KIT	1
8.1		> lower bearing D.42H7 6050660 GG	1
8.2	6004669	> circlips 43,6x1,8 54.3438 FSt	1
8.3		> screw M5x12 DIN6912 A2-70	3
8.4		> o-ring ID.115,0x3,0 Viton -	2
9	6008975	ball bearing 6302	1
10	6002007	circlips 15x1 DIN471 FSt	2
11	6075396	mech shaft seal MG1/15-G64 BXPPGG VP.	1
12	6013732	sealing casing D.125f6 53.3452 GG	1
13		screw M5x20 ISO4762 A2	3
14	6002430	screw plug G1/8 DIN908 A2	1
15	6048829	joint ring A10/13,5x1,5 DIN7603 PA(10pc)	1
16	6075381	mechanical shaft seal MG1/15-G4 Q1Q1PPGG	1
1A	6043071	pump housing Q50 53.13605/1 GG KIT	1
1A.1		> pump housing Q50 53.13605/1 GG	1
1A.2	6003722	> screw M5x45 DIN912 A4-70	3
1A.3	6004232	> flat gasket D.125/155x0,2 paper	1
17	6002103	domet nut M10 DIN1587 A4	1
18	6013619	impeller-W D.128 54.13602/2 GG	1
19	6086141	ball bearing 6002 VP.	1

CONTRACTOR'S PUMP KS12 D GG (6042087)

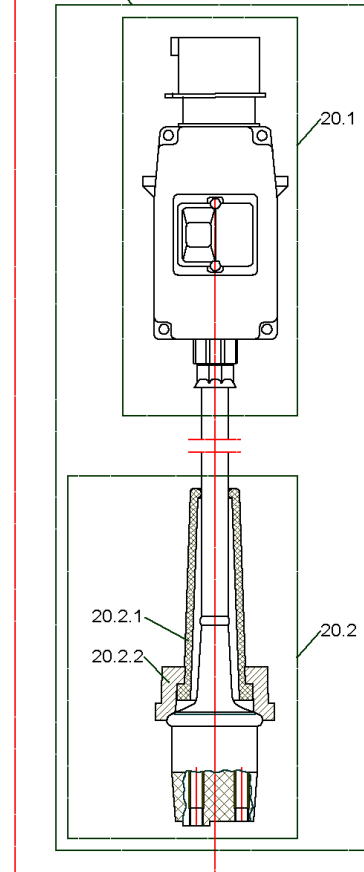
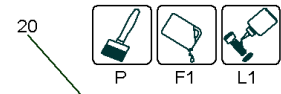
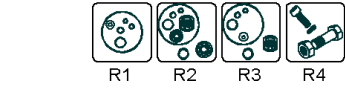
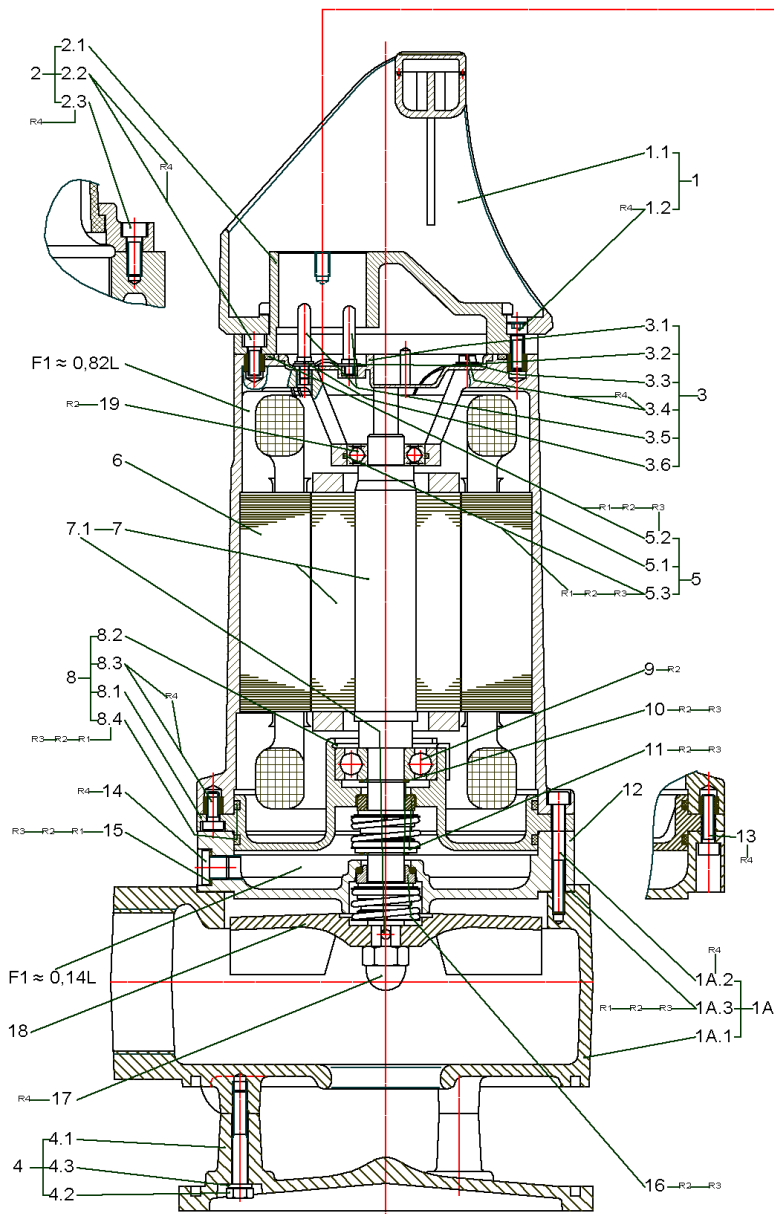

CONTRACTOR'S PUMP KS12 D GG (6042087)

Item	Article no.	Description	Quantity
R1	6016267	Rep.Kit 1 KS8,9,12,14,15, F12 Vit	1
R2	6016308	Rep.Kit 2 KS8,9,12,14,15	1
R3	6016307	Rep.Kit 3 KS8,9,12,14,15	1
R4	6016132	Screws KS8,9,12,14,15 KE7;8;9, F12 KIT	1
P	6042254	PAINT SPRAY Pantone334	1
P	6042255	colour 2K-paint IV80 pantone334C 250ml	1
F1	6025460	medical white oil 1L KIT	1
F1	6025461	medical white oil 5L KIT	1
L1	6080531	Loctite 243 5g flask VP:	1
L1	2096167	Loctite 243 50ml VP.	1

20	6001253	switch box CEEM16W 4A, 10m SVA	1
20.1	6030885	plug MS400V5P CEE16A W 2,5-4,0A	1
20.2	6072560	cable 10m H07 4G1,5/coupling VP.	1
20.2.1	6004828	cable gland Akulon	1
20.2.2	6003824	cable peotection NBR 87x30 mm	1

1	6019566	handle 51.15480/1 plastics KIT	1
1.2		> screw M5x16 ISO4762 A2-70	1
1.1		> handle 51.15480/1 Akulon	1
2	6022949	motor cover D.95,8 51.17219 GG KIT	1
2.1		> motor cover D.95,8 51.17219 GG	1
2.2		> SCREW M5X12 ISO4762 A2-70	3
2.3		> screw M6x16 DIN912 A4 (10pc)	1
3	6001273	terminal board 54.3453 Makrolon KIT	1
3.1		> terminal board plastics Polycarbonat	1
3.5		> contact pin Ms	4
3.2		> lock washer 4 DIN7980 A4	1
3.3		> washer A4,3 DIN125 Ms	5
3.4		> screw M4x8 DIN84 Ms	1
3.6		> washer 4,3 DIN7349 Ms	1
19	6086141	ball bearing 6002 VP.	1
5.1	6013826	motor casing 52.12657 GG	1
5.2		o-ring ID.92,0x3,0 Viton	1

CONTRACTOR'S PUMP KS12 D GG (6042087)

Item	Article no.	Description	Quantity
5.3		o-ring ID.32x1,78 Viton	1
6	6023538	stator F12-2/9 230/400 50Hz	1
7	6010002	rotor D.61,4x225 2/9 1.4021	1
8	6042497	bearing housing U 6050660 GG KIT	1
8.1		> lower bearing D.42H7 6050660 GG	1
8.2	6004669	> circlips 43,6x1,8 54.3438 FSt	1
8.3		> screw M5x12 DIN6912 A2-70	3
8.4		> o-ring ID.115,0x3,0 Viton -	2
9	6008975	ball bearing 6302	1
10	6002007	circlips 15x1 DIN471 FSt	2
11	6075396	mech shaft seal MG1/15-G64 BXPPG VP.	1
12	6013732	sealing casing D.125f6 53.3452 GG	1
13		screw M5x20 ISO4762 A2	3
14	6002430	screw plug G1/8 DIN908 A2	1
15	6048829	joint ring A10/13,5x1,5 DIN7603 PA(10pc)	1
16	6075381	mechanical shaft seal MG1/15-G4 Q1Q1PPG	1
1A	6043071	pump housing Q50 53.13605/1 GG KIT	1
1A.1		> pump housing Q50 53.13605/1 GG	1
1A.2	6003722	> screw M5x45 DIN912 A4-70	3
1A.3	6004232	> flat gasket D.125/155x0,2 paper	1
17	6002103	domet nut M10 DIN1587 A4	1
18	6013619	impeller-W D.128 54.13602/2 GG	1
4	6037169	pump foot D.170 53.14488 GG KIT	1
4.1		> base plate D.170 53.14488 GG	1
4.2	6003603	> screw M6x40 ISO4014 A2-70	3
4.3	6080475	> washer A6,4 DIN125 A4 (20pc)	1

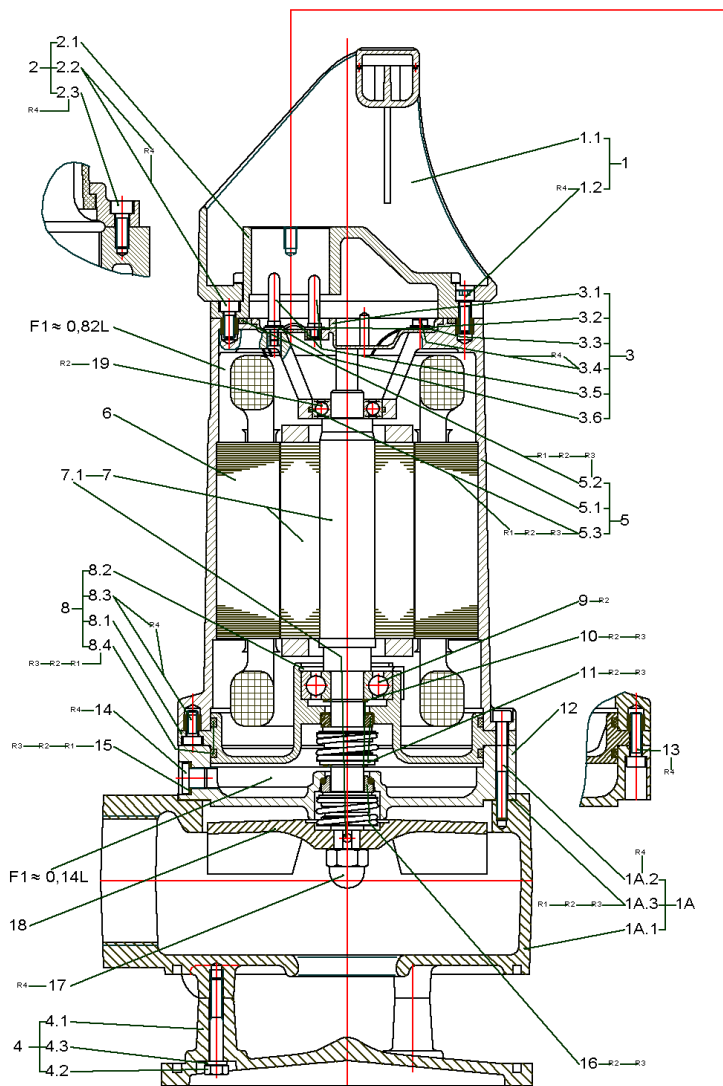

CONTRACTOR'S PUMP KS12 DS GG (6042089)

Item	Article no.	Description	Quantity
R1	6016267	Rep.Kit 1 KS8,9,12,14,15, F12 Vit	1
R2	6016308	Rep.Kit 2 KS8,9,12,14,15	1
R3	6016307	Rep.Kit 3 KS8,9,12,14,15	1
R4	6016132	Screws KS8,9,12,14,15 KE7;8;9, F12 KIT	1
P	6042254	PAINT SPRAY Pantone334	1
P	6042255	colour 2K-paint IV80 pantone334C 250ml	1
F1	6025460	medical white oil 1L KIT	1
F1	6025461	medical white oil 5L KIT	1
L1	6080531	Loctite 243 5g flask VP:	1
L1	2096167	Loctite 243 50ml VP.	1

20	6072522	MCP 2,4-4,0A-T4-HA-ROT-WSK-CEE16-5PS VP.	1
21	6072582	float switch S-PS 10A 250V 10m NO VP	1
22	6072560	cable 10m H07 4G1,5/coupling VP.	1
22.1	6004828	cable gland Akulon	1
22.2	6003824	cable peotection NBR 87x30 mm	1

1	6019566	handle 51.15480/1 plastics KIT	1
1.2		> screw M5x16 ISO4762 A2-70	1
1.1		> handle 51.15480/1 Akulon	1
2	6022949	motor cover D.95,8 51.17219 GG KIT	1
2.1		> motor cover D.95,8 51.17219 GG	1
2.2		> SCREW M5X12 ISO4762 A2-70	3
2.3		> screw M6x16 DIN912 A4 (10pc)	1
3	6001273	terminal board 54.3453 Makrolon KIT	1
3.1		> terminal board plastics Polycarbonat	1
3.5		> contact pin Ms	4
3.2		> lock washer 4 DIN7980 A4	1
3.3		> washer A4,3 DIN125 Ms	5
3.4		> screw M4x8 DIN84 Ms	1
3.6		> washer 4,3 DIN7349 Ms	1
19	6086141	ball bearing 6002 VP.	1
5.1	6013826	motor casing 52.12657 GG	1
5.2		o-ring ID.92,0x3,0 Viton	1

CONTRACTOR'S PUMP KS12 DS GG (6042089)

Item	Article no.	Description	Quantity
5.3		o-ring ID.32x1,78 Viton	1
6	6023538	stator F12-2/9 230/400 50Hz	1
7	6010002	rotor D.61,4x225 2/9 1.4021	1
8	6042497	bearing housing U 6050660 GG KIT	1
8.1		> lower bearing D.42H7 6050660 GG	1
8.2	6004669	> circlips 43,6x1,8 54.3438 FSt	1
8.3		> screw M5x12 DIN6912 A2-70	3
8.4		> o-ring ID.115,0x3,0 Viton -	2
9	6008975	ball bearing 6302	1
10	6002007	circlips 15x1 DIN471 FSt	2
11	6075396	mech shaft seal MG1/15-G64 BXPGG VP.	1
12	6013732	sealing casing D.125f6 53.3452 GG	1
13		screw M5x20 ISO4762 A2	3
14	6002430	screw plug G1/8 DIN908 A2	1
15	6048829	joint ring A10/13,5x1,5 DIN7603 PA(10pc)	1
16	6075381	mechanical shaft seal MG1/15-G4 Q1Q1PGG	1
1A	6043071	pump housing Q50 53.13605/1 GG KIT	1
1A.1		> pump housing Q50 53.13605/1 GG	1
1A.2	6003722	> screw M5x45 DIN912 A4-70	3
1A.3	6004232	> flat gasket D.125/155x0,2 paper	1
17	6002103	domet nut M10 DIN1587 A4	1
18	6013619	impeller-W D.128 54.13602/2 GG	1
4	6037169	pump foot D.170 53.14488 GG KIT	1
4.1		> base plate D.170 53.14488 GG	1
4.2	6003603	> screw M6x40 ISO4014 A2-70	3
4.3	6080475	> washer A6,4 DIN125 A4 (20pc)	1

CONTRACTOR'S PUMP KS14 UNIT (6000086)

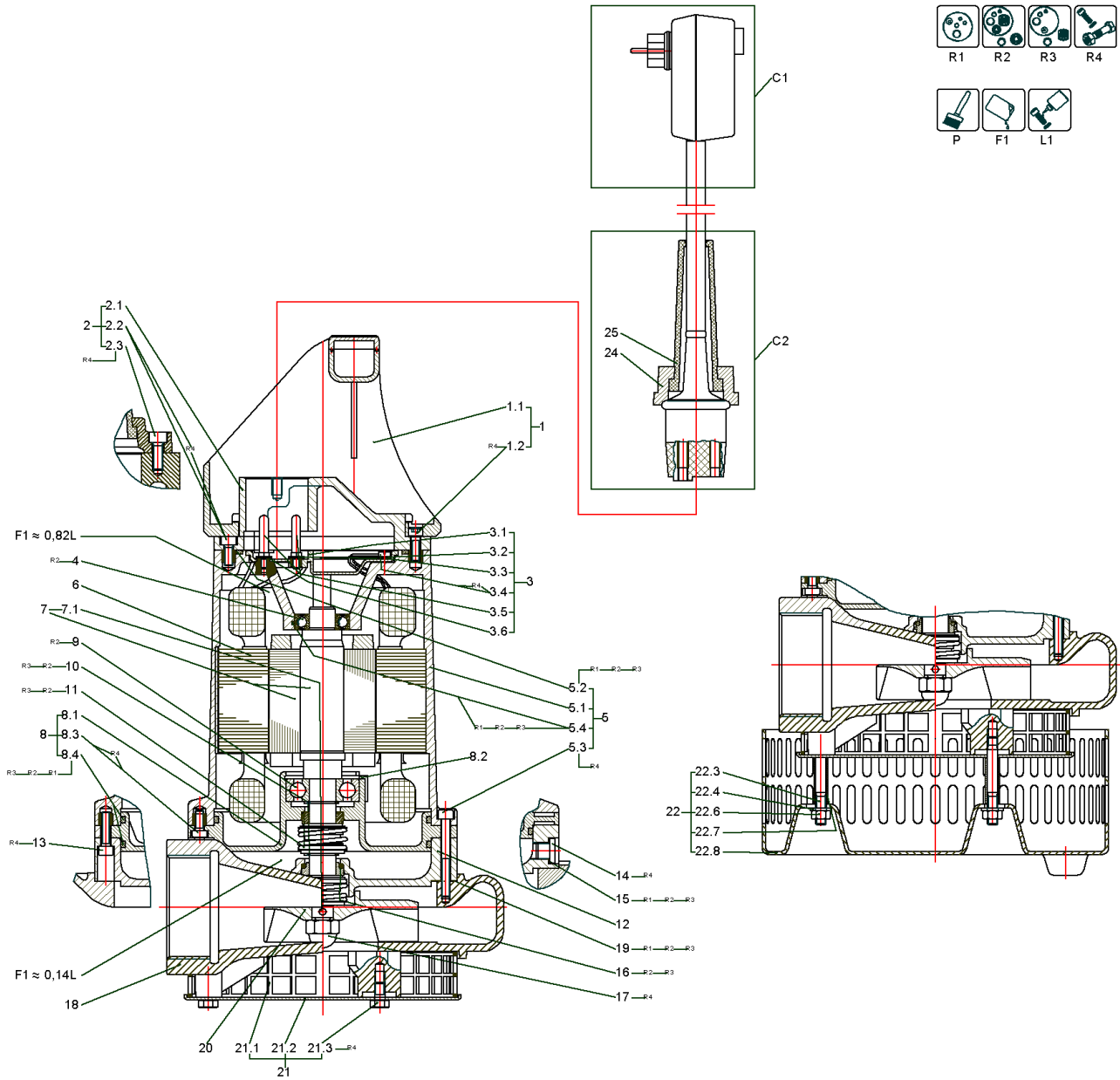

CONTRACTOR'S PUMP KS14 UNIT (6000086)

Item	Article no.	Description	Quantity
R1	6016267	Rep.Kit 1 KS8,9,12,14,15, F12 Vit	1
R2	6016308	Rep.Kit 2 KS8,9,12,14,15	1
R3	6016307	Rep.Kit 3 KS8,9,12,14,15	1
R4	6016132	Screws KS8,9,12,14,15 KE7;8;9, F12 KIT	1
P	6042254	PAINT SPRAY Pantone334	1
P	6042255	colour 2K-paint IV80 pantone334C 250ml	1
P	6023614	Ceram C0 black 100 ml KIT	1
P	6020579	Ceram C0 black 250 ml KIT	1
P	6023485	Ceram C0 Black 500ml Kit	1
P	6019157	Ceram C0 black 1000 ml KIT	1
F1	6025460	medical white oil 1L KIT	1
F1	6025461	medical white oil 5L KIT	1
L1	6080531	Loctite 243 5g flask VP:	1
L1	2096167	Loctite 243 50ml VP.	1

C1		PLUG	1
C2		cable for motor F12 / F13	1

1	6019566	handle 51.15480/1 plastics KIT	1
1.2		> screw M5x16 ISO4762 A2-70	1
1.1		> handle 51.15480/1 Akulon	1
2	6022949	motor cover D.95,8 51.17219 GG KIT	1
2.1		> motor cover D.95,8 51.17219 GG	1
2.2		> SCREW M5X12 ISO4762 A2-70	3
2.3		> screw M6x16 DIN912 A4 (10pc)	1
3	6001273	terminal board 54.3453 Makrolon KIT	1
3.1		> terminal board plastics Polycarbonat	1
3.5		> contact pin Ms	4
3.2		> lock washer 4 DIN7980 A4	1
3.3		> washer A4,3 DIN125 Ms	5
3.4		> screw M4x8 DIN84 Ms	1
3.6		> washer 4,3 DIN7349 Ms	1
4	6086141	ball bearing 6002 VP.	1
5	6021772	motor casing 52.3441 Al KIT	1

CONTRACTOR'S PUMP KS14 UNIT (6000086)

Item	Article no.	Description	Quantity
5.1		> motor casing 52.3441 Al	1
5.2		> o-ring ID.92,0x3,0 Viton	1
5.3		> screw M5x25 DIN912 A2-70	3
Note: für / for / pour KE			
5.3		> screw M5x45 ISO4762 A2-70	3
Note: für / for / pour KS			
5.4		> o-ring ID.32x1,78 Viton	1
Stator / stator / stator 50 Hz			
6	6023535	stator F12-2/6 230E 50Hz Ser11	1
6	6023532	stator F12-2/6 400 50Hz VN 01	1
6	6023533	stator F12-2/6 415 50Hz VN 01	1
6	6023534	stator F12-2/6 500 50Hz VN 01	1
alternativ / alternative / alternative			
6	6023531	stator F12-2/6 230 50Hz	1
Stator / stator / stator 60 Hz			
6	6023536	stator F12-2/6 230E 60Hz Ser11	1
6	6023537	stator F12-2/6 230/400 60Hz	1
7	6010006	rotor D.61,4x189 2/6 1.4021	1
8	6042497	bearing housing U 6050660 GG KIT	1
8.1		> lower bearing D.42H7 6050660 GG	1
8.2	6004669	> circlips 43,6x1,8 54.3438 FSt	1
8.3		> screw M5x12 DIN6912 A2-70	3
8.4		> o-ring ID.115,0x3,0 Viton -	2
9	6008975	ball bearing 6302	1
10	6002007	circlips 15x1 DIN471 FSt	2
11	6075396	mech shaft seal MG1/15-G64 BXPGG VP.	1
12	6013732	sealing casing D.125f6 53.3452 GG	1
alternativ / alternative / alternative			
12	6013724	sealing casing D.125f6 53.3452 GG/C0	1
12	6013730	sealing casing D.125f6 53.3452 GG/C1	1
13		screw M5x20 ISO4762 A2	3
14	6002430	screw plug G1/8 DIN908 A2	1
15	6048829	joint ring A10/13,5x1,5 DIN7603 PA(10pc)	1
16	6075381	mechanical shaft seal MG1/15-G4 Q1Q1PGG	1

CONTRACTOR'S PUMP KS14 UNIT (6000086)

Item	Article no.	Description	Quantity
		alternativ / alternative / alternative	
16	6003878	mechanical shaft seal MG1/15-G4 Q1Q1VGG	1
17	6002104	domet nut M10 DIN1587 A2	1
18	6012843	pump housing QG2 52.1116/1 GG	1
		alternativ / alternative / alternative	
18	6012841	pump housing QG2 52.1116/1 GG/CO	1
18	6012842	pump housing QG2 52.1116/1 GG/C1C1	1
18	6012687	pump housing QG2 52.17943 Abrasit	1
18	6024251	pump housing QG2 52.17943 Abrasit/CO	1
18	6012902	pump housing QG2 51.16783 1.4581	1
19	6048831	flat gasket D.125/155 ARAMID/NBR (10pc)	1
		Laufrad / Impeller / Roue 50Hz	
20	6022637	impeller-W D.103 54.14341 GG	1
		alternativ / alternative / alternative	
20	6024250	impeller-W D.103 54.14341 GG/CO	1
20	6022638	impeller-W D.103 54.14341 Abrasit	1
20	6022787	impeller-W D.103 54.14341 Abrasit/CO	1
20	6021652	impeller-W D.103 54.14341 1.4581	1
		Laufrad / Impeller / Roue 60Hz	
20	6014132	impeller-W D.94 54.14341 GG	1
		alternativ / alternative / alternative	
20	6024249	impeller-W D.94 54.14341 GG/CO	1
20	6022770	impeller-W D.94 54.14341 Abrasit	1
20	6022786	impeller-W D.94 54.14341 Abrasit/CO	1
20	6022636	impeller-W D.94 54.14341 1.4581	1
21	6001295	strainer 54.10534/1 1.4301 KIT	1
21.1		> strainer 26x155x2 1.4301	1
21.2		> base plate D.160x3 1,5 1.4301	1
21.3		> screw M6x10 ISO4017 A2-70	3
22	6032618	add on strainer KS 14/15 KIT	1
24	6004828	cable gland Akulon	1
25	6003824	cable peotection NBR 87x30 mm	1

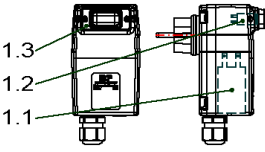
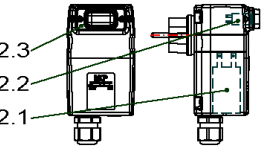
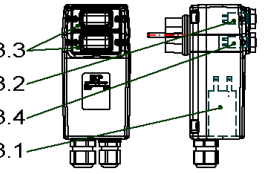
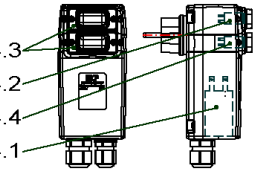
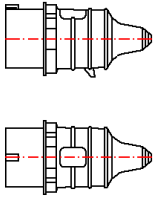
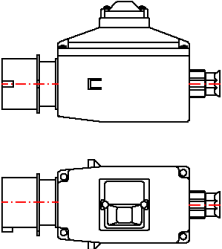
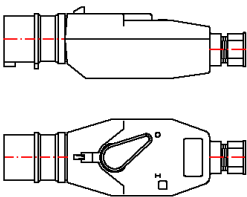
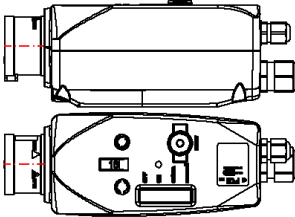
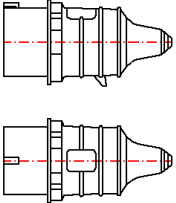
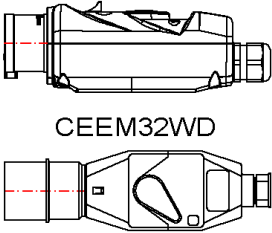
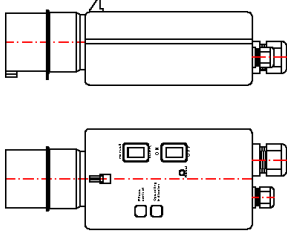
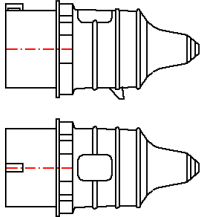
<p>1 MCP 6A-M-H-20μF ~ 230V</p>  <p>$I_N(230V / 50Hz) < 6A = 20\mu F$</p>	<p>2 MCP 10A-M-H-30μF ~ 230V</p>  <p>$I_N(230V / 50Hz) 6-10A = 30\mu F$</p>	<p>3 MCP 6A-M-HA-20μF ~ 230V</p>  <p>$I_N(230V / 50Hz) < 6A = 20\mu F$</p>	<p>4 MCP 10A-M-HA-30μF ~ 230V</p>  <p>$I_N(230V / 50Hz) 6-10A = 30\mu F$</p>
<p>5 CEE16A</p> 	<p>6 CEEM16W</p> 	<p>7 CEEM16WD</p> 	<p>8 MCP T4-HA-ROT-WSK CEE16-5PS</p> 
<p>9 CEE32A</p> 	<p>10 MCP 10-16A-T4-H-ROT CEE32-5PS</p>  <p>CEEM32WD</p>	<p>11 CEEM32WDSHA</p> 	<p>12 CEE63A</p> 

PLUG

Item	Article no.	Description	Quantity
		IN (230V / 50Hz) <6A - 20µF	
1	6072332	MCP 6A-M-H-20µF-CEE7/7 VP.	1
1.1	6071702	capacitor 400V 20µF MCP VP.	1
1.2	6071704	protection switch 6A MCP VP.	1
1.3	6071707	protecting cap MCP VP.	1
		IN (230V / 50Hz) 6-10A - 30µF	
2	6072330	MCP 10A-M-H-30µF-CEE7/7 VP.	1
2.1	6071703	capacitor 400V 30µF MCP VP.	1
2.2	6071705	protection switch 10A MCP VP.	1
2.3	6071707	protecting cap MCP VP.	1
		IN (230V / 50Hz) <6A - 20µF	
3	6072331	MCP 6A-M-HA-20µF-CEE7/7 VP.	1
3.1	6071702	capacitor 400V 20µF MCP VP.	1
3.2	6071704	protection switch 6A MCP VP.	1
3.3	6071707	protecting cap MCP VP.	2
3.4	6071706	switch on/out MCP VP.	1
		IN (230V / 50Hz) 6-10A - 30µF	
4	6072329	MCP 10A-M-HA-30µF-CEE7/7 VP	1
4.1	6071703	capacitor 400V 30µF MCP VP.	1
4.2	6071705	protection switch 10A MCP VP.	1
4.3	6071707	protecting cap MCP VP.	2
4.4	6071706	switch on/out MCP VP.	1
5	6003000	plug CEE16A/400V 60Hz/5P-11h	1
5	6003248	plug CEE16A/400V/4P-6H	1
5	6003009	plug CEE16A/400V/5P-6H	1
5	6039156	plug CEE16A/400V/5P-6H Phase inverter	1
5	6035231	plug CEE16A/400V/7P-6H	1
5	6003011	plug CEE16A/500V/5P-7H	1
6	6030883	plug MS400V5P CEE16A W 1,0-1,6A	1
6	6030884	plug MS400V5P CEE16A W 1,6-2,5A	1
6	6030888	plug MS400V5P CEE16A W 10,0-16,0A	1
6	6030885	plug MS400V5P CEE16A W 2,5-4,0A	1
6	6030886	plug MS400V5P CEE16A W 4,0-6,3A	1
6	6030887	plug MS400V5P CEE16A W 6,3-10,0A	1

PLUG

Item	Article no.	Description	Quantity
7	6032446	plug MS400V4P CEE16A WD 1,6-2,5A	1
7	6032447	plug MS400V4P CEE16A WD 12,5-16,0A	1
7	6032295	plug MS400V4P CEE16A WD 2,5-4,0A	1
7	6032289	plug MS400V4P CEE16A WD 4,0-6,3A	1
7	6032292	plug MS400V4P CEE16A WD 6,3-9,0A	1
7	6042190	plug MS400V5P CEE16A WDII 1,6-2,5A	1
7	6042194	plug MS400V5P CEE16A WDII 10,0-16,0A	1
7	6042191	plug MS400V5P CEE16A WDII 2,5-4,0A	1
7	6042192	plug MS400V5P CEE16A WDII 4,0-6,3A	1
7	6042193	plug MS400V5P CEE16A WDII 6,3-10,0A	1
7	6035911	plug MS400V5P CEE16A WD 9,0-12,5A	1
7	6003337	plug MS500V5P CEE16A WD 1,6-2,5A	1
7	6003336	plug MS500V5P CEE16A WD 2,5-4,0A	1
7	6003335	plug MS500V5P CEE16A WD 4,0-6,3A	1
7	6003334	plug MS500V5P CEE16A WD 6,3-9,0A	1
8	6072520	MCP 1,0-1,6A-T4-HA-ROT-WSK-CEE16-5PS VP.	1
8	6072521	MCP 1,6-2,4A-T4-HA-ROT-WSK-CEE16-5PS VP.	1
8	6072522	MCP 2,4-4,0A-T4-HA-ROT-WSK-CEE16-5PS VP.	1
8	6072523	MCP 4,0-6,0A-T4-HA-ROT-WSK-CEE16-5PS VP.	1
8	6072524	MCP 6,0-10A-T4-HA-ROT-WSK-CEE16-5PS VP.	1
8	6072525	MCP 9,0-12A-T4-HA-ROT-WSK-CEE16-5PS VP.	1
8	6072526	MCP 12-16A-T4-HA-ROT-WSK-CEE16-5PS VP.	1
9	6003267	plug CEE32A/400V/4P-6H	1
9	6039155	plug CEE32A/400V/5P-6H Phase inverter	1
9	6035895	plug CEE32A/500V/4P-7H AM-Top	1
9	6003010	plug CEE32A/500V/5P-7H	1
10	6072370	MCP 400V 1,6-2,5A-T4-H-ROT-CEE32-5PS VP.	1
10	6072369	MCP 400V 2,5-4,0A-T4-H-ROT-CEE32-5PS VP.	1
10	6072371	MCP 400V 4,0-6,3A-T4-H-ROT-CEE32-5PS VP.	1
10	6072398	MCP 400V 6,3-10A-T4-H-ROT-CEE32-5PS VP.	1
10	6072519	MCP 400V 10-16A-T4-H-ROT-CEE32-5PS VP.	1
10	6072399	MCP 400V 16-20A-T4-H-ROT-CEE32-5PS VP.	1
10	6072518	MCP 400V 20-25A-T4-H-ROT-CEE32-5PS VP.	1
10	6037649	plug.MS500V4P CEE32A WD 2,5-4,0A	1

PLUG

Item	Article no.	Description	Quantity
10	6041268	plug MS500V4P CEE32A WD 4,0-6,3A	1
10	6035244	plug MS500V5P CEE32A WD 1,6-2,5A	1
10	6034700	plug MS500V5P CEE32A WD 2,5-4,0A	1
10	6041556	plug MS500V5P CEE32A WD 4,0-6,3A	1
10	6002701	plug MS500V5P CEE32A WD 9,0-12,5A	1
10	6002700	plug MS500V5P CEE32A WD 12,5-16,0A	1
11	6003241	plug MS400V5P CEE32A WDSHA 10,0-14,0A	1
11	6003266	plug MS400V5P CEE32A WDSHA 3,7-5,5A	1
11	6003265	plug MS400V5P CEE32A WDSHA 5,5-8,0A	1
11	6003264	plug MS400V5P CEE32A WDSHA 8,0-11,5A	1
12	6003012	plug CEE63A/400V/5P-6H/IP67	1

cable for motor F12 / F13

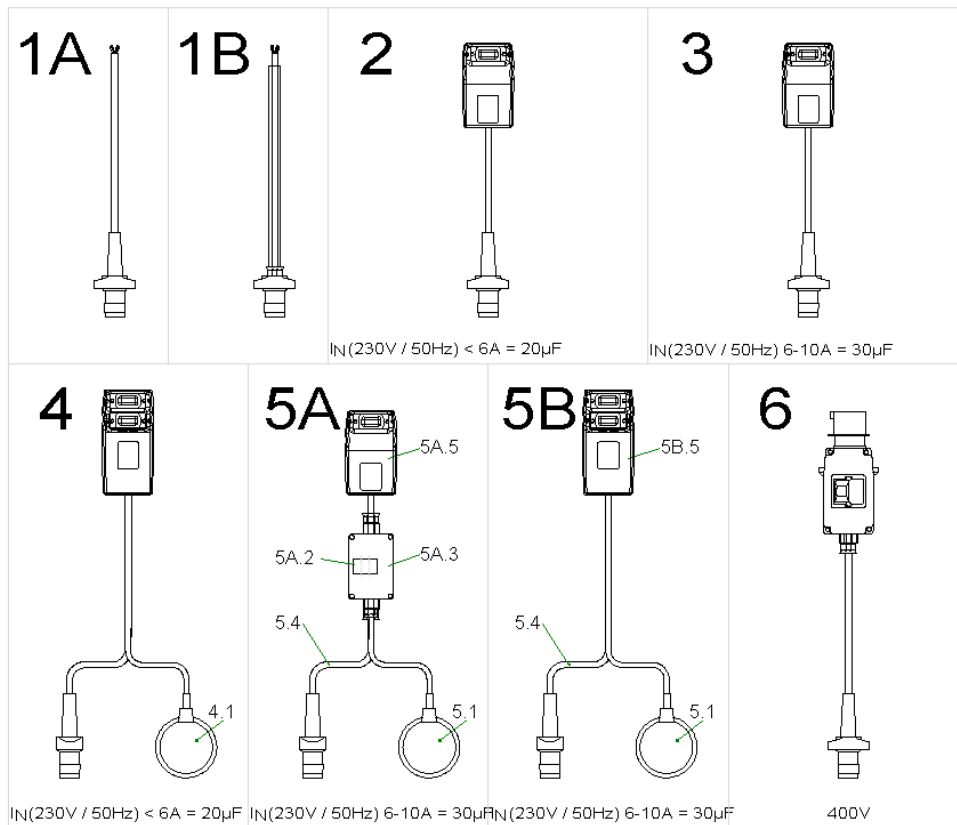

cable for motor F12 / F13

Item	Article no.	Description	Quantity
1A	6072559	cable 5m H07 4G1,5/coupling VP.	1
1A	6072560	cable 10m H07 4G1,5/coupling VP.	1
1A	6072561	cable 20m H07 4G1,5/coupling VP.	1
1A	6072562	cable 30m H07 4G1,5/coupling VP.	1
1A	6072563	cable 40m H07 4G1,5/coupling VP.	1
1A	6087533	cable 40m H07 4G1,5/coupling VP.	1
1B	6072564	cable 10m H07 4G1,5/coupl./hose VP. IN (230V / 50Hz) <6A - 20µF	1
2	6072565	switch box MCP 6A H 5M VP.	1
2	6072566	switch box MCP 6A H 10M VP.	1
2	6072567	switch box MCP 6A H 20M VP. IN (230V / 50Hz) 6-10A - 30µF	1
3	6072568	switch box MCP 10A H 5M VP.	1
3	6072569	switch box MCP 10A H 10M VP.	1
3	6072570	switch box MCP 10A H 20M VP. IN (230V / 50Hz) <6A - 20µF	1
4	6072571	switch box MCP 6A HA 5M VP.	1
4	6072572	switch box MCP 6A HA 10M VP.	1
4.1	6072582	float switch S-PS 10A 250V 10m NO VP	1
4	6072576	switch box MCP 6A HA 20M VP.	1
4.1	6072583	float switch S-PS 10A 250V 20m NO VP IN (230V / 50Hz) 6-10A - 30µF	1
5A		on request	1
5B	6072577	switch box MCP 10A HA 10M	1
5.1	6072582	float switch S-PS 10A 250V 10m NO VP	1
5A.2	6003341	contactor 5,5 kW 230 V, 50 Hz	1
5A.3	6031509	blank casing KS12/15ES KIT	1
5.4	6072560	cable 10m H07 4G1,5/coupling VP.	1
5A.5	6072330	MCP 10A-M-H-30µF-CEE7/7 VP.	1
5B.5	6072329	MCP 10A-M-HA-30µF-CEE7/7 VP für / for / pour 400V	1
6	6023991	switch box CEEM16W 2,5A, 10m SVA	1
6	6001253	switch box CEEM16W 4A, 10m SVA	1
6	6023992	switch box CEEM16W 6,3A, 20m SVA	1

CONTRACTOR'S PUMP KS 14GG UNIT (6000087)

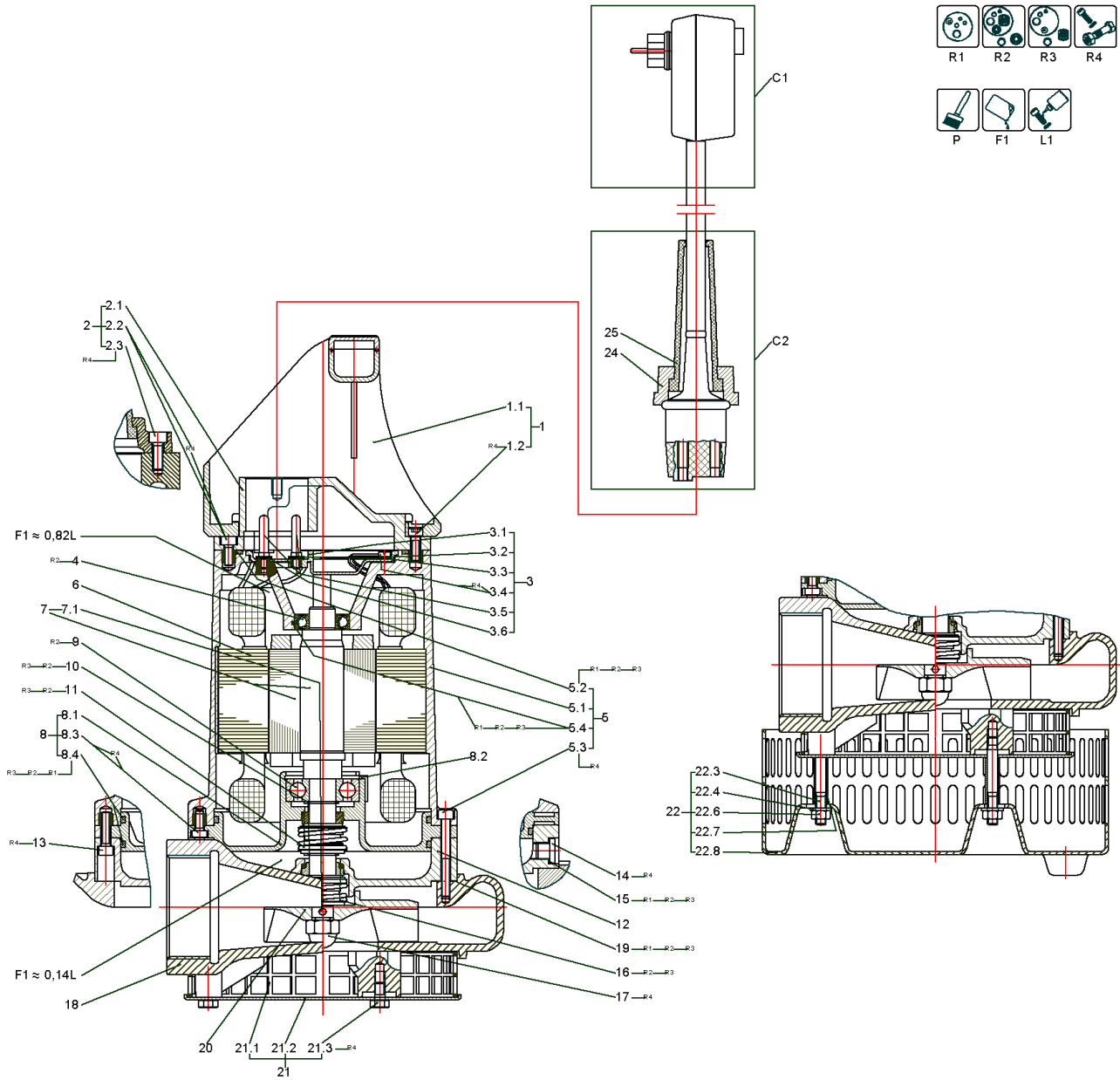

CONTRACTOR'S PUMP KS 14GG UNIT (6000087)

Item	Article no.	Description	Quantity
R1	6016267	Rep.Kit 1 KS8,9,12,14,15, F12 Vit	1
R2	6016308	Rep.Kit 2 KS8,9,12,14,15	1
R3	6016307	Rep.Kit 3 KS8,9,12,14,15	1
R4	6016132	Screws KS8,9,12,14,15 KE7;8;9, F12 KIT	1
P	6042254	PAINT SPRAY Pantone334	1
P	6042255	colour 2K-paint IV80 pantone334C 250ml	1
P	6023614	Ceram C0 black 100 ml KIT	1
P	6020579	Ceram C0 black 250 ml KIT	1
P	6023485	Ceram C0 Black 500ml Kit	1
P	6019157	Ceram C0 black 1000 ml KIT	1
F1	6025460	medical white oil 1L KIT	1
F1	6025461	medical white oil 5L KIT	1
L1	6080531	Loctite 243 5g flask VP:	1
L1	2096167	Loctite 243 50ml VP.	1

C1		PLUG	1
C2		cable for motor F12 / F13	1

1	6019566	handle 51.15480/1 plastics KIT	1
1.2		> screw M5x16 ISO4762 A2-70	1
1.1		> handle 51.15480/1 Akulon	1
2	6022949	motor cover D.95,8 51.17219 GG KIT	1
2.1		> motor cover D.95,8 51.17219 GG	1
2.2		> SCREW M5X12 ISO4762 A2-70	3
2.3		> screw M6x16 DIN912 A4 (10pc)	1
3	6001273	terminal board 54.3453 Makrolon KIT	1
3.1		> terminal board plastics Polycarbonat	1
3.5		> contact pin Ms	4
3.2		> lock washer 4 DIN7980 A4	1
3.3		> washer A4,3 DIN125 Ms	5
3.4		> screw M4x8 DIN84 Ms	1
3.6		> washer 4,3 DIN7349 Ms	1
4	6086141	ball bearing 6002 VP.	1
5	6022378	motor casing 52.2924/1E GG KIT	1

CONTRACTOR'S PUMP KS 14GG UNIT (6000087)

Item	Article no.	Description	Quantity
5.1		> motor casing 52.2924/1 GG	1
5.2		> o-ring ID.92,0x3,0 Viton	1
5.3		> screw M5x25 DIN912 A2-70	3
5.3		> screw M5x45 ISO4762 A2-70	3
Note: für / for / pour KS			
5.4		> o-ring ID.32x1,78 Viton	1
		Stator / stator / stator 50 Hz	
6	6023535	stator F12-2/6 230E 50Hz Ser11	1
6	6023532	stator F12-2/6 400 50Hz VN 01	1
6	6023533	stator F12-2/6 415 50Hz VN 01	1
6	6023534	stator F12-2/6 500 50Hz VN 01	1
		alternativ / alternative / alternative	
6	6023531	stator F12-2/6 230 50Hz	1
		Stator / stator / stator 60 Hz	
6	6023536	stator F12-2/6 230E 60Hz Ser11	1
6	6023537	stator F12-2/6 230/400 60Hz	1
7	6010006	rotor D.61,4x189 2/6 1.4021	1
8	6042497	bearing housing U 6050660 GG KIT	1
8.1		> lower bearing D.42H7 6050660 GG	1
8.2	6004669	> circlips 43,6x1,8 54.3438 FSt	1
8.3		> screw M5x12 DIN6912 A2-70	3
8.4		> o-ring ID.115,0x3,0 Viton -	2
9	6008975	ball bearing 6302	1
10	6002007	circlips 15x1 DIN471 FSt	2
11	6075396	mech shaft seal MG1/15-G64 BXPGG VP.	1
12	6013732	sealing casing D.125f6 53.3452 GG	1
		alternativ / alternative / alternative	
12	6013724	sealing casing D.125f6 53.3452 GG/C0	1
12	6013730	sealing casing D.125f6 53.3452 GG/C1	1
13		screw M5x20 ISO4762 A2	3
14	6002430	screw plug G1/8 DIN908 A2	1
15	6048829	joint ring A10/13,5x1,5 DIN7603 PA(10pc)	1
16	6075381	mechanical shaft seal MG1/15-G4 Q1Q1PGG	1
		alternativ / alternative / alternative	

CONTRACTOR'S PUMP KS 14GG UNIT (6000087)

Item	Article no.	Description	Quantity
16	6003878	mechanical shaft seal MG1/15-G4 Q1Q1VGG	1
17	6002104	domet nut M10 DIN1587 A2	1
18	6012843	pump housing QG2 52.1116/1 GG alternativ / alternative / alternative	1
18	6012841	pump housing QG2 52.1116/1 GG/C0	1
18	6012842	pump housing QG2 52.1116/1 GG/C1C1	1
18	6012687	pump housing QG2 52.17943 Abrasit	1
18	6024251	pump housing QG2 52.17943 Abrasit/C0	1
18	6012902	pump housing QG2 51.16783 1.4581	1
19	6048831	flat gasket D.125/155 ARAMID/NBR (10pc) Laufrad / Impeller / Roue 50Hz	1
20	6022637	impeller-W D.103 54.14341 GG alternativ / alternative / alternative	1
20	6024250	impeller-W D.103 54.14341 GG/C0	1
20	6022638	impeller-W D.103 54.14341 Abrasit	1
20	6022787	impeller-W D.103 54.14341 Abrasit/CO	1
20	6021652	impeller-W D.103 54.14341 1.4581 Laufrad / Impeller / Roue 60Hz	1
20	6014132	impeller-W D.94 54.14341 GG alternativ / alternative / alternative	1
20	6024249	impeller-W D.94 54.14341 GG/C0	1
20	6022770	impeller-W D.94 54.14341 Abrasit	1
20	6022786	impeller-W D.94 54.14341 Abrasit/CO	1
20	6022636	impeller-W D.94 54.14341 1.4581	1
21	6001295	strainer 54.10534/1 1.4301 KIT	1
21.1		> strainer 26x155x2 1.4301	1
21.2		> base plate D.160x3 1,5 1.4301	1
21.3		> screw M6x10 ISO4017 A2-70	3
22	6032618	add on strainer KS 14/15 KIT	1
24	6004828	cable gland Akulon	1
25	6003824	cable peotection NBR 87x30 mm	1

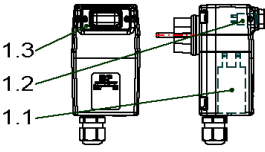
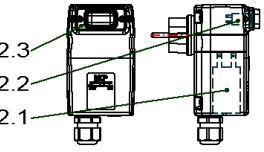
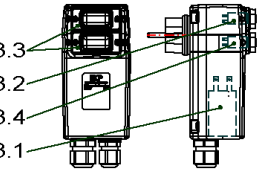
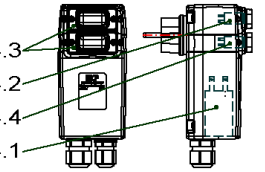
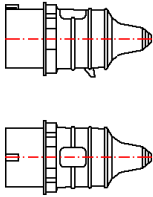
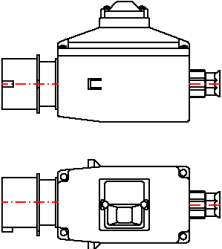
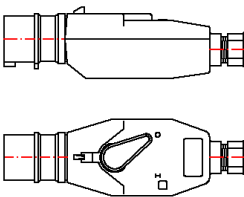
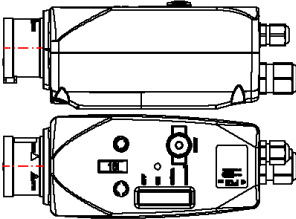
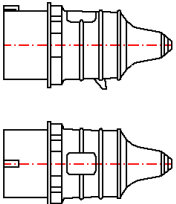
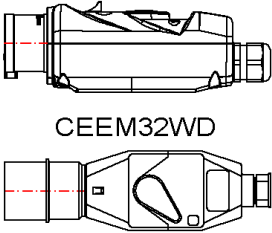
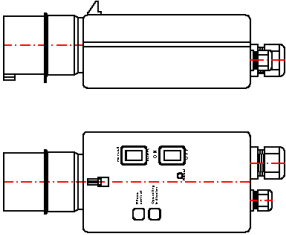
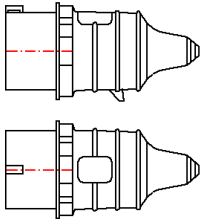
<p>1 MCP 6A-M-H-20μF ~ 230V</p>  <p>$I_N(230V / 50Hz) < 6A = 20\mu F$</p>	<p>2 MCP 10A-M-H-30μF ~ 230V</p>  <p>$I_N(230V / 50Hz) 6-10A = 30\mu F$</p>	<p>3 MCP 6A-M-HA-20μF ~ 230V</p>  <p>$I_N(230V / 50Hz) < 6A = 20\mu F$</p>	<p>4 MCP 10A-M-HA-30μF ~ 230V</p>  <p>$I_N(230V / 50Hz) 6-10A = 30\mu F$</p>
<p>5 CEE16A</p> 	<p>6 CEEM16W</p> 	<p>7 CEEM16WD</p> 	<p>8 MCP T4-HA-ROT-WSK CEE16-5PS</p> 
<p>9 CEE32A</p> 	<p>10 MCP 10-16A-T4-H-ROT CEE32-5PS</p>  <p>CEEM32WD</p>	<p>11 CEEM32WDSHA</p> 	<p>12 CEE63A</p> 

PLUG

Item	Article no.	Description	Quantity
		IN (230V / 50Hz) <6A - 20μF	
1	6072332	MCP 6A-M-H-20μF-CEE7/7 VP.	1
1.1	6071702	capacitor 400V 20μF MCP VP.	1
1.2	6071704	protection switch 6A MCP VP.	1
1.3	6071707	protecting cap MCP VP.	1
		IN (230V / 50Hz) 6-10A - 30μF	
2	6072330	MCP 10A-M-H-30μF-CEE7/7 VP.	1
2.1	6071703	capacitor 400V 30μF MCP VP.	1
2.2	6071705	protection switch 10A MCP VP.	1
2.3	6071707	protecting cap MCP VP.	1
		IN (230V / 50Hz) <6A - 20μF	
3	6072331	MCP 6A-M-HA-20μF-CEE7/7 VP.	1
3.1	6071702	capacitor 400V 20μF MCP VP.	1
3.2	6071704	protection switch 6A MCP VP.	1
3.3	6071707	protecting cap MCP VP.	2
3.4	6071706	switch on/out MCP VP.	1
		IN (230V / 50Hz) 6-10A - 30μF	
4	6072329	MCP 10A-M-HA-30μF-CEE7/7 VP	1
4.1	6071703	capacitor 400V 30μF MCP VP.	1
4.2	6071705	protection switch 10A MCP VP.	1
4.3	6071707	protecting cap MCP VP.	2
4.4	6071706	switch on/out MCP VP.	1
5	6003000	plug CEE16A/400V 60Hz/5P-11h	1
5	6003248	plug CEE16A/400V/4P-6H	1
5	6003009	plug CEE16A/400V/5P-6H	1
5	6039156	plug CEE16A/400V/5P-6H Phase inverter	1
5	6035231	plug CEE16A/400V/7P-6H	1
5	6003011	plug CEE16A/500V/5P-7H	1
6	6030883	plug MS400V5P CEE16A W 1,0-1,6A	1
6	6030884	plug MS400V5P CEE16A W 1,6-2,5A	1
6	6030888	plug MS400V5P CEE16A W 10,0-16,0A	1
6	6030885	plug MS400V5P CEE16A W 2,5-4,0A	1
6	6030886	plug MS400V5P CEE16A W 4,0-6,3A	1
6	6030887	plug MS400V5P CEE16A W 6,3-10,0A	1

PLUG

Item	Article no.	Description	Quantity
7	6032446	plug MS400V4P CEE16A WD 1,6-2,5A	1
7	6032447	plug MS400V4P CEE16A WD 12,5-16,0A	1
7	6032295	plug MS400V4P CEE16A WD 2,5-4,0A	1
7	6032289	plug MS400V4P CEE16A WD 4,0-6,3A	1
7	6032292	plug MS400V4P CEE16A WD 6,3-9,0A	1
7	6042190	plug MS400V5P CEE16A WDII 1,6-2,5A	1
7	6042194	plug MS400V5P CEE16A WDII 10,0-16,0A	1
7	6042191	plug MS400V5P CEE16A WDII 2,5-4,0A	1
7	6042192	plug MS400V5P CEE16A WDII 4,0-6,3A	1
7	6042193	plug MS400V5P CEE16A WDII 6,3-10,0A	1
7	6035911	plug MS400V5P CEE16A WD 9,0-12,5A	1
7	6003337	plug MS500V5P CEE16A WD 1,6-2,5A	1
7	6003336	plug MS500V5P CEE16A WD 2,5-4,0A	1
7	6003335	plug MS500V5P CEE16A WD 4,0-6,3A	1
7	6003334	plug MS500V5P CEE16A WD 6,3-9,0A	1
8	6072520	MCP 1,0-1,6A-T4-HA-ROT-WSK-CEE16-5PS VP.	1
8	6072521	MCP 1,6-2,4A-T4-HA-ROT-WSK-CEE16-5PS VP.	1
8	6072522	MCP 2,4-4,0A-T4-HA-ROT-WSK-CEE16-5PS VP.	1
8	6072523	MCP 4,0-6,0A-T4-HA-ROT-WSK-CEE16-5PS VP.	1
8	6072524	MCP 6,0-10A-T4-HA-ROT-WSK-CEE16-5PS VP.	1
8	6072525	MCP 9,0-12A-T4-HA-ROT-WSK-CEE16-5PS VP.	1
8	6072526	MCP 12-16A-T4-HA-ROT-WSK-CEE16-5PS VP.	1
9	6003267	plug CEE32A/400V/4P-6H	1
9	6039155	plug CEE32A/400V/5P-6H Phase inverter	1
9	6035895	plug CEE32A/500V/4P-7H AM-Top	1
9	6003010	plug CEE32A/500V/5P-7H	1
10	6072370	MCP 400V 1,6-2,5A-T4-H-ROT-CEE32-5PS VP.	1
10	6072369	MCP 400V 2,5-4,0A-T4-H-ROT-CEE32-5PS VP.	1
10	6072371	MCP 400V 4,0-6,3A-T4-H-ROT-CEE32-5PS VP.	1
10	6072398	MCP 400V 6,3-10A-T4-H-ROT-CEE32-5PS VP.	1
10	6072519	MCP 400V 10-16A-T4-H-ROT-CEE32-5PS VP.	1
10	6072399	MCP 400V 16-20A-T4-H-ROT-CEE32-5PS VP.	1
10	6072518	MCP 400V 20-25A-T4-H-ROT-CEE32-5PS VP.	1
10	6037649	plug.MS500V4P CEE32A WD 2,5-4,0A	1

PLUG

Item	Article no.	Description	Quantity
10	6041268	plug MS500V4P CEE32A WD 4,0-6,3A	1
10	6035244	plug MS500V5P CEE32A WD 1,6-2,5A	1
10	6034700	plug MS500V5P CEE32A WD 2,5-4,0A	1
10	6041556	plug MS500V5P CEE32A WD 4,0-6,3A	1
10	6002701	plug MS500V5P CEE32A WD 9,0-12,5A	1
10	6002700	plug MS500V5P CEE32A WD 12,5-16,0A	1
11	6003241	plug MS400V5P CEE32A WDSHA 10,0-14,0A	1
11	6003266	plug MS400V5P CEE32A WDSHA 3,7-5,5A	1
11	6003265	plug MS400V5P CEE32A WDSHA 5,5-8,0A	1
11	6003264	plug MS400V5P CEE32A WDSHA 8,0-11,5A	1
12	6003012	plug CEE63A/400V/5P-6H/IP67	1

cable for motor F12 / F13

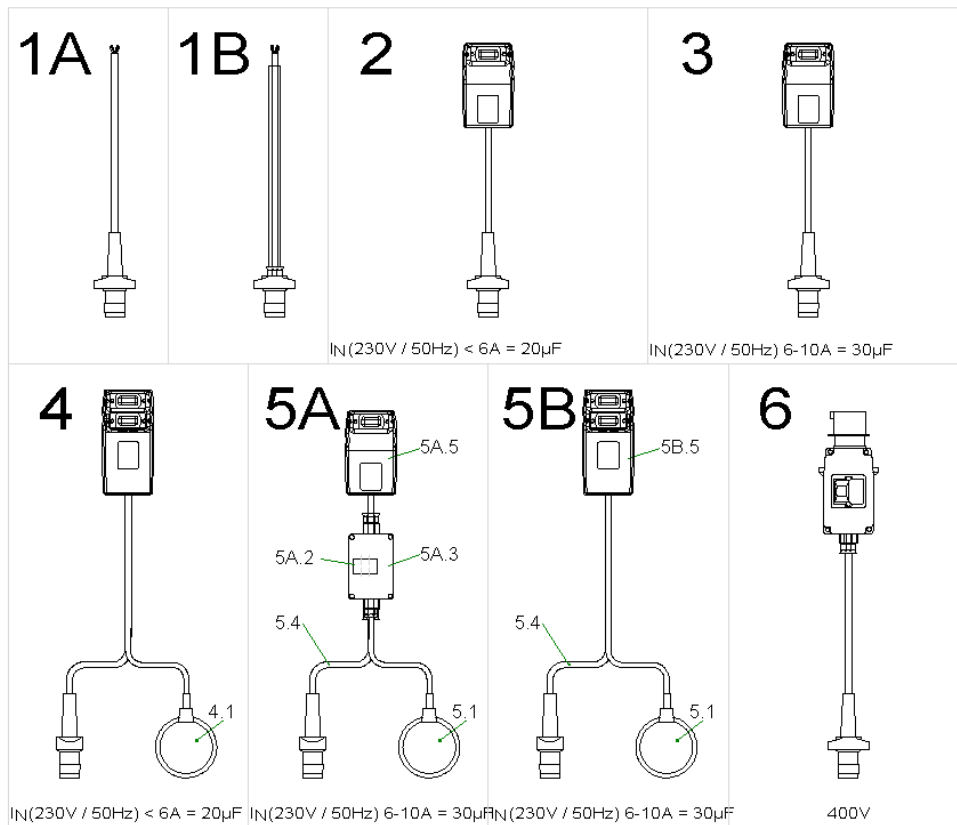

cable for motor F12 / F13

Item	Article no.	Description	Quantity
1A	6072559	cable 5m H07 4G1,5/coupling VP.	1
1A	6072560	cable 10m H07 4G1,5/coupling VP.	1
1A	6072561	cable 20m H07 4G1,5/coupling VP.	1
1A	6072562	cable 30m H07 4G1,5/coupling VP.	1
1A	6072563	cable 40m H07 4G1,5/coupling VP.	1
1A	6087533	cable 40m H07 4G1,5/coupling VP.	1
1B	6072564	cable 10m H07 4G1,5/coupl./hose VP. IN (230V / 50Hz) <6A - 20μF	1
2	6072565	switch box MCP 6A H 5M VP.	1
2	6072566	switch box MCP 6A H 10M VP.	1
2	6072567	switch box MCP 6A H 20M VP. IN (230V / 50Hz) 6-10A - 30μF	1
3	6072568	switch box MCP 10A H 5M VP.	1
3	6072569	switch box MCP 10A H 10M VP.	1
3	6072570	switch box MCP 10A H 20M VP. IN (230V / 50Hz) <6A - 20μF	1
4	6072571	switch box MCP 6A HA 5M VP.	1
4	6072572	switch box MCP 6A HA 10M VP.	1
4.1	6072582	float switch S-PS 10A 250V 10m NO VP	1
4	6072576	switch box MCP 6A HA 20M VP.	1
4.1	6072583	float switch S-PS 10A 250V 20m NO VP IN (230V / 50Hz) 6-10A - 30μF	1
5A		on request	1
5B	6072577	switch box MCP 10A HA 10M	1
5.1	6072582	float switch S-PS 10A 250V 10m NO VP	1
5A.2	6003341	contactor 5,5 kW 230 V, 50 Hz	1
5A.3	6031509	blank casing KS12/15ES KIT	1
5.4	6072560	cable 10m H07 4G1,5/coupling VP.	1
5A.5	6072330	MCP 10A-M-H-30μF-CEE7/7 VP.	1
5B.5	6072329	MCP 10A-M-HA-30μF-CEE7/7 VP für / for / pour 400V	1
6	6023991	switch box CEEM16W 2,5A, 10m SVA	1
6	6001253	switch box CEEM16W 4A, 10m SVA	1
6	6023992	switch box CEEM16W 6,3A, 20m SVA	1

CONTRACTOR'S PUMP KS15 UNIT (6000088)

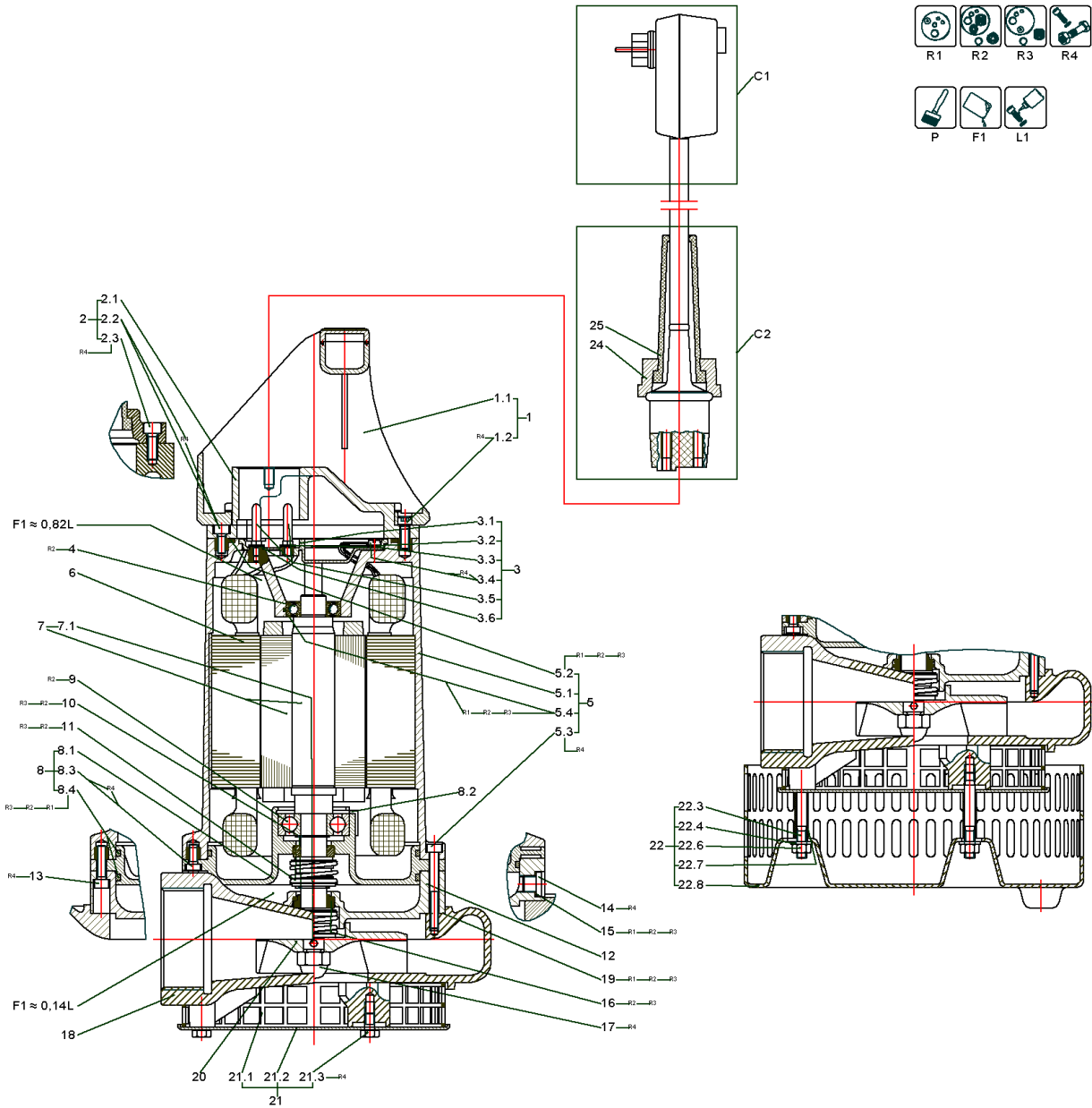

CONTRACTOR'S PUMP KS15 UNIT (6000088)

Item	Article no.	Description	Quantity
R1	6016267	Rep.Kit 1 KS8,9,12,14,15, F12 Vit	1
R2	6016308	Rep.Kit 2 KS8,9,12,14,15	1
R3	6016307	Rep.Kit 3 KS8,9,12,14,15	1
R4	6016132	Screws KS8,9,12,14,15 KE7;8;9, F12 KIT	1
P	6042254	PAINT SPRAY Pantone334	1
P	6042255	colour 2K-paint IV80 pantone334C 250ml	1
P	6023614	Ceram C0 black 100 ml KIT	1
P	6020579	Ceram C0 black 250 ml KIT	1
P	6023485	Ceram C0 Black 500ml Kit	1
P	6019157	Ceram C0 black 1000 ml KIT	1
F1	6025460	medical white oil 1L KIT	1
F1	6025461	medical white oil 5L KIT	1
L1	6080531	Loctite 243 5g flask VP:	1
L1	2096167	Loctite 243 50ml VP.	1

C1		PLUG	1
C2		cable for motor F12 / F13	1

1	6019566	handle 51.15480/1 plastics KIT	1
1.2		> screw M5x16 ISO4762 A2-70	1
1.1		> handle 51.15480/1 Akulon	1
2	6022949	motor cover D.95,8 51.17219 GG KIT	1
2.1		> motor cover D.95,8 51.17219 GG	1
2.2		> SCREW M5X12 ISO4762 A2-70	3
2.3		> screw M6x16 DIN912 A4 (10pc)	1
3	6001273	terminal board 54.3453 Makrolon KIT	1
3.1		> terminal board plastics Polycarbonat	1
3.5		> contact pin Ms	4
3.2		> lock washer 4 DIN7980 A4	1
3.3		> washer A4,3 DIN125 Ms	5
3.4		> screw M4x8 DIN84 Ms	1
3.6		> washer 4,3 DIN7349 Ms	1
4	6086141	ball bearing 6002 VP.	1
5.1	6013837	motor casing 52.2889 Al	1

CONTRACTOR'S PUMP KS15 UNIT (6000088)

Item	Article no.	Description	Quantity
5.2		o-ring ID.92,0x3,0 Viton	1
5.3		screw M5x45 ISO4762 A2-70	3
5.4		o-ring ID.32x1,78 Viton	1
		Stator / stator / stator 50 Hz	
6	6023541	stator F12-2/9 230E 50Hz Ser11	1
6	6023538	stator F12-2/9 230/400 50Hz	1
6	6023539	stator F12-2/9 415 50Hz VN 01	1
6	6023540	stator F12-2/9 500 50Hz VN 01	1
6	6061716	stator F12-2/9 690 50Hz	1
		Stator / stator / stator 60 Hz	
6	6023542	stator F12-2/9 220/380 60Hz	1
7	6010002	rotor D.61,4x225 2/9 1.4021	1
8	6042497	bearing housing U 6050660 GG KIT	1
8.1		> lower bearing D.42H7 6050660 GG	1
8.2	6004669	> circlips 43,6x1,8 54.3438 FSt	1
8.3		> screw M5x12 DIN6912 A2-70	3
8.4		> o-ring ID.115,0x3,0 Viton -	2
9	6008975	ball bearing 6302	1
10	6002007	circlips 15x1 DIN471 FSt	2
11	6075396	mech shaft seal MG1/15-G64 BXPGG VP.	1
12	6013732	sealing casing D.125f6 53.3452 GG	1
		alternativ / alternative / alternative	
12	6013724	sealing casing D.125f6 53.3452 GG/C0	1
12	6013730	sealing casing D.125f6 53.3452 GG/C1	1
13		screw M5x20 ISO4762 A2	3
14	6002430	screw plug G1/8 DIN908 A2	1
15	6048829	joint ring A10/13,5x1,5 DIN7603 PA(10pc)	1
16	6075381	mechanical shaft seal MG1/15-G4 Q1Q1PGG	1
		alternativ / alternative / alternative	
16	6003878	mechanical shaft seal MG1/15-G4 Q1Q1VGG	1
17	6002104	domet nut M10 DIN1587 A2	1
18	6012843	pump housing QG2 52.1116/1 GG	1
		alternativ / alternative / alternative	
18	6012841	pump housing QG2 52.1116/1 GG/C0	1

CONTRACTOR'S PUMP KS15 UNIT (6000088)

Item	Article no.	Description	Quantity
18	6012842	pump housing QG2 52.1116/1 GG/C1C1	1
18	6012687	pump housing QG2 52.17943 Abrasit	1
18	6024251	pump housing QG2 52.17943 Abrasit/CO	1
18	6012902	pump housing QG2 51.16783 1.4581	1
19	6048831	flat gasket D.125/155 ARAMID/NBR (10pc)	1
		Laufrad / Impeller / Roue 50Hz	
20	6014039	impeller-W D.119 53.1047 GG	1
		alternativ / alternative / alternative	
20	6014046	impeller-W D.119 54.1047 GG/CO	1
20	6021687	impeller-W D.119 54.1047 GG/C1	1
20	6014149	impeller-W D.119 53.18032 Abrasit	1
20	6024247	impeller-W D.119 53.18032 Abrasit/CO	1
20	6014038	impeller-W D.119 53.1047 1.4581	1
20	6014047	impeller-W D.119 54.1047 1.4581/CO	1
		Laufrad / Impeller / Roue 60Hz	
20	6022660	impeller-W D.109 53.1047 GG	1
		alternativ / alternative / alternative	
20	6022663	impeller-W D.109 54.1047 GG/CO	1
20	6022662	impeller-W D.109 54.1047 GG/C1	1
20	6022664	impeller-W D.109 53.18032 Abrasit	1
20	6024248	impeller-W D.109 54.18032 Abrasit/CO	1
20	6022661	impeller-W D.109 53.1047 1.4581	1
20	6022659	impeller-W D.109 54.1047 1.4581/CO	1
21	6001295	strainer 54.10534/1 1.4301 KIT	1
21.1		> strainer 26x155x2 1.4301	1
21.2		> base plate D.160x3 1,5 1.4301	1
21.3		> screw M6x10 ISO4017 A2-70	3
22	6032618	add on strainer KS 14/15 KIT	1
24	6004828	cable gland Akulon	1
25	6003824	cable peotection NBR 87x30 mm	1

		Sonderausführung 4-polig / specialdesign 4-pole / exécution spéciale à	
5.1	6013841	motor casing 52.3441 Al	1
6	6023507	stator F12-4/6 400 50Hz VN 01	1

CONTRACTOR'S PUMP KS15 UNIT (6000088)

Item	Article no.	Description	Quantity
7	6010026	rotor D.69,4x189 4/6 1.4021	1

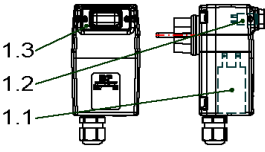
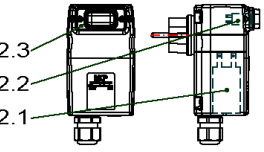
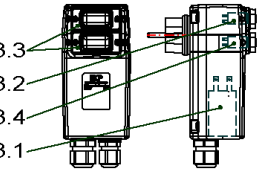
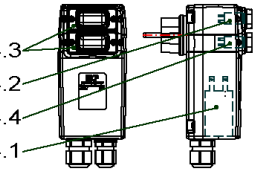
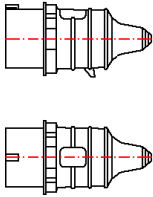
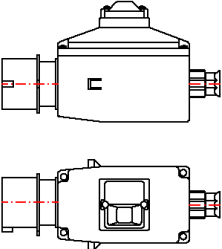
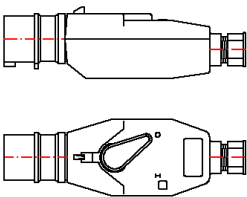
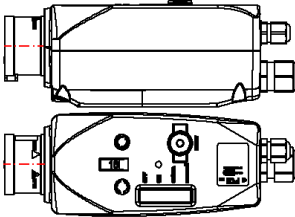
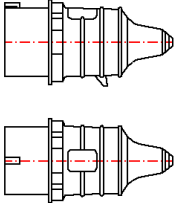
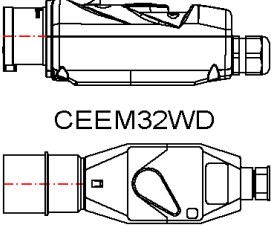
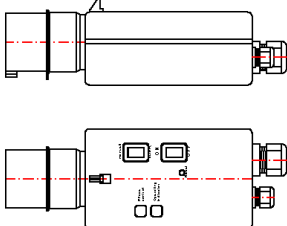
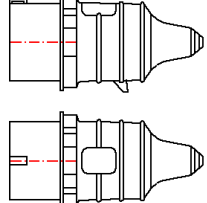
<p>1 MCP 6A-M-H-20μF ~ 230V</p>  <p>$I_N(230V / 50Hz) < 6A = 20\mu F$</p>	<p>2 MCP 10A-M-H-30μF ~ 230V</p>  <p>$I_N(230V / 50Hz) 6-10A = 30\mu F$</p>	<p>3 MCP 6A-M-HA-20μF ~ 230V</p>  <p>$I_N(230V / 50Hz) < 6A = 20\mu F$</p>	<p>4 MCP 10A-M-HA-30μF ~ 230V</p>  <p>$I_N(230V / 50Hz) 6-10A = 30\mu F$</p>
<p>5 CEE16A</p> 	<p>6 CEEM16W</p> 	<p>7 CEEM16WD</p> 	<p>8 MCP T4-HA-ROT-WSK CEE16-5PS</p> 
<p>9 CEE32A</p> 	<p>10 MCP 10-16A-T4-H-ROT CEE32-5PS</p>  <p>CEEM32WD</p>	<p>11 CEEM32WDSHA</p> 	<p>12 CEE63A</p> 

PLUG

Item	Article no.	Description	Quantity
		IN (230V / 50Hz) <6A - 20µF	
1	6072332	MCP 6A-M-H-20µF-CEE7/7 VP.	1
1.1	6071702	capacitor 400V 20µF MCP VP.	1
1.2	6071704	protection switch 6A MCP VP.	1
1.3	6071707	protecting cap MCP VP.	1
		IN (230V / 50Hz) 6-10A - 30µF	
2	6072330	MCP 10A-M-H-30µF-CEE7/7 VP.	1
2.1	6071703	capacitor 400V 30µF MCP VP.	1
2.2	6071705	protection switch 10A MCP VP.	1
2.3	6071707	protecting cap MCP VP.	1
		IN (230V / 50Hz) <6A - 20µF	
3	6072331	MCP 6A-M-HA-20µF-CEE7/7 VP.	1
3.1	6071702	capacitor 400V 20µF MCP VP.	1
3.2	6071704	protection switch 6A MCP VP.	1
3.3	6071707	protecting cap MCP VP.	2
3.4	6071706	switch on/out MCP VP.	1
		IN (230V / 50Hz) 6-10A - 30µF	
4	6072329	MCP 10A-M-HA-30µF-CEE7/7 VP	1
4.1	6071703	capacitor 400V 30µF MCP VP.	1
4.2	6071705	protection switch 10A MCP VP.	1
4.3	6071707	protecting cap MCP VP.	2
4.4	6071706	switch on/out MCP VP.	1
5	6003000	plug CEE16A/400V 60Hz/5P-11h	1
5	6003248	plug CEE16A/400V/4P-6H	1
5	6003009	plug CEE16A/400V/5P-6H	1
5	6039156	plug CEE16A/400V/5P-6H Phase inverter	1
5	6035231	plug CEE16A/400V/7P-6H	1
5	6003011	plug CEE16A/500V/5P-7H	1
6	6030883	plug MS400V5P CEE16A W 1,0-1,6A	1
6	6030884	plug MS400V5P CEE16A W 1,6-2,5A	1
6	6030888	plug MS400V5P CEE16A W 10,0-16,0A	1
6	6030885	plug MS400V5P CEE16A W 2,5-4,0A	1
6	6030886	plug MS400V5P CEE16A W 4,0-6,3A	1
6	6030887	plug MS400V5P CEE16A W 6,3-10,0A	1

PLUG

Item	Article no.	Description	Quantity
7	6032446	plug MS400V4P CEE16A WD 1,6-2,5A	1
7	6032447	plug MS400V4P CEE16A WD 12,5-16,0A	1
7	6032295	plug MS400V4P CEE16A WD 2,5-4,0A	1
7	6032289	plug MS400V4P CEE16A WD 4,0-6,3A	1
7	6032292	plug MS400V4P CEE16A WD 6,3-9,0A	1
7	6042190	plug MS400V5P CEE16A WDII 1,6-2,5A	1
7	6042194	plug MS400V5P CEE16A WDII 10,0-16,0A	1
7	6042191	plug MS400V5P CEE16A WDII 2,5-4,0A	1
7	6042192	plug MS400V5P CEE16A WDII 4,0-6,3A	1
7	6042193	plug MS400V5P CEE16A WDII 6,3-10,0A	1
7	6035911	plug MS400V5P CEE16A WD 9,0-12,5A	1
7	6003337	plug MS500V5P CEE16A WD 1,6-2,5A	1
7	6003336	plug MS500V5P CEE16A WD 2,5-4,0A	1
7	6003335	plug MS500V5P CEE16A WD 4,0-6,3A	1
7	6003334	plug MS500V5P CEE16A WD 6,3-9,0A	1
8	6072520	MCP 1,0-1,6A-T4-HA-ROT-WSK-CEE16-5PS VP.	1
8	6072521	MCP 1,6-2,4A-T4-HA-ROT-WSK-CEE16-5PS VP.	1
8	6072522	MCP 2,4-4,0A-T4-HA-ROT-WSK-CEE16-5PS VP.	1
8	6072523	MCP 4,0-6,0A-T4-HA-ROT-WSK-CEE16-5PS VP.	1
8	6072524	MCP 6,0-10A-T4-HA-ROT-WSK-CEE16-5PS VP.	1
8	6072525	MCP 9,0-12A-T4-HA-ROT-WSK-CEE16-5PS VP.	1
8	6072526	MCP 12-16A-T4-HA-ROT-WSK-CEE16-5PS VP.	1
9	6003267	plug CEE32A/400V/4P-6H	1
9	6039155	plug CEE32A/400V/5P-6H Phase inverter	1
9	6035895	plug CEE32A/500V/4P-7H AM-Top	1
9	6003010	plug CEE32A/500V/5P-7H	1
10	6072370	MCP 400V 1,6-2,5A-T4-H-ROT-CEE32-5PS VP.	1
10	6072369	MCP 400V 2,5-4,0A-T4-H-ROT-CEE32-5PS VP.	1
10	6072371	MCP 400V 4,0-6,3A-T4-H-ROT-CEE32-5PS VP.	1
10	6072398	MCP 400V 6,3-10A-T4-H-ROT-CEE32-5PS VP.	1
10	6072519	MCP 400V 10-16A-T4-H-ROT-CEE32-5PS VP.	1
10	6072399	MCP 400V 16-20A-T4-H-ROT-CEE32-5PS VP.	1
10	6072518	MCP 400V 20-25A-T4-H-ROT-CEE32-5PS VP.	1
10	6037649	plug.MS500V4P CEE32A WD 2,5-4,0A	1

PLUG

Item	Article no.	Description	Quantity
10	6041268	plug MS500V4P CEE32A WD 4,0-6,3A	1
10	6035244	plug MS500V5P CEE32A WD 1,6-2,5A	1
10	6034700	plug MS500V5P CEE32A WD 2,5-4,0A	1
10	6041556	plug MS500V5P CEE32A WD 4,0-6,3A	1
10	6002701	plug MS500V5P CEE32A WD 9,0-12,5A	1
10	6002700	plug MS500V5P CEE32A WD 12,5-16,0A	1
11	6003241	plug MS400V5P CEE32A WDSHA 10,0-14,0A	1
11	6003266	plug MS400V5P CEE32A WDSHA 3,7-5,5A	1
11	6003265	plug MS400V5P CEE32A WDSHA 5,5-8,0A	1
11	6003264	plug MS400V5P CEE32A WDSHA 8,0-11,5A	1
12	6003012	plug CEE63A/400V/5P-6H/IP67	1

cable for motor F12 / F13

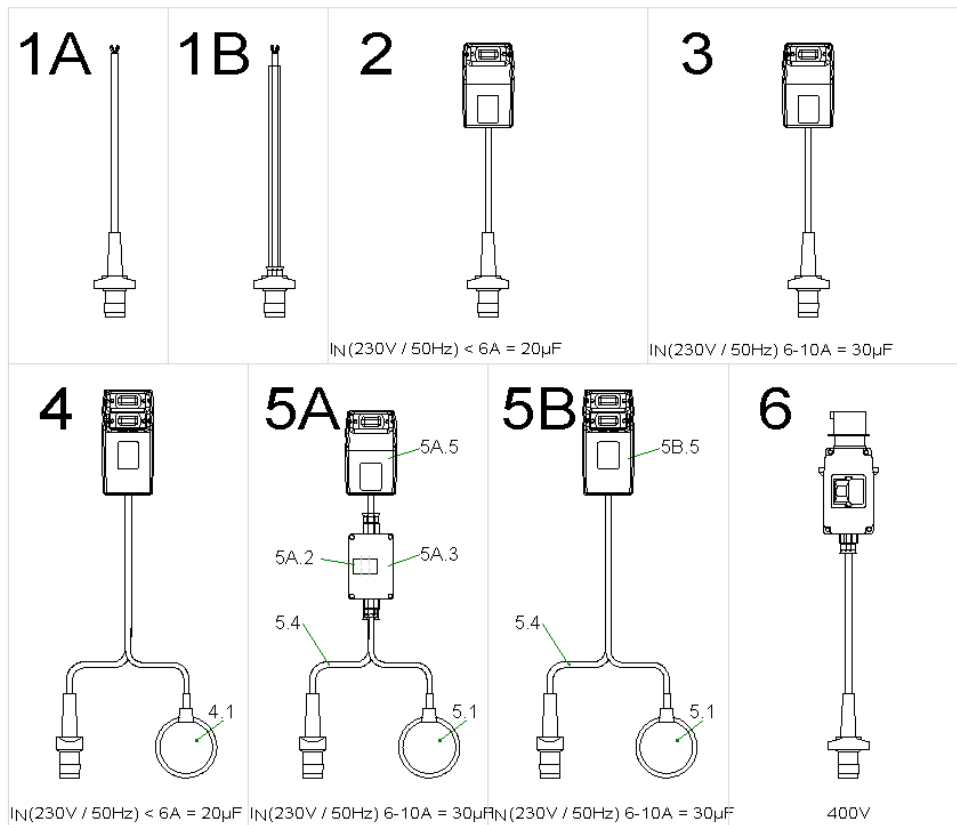

cable for motor F12 / F13

Item	Article no.	Description	Quantity
1A	6072559	cable 5m H07 4G1,5/coupling VP.	1
1A	6072560	cable 10m H07 4G1,5/coupling VP.	1
1A	6072561	cable 20m H07 4G1,5/coupling VP.	1
1A	6072562	cable 30m H07 4G1,5/coupling VP.	1
1A	6072563	cable 40m H07 4G1,5/coupling VP.	1
1A	6087533	cable 40m H07 4G1,5/coupling VP.	1
1B	6072564	cable 10m H07 4G1,5/coupl./hose VP. IN (230V / 50Hz) <6A - 20µF	1
2	6072565	switch box MCP 6A H 5M VP.	1
2	6072566	switch box MCP 6A H 10M VP.	1
2	6072567	switch box MCP 6A H 20M VP. IN (230V / 50Hz) 6-10A - 30µF	1
3	6072568	switch box MCP 10A H 5M VP.	1
3	6072569	switch box MCP 10A H 10M VP.	1
3	6072570	switch box MCP 10A H 20M VP. IN (230V / 50Hz) <6A - 20µF	1
4	6072571	switch box MCP 6A HA 5M VP.	1
4	6072572	switch box MCP 6A HA 10M VP.	1
4.1	6072582	float switch S-PS 10A 250V 10m NO VP	1
4	6072576	switch box MCP 6A HA 20M VP.	1
4.1	6072583	float switch S-PS 10A 250V 20m NO VP IN (230V / 50Hz) 6-10A - 30µF	1
5A		on request	1
5B	6072577	switch box MCP 10A HA 10M	1
5.1	6072582	float switch S-PS 10A 250V 10m NO VP	1
5A.2	6003341	contactor 5,5 kW 230 V, 50 Hz	1
5A.3	6031509	blank casing KS12/15ES KIT	1
5.4	6072560	cable 10m H07 4G1,5/coupling VP.	1
5A.5	6072330	MCP 10A-M-H-30µF-CEE7/7 VP.	1
5B.5	6072329	MCP 10A-M-HA-30µF-CEE7/7 VP für / for / pour 400V	1
6	6023991	switch box CEEM16W 2,5A, 10m SVA	1
6	6001253	switch box CEEM16W 4A, 10m SVA	1
6	6023992	switch box CEEM16W 6,3A, 20m SVA	1

CONTRACTOR'S PUMP KS15GG UNIT (600089)

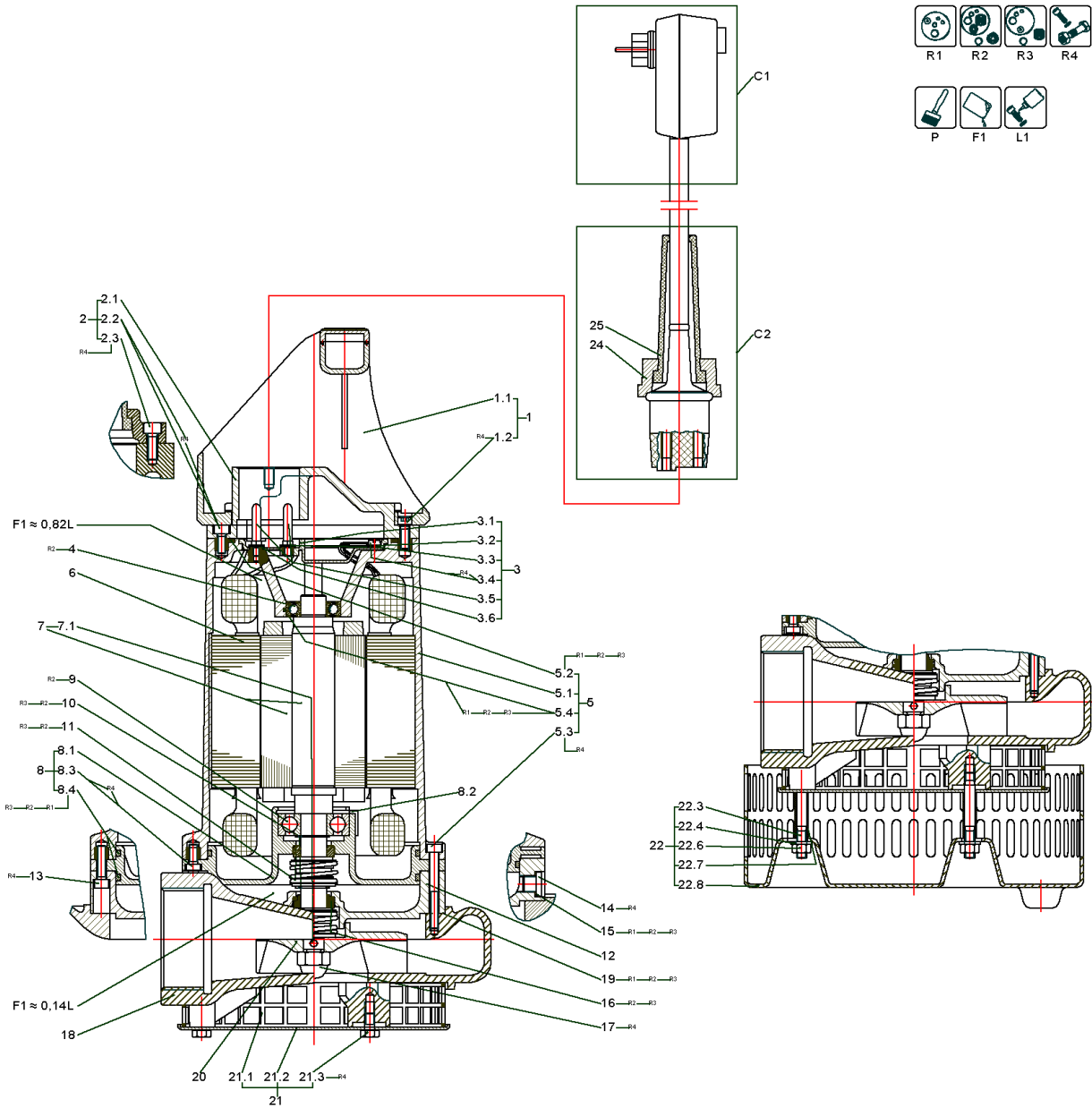

CONTRACTOR'S PUMP KS15GG UNIT (6000089)

Item	Article no.	Description	Quantity
R1	6016267	Rep.Kit 1 KS8,9,12,14,15, F12 Vit	1
R2	6016308	Rep.Kit 2 KS8,9,12,14,15	1
R3	6016307	Rep.Kit 3 KS8,9,12,14,15	1
R4	6016132	Screws KS8,9,12,14,15 KE7;8;9, F12 KIT	1
P	6042254	PAINT SPRAY Pantone334	1
P	6042255	colour 2K-paint IV80 pantone334C 250ml	1
P	6023614	Ceram C0 black 100 ml KIT	1
P	6020579	Ceram C0 black 250 ml KIT	1
P	6023485	Ceram C0 Black 500ml Kit	1
P	6019157	Ceram C0 black 1000 ml KIT	1
F1	6025460	medical white oil 1L KIT	1
F1	6025461	medical white oil 5L KIT	1
L1	6080531	Loctite 243 5g flask VP:	1
L1	2096167	Loctite 243 50ml VP.	1

C1		PLUG	1
C2		cable for motor F12 / F13	1

1	6019566	handle 51.15480/1 plastics KIT	1
1.2		> screw M5x16 ISO4762 A2-70	1
1.1		> handle 51.15480/1 Akulon	1
2	6022949	motor cover D.95,8 51.17219 GG KIT	1
2.1		> motor cover D.95,8 51.17219 GG	1
2.2		> SCREW M5X12 ISO4762 A2-70	3
2.3		> screw M6x16 DIN912 A4 (10pc)	1
3	6001273	terminal board 54.3453 Makrolon KIT	1
3.1		> terminal board plastics Polycarbonat	1
3.5		> contact pin Ms	4
3.2		> lock washer 4 DIN7980 A4	1
3.3		> washer A4,3 DIN125 Ms	5
3.4		> screw M4x8 DIN84 Ms	1
3.6		> washer 4,3 DIN7349 Ms	1
4	6086141	ball bearing 6002 VP.	1
5.1	6013826	motor casing 52.12657 GG	1

CONTRACTOR'S PUMP KS15GG UNIT (6000089)

Item	Article no.	Description	Quantity
5.2		o-ring ID.92,0x3,0 Viton	1
5.3		screw M5x45 ISO4762 A2-70	3
5.4		o-ring ID.32x1,78 Viton	1
		Stator / stator / stator 50 Hz	
6	6023541	stator F12-2/9 230E 50Hz Ser11	1
6	6023538	stator F12-2/9 230/400 50Hz	1
6	6023539	stator F12-2/9 415 50Hz VN 01	1
6	6023540	stator F12-2/9 500 50Hz VN 01	1
6	6061716	stator F12-2/9 690 50Hz	1
		Stator / stator / stator 60 Hz	
6	6023542	stator F12-2/9 220/380 60Hz	1
7	6010002	rotor D.61,4x225 2/9 1.4021	1
8	6042497	bearing housing U 6050660 GG KIT	1
8.1		> lower bearing D.42H7 6050660 GG	1
8.2	6004669	> circlips 43,6x1,8 54.3438 FSt	1
8.3		> screw M5x12 DIN6912 A2-70	3
8.4		> o-ring ID.115,0x3,0 Viton -	2
9	6008975	ball bearing 6302	1
10	6002007	circlips 15x1 DIN471 FSt	2
11	6075396	mech shaft seal MG1/15-G64 BXPGG VP.	1
12	6013732	sealing casing D.125f6 53.3452 GG	1
		alternativ / alternative / alternative	
12	6013724	sealing casing D.125f6 53.3452 GG/C0	1
12	6013730	sealing casing D.125f6 53.3452 GG/C1	1
13		screw M5x20 ISO4762 A2	3
14	6002430	screw plug G1/8 DIN908 A2	1
15	6048829	joint ring A10/13,5x1,5 DIN7603 PA(10pc)	1
16	6075381	mechanical shaft seal MG1/15-G4 Q1Q1PGG	1
		alternativ / alternative / alternative	
16	6003878	mechanical shaft seal MG1/15-G4 Q1Q1VGG	1
17	6002104	domet nut M10 DIN1587 A2	1
18	6012843	pump housing QG2 52.1116/1 GG	1
		alternativ / alternative / alternative	
18	6012841	pump housing QG2 52.1116/1 GG/C0	1

CONTRACTOR'S PUMP KS15GG UNIT (6000089)

Item	Article no.	Description	Quantity
18	6012842	pump housing QG2 52.1116/1 GG/C1C1	1
18	6012687	pump housing QG2 52.17943 Abrasit	1
18	6024251	pump housing QG2 52.17943 Abrasit/CO	1
18	6012902	pump housing QG2 51.16783 1.4581	1
19	6048831	flat gasket D.125/155 ARAMID/NBR (10pc)	1
		Laufrad / Impeller / Roue 50Hz	
20	6014039	impeller-W D.119 53.1047 GG	1
		alternativ / alternative / alternative	
20	6014046	impeller-W D.119 54.1047 GG/CO	1
20	6021687	impeller-W D.119 54.1047 GG/C1	1
20	6014149	impeller-W D.119 53.18032 Abrasit	1
20	6024247	impeller-W D.119 53.18032 Abrasit/CO	1
	6014038	impeller-W D.119 53.1047 1.4581	1
	6014047	impeller-W D.119 54.1047 1.4581/CO	1
		Laufrad / Impeller / Roue 60Hz	
20	6022660	impeller-W D.109 53.1047 GG	1
		alternativ / alternative / alternative	
20	6022663	impeller-W D.109 54.1047 GG/CO	1
20	6022662	impeller-W D.109 54.1047 GG/C1	1
20	6022664	impeller-W D.109 53.18032 Abrasit	1
20	6024248	impeller-W D.109 54.18032 Abrasit/CO	1
21	6001295	strainer 54.10534/1 1.4301 KIT	1
21.1		> strainer 26x155x2 1.4301	1
21.2		> base plate D.160x3 1,5 1.4301	1
21.3		> screw M6x10 ISO4017 A2-70	3
22	6032618	add on strainer KS 14/15 KIT	1
24	6004828	cable gland Akulon	1
25	6003824	cable peotection NBR 87x30 mm	1

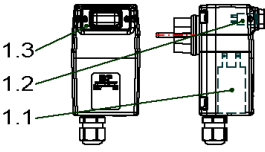
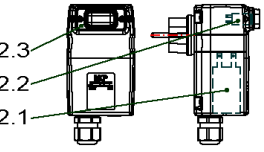
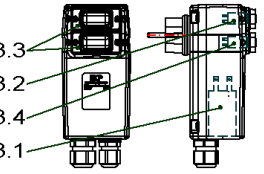
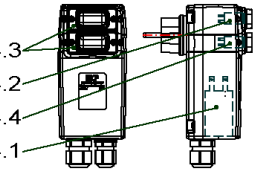
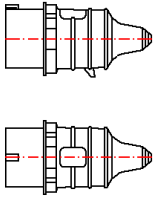
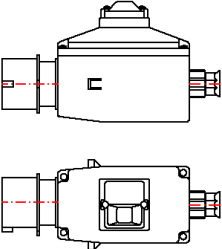
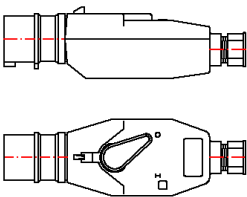
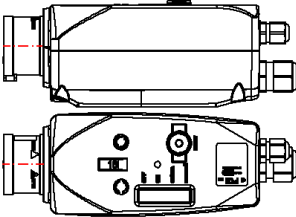
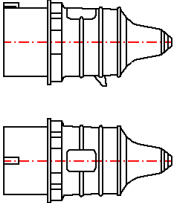
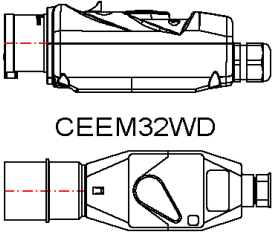
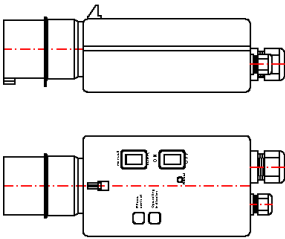
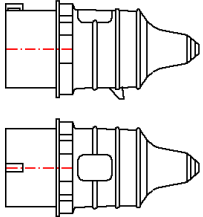
<p>1 MCP 6A-M-H-20μF ~ 230V</p>  <p>$I_N(230V / 50Hz) < 6A = 20\mu F$</p>	<p>2 MCP 10A-M-H-30μF ~ 230V</p>  <p>$I_N(230V / 50Hz) 6-10A = 30\mu F$</p>	<p>3 MCP 6A-M-HA-20μF ~ 230V</p>  <p>$I_N(230V / 50Hz) < 6A = 20\mu F$</p>	<p>4 MCP 10A-M-HA-30μF ~ 230V</p>  <p>$I_N(230V / 50Hz) 6-10A = 30\mu F$</p>
<p>5 CEE16A</p> 	<p>6 CEEM16W</p> 	<p>7 CEEM16WD</p> 	<p>8 MCP T4-HA-ROT-WSK CEE16-5PS</p> 
<p>9 CEE32A</p> 	<p>10 MCP 10-16A-T4-H-ROT CEE32-5PS</p>  <p>CEEM32WD</p>	<p>11 CEEM32WDSHA</p> 	<p>12 CEE63A</p> 

PLUG

Item	Article no.	Description	Quantity
		IN (230V / 50Hz) <6A - 20μF	
1	6072332	MCP 6A-M-H-20μF-CEE7/7 VP.	1
1.1	6071702	capacitor 400V 20μF MCP VP.	1
1.2	6071704	protection switch 6A MCP VP.	1
1.3	6071707	protecting cap MCP VP.	1
		IN (230V / 50Hz) 6-10A - 30μF	
2	6072330	MCP 10A-M-H-30μF-CEE7/7 VP.	1
2.1	6071703	capacitor 400V 30μF MCP VP.	1
2.2	6071705	protection switch 10A MCP VP.	1
2.3	6071707	protecting cap MCP VP.	1
		IN (230V / 50Hz) <6A - 20μF	
3	6072331	MCP 6A-M-HA-20μF-CEE7/7 VP.	1
3.1	6071702	capacitor 400V 20μF MCP VP.	1
3.2	6071704	protection switch 6A MCP VP.	1
3.3	6071707	protecting cap MCP VP.	2
3.4	6071706	switch on/out MCP VP.	1
		IN (230V / 50Hz) 6-10A - 30μF	
4	6072329	MCP 10A-M-HA-30μF-CEE7/7 VP	1
4.1	6071703	capacitor 400V 30μF MCP VP.	1
4.2	6071705	protection switch 10A MCP VP.	1
4.3	6071707	protecting cap MCP VP.	2
4.4	6071706	switch on/out MCP VP.	1
5	6003000	plug CEE16A/400V 60Hz/5P-11h	1
5	6003248	plug CEE16A/400V/4P-6H	1
5	6003009	plug CEE16A/400V/5P-6H	1
5	6039156	plug CEE16A/400V/5P-6H Phase inverter	1
5	6035231	plug CEE16A/400V/7P-6H	1
5	6003011	plug CEE16A/500V/5P-7H	1
6	6030883	plug MS400V5P CEE16A W 1,0-1,6A	1
6	6030884	plug MS400V5P CEE16A W 1,6-2,5A	1
6	6030888	plug MS400V5P CEE16A W 10,0-16,0A	1
6	6030885	plug MS400V5P CEE16A W 2,5-4,0A	1
6	6030886	plug MS400V5P CEE16A W 4,0-6,3A	1
6	6030887	plug MS400V5P CEE16A W 6,3-10,0A	1

PLUG

Item	Article no.	Description	Quantity
7	6032446	plug MS400V4P CEE16A WD 1,6-2,5A	1
7	6032447	plug MS400V4P CEE16A WD 12,5-16,0A	1
7	6032295	plug MS400V4P CEE16A WD 2,5-4,0A	1
7	6032289	plug MS400V4P CEE16A WD 4,0-6,3A	1
7	6032292	plug MS400V4P CEE16A WD 6,3-9,0A	1
7	6042190	plug MS400V5P CEE16A WDII 1,6-2,5A	1
7	6042194	plug MS400V5P CEE16A WDII 10,0-16,0A	1
7	6042191	plug MS400V5P CEE16A WDII 2,5-4,0A	1
7	6042192	plug MS400V5P CEE16A WDII 4,0-6,3A	1
7	6042193	plug MS400V5P CEE16A WDII 6,3-10,0A	1
7	6035911	plug MS400V5P CEE16A WD 9,0-12,5A	1
7	6003337	plug MS500V5P CEE16A WD 1,6-2,5A	1
7	6003336	plug MS500V5P CEE16A WD 2,5-4,0A	1
7	6003335	plug MS500V5P CEE16A WD 4,0-6,3A	1
7	6003334	plug MS500V5P CEE16A WD 6,3-9,0A	1
8	6072520	MCP 1,0-1,6A-T4-HA-ROT-WSK-CEE16-5PS VP.	1
8	6072521	MCP 1,6-2,4A-T4-HA-ROT-WSK-CEE16-5PS VP.	1
8	6072522	MCP 2,4-4,0A-T4-HA-ROT-WSK-CEE16-5PS VP.	1
8	6072523	MCP 4,0-6,0A-T4-HA-ROT-WSK-CEE16-5PS VP.	1
8	6072524	MCP 6,0-10A-T4-HA-ROT-WSK-CEE16-5PS VP.	1
8	6072525	MCP 9,0-12A-T4-HA-ROT-WSK-CEE16-5PS VP.	1
8	6072526	MCP 12-16A-T4-HA-ROT-WSK-CEE16-5PS VP.	1
9	6003267	plug CEE32A/400V/4P-6H	1
9	6039155	plug CEE32A/400V/5P-6H Phase inverter	1
9	6035895	plug CEE32A/500V/4P-7H AM-Top	1
9	6003010	plug CEE32A/500V/5P-7H	1
10	6072370	MCP 400V 1,6-2,5A-T4-H-ROT-CEE32-5PS VP.	1
10	6072369	MCP 400V 2,5-4,0A-T4-H-ROT-CEE32-5PS VP.	1
10	6072371	MCP 400V 4,0-6,3A-T4-H-ROT-CEE32-5PS VP.	1
10	6072398	MCP 400V 6,3-10A-T4-H-ROT-CEE32-5PS VP.	1
10	6072519	MCP 400V 10-16A-T4-H-ROT-CEE32-5PS VP.	1
10	6072399	MCP 400V 16-20A-T4-H-ROT-CEE32-5PS VP.	1
10	6072518	MCP 400V 20-25A-T4-H-ROT-CEE32-5PS VP.	1
10	6037649	plug.MS500V4P CEE32A WD 2,5-4,0A	1

PLUG

Item	Article no.	Description	Quantity
10	6041268	plug MS500V4P CEE32A WD 4,0-6,3A	1
10	6035244	plug MS500V5P CEE32A WD 1,6-2,5A	1
10	6034700	plug MS500V5P CEE32A WD 2,5-4,0A	1
10	6041556	plug MS500V5P CEE32A WD 4,0-6,3A	1
10	6002701	plug MS500V5P CEE32A WD 9,0-12,5A	1
10	6002700	plug MS500V5P CEE32A WD 12,5-16,0A	1
11	6003241	plug MS400V5P CEE32A WDSHA 10,0-14,0A	1
11	6003266	plug MS400V5P CEE32A WDSHA 3,7-5,5A	1
11	6003265	plug MS400V5P CEE32A WDSHA 5,5-8,0A	1
11	6003264	plug MS400V5P CEE32A WDSHA 8,0-11,5A	1
12	6003012	plug CEE63A/400V/5P-6H/IP67	1

cable for motor F12 / F13

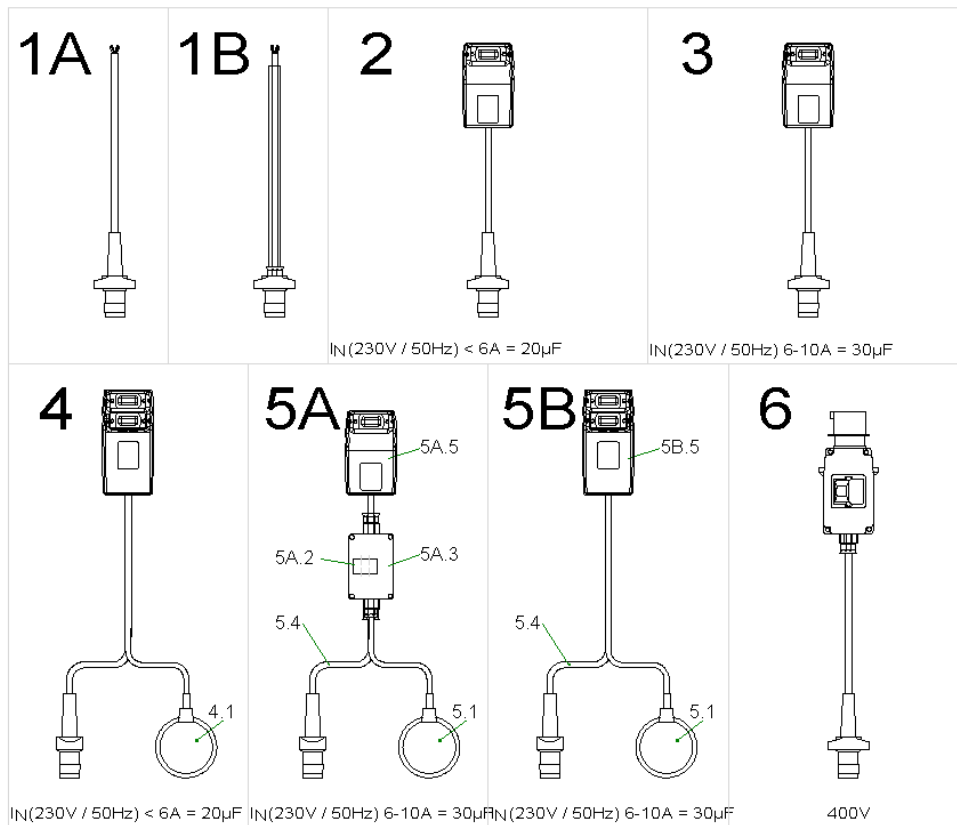

cable for motor F12 / F13

Item	Article no.	Description	Quantity
1A	6072559	cable 5m H07 4G1,5/coupling VP.	1
1A	6072560	cable 10m H07 4G1,5/coupling VP.	1
1A	6072561	cable 20m H07 4G1,5/coupling VP.	1
1A	6072562	cable 30m H07 4G1,5/coupling VP.	1
1A	6072563	cable 40m H07 4G1,5/coupling VP.	1
1A	6087533	cable 40m H07 4G1,5/coupling VP.	1
1B	6072564	cable 10m H07 4G1,5/coupl./hose VP. IN (230V / 50Hz) <6A - 20μF	1
2	6072565	switch box MCP 6A H 5M VP.	1
2	6072566	switch box MCP 6A H 10M VP.	1
2	6072567	switch box MCP 6A H 20M VP. IN (230V / 50Hz) 6-10A - 30μF	1
3	6072568	switch box MCP 10A H 5M VP.	1
3	6072569	switch box MCP 10A H 10M VP.	1
3	6072570	switch box MCP 10A H 20M VP. IN (230V / 50Hz) <6A - 20μF	1
4	6072571	switch box MCP 6A HA 5M VP.	1
4	6072572	switch box MCP 6A HA 10M VP.	1
4.1	6072582	float switch S-PS 10A 250V 10m NO VP	1
4	6072576	switch box MCP 6A HA 20M VP.	1
4.1	6072583	float switch S-PS 10A 250V 20m NO VP IN (230V / 50Hz) 6-10A - 30μF	1
5A		on request	1
5B	6072577	switch box MCP 10A HA 10M	1
5.1	6072582	float switch S-PS 10A 250V 10m NO VP	1
5A.2	6003341	contactor 5,5 kW 230 V, 50 Hz	1
5A.3	6031509	blank casing KS12/15ES KIT	1
5.4	6072560	cable 10m H07 4G1,5/coupling VP.	1
5A.5	6072330	MCP 10A-M-H-30μF-CEE7/7 VP.	1
5B.5	6072329	MCP 10A-M-HA-30μF-CEE7/7 VP für / for / pour 400V	1
6	6023991	switch box CEEM16W 2,5A, 10m SVA	1
6	6001253	switch box CEEM16W 4A, 10m SVA	1
6	6023992	switch box CEEM16W 6,3A, 20m SVA	1

KS16

Bm3

S/N < 650051950

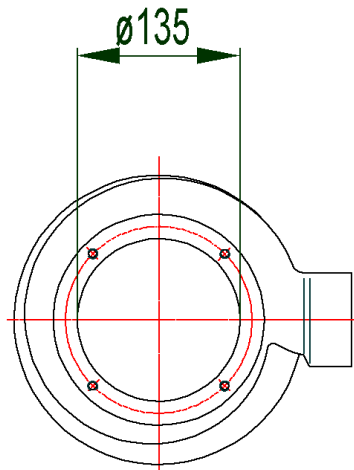
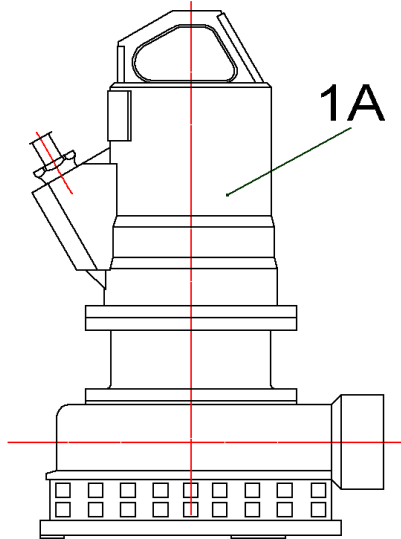

Bm4

S/N > 650051951

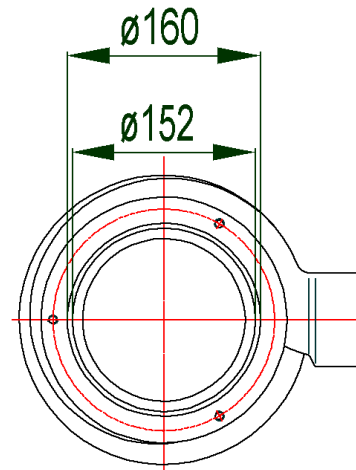
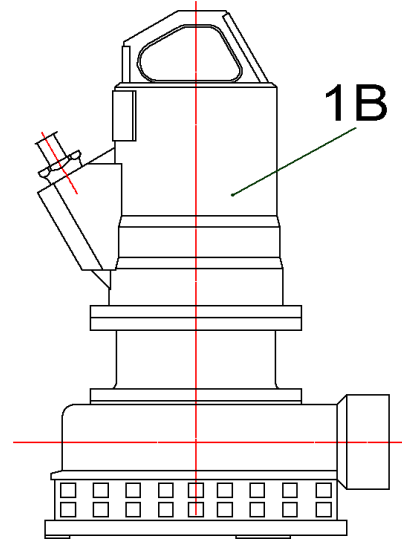

CONTRACTOR'S PUMP KS16 UNIT (6000090)

Item	Description	Quantity
1A	CONTRACTOR'S PUMP KS16 (Bm3) UNIT	1
1B	CONTRACTOR'S PUMP KS16 (Bm4) UNIT	1

CONTRACTOR'S PUMP KS16 (Bm3) UNIT

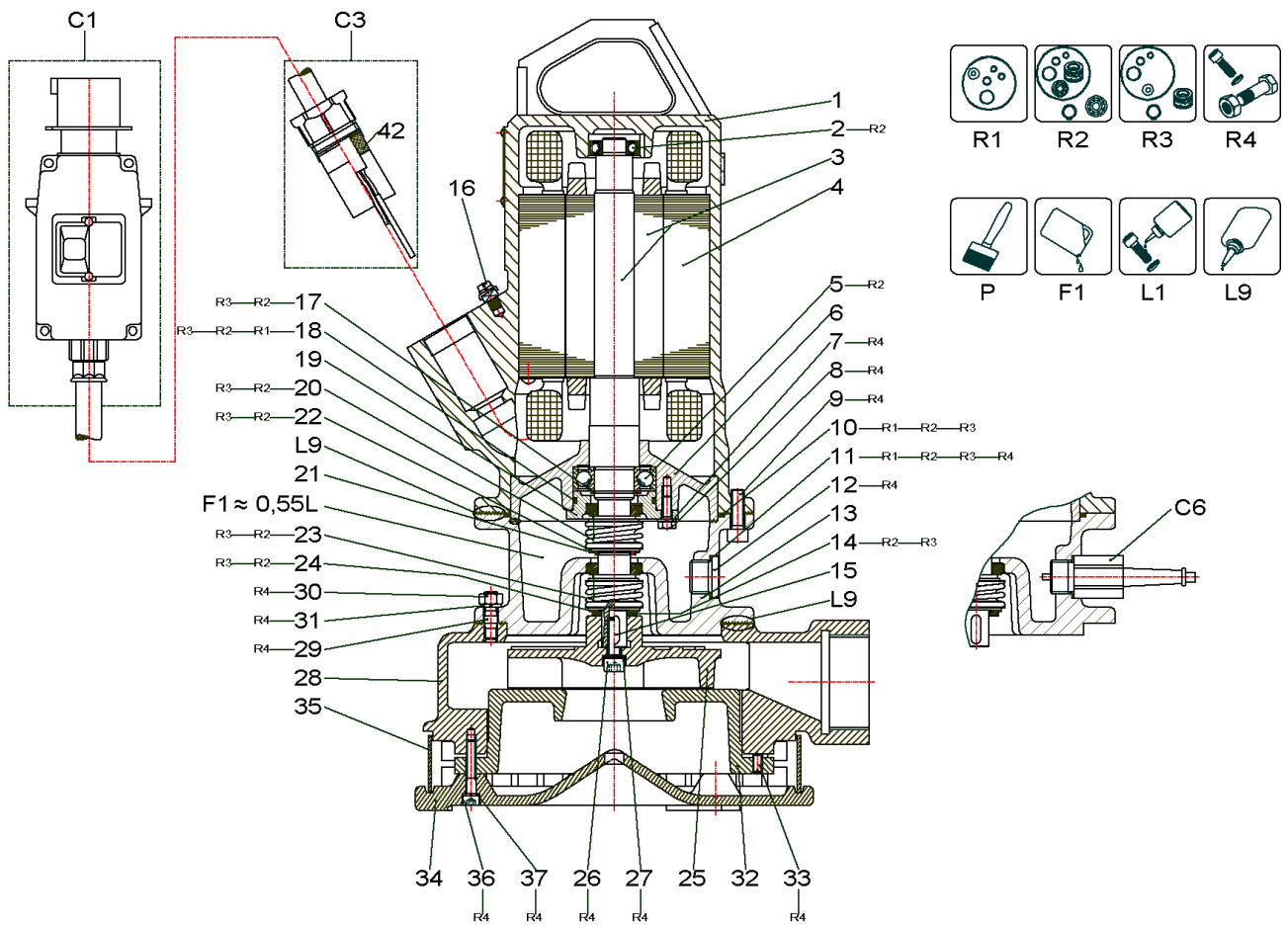

CONTRACTOR'S PUMP KS16 (Bm3) UNIT

Item	Article no.	Description	Quantity
R1	6016204	Rep.Kit 1 T12K, T12G BM2 / BM3 Vit	1
R2	6016074	Rep.Kit 2 T12K;T12G Bm2/Bm3 Vit	1
R3	6016073	Rep.Kit 3 T12K;T12G Bm2/Bm3 Vit	1
R4	6042219	Screws KS5,6,16/T12 KIT	1
P	6042254	PAINT SPRAY Pantone334	1
P	6023614	Ceram C0 black 100 ml KIT	1
P	6020579	Ceram C0 black 250 ml KIT	1
P	6023485	Ceram C0 Black 500ml Kit	1
P	6019157	Ceram C0 black 1000 ml KIT	1
F1	6025460	medical white oil 1L KIT	1
L1	6080531	Loctite 243 5g flask VP:	1
L1	2096167	Loctite 243 50ml VP.	1
L9	6080535	Loctite 5203 300ml VP.	1

C1		PLUG	1
C3		cable trumpet 30T KIT	1
C6		electrode KIT	1

1	6085138	motor casing 50.17232/2 GG VP.	1
2	6086141	ball bearing 6002 VP.	1
3	6010587	rotor D.61,4x320 2/11 1.4021 K	1
4	6023504	stator T12-2/11 400 50Hz VN01	1
5	2046946	ball bearing 6205/2RS-C3 (HT) VP.	1
6	6085141	bearing housing 53.17238 GG VP.	1
7		lock washer 6 DIN7980 A4	3
8		screw M6x16 DIN933 A2-70 (10pc)	1
9		screw M8x25 DIN912 A4 (10pc)	1
10		o-ring ID.125,0x3,0 Viton	1
11	6048832	joint ring A21/26x1,5 DIN7603 PA(10pc)	1
12	6067638	screw plug G1/2 DIN908 A4 (3pcs)	1
13	6013686	sealing casing D.135g6 52.17240 GG	1
		alternativ / alternative / alternative	
13	6013684	sealing casing D.135g6 52.17240 GG/C0	1
13	6013685	sealing casing D.135g6 52.17240 GG/C1	1

CONTRACTOR'S PUMP KS16 (Bm3) UNIT

Item	Article no.	Description	Quantity
14	6002118	washer 17 DIN433 A2	1
15	6004654	key A 6x4x18 54.2589 A4	1
16	6067407	Barlian bow terminal M5 A2	1
17	6002002	circlips 25x1,2 DIN471 FSt	1
18		-ring ID.44,0x3,0 Viton 75	1
19	6085142	bearing cover D.35H7 53.17239 GG VP.	1
20	6074596	mechanical shaft seal MG1/20-G64 Q1Q1VGG	1
21	6005374	pressure ring 31,6x1 1.4571	1
22	6002006	circlips 20x1,2 DIN471 1.4116	1
23	6074596	mechanical shaft seal MG1/20-G64 Q1Q1VGG	1
24	6005374	pressure ring 31,6x1 1.4571	1
25	6021653	impeller-W D.134 54.18835 GG	1
		alternativ / alternative / alternative	
25	6021748	impeller-W D.134 54.18835 GG	1
26	6003416	screw M8x25 DIN912 10.9 Geomet	1
27	6002688	screw locking Nord-Lock 13,5/8,7 A4	1
28	6021640	pump housing QG2 52.18831 GG	1
		alternativ / alternative / alternative	
28	6021684	pump housing QG2 52.18831 GG/C0	1
29		screw M8x20 DIN939 A2-70	4
30		nut M8 DIN934 A2-80	4
31		lock washer 8 DIN7980 A4 (20pc)	1
32	6012778	suction port 52.14302 GG	1
		alternativ / alternative / alternative	
32	6012777	suction port 52.14302 GG/C0	1
33		threaded pin M6x12 DIN551 A4	4
34	6017612	base plate D.250 52.14304 GG	1
		alternativ / alternative / alternative	
34	6017603	base plate D.250 52.14304 GG/C0	1
35	6004794	strainer 36x234x2 1.4301	1
36		screw M6x35 ISO4762 A4-70	4
37		lock washer 6 DIN7980 A4	4
42	6076649	seal ring D.29,5/16x16,5 54.17777NBR VP.	1
42	6076650	seal ring D.29,5/17x16,5 54.17777 NBR VP	1

CONTRACTOR'S PUMP KS16 (Bm3) UNIT

Item	Article no.	Description	Quantity
42	6076651	seal ring D.29,5/19x16,5 54.17777NBR VP.	1
		alternativ / alternative / alternative	
42	6037031	seal ring D.29,5/16x16,5 CR silicon free	1
42	6037478	seal ring D.29,5/19x16,5 CR silicon free	1

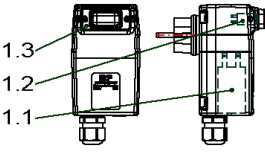
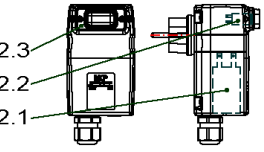
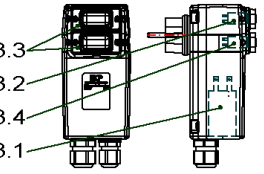
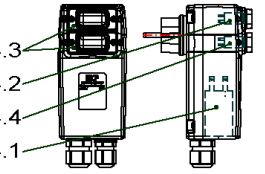
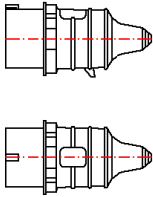
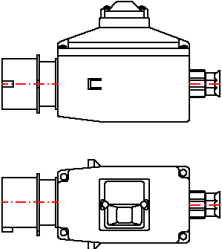
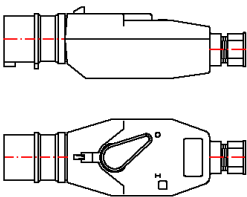
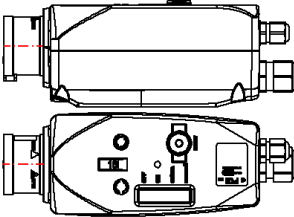
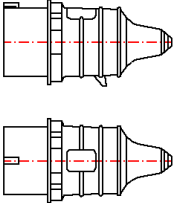
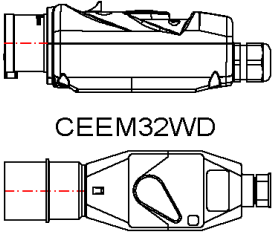
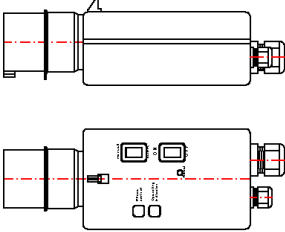
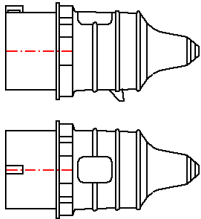
<p>1 MCP 6A-M-H-20μF ~ 230V</p>  <p>$I_N(230V / 50Hz) < 6A = 20\mu F$</p>	<p>2 MCP 10A-M-H-30μF ~ 230V</p>  <p>$I_N(230V / 50Hz) 6-10A = 30\mu F$</p>	<p>3 MCP 6A-M-HA-20μF ~ 230V</p>  <p>$I_N(230V / 50Hz) < 6A = 20\mu F$</p>	<p>4 MCP 10A-M-HA-30μF ~ 230V</p>  <p>$I_N(230V / 50Hz) 6-10A = 30\mu F$</p>
<p>5 CEE16A</p> 	<p>6 CEEM16W</p> 	<p>7 CEEM16WD</p> 	<p>8 MCP T4-HA-ROT-WSK CEE16-5PS</p> 
<p>9 CEE32A</p> 	<p>10 MCP 10-16A-T4-H-ROT CEE32-5PS</p>  <p>CEEM32WD</p>	<p>11 CEEM32WDSHA</p> 	<p>12 CEE63A</p> 

PLUG

Item	Article no.	Description	Quantity
		IN (230V / 50Hz) <6A - 20µF	
1	6072332	MCP 6A-M-H-20µF-CEE7/7 VP.	1
1.1	6071702	capacitor 400V 20µF MCP VP.	1
1.2	6071704	protection switch 6A MCP VP.	1
1.3	6071707	protecting cap MCP VP.	1
		IN (230V / 50Hz) 6-10A - 30µF	
2	6072330	MCP 10A-M-H-30µF-CEE7/7 VP.	1
2.1	6071703	capacitor 400V 30µF MCP VP.	1
2.2	6071705	protection switch 10A MCP VP.	1
2.3	6071707	protecting cap MCP VP.	1
		IN (230V / 50Hz) <6A - 20µF	
3	6072331	MCP 6A-M-HA-20µF-CEE7/7 VP.	1
3.1	6071702	capacitor 400V 20µF MCP VP.	1
3.2	6071704	protection switch 6A MCP VP.	1
3.3	6071707	protecting cap MCP VP.	2
3.4	6071706	switch on/out MCP VP.	1
		IN (230V / 50Hz) 6-10A - 30µF	
4	6072329	MCP 10A-M-HA-30µF-CEE7/7 VP	1
4.1	6071703	capacitor 400V 30µF MCP VP.	1
4.2	6071705	protection switch 10A MCP VP.	1
4.3	6071707	protecting cap MCP VP.	2
4.4	6071706	switch on/out MCP VP.	1
5	6003000	plug CEE16A/400V 60Hz/5P-11h	1
5	6003248	plug CEE16A/400V/4P-6H	1
5	6003009	plug CEE16A/400V/5P-6H	1
5	6039156	plug CEE16A/400V/5P-6H Phase inverter	1
5	6035231	plug CEE16A/400V/7P-6H	1
5	6003011	plug CEE16A/500V/5P-7H	1
6	6030883	plug MS400V5P CEE16A W 1,0-1,6A	1
6	6030884	plug MS400V5P CEE16A W 1,6-2,5A	1
6	6030888	plug MS400V5P CEE16A W 10,0-16,0A	1
6	6030885	plug MS400V5P CEE16A W 2,5-4,0A	1
6	6030886	plug MS400V5P CEE16A W 4,0-6,3A	1
6	6030887	plug MS400V5P CEE16A W 6,3-10,0A	1

PLUG

Item	Article no.	Description	Quantity
7	6032446	plug MS400V4P CEE16A WD 1,6-2,5A	1
7	6032447	plug MS400V4P CEE16A WD 12,5-16,0A	1
7	6032295	plug MS400V4P CEE16A WD 2,5-4,0A	1
7	6032289	plug MS400V4P CEE16A WD 4,0-6,3A	1
7	6032292	plug MS400V4P CEE16A WD 6,3-9,0A	1
7	6042190	plug MS400V5P CEE16A WDII 1,6-2,5A	1
7	6042194	plug MS400V5P CEE16A WDII 10,0-16,0A	1
7	6042191	plug MS400V5P CEE16A WDII 2,5-4,0A	1
7	6042192	plug MS400V5P CEE16A WDII 4,0-6,3A	1
7	6042193	plug MS400V5P CEE16A WDII 6,3-10,0A	1
7	6035911	plug MS400V5P CEE16A WD 9,0-12,5A	1
7	6003337	plug MS500V5P CEE16A WD 1,6-2,5A	1
7	6003336	plug MS500V5P CEE16A WD 2,5-4,0A	1
7	6003335	plug MS500V5P CEE16A WD 4,0-6,3A	1
7	6003334	plug MS500V5P CEE16A WD 6,3-9,0A	1
8	6072520	MCP 1,0-1,6A-T4-HA-ROT-WSK-CEE16-5PS VP.	1
8	6072521	MCP 1,6-2,4A-T4-HA-ROT-WSK-CEE16-5PS VP.	1
8	6072522	MCP 2,4-4,0A-T4-HA-ROT-WSK-CEE16-5PS VP.	1
8	6072523	MCP 4,0-6,0A-T4-HA-ROT-WSK-CEE16-5PS VP.	1
8	6072524	MCP 6,0-10A-T4-HA-ROT-WSK-CEE16-5PS VP.	1
8	6072525	MCP 9,0-12A-T4-HA-ROT-WSK-CEE16-5PS VP.	1
8	6072526	MCP 12-16A-T4-HA-ROT-WSK-CEE16-5PS VP.	1
9	6003267	plug CEE32A/400V/4P-6H	1
9	6039155	plug CEE32A/400V/5P-6H Phase inverter	1
9	6035895	plug CEE32A/500V/4P-7H AM-Top	1
9	6003010	plug CEE32A/500V/5P-7H	1
10	6072370	MCP 400V 1,6-2,5A-T4-H-ROT-CEE32-5PS VP.	1
10	6072369	MCP 400V 2,5-4,0A-T4-H-ROT-CEE32-5PS VP.	1
10	6072371	MCP 400V 4,0-6,3A-T4-H-ROT-CEE32-5PS VP.	1
10	6072398	MCP 400V 6,3-10A-T4-H-ROT-CEE32-5PS VP.	1
10	6072519	MCP 400V 10-16A-T4-H-ROT-CEE32-5PS VP.	1
10	6072399	MCP 400V 16-20A-T4-H-ROT-CEE32-5PS VP.	1
10	6072518	MCP 400V 20-25A-T4-H-ROT-CEE32-5PS VP.	1
10	6037649	plug.MS500V4P CEE32A WD 2,5-4,0A	1

PLUG

Item	Article no.	Description	Quantity
10	6041268	plug MS500V4P CEE32A WD 4,0-6,3A	1
10	6035244	plug MS500V5P CEE32A WD 1,6-2,5A	1
10	6034700	plug MS500V5P CEE32A WD 2,5-4,0A	1
10	6041556	plug MS500V5P CEE32A WD 4,0-6,3A	1
10	6002701	plug MS500V5P CEE32A WD 9,0-12,5A	1
10	6002700	plug MS500V5P CEE32A WD 12,5-16,0A	1
11	6003241	plug MS400V5P CEE32A WDSHA 10,0-14,0A	1
11	6003266	plug MS400V5P CEE32A WDSHA 3,7-5,5A	1
11	6003265	plug MS400V5P CEE32A WDSHA 5,5-8,0A	1
11	6003264	plug MS400V5P CEE32A WDSHA 8,0-11,5A	1
12	6003012	plug CEE63A/400V/5P-6H/IP67	1

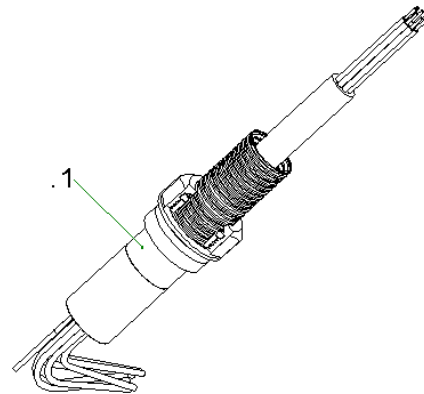
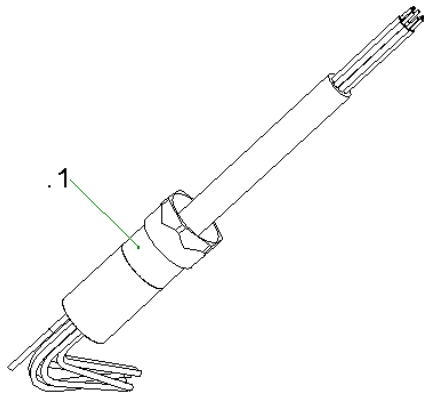

- 1 H07RN-F
- 2 NSSHOEU-J
- 3 SOOW

- 4 H07RN-F
- 5 NSSHOEU-J

cable trumpet 30T KIT

Item	Article no.	Description	Quantity
.1	6076649	seal ring D.29,5/16x16,5 54.17777NBR VP.	1
.1	6076651	seal ring D.29,5/19x16,5 54.17777NBR VP.	1
.1	6076650	seal ring D.29,5/17x16,5 54.17777 NBR VP	1
		alternativ / alternative / alternative	
.1	6037031	seal ring D.29,5/16x16,5 CR silicon free	1
.1	6037478	seal ring D.29,5/19x16,5 CR silicon free	1
1	6022379	cable trumpet 30T 5m H07 7G1,5 KIT	1
1	6019236	cable trumpet 30T 10m H07 7G1,5 KIT	1
1	6035928	cable trumpet 30T 15m H07 7G1,5 KIT	1
1	6060476	cable trumpet 30T 20m H07 7G1,5 KIT	1
1	6019164	cable trumpet 30T 25m H07 7G1,5 KIT	1
1	6060477	cable trumpet 30T 30m H07 7G1,5 KIT	1
1	6048268	cable trumpet 30T 35m H07 7G1,5 KIT	1
1	6060475	cable trumpet 30T 50m H07 7G1,5 KIT	1
1	6087356	cable trumpet 30T 10m H07 10G1,5 KIT	1
1	6041748	cable trumpet30T 15m H07 10G1,5 KIT	1
1	6080969	cable trumpet30T 20m H07 10G1,5 KIT	1
2	6031795	cable trumpet 30T 15m NSS 4x1,5 KIT	1
2	6040015	cable trumpet 30T 20m NSS 4x1,5 KIT	1
2	6035322	cable trumpet 30T 10m NSS 7x1,5 KIT	1
2	6028732	cable trumpet 30T 20m NSS 7x1,5 KIT	1
2	6026657	cable trumpet 30T 25m NSS 7x,1,5 KIT	1
2	6030434	cable trumpet 30T 15m NSS 7x2,5 KIT	1
3	6068166	cable trumpet 30T 10m 7* AWG 14 KIT	1
4	6042225	cable trumpet 30T 10m H07 7G1,5 C KIT	1
5	6042226	cable trumpet 30T 10m NSS 7x1,5 C KIT	1
5	6063462	cable trumpet 30T 15m NSS 7x1,5 C KIT	1
5	6063021	cable trumpet 30T 20m NSS 7x,1,5 C KIT	1

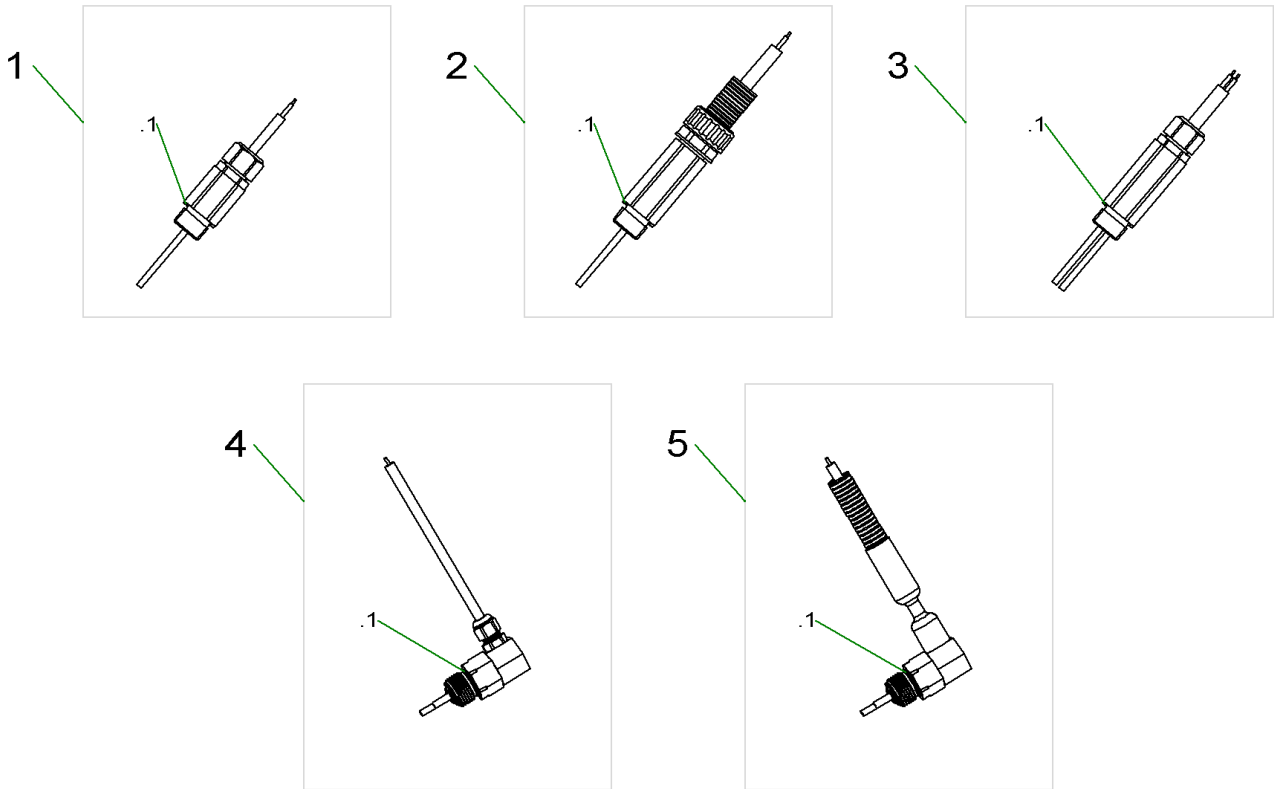

electrode KIT

Item	Article no.	Description	Quantity
.1	6048832	joint ring A21/26x1,5 DIN7603 PA(10pc)	1
1	6042222	pencil electrode G1/2 10m KIT	1
1	6042313	pencil electrode G1/2 15m KIT	1
1	6042223	pencil electrode G1/2 20m KIT	1
1	6061068	pencil electrode G1/2 25KIT	1
1	6061070	pencil electrode G1/2 30m KIT	1
1	6061069	Stabelektrode G1/2 40m SET	1
1	6060956	pencil electrode G1/2 55m KIT	1
2	6042227	pencil electrode G1/2 10m+hose KIT	1
2	6065196	pencil electrode G1/2 15m+hose KIT	1
3	6042229	double pencil electrode G1/2 10m KIT	1
3	6042228	double pencil electrode G1/2 20m KIT	1
3	6063536	double pencil electrode G1/2 40m KIT	1
3	6065157	double pencil electrode G1/2 10m 4*A KIT	1
3	6065156	double pencil electrode G1/2 20m 4*AWKIT	1
4	6068049	elbow pencil electrode G1/2 10m SET	1
4	6068050	elbow pencil electrode G1/2 15m SET	1
4	6075169	elbow pencil electrode G1/2 20m SET	1
5	6068345	elbow pencil electrode G1/2 10m+Schl. KI	1
5	6068346	elbow pencil electrode G1/2 15m+Schl. SE	1

CONTRACTOR'S PUMP KS16 (Bm4) UNIT

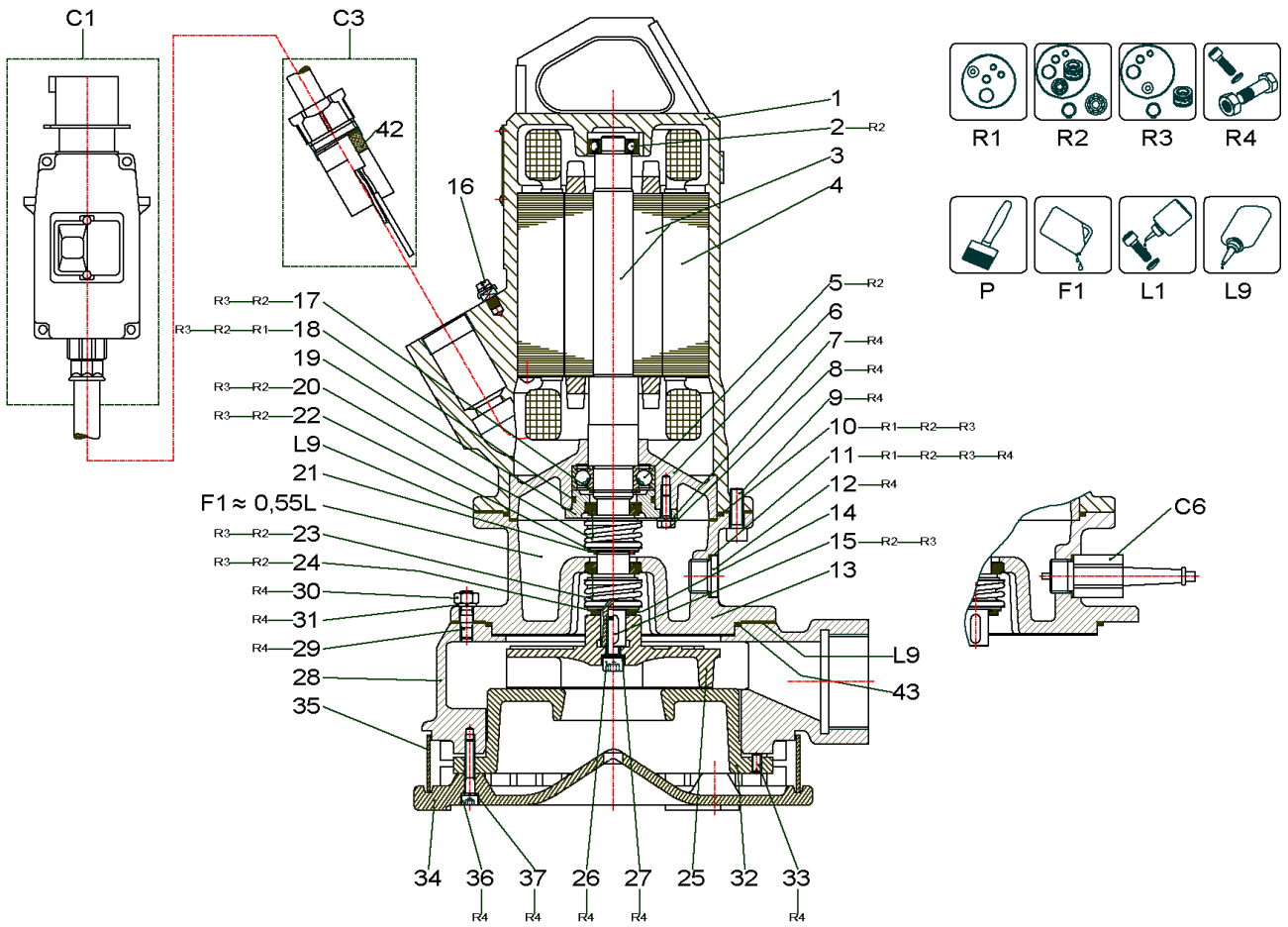

CONTRACTOR'S PUMP KS16 (Bm4) UNIT

Item	Article no.	Description	Quantity
R1	6016204	Rep.Kit 1 T12K, T12G BM2 / BM3 Vit	1
R2	6016074	Rep.Kit 2 T12K;T12G Bm2/Bm3 Vit	1
R3	6016073	Rep.Kit 3 T12K;T12G Bm2/Bm3 Vit	1
R4	6042219	Screws KS5,6,16/T12 KIT	1
P	6042254	PAINT SPRAY Pantone334	1
P	6023614	Ceram C0 black 100 ml KIT	1
P	6020579	Ceram C0 black 250 ml KIT	1
P	6023485	Ceram C0 Black 500ml Kit	1
P	6019157	Ceram C0 black 1000 ml KIT	1
F1	6025460	medical white oil 1L KIT	1
L1	6080531	Loctite 243 5g flask VP:	1
L1	2096167	Loctite 243 50ml VP.	1
L9	6080535	Loctite 5203 300ml VP.	1

C1		PLUG	1
C3		cable trumpet 30T KIT	1
C6		electrode KIT	1

1	6085138	motor casing 50.17232/2 GG VP.	1
2	6086141	ball bearing 6002 VP.	1
3	6010587	rotor D.61,4x320 2/11 1.4021 K	1
4	6023504	stator T12-2/11 400 50Hz VN01	1
5	2046946	ball bearing 6205/2RS-C3 (HT) VP.	1
6	6085141	bearing housing 53.17238 GG VP.	1
7		lock washer 6 DIN7980 A4	3
8		screw M6x16 DIN933 A2-70 (10pc)	1
9		screw M8x25 DIN912 A4 (10pc)	1
10		o-ring ID.125,0x3,0 Viton	1
11	6048832	joint ring A21/26x1,5 DIN7603 PA(10pc)	1
12	6067638	screw plug G1/2 DIN908 A4 (3pcs)	1
13	6047095	sealing casing D.152g6 52.20035 GG	1
14	6002118	washer 17 DIN433 A2	1
15	6004654	key A 6x4x18 54.2589 A4	1
16	6067407	Barlian bow terminal M5 A2	1

CONTRACTOR'S PUMP KS16 (Bm4) UNIT

Item	Article no.	Description	Quantity
17	6002002	circlips 25x1,2 DIN471 FSt	1
18		-ring ID.44,0x3,0 Viton 75	1
19	6085142	bearing cover D.35H7 53.17239 GG VP.	1
20	6074596	mechanical shaft seal MG1/20-G64 Q1Q1VGG	1
21	6005374	pressure ring 31,6x1 1.4571	1
22	6002006	circlips 20x1,2 DIN471 1.4116	1
23	6074596	mechanical shaft seal MG1/20-G64 Q1Q1VGG	1
24	6005374	pressure ring 31,6x1 1.4571	1
25	6021653	impeller-W D.134 54.18835 GG alternativ / alternative / alternative	1
25	6021748	impeller-W D.134 54.18835 GG	1
26	6003416	screw M8x25 DIN912 10.9 Geomet	1
27	6002688	screw locking Nord-Lock 13,5/8,7 A4	1
28	6044538	pump housing QG2 52.18831/1 GG alternativ / alternative / alternative	1
28	6044732	pump housing QG2 52.18831/1 GG/C0	1
29		screw M8x20 DIN939 A2-70	3
30		nut M8 DIN934 A2-80	3
31		lock washer 8 DIN7980 A4 (20pc)	1
32	6012778	suction port 52.14302 GG alternativ / alternative / alternative	1
32	6012777	suction port 52.14302 GG/C0	1
33		threaded pin M6x12 DIN551 A4	4
34	6017612	base plate D.250 52.14304 GG alternativ / alternative / alternative	1
34	6017603	base plate D.250 52.14304 GG/C0	1
35	6004794	strainer 36x234x2 1.4301	1
36		screw M6x35 ISO4762 A4-70	4
37		lock washer 6 DIN7980 A4	4
42	6076649	seal ring D.29,5/16x16,5 54.17777NBR VP.	1
42	6076651	seal ring D.29,5/19x16,5 54.17777NBR VP.	1
42	6076650	seal ring D.29,5/17x16,5 54.17777 NBR VP alternativ / alternative / alternative	1
42	6037031	seal ring D.29,5/16x16,5 CR silicon free	1

CONTRACTOR'S PUMP KS16 (Bm4) UNIT

Item	Article no.	Description	Quantity
42	6037478	seal ring D.29,5/19x16,5 CR silicon free	1
43	6007641	o-ring ID.150,0x3,0 Viton	1

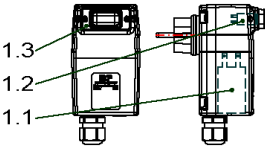
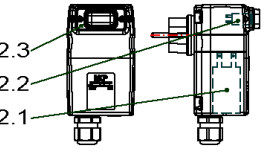
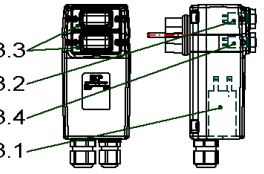
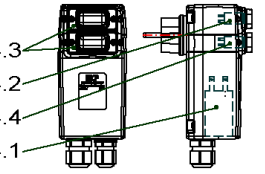
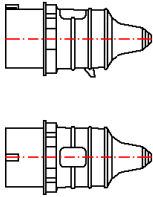
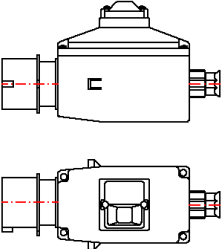
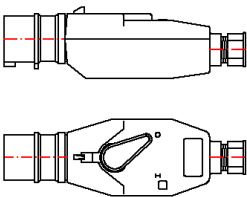
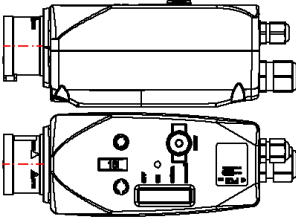
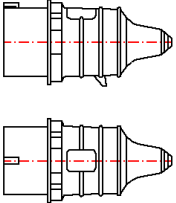
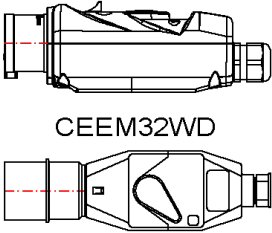
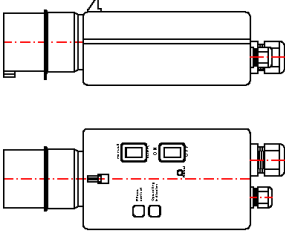
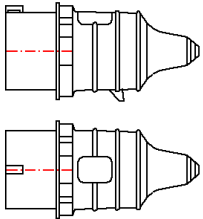
<p>1 MCP 6A-M-H-20μF ~ 230V</p>  <p>$I_N(230V / 50Hz) < 6A = 20\mu F$</p>	<p>2 MCP 10A-M-H-30μF ~ 230V</p>  <p>$I_N(230V / 50Hz) 6-10A = 30\mu F$</p>	<p>3 MCP 6A-M-HA-20μF ~ 230V</p>  <p>$I_N(230V / 50Hz) < 6A = 20\mu F$</p>	<p>4 MCP 10A-M-HA-30μF ~ 230V</p>  <p>$I_N(230V / 50Hz) 6-10A = 30\mu F$</p>
<p>5 CEE16A</p> 	<p>6 CEEM16W</p> 	<p>7 CEEM16WD</p> 	<p>8 MCP T4-HA-ROT-WSK CEE16-5PS</p> 
<p>9 CEE32A</p> 	<p>10 MCP 10-16A-T4-H-ROT CEE32-5PS</p>  <p>CEEM32WD</p>	<p>11 CEEM32WDSHA</p> 	<p>12 CEE63A</p> 

PLUG

Item	Article no.	Description	Quantity
		IN (230V / 50Hz) <6A - 20μF	
1	6072332	MCP 6A-M-H-20μF-CEE7/7 VP.	1
1.1	6071702	capacitor 400V 20μF MCP VP.	1
1.2	6071704	protection switch 6A MCP VP.	1
1.3	6071707	protecting cap MCP VP.	1
		IN (230V / 50Hz) 6-10A - 30μF	
2	6072330	MCP 10A-M-H-30μF-CEE7/7 VP.	1
2.1	6071703	capacitor 400V 30μF MCP VP.	1
2.2	6071705	protection switch 10A MCP VP.	1
2.3	6071707	protecting cap MCP VP.	1
		IN (230V / 50Hz) <6A - 20μF	
3	6072331	MCP 6A-M-HA-20μF-CEE7/7 VP.	1
3.1	6071702	capacitor 400V 20μF MCP VP.	1
3.2	6071704	protection switch 6A MCP VP.	1
3.3	6071707	protecting cap MCP VP.	2
3.4	6071706	switch on/out MCP VP.	1
		IN (230V / 50Hz) 6-10A - 30μF	
4	6072329	MCP 10A-M-HA-30μF-CEE7/7 VP	1
4.1	6071703	capacitor 400V 30μF MCP VP.	1
4.2	6071705	protection switch 10A MCP VP.	1
4.3	6071707	protecting cap MCP VP.	2
4.4	6071706	switch on/out MCP VP.	1
5	6003000	plug CEE16A/400V 60Hz/5P-11h	1
5	6003248	plug CEE16A/400V/4P-6H	1
5	6003009	plug CEE16A/400V/5P-6H	1
5	6039156	plug CEE16A/400V/5P-6H Phase inverter	1
5	6035231	plug CEE16A/400V/7P-6H	1
5	6003011	plug CEE16A/500V/5P-7H	1
6	6030883	plug MS400V5P CEE16A W 1,0-1,6A	1
6	6030884	plug MS400V5P CEE16A W 1,6-2,5A	1
6	6030888	plug MS400V5P CEE16A W 10,0-16,0A	1
6	6030885	plug MS400V5P CEE16A W 2,5-4,0A	1
6	6030886	plug MS400V5P CEE16A W 4,0-6,3A	1
6	6030887	plug MS400V5P CEE16A W 6,3-10,0A	1

PLUG

Item	Article no.	Description	Quantity
7	6032446	plug MS400V4P CEE16A WD 1,6-2,5A	1
7	6032447	plug MS400V4P CEE16A WD 12,5-16,0A	1
7	6032295	plug MS400V4P CEE16A WD 2,5-4,0A	1
7	6032289	plug MS400V4P CEE16A WD 4,0-6,3A	1
7	6032292	plug MS400V4P CEE16A WD 6,3-9,0A	1
7	6042190	plug MS400V5P CEE16A WDII 1,6-2,5A	1
7	6042194	plug MS400V5P CEE16A WDII 10,0-16,0A	1
7	6042191	plug MS400V5P CEE16A WDII 2,5-4,0A	1
7	6042192	plug MS400V5P CEE16A WDII 4,0-6,3A	1
7	6042193	plug MS400V5P CEE16A WDII 6,3-10,0A	1
7	6035911	plug MS400V5P CEE16A WD 9,0-12,5A	1
7	6003337	plug MS500V5P CEE16A WD 1,6-2,5A	1
7	6003336	plug MS500V5P CEE16A WD 2,5-4,0A	1
7	6003335	plug MS500V5P CEE16A WD 4,0-6,3A	1
7	6003334	plug MS500V5P CEE16A WD 6,3-9,0A	1
8	6072520	MCP 1,0-1,6A-T4-HA-ROT-WSK-CEE16-5PS VP.	1
8	6072521	MCP 1,6-2,4A-T4-HA-ROT-WSK-CEE16-5PS VP.	1
8	6072522	MCP 2,4-4,0A-T4-HA-ROT-WSK-CEE16-5PS VP.	1
8	6072523	MCP 4,0-6,0A-T4-HA-ROT-WSK-CEE16-5PS VP.	1
8	6072524	MCP 6,0-10A-T4-HA-ROT-WSK-CEE16-5PS VP.	1
8	6072525	MCP 9,0-12A-T4-HA-ROT-WSK-CEE16-5PS VP.	1
8	6072526	MCP 12-16A-T4-HA-ROT-WSK-CEE16-5PS VP.	1
9	6003267	plug CEE32A/400V/4P-6H	1
9	6039155	plug CEE32A/400V/5P-6H Phase inverter	1
9	6035895	plug CEE32A/500V/4P-7H AM-Top	1
9	6003010	plug CEE32A/500V/5P-7H	1
10	6072370	MCP 400V 1,6-2,5A-T4-H-ROT-CEE32-5PS VP.	1
10	6072369	MCP 400V 2,5-4,0A-T4-H-ROT-CEE32-5PS VP.	1
10	6072371	MCP 400V 4,0-6,3A-T4-H-ROT-CEE32-5PS VP.	1
10	6072398	MCP 400V 6,3-10A-T4-H-ROT-CEE32-5PS VP.	1
10	6072519	MCP 400V 10-16A-T4-H-ROT-CEE32-5PS VP.	1
10	6072399	MCP 400V 16-20A-T4-H-ROT-CEE32-5PS VP.	1
10	6072518	MCP 400V 20-25A-T4-H-ROT-CEE32-5PS VP.	1
10	6037649	plug.MS500V4P CEE32A WD 2,5-4,0A	1

PLUG

Item	Article no.	Description	Quantity
10	6041268	plug MS500V4P CEE32A WD 4,0-6,3A	1
10	6035244	plug MS500V5P CEE32A WD 1,6-2,5A	1
10	6034700	plug MS500V5P CEE32A WD 2,5-4,0A	1
10	6041556	plug MS500V5P CEE32A WD 4,0-6,3A	1
10	6002701	plug MS500V5P CEE32A WD 9,0-12,5A	1
10	6002700	plug MS500V5P CEE32A WD 12,5-16,0A	1
11	6003241	plug MS400V5P CEE32A WDSHA 10,0-14,0A	1
11	6003266	plug MS400V5P CEE32A WDSHA 3,7-5,5A	1
11	6003265	plug MS400V5P CEE32A WDSHA 5,5-8,0A	1
11	6003264	plug MS400V5P CEE32A WDSHA 8,0-11,5A	1
12	6003012	plug CEE63A/400V/5P-6H/IP67	1

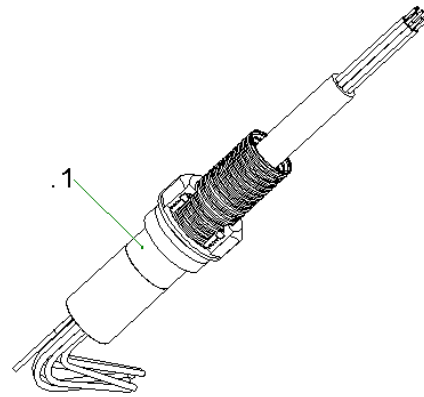
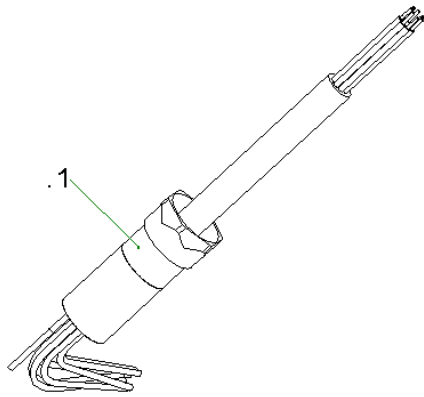

- 1 H07RN-F
- 2 NSSHOEU-J
- 3 SOOW

- 4 H07RN-F
- 5 NSSHOEU-J

cable trumpet 30T KIT

Item	Article no.	Description	Quantity
.1	6076649	seal ring D.29,5/16x16,5 54.17777NBR VP.	1
.1	6076651	seal ring D.29,5/19x16,5 54.17777NBR VP.	1
.1	6076650	seal ring D.29,5/17x16,5 54.17777 NBR VP	1
		alternativ / alternative / alternative	
.1	6037031	seal ring D.29,5/16x16,5 CR silicon free	1
.1	6037478	seal ring D.29,5/19x16,5 CR silicon free	1
1	6022379	cable trumpet 30T 5m H07 7G1,5 KIT	1
1	6019236	cable trumpet 30T 10m H07 7G1,5 KIT	1
1	6035928	cable trumpet 30T 15m H07 7G1,5 KIT	1
1	6060476	cable trumpet 30T 20m H07 7G1,5 KIT	1
1	6019164	cable trumpet 30T 25m H07 7G1,5 KIT	1
1	6060477	cable trumpet 30T 30m H07 7G1,5 KIT	1
1	6048268	cable trumpet 30T 35m H07 7G1,5 KIT	1
1	6060475	cable trumpet 30T 50m H07 7G1,5 KIT	1
1	6087356	cable trumpet 30T 10m H07 10G1,5 KIT	1
1	6041748	cable trumpet30T 15m H07 10G1,5 KIT	1
1	6080969	cable trumpet30T 20m H07 10G1,5 KIT	1
2	6031795	cable trumpet 30T 15m NSS 4x1,5 KIT	1
2	6040015	cable trumpet 30T 20m NSS 4x1,5 KIT	1
2	6035322	cable trumpet 30T 10m NSS 7x1,5 KIT	1
2	6028732	cable trumpet 30T 20m NSS 7x1,5 KIT	1
2	6026657	cable trumpet 30T 25m NSS 7x,1,5 KIT	1
2	6030434	cable trumpet 30T 15m NSS 7x2,5 KIT	1
3	6068166	cable trumpet 30T 10m 7* AWG 14 KIT	1
4	6042225	cable trumpet 30T 10m H07 7G1,5 C KIT	1
5	6042226	cable trumpet 30T 10m NSS 7x1,5 C KIT	1
5	6063462	cable trumpet 30T 15m NSS 7x1,5 C KIT	1
5	6063021	cable trumpet 30T 20m NSS 7x,1,5 C KIT	1

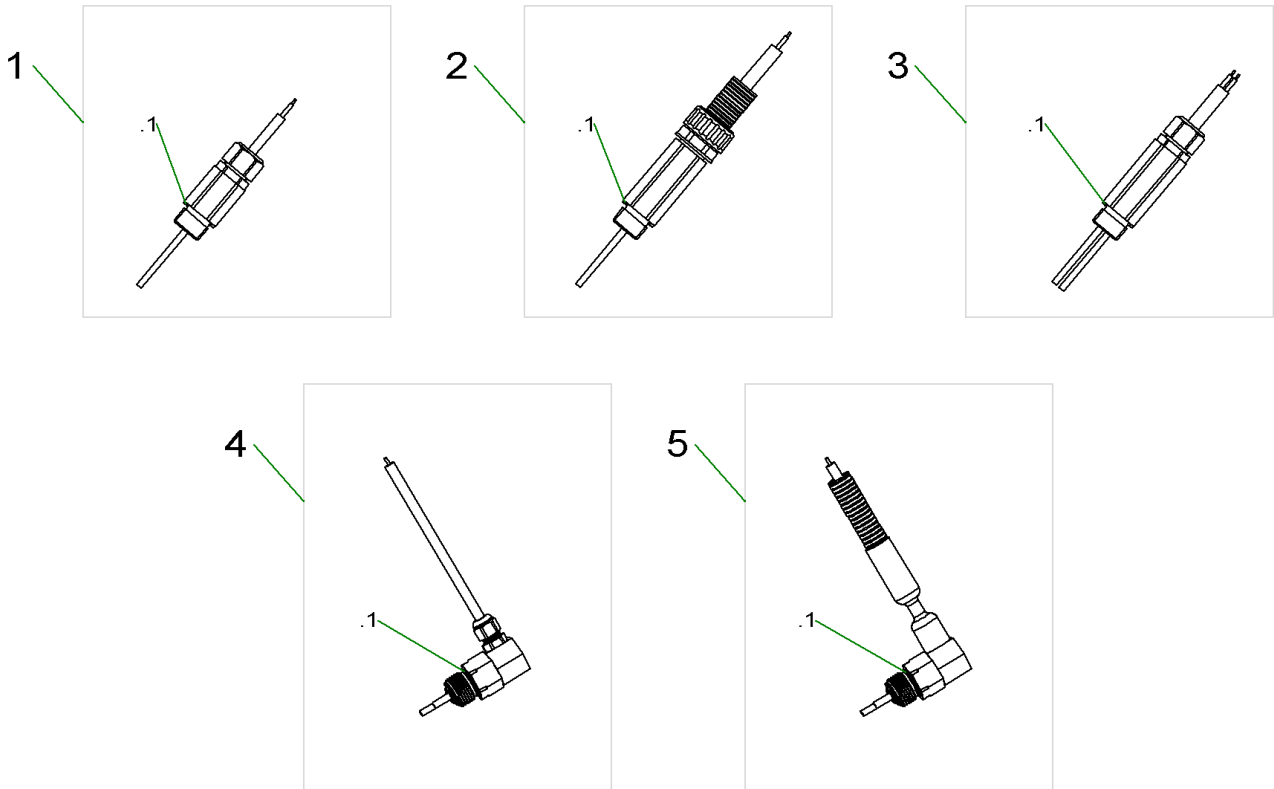

electrode KIT

Item	Article no.	Description	Quantity
.1	6048832	joint ring A21/26x1,5 DIN7603 PA(10pc)	1
1	6042222	pencil electrode G1/2 10m KIT	1
1	6042313	pencil electrode G1/2 15m KIT	1
1	6042223	pencil electrode G1/2 20m KIT	1
1	6061068	pencil electrode G1/2 25KIT	1
1	6061070	pencil electrode G1/2 30m KIT	1
1	6061069	Stabelektrode G1/2 40m SET	1
1	6060956	pencil electrode G1/2 55m KIT	1
2	6042227	pencil electrode G1/2 10m+hose KIT	1
2	6065196	pencil electrode G1/2 15m+hose KIT	1
3	6042229	double pencil electrode G1/2 10m KIT	1
3	6042228	double pencil electrode G1/2 20m KIT	1
3	6063536	double pencil electrode G1/2 40m KIT	1
3	6065157	double pencil electrode G1/2 10m 4*A KIT	1
3	6065156	double pencil electrode G1/2 20m 4*AWKIT	1
4	6068049	elbow pencil electrode G1/2 10m SET	1
4	6068050	elbow pencil electrode G1/2 15m SET	1
4	6075169	elbow pencil electrode G1/2 20m SET	1
5	6068345	elbow pencil electrode G1/2 10m+Schl. KI	1
5	6068346	elbow pencil electrode G1/2 15m+Schl. SE	1

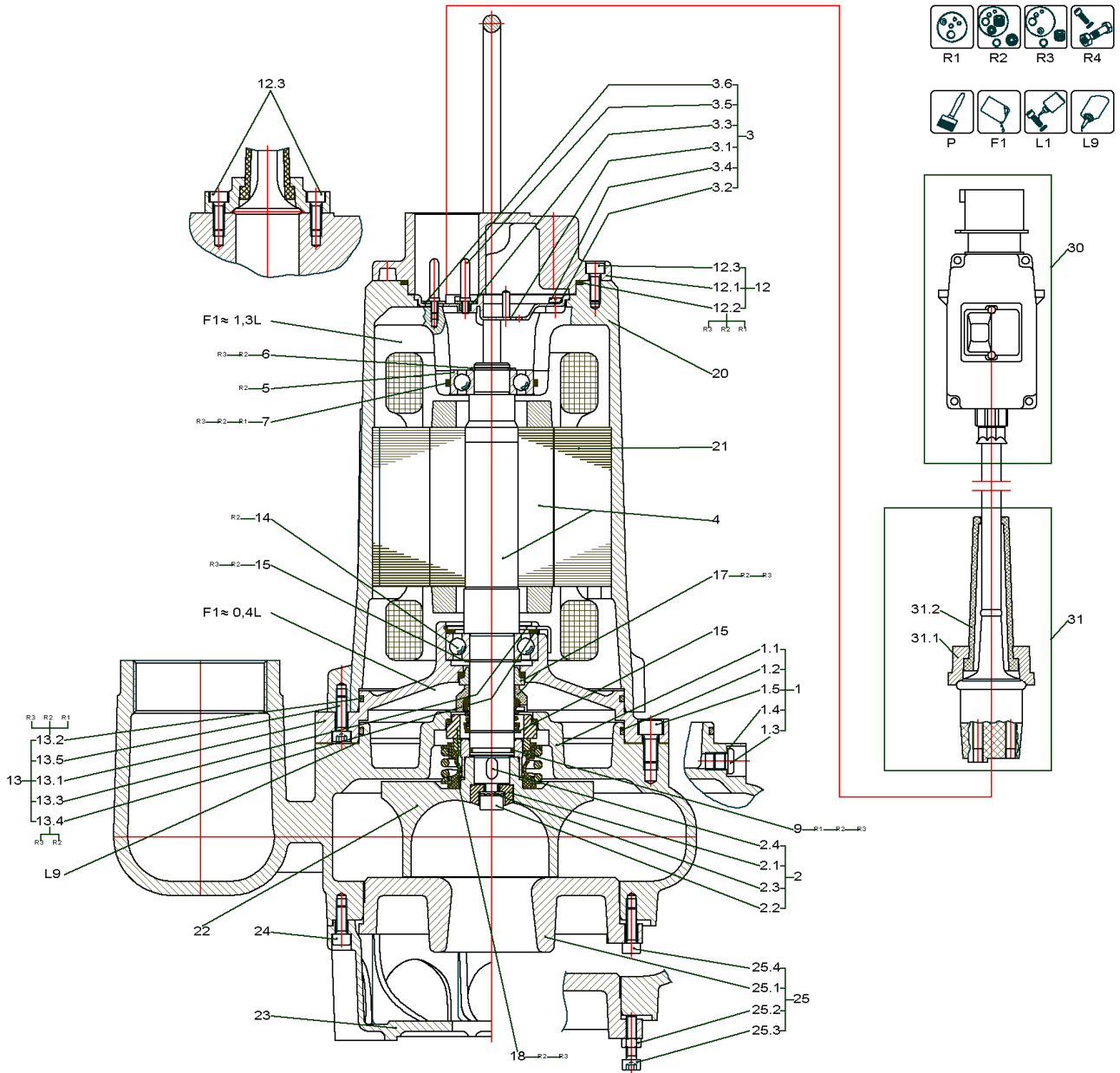

CONTRACTOR'S PUMP KS20 D GG (6042090)

Item	Article no.	Description	Quantity
R1	6016253	Rep.Kit 1 F13 Vit	1
R2	6016360	Rep.Kit 2 F13 Vit	1
R3	6016359	Rep.Kit 3 F13 Vit	1
R4	6001615	Screws FA45/F13 KIT	1
P	6042254	PAINT SPRAY Pantone334	1
P	6042255	colour 2K-paint IV80 pantone334C 250ml	1
F1	6025460	medical white oil 1L KIT	1
F1	6025461	medical white oil 5L KIT	1
L1	6080531	Loctite 243 5g flask VP:	1
L1	2096167	Loctite 243 50ml VP.	1
L9	6080535	Loctite 5203 300ml VP.	1

30	6030886	plug MS400V5P CEE16A W 4,0-6,3A	1
31	6072560	cable 10m H07 4G1,5/coupling VP.	1
31.1	6004828	cable gland Akulon	1
31.2	6003824	cable peotection NBR 87x30 mm	1

12	6027182	motor cover D.95g6 52.2831 GG KIT	1
12.1		> motor cover D.95g6 52.2831 GG	1
12.2		> o-ring ID.92,0x3,0 Viton	1
12.3	6003428	> screw M6x16 ISO4762 A4	8
20	6013893	motor casing 51.2641/1 GG	1
3	6001273	terminal board 54.3453 Makrolon KIT	1
3.1		> terminal board plastics Polycarbonat	1
3.5		> contact pin Ms	4
3.2		> lock washer 4 DIN7980 A4	1
3.3		> washer A4,3 DIN125 Ms	5
3.4		> screw M4x8 DIN84 Ms	1
3.6		> washer 4,3 DIN7349 Ms	1
21	6001616	stator F13-2/9 230/400V 50Hz	1
4	6009987	rotor D.69,4x237,5 2+4/9 1.4021	1
5	6008996	ball bearing 6204 with 2 shield	1
6	6002006	circlips 20x1,2 DIN471 1.4116	1
7		o-ring ID.47,0x3,0 Viton 80	1

CONTRACTOR'S PUMP KS20 D GG (6042090)

Item	Article no.	Description	Quantity
9	6008922	o-ring ID.22,0x2,0 Viton	1
13	6019842	bearing housing 52.2111 GG KIT	1
13.1		> bearing housing 52.2111VN00 GG	1
13.2		> o-ring ID.142,0x3,0 Viton 80	1
13.3	6004660	> circlips 54x1,8 55.2107 FSt	1
13.4		> washer D.42/52x2,5 DIN988 St	1
13.5	6080473	> screw M6x20 DIN912 A2-70 (10pc)	1
14	6008995	ball bearing 6205 no shield no grease	1
15	6002002	circlips 25x1,2 DIN471 FSt	2
17	6004190	mechanical shaft seal M1S13/25-00-R-BEPG	1
18	6075380	mechanical shaft seal MG1/35-G4 Q1Q1VGG	1
1	6001145	pump housing A G2½ 51.2144/1 GG KIT	1
1.1		> pump housing A G21/2 51.2144/1 GG	1
1.2	6007643	> o-ring ID.142,0x3,0 Viton 80	1
1.3	6002430	> screw plug G1/8 DIN908 A2	1
1.4	6007524	> seal ring A10/13,5x1,5 DIN7603 PA	1
1.5	6003412	> screw M8x16 ISO4762 A2-70	4
22	6014516	impeller-E D.125 52.2146 GGG	1
2	6001274	impeller fixation 55.2105 KIT	1
2.1		> washer D.24/9x11.5 55.2105	1
2.2		> screw M8x20 DIN912 10.9 Geomet	1
2.3		> screw locking Nord-Lock 13,5/8,7 A4	1
2.4		> key A 6x4x12 DIN6885 A4	1
23	6017626	suction hose 52. 2143 GGG	1
24	6080174	screw M6x16 DIN912 A4 (10pc)	1
25	6000672	suction port 53.2160/1 GG KIT	1
25.1		> suction port 53.2160/1 GG	1
25.2	6002384	> nut M6 DIN934 A4-80	2
25.3	6003424	> screw M6x25 ISO4762 A2-70	2
25.4	6080473	> screw M6x20 DIN912 A2-70 (10pc)	1

CONTRACTOR'S PUMP KS20 DS GG (6042091)

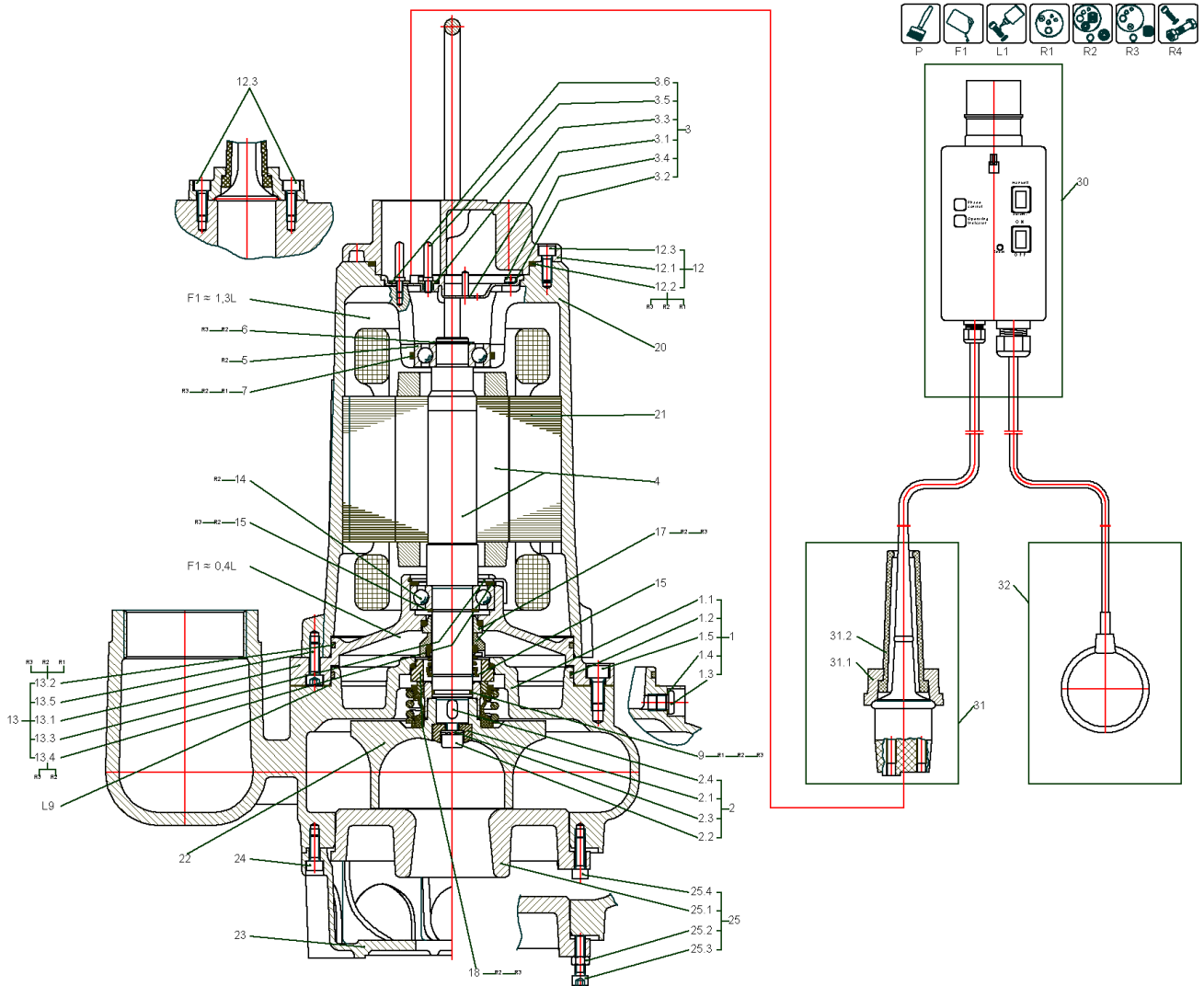

CONTRACTOR'S PUMP KS20 DS GG (6042091)

Item	Article no.	Description	Quantity
R1	6016253	Rep.Kit 1 F13 Vit	1
R2	6016360	Rep.Kit 2 F13 Vit	1
R3	6016359	Rep.Kit 3 F13 Vit	1
R4	6001615	Screws FA45/F13 KIT	1
P	6042254	PAINT SPRAY Pantone334	1
P	6042255	colour 2K-paint IV80 pantone334C 250ml	1
F1	6025460	medical white oil 1L KIT	1
F1	6025461	medical white oil 5L KIT	1
L1	6080531	Loctite 243 5g flask VP:	1
L1	2096167	Loctite 243 50ml VP.	1
L9	6080535	Loctite 5203 300ml VP.	1

30	6072523	MCP 4,0-6,0A-T4-HA-ROT-WSK-CEE16-5PS VP.	1
31	6072560	cable 10m H07 4G1,5/coupling VP.	1
31.1	6004828	cable gland Akulon	1
31.2	6003824	cable peotection NBR 87x30 mm	1
32	6072582	float switch S-PS 10A 250V 10m NO VP	1

12	6027182	motor cover D.95g6 52.2831 GG KIT	1
12.1		> motor cover D.95g6 52.2831 GG	1
12.2		> o-ring ID.92,0x3,0 Viton	1
12.3	6003428	> screw M6x16 ISO4762 A4	8
20	6013893	motor casing 51.2641/1 GG	1
3	6001273	terminal board 54.3453 Makrolon KIT	1
3.1		> terminal board plastics Polycarbonat	1
3.5		> contact pin Ms	4
3.2		> lock washer 4 DIN7980 A4	1
3.3		> washer A4,3 DIN125 Ms	5
3.4		> screw M4x8 DIN84 Ms	1
3.6		> washer 4,3 DIN7349 Ms	1
21	6001616	stator F13-2/9 230/400V 50Hz	1
4	6009987	rotor D.69,4x237,5 2+4/9 1.4021	1
5	6008996	ball bearing 6204 with 2 shield	1
6	6002006	circlips 20x1,2 DIN471 1.4116	1

CONTRACTOR'S PUMP KS20 DS GG (6042091)

Item	Article no.	Description	Quantity
7		o-ring ID.47,0x3,0 Viton 80	1
9	6008922	o-ring ID.22,0x2,0 Viton	1
13	6019842	bearing housing 52.2111 GG KIT	1
13.1		> bearing housing 52.2111VN00 GG	1
13.2		> o-ring ID.142,0x3,0 Viton 80	1
13.3	6004660	> circlips 54x1,8 55.2107 FSt	1
13.4		> washer D.42/52x2,5 DIN988 St	1
13.5	6080473	> screw M6x20 DIN912 A2-70 (10pc)	1
14	6008995	ball bearing 6205 no shield no grease	1
15	6002002	circlips 25x1,2 DIN471 FSt	2
17	6004190	mechanical shaft seal M1S13/25-00-R-BEPG	1
18	6075380	mechanical shaft seal MG1/35-G4 Q1Q1VGG	1
1	6001145	pump housing A G2½ 51.2144/1 GG KIT	1
1.1		> pump housing A G21/2 51.2144/1 GG	1
1.2	6007643	> o-ring ID.142,0x3,0 Viton 80	1
1.3	6002430	> screw plug G1/8 DIN908 A2	1
1.4	6007524	> seal ring A10/13,5x1,5 DIN7603 PA	1
1.5	6003412	> screw M8x16 ISO4762 A2-70	4
22	6014516	impeller-E D.125 52.2146 GGG	1
2	6001274	impeller fixation 55.2105 KIT	1
2.1		> washer D.24/9x11.5 55.2105	1
2.2		> screw M8x20 DIN912 10.9 Geomet	1
2.3		> screw locking Nord-Lock 13,5/8,7 A4	1
2.4		> key A 6x4x12 DIN6885 A4	1
23	6017626	suction hose 52. 2143 GGG	1
24	6080174	screw M6x16 DIN912 A4 (10pc)	1
25	6000672	suction port 53.2160/1 GG KIT	1
25.1		> suction port 53.2160/1 GG	1
25.2	6002384	> nut M6 DIN934 A4-80	2
25.3	6003424	> screw M6x25 ISO4762 A2-70	2
25.4	6080473	> screw M6x20 DIN912 A2-70 (10pc)	1

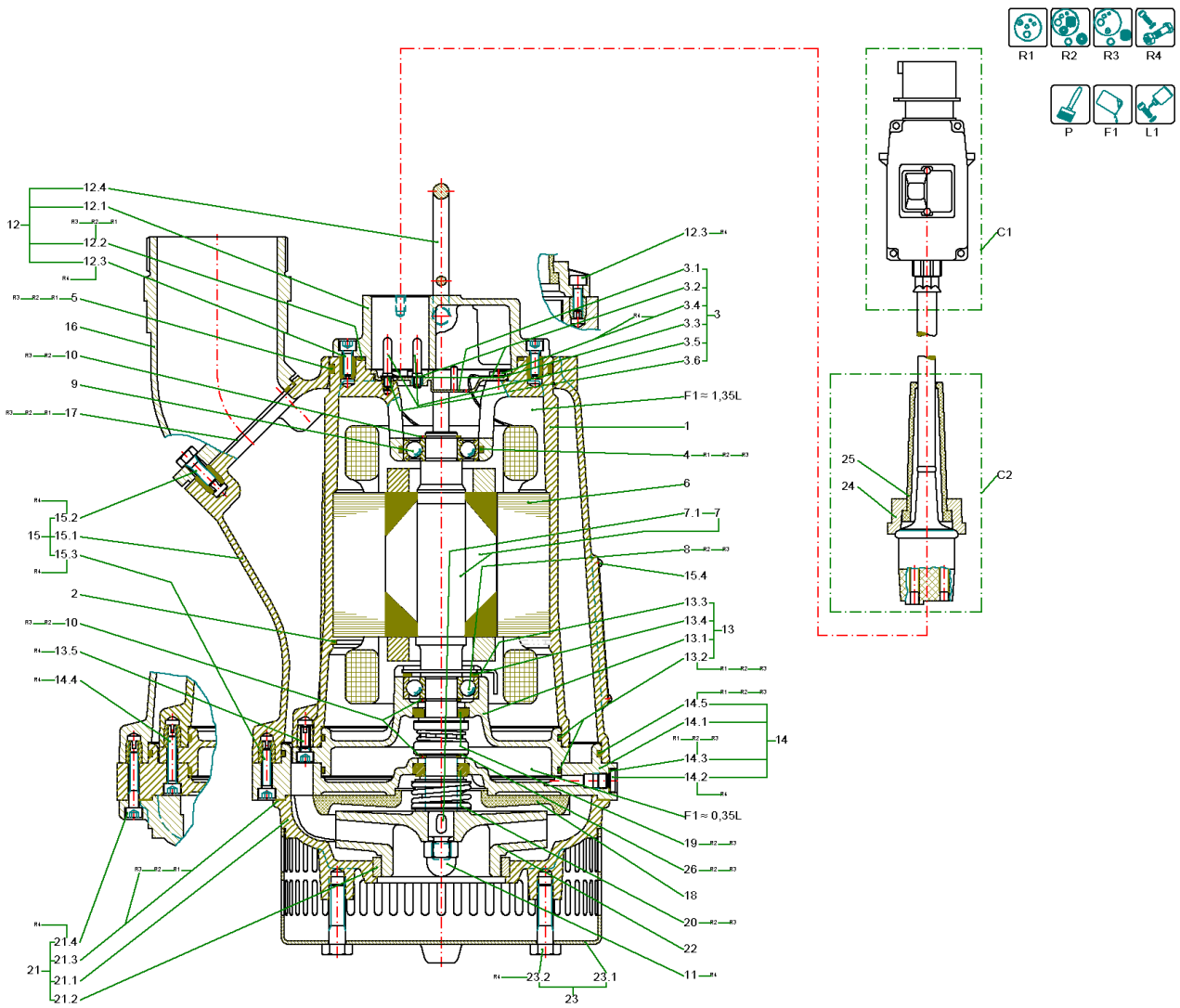

CONTRACTOR'S PUMP KS24 UNIT (6000096)

Item	Article no.	Description	Quantity
R1	6016275	Rep.Kit 1 KS24 Vit	1
R2	6016313	Rep.Kit 2 KS24 Vit	1
R3	6016312	Rep.Kit 3 KS24 Vit	1
R4	6016130	Screws KS24 KIT	1
P	6042254	PAINT SPRAY Pantone334	1
P	6042255	colour 2K-paint IV80 pantone334C 250ml	1
P	6023614	Ceram C0 black 100 ml KIT	1
P	6020579	Ceram C0 black 250 ml KIT	1
P	6023485	Ceram C0 Black 500ml Kit	1
P	6019157	Ceram C0 black 1000 ml KIT	1
F1	6025460	medical white oil 1L KIT	1
F1	6025461	medical white oil 5L KIT	1
L1	6080531	Loctite 243 5g flask VP:	1
L1	2096167	Loctite 243 50ml VP.	1

C1		PLUG	1

C2		cable for motor F12 / F13	1
1	6033647	motor casing 51.2844/3 Al	1
2	6033646	circlips SB135 FSt	1
3	6001273	terminal board 54.3453 Makrolon KIT	1
3.1		> terminal board plastics Polycarbonat	1
3.5		> contact pin Ms	4
3.2		> lock washer 4 DIN7980 A4	1
3.3		> washer A4,3 DIN125 Ms	5
3.4		> screw M4x8 DIN84 Ms	1
3.6		> washer 4,3 DIN7349 Ms	1
4		o-ring ID.47,0x3,0 Viton 80	1
5		o-ring ID.130,0x4,0 Viton 80	1
6	6001616	stator F13-2/9 230/400V 50Hz	1
		alternativ / alternative / alternative	
6	6023516	stator F13-2/9 500 50Hz VN01	1
6	6023517	stator F13-2/9 415 50Hz VN01	1
7	6022254	rotor F13.1 KIT	1

CONTRACTOR'S PUMP KS24 UNIT (6000096)

Item	Article no.	Description	Quantity
7		> rotor D.69,4x267 2/9 1.4021	1
7.1	6004692	> key A 6x4x12 DIN6885 A4	1
8	6008997	ball bearing 6204 no shield no grease	1
9	6008996	ball bearing 6204 with 2 shield	1
10	6002006	circlips 20x1,2 DIN471 1.4116	3
11	6002101	domet nut M12 DIN1587 A2	1
12	6024814	motor cover D.95g6 52.2831 Al KIT	1
12.1		> motor cover D.95g6 52.2831 Al	1
12.2		> o-ring ID.92,0x3,0 Viton	1
12.3		> screw M6x16 DIN912 A4 (10pc)	1
12.4		handle 54.2829 A2	1
Note: für Pumpengehäuse Abrasit / for pump housing Abrasit / pour corps de pompe Abrasit			
13	6001297	bearing housing 52.2834 Al KIT	1
13.1		> bearing housing 52.2834 Al	1
13.2		> o-ring ID.142,0x3,0 Viton 80	2
13.3	6004673	> circlips 49x1,8 55.2828 FSt	1
13.4	6002157	> washer D.37/47x2,5 DIN988 St	1
13.5		> screw M6x16 DIN912 A4 (10pc)	1
14	6001298	sealing flange 52.2842 Al KIT	1
14.1		> sealing flange D.195H7 52. 2842 Al	1
14.2	6002430	> screw plug G1/8 DIN908 A2	1
14.3	6007524	> seal ring A10/13,5x1,5 DIN7603 PA	1
14.4		> SCREW M6X30 ISO4762 A2-70	3
14.5		> o-ring ID.192,0x3,0 Viton 80	1
		alternativ / alternative / alternative	
14.1	6019024	sealing flange D.195H7 52.2842 Al/C0	1
15	6001375	pump shroud SG3 51.2841 Al KIT	1
15.1		> pump shroud SG3 51.2841 Al	1
15.2		> screw M8x20 ISO4017 A2-70	4
15.3		> screw M6x25 ISO4762 A2-70	3
15.4		> round-headed notched nail 3x5 ISO8746 A2	4
		alternativ / alternative / alternative	
15.1	6001788	pump shroud SG351.2841 GAISi/C0	1
15.1	6019651	pump shroud SG3 51.2841 GAISi/C1C1	1

CONTRACTOR'S PUMP KS24 UNIT (6000096)

Item	Article no.	Description	Quantity
24	6004828	cable gland Akulon	1
25	6003824	cable protection NBR 87x30 mm	1
16	6012679	discharge piece G3 53.2848 GGG	1
		alternativ / alternative / alternative	
16	6001789	discharge piece G3 53.2848 GGG/C0	1
17	6004236	flat gasket D.75/90x2 55.2824 Alwit	1
18	6075813	wear plate 53.2789 CR70 VP.	1
19	6075390	mechan. shaft seal 0200/T2100/L3S/BR1 VP	1
		alternativ / alternative / alternative	
19	6074596	mechanical shaft seal MG1/20-G64 Q1Q1VGG	1
26	6005374	pressure ring 31,6x1 1.4571	1
20	6074596	mechanical shaft seal MG1/20-G64 Q1Q1VGG	1
21	6001109	pump housing A 51.2708 GG KIT	1
21.1		> pump housing A 51.2708 GG	1
21.2		> neck ring D.85x12 6051845 1.4470	1
21.3	6074583	> flat gasket D.195/210 ARAMID/NBR (10pc)	1
21.4		> screw M6x35 ISO4762 A4-70	3
21.2	6073151	neck ring D.85x12 6051845 1.4470 VP.	1
		alternativ / alternative / alternative	
21.1	6001769	pump housing A GG/C0 51.2708	1
21.1	6021682	pump housing A 51.2708 GG/C1C1	1
21.1	6012857	pump housing A 51.2708 GG/C2C1	1
21.1	6024252	pump housing A 52.19194 Abrasit	1
21.4	6043289	screw M6x40 DIN912 A4-70	3
Note: für Pumpengehäuse Abrasit / for pumphousing Abrasit / pour corps de pompe			
21.1	6024253	pump housing A 52.19194 Abrasit/C0	1
21.1	6012910	pump housing A 51.16784 1.4581	1
		Lauftrad / Impeller / Roue 50Hz	
22	6013997	impeller -M D.132 53.2858 GGG	1
		alternativ / alternative / alternative	
22	6001400	impeller-M D.132 53.2858 GGG/C0	1
22	6013995	impeller -M D.132 53.2858 GGG/C2/C1	1
22	6010618	impeller-M D.132 53.17906 Abrasit	1
22	6024245	impeller-M D.132 53.17906 Abrasit/CO	1

CONTRACTOR'S PUMP KS24 UNIT (6000096)

Item	Article no.	Description	Quantity
22	6013996	impeller -M D.132 53.2858 1.4581 Lauftrad / Impeller / Roue 60Hz	1
22	6013998	impeller-M D.124 53.2838 GGG alternativ / alternative / alternative	1
22	6021760	impeller-M D.124 53.2838 GGG/C0	1
22	6021761	impeller-M D.124 53.2838 GGG/C2C1	1
22	6022792	impeller-M D.124 53.17906 Abrasit	1
22	6024246	impeller-M D.124 53.17906 Abrasit/CO	1
22	6021649	impeller-M D.124 53.2838 1.4581	1
23	6001108	suction hose KS24 1.4301 KIT	1
23.1		> suction hose 6051651 1.4301	1
23.2		> screw M10x40 DIN931 A2-70	2

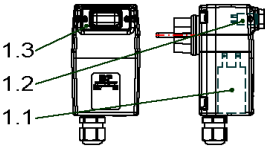
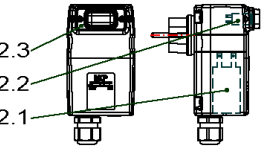
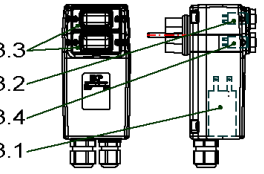
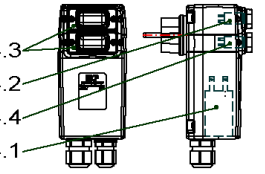
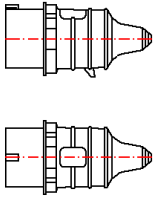
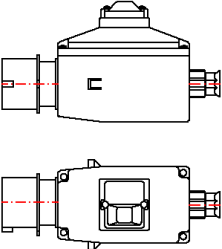
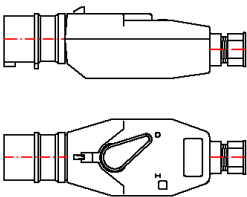
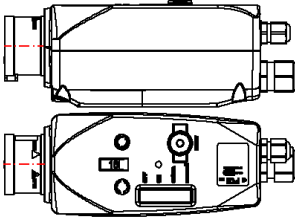
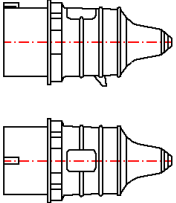
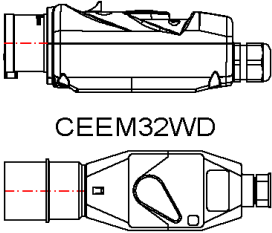
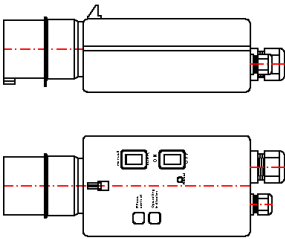
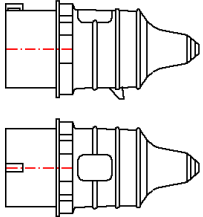
<p>1 MCP 6A-M-H-20μF ~ 230V</p>  <p>$I_N(230V / 50Hz) < 6A = 20\mu F$</p>	<p>2 MCP 10A-M-H-30μF ~ 230V</p>  <p>$I_N(230V / 50Hz) 6-10A = 30\mu F$</p>	<p>3 MCP 6A-M-HA-20μF ~ 230V</p>  <p>$I_N(230V / 50Hz) < 6A = 20\mu F$</p>	<p>4 MCP 10A-M-HA-30μF ~ 230V</p>  <p>$I_N(230V / 50Hz) 6-10A = 30\mu F$</p>
<p>5 CEE16A</p> 	<p>6 CEEM16W</p> 	<p>7 CEEM16WD</p> 	<p>8 MCP T4-HA-ROT-WSK CEE16-5PS</p> 
<p>9 CEE32A</p> 	<p>10 MCP 10-16A-T4-H-ROT CEE32-5PS</p>  <p>CEEM32WD</p>	<p>11 CEEM32WDSHA</p> 	<p>12 CEE63A</p> 

PLUG

Item	Article no.	Description	Quantity
		IN (230V / 50Hz) <6A - 20μF	
1	6072332	MCP 6A-M-H-20μF-CEE7/7 VP.	1
1.1	6071702	capacitor 400V 20μF MCP VP.	1
1.2	6071704	protection switch 6A MCP VP.	1
1.3	6071707	protecting cap MCP VP.	1
		IN (230V / 50Hz) 6-10A - 30μF	
2	6072330	MCP 10A-M-H-30μF-CEE7/7 VP.	1
2.1	6071703	capacitor 400V 30μF MCP VP.	1
2.2	6071705	protection switch 10A MCP VP.	1
2.3	6071707	protecting cap MCP VP.	1
		IN (230V / 50Hz) <6A - 20μF	
3	6072331	MCP 6A-M-HA-20μF-CEE7/7 VP.	1
3.1	6071702	capacitor 400V 20μF MCP VP.	1
3.2	6071704	protection switch 6A MCP VP.	1
3.3	6071707	protecting cap MCP VP.	2
3.4	6071706	switch on/out MCP VP.	1
		IN (230V / 50Hz) 6-10A - 30μF	
4	6072329	MCP 10A-M-HA-30μF-CEE7/7 VP	1
4.1	6071703	capacitor 400V 30μF MCP VP.	1
4.2	6071705	protection switch 10A MCP VP.	1
4.3	6071707	protecting cap MCP VP.	2
4.4	6071706	switch on/out MCP VP.	1
5	6003000	plug CEE16A/400V 60Hz/5P-11h	1
5	6003248	plug CEE16A/400V/4P-6H	1
5	6003009	plug CEE16A/400V/5P-6H	1
5	6039156	plug CEE16A/400V/5P-6H Phase inverter	1
5	6035231	plug CEE16A/400V/7P-6H	1
5	6003011	plug CEE16A/500V/5P-7H	1
6	6030883	plug MS400V5P CEE16A W 1,0-1,6A	1
6	6030884	plug MS400V5P CEE16A W 1,6-2,5A	1
6	6030888	plug MS400V5P CEE16A W 10,0-16,0A	1
6	6030885	plug MS400V5P CEE16A W 2,5-4,0A	1
6	6030886	plug MS400V5P CEE16A W 4,0-6,3A	1
6	6030887	plug MS400V5P CEE16A W 6,3-10,0A	1

PLUG

Item	Article no.	Description	Quantity
7	6032446	plug MS400V4P CEE16A WD 1,6-2,5A	1
7	6032447	plug MS400V4P CEE16A WD 12,5-16,0A	1
7	6032295	plug MS400V4P CEE16A WD 2,5-4,0A	1
7	6032289	plug MS400V4P CEE16A WD 4,0-6,3A	1
7	6032292	plug MS400V4P CEE16A WD 6,3-9,0A	1
7	6042190	plug MS400V5P CEE16A WDII 1,6-2,5A	1
7	6042194	plug MS400V5P CEE16A WDII 10,0-16,0A	1
7	6042191	plug MS400V5P CEE16A WDII 2,5-4,0A	1
7	6042192	plug MS400V5P CEE16A WDII 4,0-6,3A	1
7	6042193	plug MS400V5P CEE16A WDII 6,3-10,0A	1
7	6035911	plug MS400V5P CEE16A WD 9,0-12,5A	1
7	6003337	plug MS500V5P CEE16A WD 1,6-2,5A	1
7	6003336	plug MS500V5P CEE16A WD 2,5-4,0A	1
7	6003335	plug MS500V5P CEE16A WD 4,0-6,3A	1
7	6003334	plug MS500V5P CEE16A WD 6,3-9,0A	1
8	6072520	MCP 1,0-1,6A-T4-HA-ROT-WSK-CEE16-5PS VP.	1
8	6072521	MCP 1,6-2,4A-T4-HA-ROT-WSK-CEE16-5PS VP.	1
8	6072522	MCP 2,4-4,0A-T4-HA-ROT-WSK-CEE16-5PS VP.	1
8	6072523	MCP 4,0-6,0A-T4-HA-ROT-WSK-CEE16-5PS VP.	1
8	6072524	MCP 6,0-10A-T4-HA-ROT-WSK-CEE16-5PS VP.	1
8	6072525	MCP 9,0-12A-T4-HA-ROT-WSK-CEE16-5PS VP.	1
8	6072526	MCP 12-16A-T4-HA-ROT-WSK-CEE16-5PS VP.	1
9	6003267	plug CEE32A/400V/4P-6H	1
9	6039155	plug CEE32A/400V/5P-6H Phase inverter	1
9	6035895	plug CEE32A/500V/4P-7H AM-Top	1
9	6003010	plug CEE32A/500V/5P-7H	1
10	6072370	MCP 400V 1,6-2,5A-T4-H-ROT-CEE32-5PS VP.	1
10	6072369	MCP 400V 2,5-4,0A-T4-H-ROT-CEE32-5PS VP.	1
10	6072371	MCP 400V 4,0-6,3A-T4-H-ROT-CEE32-5PS VP.	1
10	6072398	MCP 400V 6,3-10A-T4-H-ROT-CEE32-5PS VP.	1
10	6072519	MCP 400V 10-16A-T4-H-ROT-CEE32-5PS VP.	1
10	6072399	MCP 400V 16-20A-T4-H-ROT-CEE32-5PS VP.	1
10	6072518	MCP 400V 20-25A-T4-H-ROT-CEE32-5PS VP.	1
10	6037649	plug.MS500V4P CEE32A WD 2,5-4,0A	1

PLUG

Item	Article no.	Description	Quantity
10	6041268	plug MS500V4P CEE32A WD 4,0-6,3A	1
10	6035244	plug MS500V5P CEE32A WD 1,6-2,5A	1
10	6034700	plug MS500V5P CEE32A WD 2,5-4,0A	1
10	6041556	plug MS500V5P CEE32A WD 4,0-6,3A	1
10	6002701	plug MS500V5P CEE32A WD 9,0-12,5A	1
10	6002700	plug MS500V5P CEE32A WD 12,5-16,0A	1
11	6003241	plug MS400V5P CEE32A WDSHA 10,0-14,0A	1
11	6003266	plug MS400V5P CEE32A WDSHA 3,7-5,5A	1
11	6003265	plug MS400V5P CEE32A WDSHA 5,5-8,0A	1
11	6003264	plug MS400V5P CEE32A WDSHA 8,0-11,5A	1
12	6003012	plug CEE63A/400V/5P-6H/IP67	1

cable for motor F12 / F13

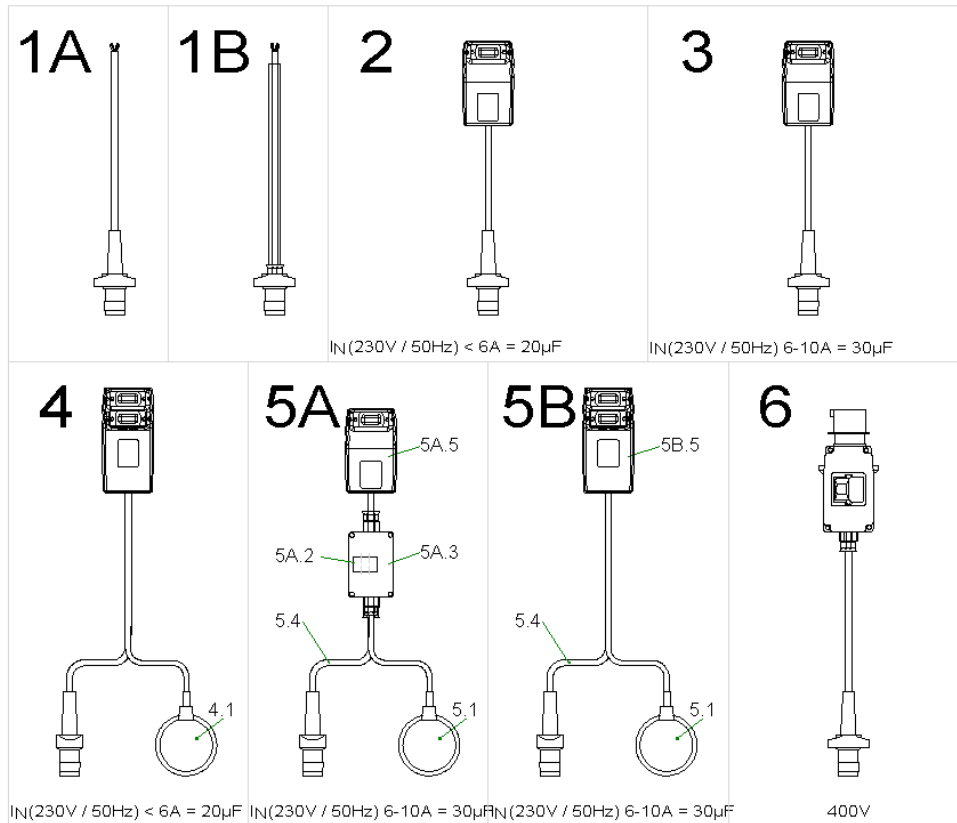

cable for motor F12 / F13

Item	Article no.	Description	Quantity
1A	6072559	cable 5m H07 4G1,5/coupling VP.	1
1A	6072560	cable 10m H07 4G1,5/coupling VP.	1
1A	6072561	cable 20m H07 4G1,5/coupling VP.	1
1A	6072562	cable 30m H07 4G1,5/coupling VP.	1
1A	6072563	cable 40m H07 4G1,5/coupling VP.	1
1A	6087533	cable 40m H07 4G1,5/coupling VP.	1
1B	6072564	cable 10m H07 4G1,5/coupl./hose VP. IN (230V / 50Hz) <6A - 20µF	1
2	6072565	switch box MCP 6A H 5M VP.	1
2	6072566	switch box MCP 6A H 10M VP.	1
2	6072567	switch box MCP 6A H 20M VP. IN (230V / 50Hz) 6-10A - 30µF	1
3	6072568	switch box MCP 10A H 5M VP.	1
3	6072569	switch box MCP 10A H 10M VP.	1
3	6072570	switch box MCP 10A H 20M VP. IN (230V / 50Hz) <6A - 20µF	1
4	6072571	switch box MCP 6A HA 5M VP.	1
4	6072572	switch box MCP 6A HA 10M VP.	1
4.1	6072582	float switch S-PS 10A 250V 10m NO VP	1
4	6072576	switch box MCP 6A HA 20M VP.	1
4.1	6072583	float switch S-PS 10A 250V 20m NO VP IN (230V / 50Hz) 6-10A - 30µF	1
5A		on request	1
5B	6072577	switch box MCP 10A HA 10M	1
5.1	6072582	float switch S-PS 10A 250V 10m NO VP	1
5A.2	6003341	contactor 5,5 kW 230 V, 50 Hz	1
5A.3	6031509	blank casing KS12/15ES KIT	1
5.4	6072560	cable 10m H07 4G1,5/coupling VP.	1
5A.5	6072330	MCP 10A-M-H-30µF-CEE7/7 VP.	1
5B.5	6072329	MCP 10A-M-HA-30µF-CEE7/7 VP für / for / pour 400V	1
6	6023991	switch box CEEM16W 2,5A, 10m SVA	1
6	6001253	switch box CEEM16W 4A, 10m SVA	1
6	6023992	switch box CEEM16W 6,3A, 20m SVA	1

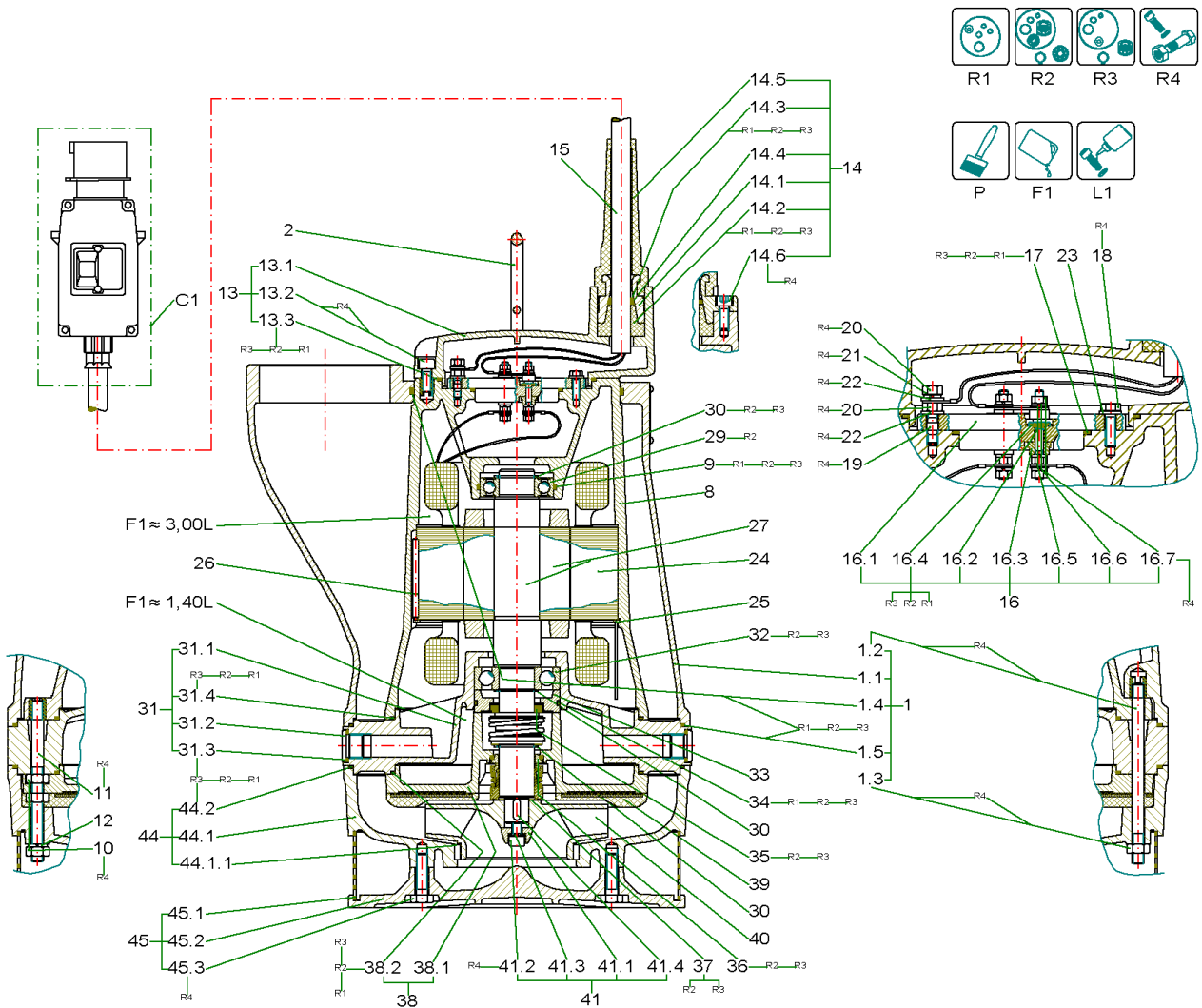

CONTRACTOR'S PUMP KS37H UNIT (6000098)

Item	Article no.	Description	Quantity
R1	6016259	Rep.Kit 1 KS37,70+Z Vit	1
R2	6016303	Rep.Kit 2 KS37,70 +Z Vit	1
R3	6016304	Rep.Kit 3 KS37,70+Z Vit	1
R4	6016128	Screws KS37,70 + Z KIT	1
P	6042254	PAINT SPRAY Pantone334	1
P	6042255	colour 2K-paint IV80 pantone334C 250ml	1
P	6023614	Ceram C0 black 100 ml KIT	1
P	6020579	Ceram C0 black 250 ml KIT	1
P	6023485	Ceram C0 Black 500ml Kit	1
P	6019157	Ceram C0 black 1000 ml KIT	1
F1	6025461	medical white oil 5L KIT	1
F1	6025460	medical white oil 1L KIT	1
L1	6080531	Loctite 243 5g flask VP:	1
L1	2096167	Loctite 243 50ml VP.	1

C1		PLUG	1

1		pump shroud SG4 1694 Al KIT	1
Note: nicht mehr lieferbar / no longer available / ne plus disponible			
1	6049612	pump shroud conversion KS37-KS37Z KIT	1
Note: Ersatz / replacement / remplacement			
2	6016511	handle 54.1649/1 A2	1
8		motor casing 50.1704 Al	1
8		No longer available	1
9	6078160	o-ring ID.62,0x3,0 Viton (3pc)	1
10		nut M10 DIN934 A4-80	6
11		screw M10x120 A2	2
12		lock washer 10 DIN7980 A4 (10pc)	1
13	6001675	motor cover 52.1695 GG KIT	1
13.1		> motor cover D.126g6 52.1695 GG	1
13.2		> screw M8x20 ISO4762 A2-70	5
13.3		> o-ring ID.122,0x3,0 Viton	1
		alternativ / alternative / alternative	
13.1	6013978	motor cover D.126g6 52.1695 GG/C0	1

CONTRACTOR'S PUMP KS37H UNIT (6000098)

Item	Article no.	Description	Quantity
		Für Einschaltung Direkt	
		For direct-on-line starting	
		Pour démarrage direct	
14	6001886	cable gland 54.5696 GG KIT	1
14.1		> cable gland 54.5696 GG	1
14.2		> seal ring-profile 1646 Gi	1
14.3		> pressure ring 20,5 16 0,8 PG16 DIN46320	1
14.4		> o-ring ID.13,0x3,5 Viton	1
14.5	6003826	> cable protection 140x45 mm NR50° Shore	1
14.6		> screw M8x20 ISO4762 A2-70	2
15	6007632	cable NSSHÖU-J 4x1,5 round	
16	6001670	terminal board Melaminharz KIT	1
16.1		> terminal board Melaminharz	1
16.2		> duct bolt SW13x50 Ms	3
16.3		> pressure ring MS raw	3
16.4		> o-ring ID.5,0x2,0 NBR70	3
16.5		> washer A5,3 DIN125 A4	6
16.6		> lock washer 5 DIN7980 A4	9
16.7		> nut M5 DIN934 Ms	9
		Für Einschaltung Stern/Dreieck	
		For starting star-delta	
		Pour démarrage étoile-triangle	
14	6018980	cable gland 54. 5696 GG KIT	1
14.1		> cable gland 54.5696 GG	1
14.2		> seal ring-profile 5612 CR	1
14.3		> pressure ring 20,5 16 0,8 PG16 DIN46320	1
14.4		> o-ring ID.16,0x4,5 Viton	1
14.5	6003826	> cable protection 140x45 mm NR50° Shore	1
14.6		> screw M8x20 ISO4762 A2-70	2
15	6007534	cable NSSHÖU-J 7x1,5 round	
16	6024844	terminal board 53.11698 KIT	1
16.1		> terminal board Melaminharz	1
16.2		> duct bolt SW13x50 Ms	6
16.3		> pressure ring MS raw	6

CONTRACTOR'S PUMP KS37H UNIT (6000098)

Item	Article no.	Description	Quantity
16.4		> o-ring ID.5,0x2,0 NBR70	6
16.5		> washer A5,3 DIN125 A4	12
16.6		> lock washer 5 DIN7980 A4	18
16.7		> nut M5 DIN934 Ms	18

17		o-ring ID.65,0x3,0 Viton	1
18		screw M6x20 ISO4017 A2-70	3
19		screw M6x25 DIN939 A2-70	1
20		nut M6 DIN934 A4-80	2
21		lock washer 6 DIN7980 A4	1
22		washer A6,4 DIN125 A4	2
23		washer A6,4 DIN125 A4	3
24	6023486	stator F17-2/8 400/690 50Hz	1
		alternativ / alternative / alternative	
24	6023505	stator F17-2/8 230/400 50Hz	1
24	6023508	stator F17-2/8 500 50Hz VN01	1
25	6004661	circlips 174x2 54.1637 FSt	1
26	6035802	safety bar D.5x75 54.19444 St	1
27	6009995	rotor D.89x306 2/8 1.4021	1
29	6078164	ball bearing 6206 DDU C3 VP.	1
30	501355698	CIRCLIP 30X1,5 DIN471 FST	1
31	6001374	bearing housing U 51.1699 Al KIT	1
31.1		> bearing housing U 51.1699 Al	1
31.2	6067638	> screw plug G1/2 DIN908 A4 (3pcs)	1
31.3	6048832	> joint ring A21/26x1,5 DIN7603 PA(10pc)	1
31.4	6076642	> o-ring ID.203,0x3,0 Viton (3pc)	1
		alternativ / alternative / alternative	
31.1	6013940	bearing housing U 51.1699 Al/C0	1
31.1	6019019	bearing housing U 51.1699 Al/C1	1
32	6008974	ball bearing 6306	1
30	501355698	CIRCLIP 30X1,5 DIN471 FST	1
33	6009373	pressure ring D.72/39,2x19,1 55.1689 GG	1
34		o-ring ID.65,0x3,0 Viton	1
35	6077844	mech.seal MG1/30-G60-E1AQ1PGG VP.	1

CONTRACTOR'S PUMP KS37H UNIT (6000098)

Item	Article no.	Description	Quantity
		alternativ / alternative / alternative	
35	6074586	GRD. MG1/30-G4 Q1Q1VGG VP.	1
30	501355698	CIRCLIP 30X1,5 DIN471 FST	1
36	6074586	GRD. MG1/30-G4 Q1Q1VGG VP.	1
37	6002123	washer D.44/20x1 1.4301 -	1
38	6001372	sealing casing 52.1698/1 Al KIT	1
38.1		> sealing casing D.205g6 52.1698/1 Al	1
38.2	6076642	> o-ring ID.203,0x3,0 Viton (3pc)	1
		alternativ / alternative / alternative	
38.1	6013727	sealing casing D.205 52.1698/1 Al/C0	1
39	6075378	wear plate 53.1693 Neoprene VP.	1
		Laufrad / Impeller / Roue 50Hz	
40	6014072	impeller-M D.175 53.1223 GGG	1
		alternativ / alternative / alternative	
40	6021697	impeller-M D.175 53.1223 GGG/C0	1
40	6014071	impeller-M D.175 53.1223 Gbz	1
		Laufrad / Impeller / Roue 60Hz	
40	6014073	impeller-M D.155 54.1129 GGG	1
		alternativ / alternative / alternative	
40	6021696	impeller-M D.155 54.1129 GGG/C0	1
41	6043597	impeller fixation 55.5399/1 1.4021 KIT	1
41.1		> washer D.26/9x13 55.5399/1	1
41.2	6003416	> screw M8x25 DIN912 10.9 Geomet	1
41.3	6002688	> screw locking Nord-Lock 13,5/8,7 A4	1
41.4	6004654	> key A 6x4x18 54.2589 A4	1
44	6001370	pump housing A 51.1702 GG KIT	1
44.1		> pump housing A 51.1702 GG	1
44.2		> o-ring ID.270,0x3,0 Viton	1
44.1.1	6073152	neck ring D.105x13 6051846 1.4470 VP.	1
		alternativ / alternative / alternative	
44.1	6012861	pump housing A 51.1702 GG/C0	1
44.1	6012830	pump housing A 51.1702 GG/C1C1	1
44.1	6012845	pump housing A 51.1702 GG/C2C1	1
44.1	6012909	pump housing A 51.16785 1.4581	1

CONTRACTOR'S PUMP KS37H UNIT (6000098)

Item	Article no.	Description	Quantity
44.1	6022771	pump housing A 51.19190 Abrasit	1
44.1	6022779	pump housing A 53.19190 Abrasit/CO	1
45	6001371	strainer 53.17962 1.4301 KIT	1
45.1		> strainer 57x273x2 53.17962 1.4301	1
45.2		> base plate D.284 52.17961 Al	1
45.3		> screw M10x35 DIN933 A2-70	4
		alternativ / alternative / alternative	
45.1	6013069	strainer 57x273x2 53.17962 1.4301/CO	1
		Dubo-washer M10 NR.205 PA	1

<p>1 MCP 6A-M-H-20μF ~ 230V</p> <p>$I_N(230V / 50Hz) < 6A = 20\mu F$</p>	<p>2 MCP 10A-M-H-30μF ~ 230V</p> <p>$I_N(230V / 50Hz) 6-10A = 30\mu F$</p>	<p>3 MCP 6A-M-HA-20μF ~ 230V</p> <p>$I_N(230V / 50Hz) < 6A = 20\mu F$</p>	<p>4 MCP 10A-M-HA-30μF ~ 230V</p> <p>$I_N(230V / 50Hz) 6-10A = 30\mu F$</p>
<p>5 CEE16A</p>	<p>6 CEEM16W</p>	<p>7 CEEM16WD</p>	<p>8 MCP T4-HA-ROT-WSK CEE16-5PS</p>
<p>9 CEE32A</p>	<p>10 MCP 10-16A-T4-H-ROT CEE32-5PS</p> <p>CEEM32WD</p>	<p>11 CEEM32WDSHA</p>	<p>12 CEE63A</p>

PLUG

Item	Article no.	Description	Quantity
		IN (230V / 50Hz) <6A - 20µF	
1	6072332	MCP 6A-M-H-20µF-CEE7/7 VP.	1
1.1	6071702	capacitor 400V 20µF MCP VP.	1
1.2	6071704	protection switch 6A MCP VP.	1
1.3	6071707	protecting cap MCP VP.	1
		IN (230V / 50Hz) 6-10A - 30µF	
2	6072330	MCP 10A-M-H-30µF-CEE7/7 VP.	1
2.1	6071703	capacitor 400V 30µF MCP VP.	1
2.2	6071705	protection switch 10A MCP VP.	1
2.3	6071707	protecting cap MCP VP.	1
		IN (230V / 50Hz) <6A - 20µF	
3	6072331	MCP 6A-M-HA-20µF-CEE7/7 VP.	1
3.1	6071702	capacitor 400V 20µF MCP VP.	1
3.2	6071704	protection switch 6A MCP VP.	1
3.3	6071707	protecting cap MCP VP.	2
3.4	6071706	switch on/out MCP VP.	1
		IN (230V / 50Hz) 6-10A - 30µF	
4	6072329	MCP 10A-M-HA-30µF-CEE7/7 VP	1
4.1	6071703	capacitor 400V 30µF MCP VP.	1
4.2	6071705	protection switch 10A MCP VP.	1
4.3	6071707	protecting cap MCP VP.	2
4.4	6071706	switch on/out MCP VP.	1
5	6003000	plug CEE16A/400V 60Hz/5P-11h	1
5	6003248	plug CEE16A/400V/4P-6H	1
5	6003009	plug CEE16A/400V/5P-6H	1
5	6039156	plug CEE16A/400V/5P-6H Phase inverter	1
5	6035231	plug CEE16A/400V/7P-6H	1
5	6003011	plug CEE16A/500V/5P-7H	1
6	6030883	plug MS400V5P CEE16A W 1,0-1,6A	1
6	6030884	plug MS400V5P CEE16A W 1,6-2,5A	1
6	6030888	plug MS400V5P CEE16A W 10,0-16,0A	1
6	6030885	plug MS400V5P CEE16A W 2,5-4,0A	1
6	6030886	plug MS400V5P CEE16A W 4,0-6,3A	1
6	6030887	plug MS400V5P CEE16A W 6,3-10,0A	1

PLUG

Item	Article no.	Description	Quantity
7	6032446	plug MS400V4P CEE16A WD 1,6-2,5A	1
7	6032447	plug MS400V4P CEE16A WD 12,5-16,0A	1
7	6032295	plug MS400V4P CEE16A WD 2,5-4,0A	1
7	6032289	plug MS400V4P CEE16A WD 4,0-6,3A	1
7	6032292	plug MS400V4P CEE16A WD 6,3-9,0A	1
7	6042190	plug MS400V5P CEE16A WDII 1,6-2,5A	1
7	6042194	plug MS400V5P CEE16A WDII 10,0-16,0A	1
7	6042191	plug MS400V5P CEE16A WDII 2,5-4,0A	1
7	6042192	plug MS400V5P CEE16A WDII 4,0-6,3A	1
7	6042193	plug MS400V5P CEE16A WDII 6,3-10,0A	1
7	6035911	plug MS400V5P CEE16A WD 9,0-12,5A	1
7	6003337	plug MS500V5P CEE16A WD 1,6-2,5A	1
7	6003336	plug MS500V5P CEE16A WD 2,5-4,0A	1
7	6003335	plug MS500V5P CEE16A WD 4,0-6,3A	1
7	6003334	plug MS500V5P CEE16A WD 6,3-9,0A	1
8	6072520	MCP 1,0-1,6A-T4-HA-ROT-WSK-CEE16-5PS VP.	1
8	6072521	MCP 1,6-2,4A-T4-HA-ROT-WSK-CEE16-5PS VP.	1
8	6072522	MCP 2,4-4,0A-T4-HA-ROT-WSK-CEE16-5PS VP.	1
8	6072523	MCP 4,0-6,0A-T4-HA-ROT-WSK-CEE16-5PS VP.	1
8	6072524	MCP 6,0-10A-T4-HA-ROT-WSK-CEE16-5PS VP.	1
8	6072525	MCP 9,0-12A-T4-HA-ROT-WSK-CEE16-5PS VP.	1
8	6072526	MCP 12-16A-T4-HA-ROT-WSK-CEE16-5PS VP.	1
9	6003267	plug CEE32A/400V/4P-6H	1
9	6039155	plug CEE32A/400V/5P-6H Phase inverter	1
9	6035895	plug CEE32A/500V/4P-7H AM-Top	1
9	6003010	plug CEE32A/500V/5P-7H	1
10	6072370	MCP 400V 1,6-2,5A-T4-H-ROT-CEE32-5PS VP.	1
10	6072369	MCP 400V 2,5-4,0A-T4-H-ROT-CEE32-5PS VP.	1
10	6072371	MCP 400V 4,0-6,3A-T4-H-ROT-CEE32-5PS VP.	1
10	6072398	MCP 400V 6,3-10A-T4-H-ROT-CEE32-5PS VP.	1
10	6072519	MCP 400V 10-16A-T4-H-ROT-CEE32-5PS VP.	1
10	6072399	MCP 400V 16-20A-T4-H-ROT-CEE32-5PS VP.	1
10	6072518	MCP 400V 20-25A-T4-H-ROT-CEE32-5PS VP.	1
10	6037649	plug.MS500V4P CEE32A WD 2,5-4,0A	1

PLUG

Item	Article no.	Description	Quantity
10	6041268	plug MS500V4P CEE32A WD 4,0-6,3A	1
10	6035244	plug MS500V5P CEE32A WD 1,6-2,5A	1
10	6034700	plug MS500V5P CEE32A WD 2,5-4,0A	1
10	6041556	plug MS500V5P CEE32A WD 4,0-6,3A	1
10	6002701	plug MS500V5P CEE32A WD 9,0-12,5A	1
10	6002700	plug MS500V5P CEE32A WD 12,5-16,0A	1
11	6003241	plug MS400V5P CEE32A WDSHA 10,0-14,0A	1
11	6003266	plug MS400V5P CEE32A WDSHA 3,7-5,5A	1
11	6003265	plug MS400V5P CEE32A WDSHA 5,5-8,0A	1
11	6003264	plug MS400V5P CEE32A WDSHA 8,0-11,5A	1
12	6003012	plug CEE63A/400V/5P-6H/IP67	1

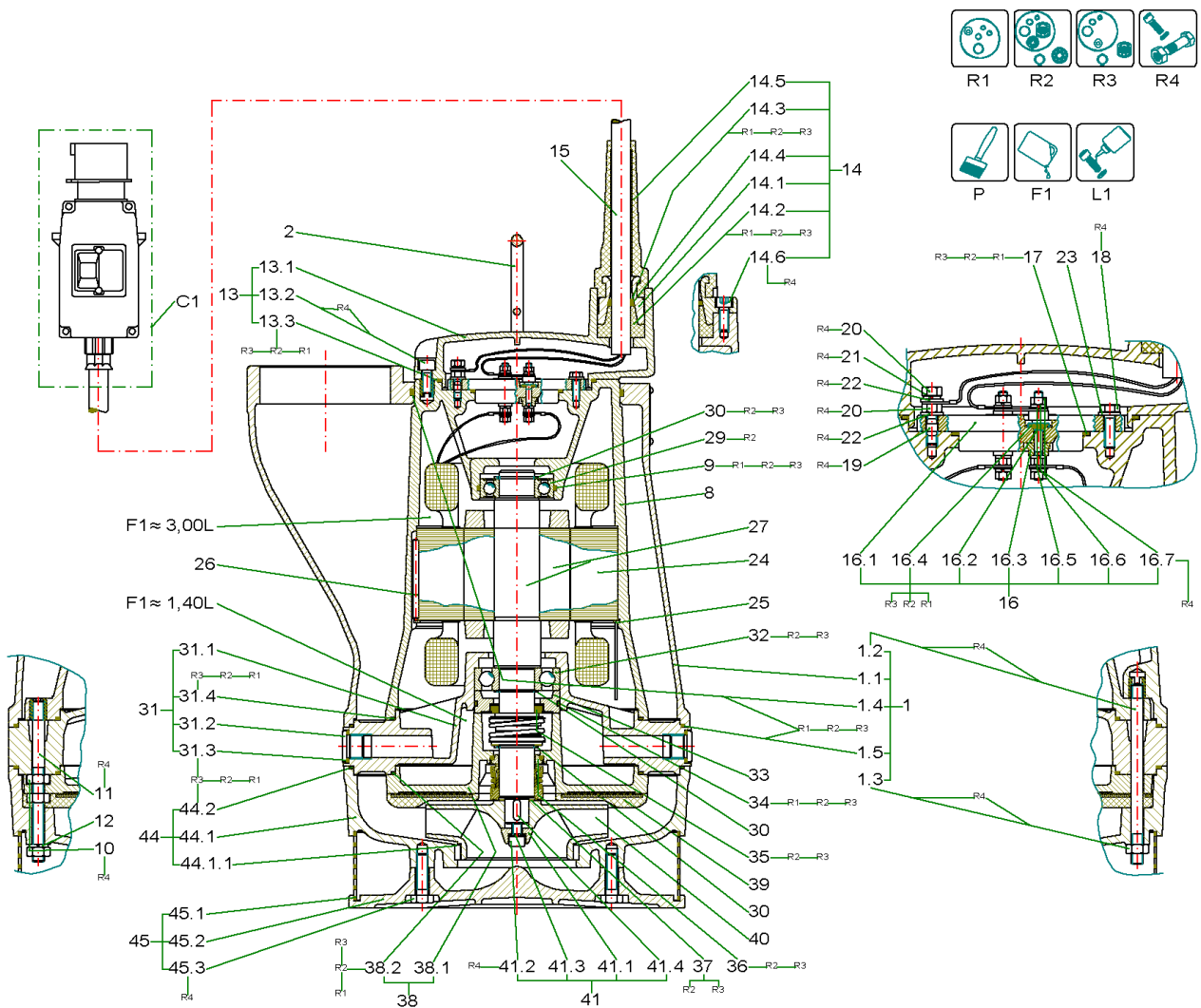

CONTRACTOR'S PUMP KS37M UNIT (6000099)

Item	Article no.	Description	Quantity
R1	6016259	Rep.Kit 1 KS37,70+Z Vit	1
R2	6016303	Rep.Kit 2 KS37,70 +Z Vit	1
R3	6016304	Rep.Kit 3 KS37,70+Z Vit	1
R4	6016128	Screws KS37,70 + Z KIT	1
P	6042254	PAINT SPRAY Pantone334	1
P	6042255	colour 2K-paint IV80 pantone334C 250ml	1
P	6023614	Ceram C0 black 100 ml KIT	1
P	6020579	Ceram C0 black 250 ml KIT	1
P	6023485	Ceram C0 Black 500ml Kit	1
P	6019157	Ceram C0 black 1000 ml KIT	1
F1	6025461	medical white oil 5L KIT	1
F1	6025460	medical white oil 1L KIT	1
L1	6080531	Loctite 243 5g flask VP:	1
L1	2096167	Loctite 243 50ml VP.	1

C1		PLUG	1

1		pump shroud SG4 1694 Al KIT	1
Note: nicht mehr lieferbar / no longer available / ne plus disponible			
1	6049612	pump shroud conversion KS37-KS37Z KIT	1
Note: Ersatz / replacement / remplacement			
2	6016511	handle 54.1649/1 A2	1
8		motor casing 50.1704 Al	1
8		No longer available	1
9	6078160	o-ring ID.62,0x3,0 Viton (3pc)	1
10		nut M10 DIN934 A4-80	6
11		screw M10x120 A2	2
12		lock washer 10 DIN7980 A4 (10pc)	1
13	6001675	motor cover 52.1695 GG KIT	1
13.1		> motor cover D.126g6 52.1695 GG	1
13.2		> screw M8x20 ISO4762 A2-70	5
13.3		> o-ring ID.122,0x3,0 Viton	1
		alternativ / alternative / alternative	
13.1	6013978	motor cover D.126g6 52.1695 GG/C0	1

CONTRACTOR'S PUMP KS37M UNIT (6000099)

Item	Article no.	Description	Quantity
		Für Einschaltung Direkt	
		For direct-on-line starting	
		Pour démarrage direct	
14	6001886	cable gland 54.5696 GG KIT	1
14.1		> cable gland 54.5696 GG	1
14.2		> seal ring-profile 1646 Gi	1
14.3		> pressure ring 20,5 16 0,8 PG16 DIN46320	1
14.4		> o-ring ID.13,0x3,5 Viton	1
14.5	6003826	> cable protection 140x45 mm NR50° Shore	1
14.6		> screw M8x20 ISO4762 A2-70	2
15	6007632	cable NSSHÖU-J 4x1,5 round	
16	6001670	terminal board Melaminharz KIT	1
16.1		> terminal board Melaminharz	1
16.2		> duct bolt SW13x50 Ms	3
16.3		> pressure ring MS raw	3
16.4		> o-ring ID.5,0x2,0 NBR70	3
16.5		> washer A5,3 DIN125 A4	6
16.6		> lock washer 5 DIN7980 A4	9
16.7		> nut M5 DIN934 Ms	9
		Für Einschaltung Stern/Dreieck	
		For starting star-delta	
		Pour démarrage étoile-triangle	
14	6018980	cable gland 54. 5696 GG KIT	1
14.1		> cable gland 54.5696 GG	1
14.2		> seal ring-profile 5612 CR	1
14.3		> pressure ring 20,5 16 0,8 PG16 DIN46320	1
14.4		> o-ring ID.16,0x4,5 Viton	1
14.5	6003826	> cable protection 140x45 mm NR50° Shore	1
14.6		> screw M8x20 ISO4762 A2-70	2
15	6007534	cable NSSHÖU-J 7x1,5 round	
16	6024844	terminal board 53.11698 KIT	1
16.1		> terminal board Melaminharz	1
16.2		> duct bolt SW13x50 Ms	6
16.3		> pressure ring MS raw	6

CONTRACTOR'S PUMP KS37M UNIT (6000099)

Item	Article no.	Description	Quantity
16.4		> o-ring ID.5,0x2,0 NBR70	6
16.5		> washer A5,3 DIN125 A4	12
16.6		> lock washer 5 DIN7980 A4	18
16.7		> nut M5 DIN934 Ms	18

17		o-ring ID.65,0x3,0 Viton	1
18		screw M6x20 ISO4017 A2-70	3
19		screw M6x25 DIN939 A2-70	1
Note: nur in Verwendung mit dem Pumpengehäuse / only for use with pump casing / seulement pour l`emploi avec le corps de pompe en 6023613			
20		nut M6 DIN934 A4-80	2
Note: nur in Verwendung mit dem Wirbelstromlaufrad / only for use with vortex impeller / seulement pour l`emploi avec la roue vortex 6023612			
21		lock washer 6 DIN7980 A4	1
22		washer A6,4 DIN125 A4	2
23		washer A6,4 DIN125 A4	3
24	6023486	stator F17-2/8 400/690 50Hz	1
		alternativ / alternative / alternative	
24	6023505	stator F17-2/8 230/400 50Hz	1
24	6023508	stator F17-2/8 500 50Hz VN01	1
25	6004661	circlips 174x2 54.1637 FSt	1
26	6035802	safety bar D.5x75 54.19444 St	1
27	6009995	rotor D.89x306 2/8 1.4021	1
29	6078164	ball bearing 6206 DDU C3 VP.	1
30	501355698	CIRCLIP 30X1,5 DIN471 FST	1
31	6001374	bearing housing U 51.1699 Al KIT	1
31.1		> bearing housing U 51.1699 Al	1
31.2	6067638	> screw plug G1/2 DIN908 A4 (3pcs)	1
31.3	6048832	> joint ring A21/26x1,5 DIN7603 PA(10pc)	1
31.4	6076642	> o-ring ID.203,0x3,0 Viton (3pc)	1
		alternativ / alternative / alternative	
31.1	6013940	bearing housing U 51.1699 Al/C0	1
31.1	6019019	bearing housing U 51.1699 Al/C1	1
32	6008974	ball bearing 6306	1
30	501355698	CIRCLIP 30X1,5 DIN471 FST	1

CONTRACTOR'S PUMP KS37M UNIT (6000099)

Item	Article no.	Description	Quantity
33	6009373	pressure ring D.72/39,2x19,1 55.1689 GG	1
34		o-ring ID.65,0x3,0 Viton	1
35	6077844	mech.seal MG1/30-G60-E1AQ1PGG VP. alternativ / alternative / alternative	1
35	6074586	GRD. MG1/30-G4 Q1Q1VGG VP.	1
30	501355698	CIRCLIP 30X1,5 DIN471 FST	1
36	6074586	GRD. MG1/30-G4 Q1Q1VGG VP.	1
37	6002123	washer D.44/20x1 1.4301 -	1
38	6001372	sealing casing 52.1698/1 Al KIT	1
38.1		> sealing casing D.205g6 52.1698/1 Al	1
38.2	6076642	> o-ring ID.203,0x3,0 Viton (3pc) alternativ / alternative / alternative	1
38.1	6013727	sealing casing D.205 52.1698/1 Al/CO	1
39	6075378	wear plate 53.1693 Neoprene VP. Laufrad / Impeller / Roue 50Hz	1
40	6014033	impeller-M D.148 53.3554/1 GGG alternativ / alternative / alternative	1
40	6001403	impeller-M D.148 53.3554/1 GGG/CO	1
40	6014157	impeller-M D.148 53.17063 Abrasit	1
40	6024255	impeller-M D.148 53.17063 Abrasit/CO	1
40	6014021	impeller-M D.148 53.3554/1 1.4581 Laufrad / Impeller / Roue 60Hz	1
40	6014020	impeller-M D.135 53.3554/2 GGG alternativ / alternative / alternative	1
40	6021744	impeller-M D.135 53.3554/2 GGG/CO	1
40	6022774	impeller-M D.135 53.19185 Abrasit	1
40	6024257	impeller-M D.135 53.19185 Abrasit/CO	1
40	6021651	impeller-M D.135 53.3554/2 1.4581	1
41	6043597	impeller fixation 55.5399/1 1.4021 KIT	1
41.1		> washer D.26/9x13 55.5399/1	1
41.2	6003416	> screw M8x25 DIN912 10.9 Geomet	1
41.3	6002688	> screw locking Nord-Lock 13,5/8,7 A4	1
41.4	6004654	> key A 6x4x18 54.2589 A4	1
44	6001370	pump housing A 51.1702 GG KIT	1

CONTRACTOR'S PUMP KS37M UNIT (6000099)

Item	Article no.	Description	Quantity
44.1		> pump housing A 51.1702 GG	1
44.2		> o-ring ID.270,0x3,0 Viton	1
44.1.1	6073152	neck ring D.105x13 6051846 1.4470 VP. alternativ / alternative / alternative	1
44.1	6012861	pump housing A 51.1702 GG/C0	1
44.1	6012830	pump housing A 51.1702 GG/C1C1	1
44.1	6012845	pump housing A 51.1702 GG/C2C1	1
44.1	6012909	pump housing A 51.16785 1.4581	1
44.1	6022771	pump housing A 51.19190 Abrasit	1
44.1	6022779	pump housing A 53.19190 Abrasit/C0	1
45	6001371	strainer 53.17962 1.4301 KIT	1
45.1		> strainer 57x273x2 53.17962 1.4301	1
45.2		> base plate D.284 52.17961 Al	1
45.3		> screw M10x35 DIN933 A2-70 alternativ / alternative / alternative	4
45.1	6013069	strainer 57x273x2 53.17962 1.4301/CO -----	1
		No longer available	1
		Sonderausführung Freistromhydraulik / special design: vortex hydraulic / exécu. spéciale: hydraulic vortex	
40		impeller-W KS 37 1.4825	1
Note: nur in Verwendung mit dem Pumpengehäuse/ only for use with pump casing /			
44.1		pump housing A KS 37 1.4825	1
Note: nur in Verwendung mit dem Wirbelstromlaufrad / only for use with -----			
		Dubo-washer M10 NR.205 PA	4

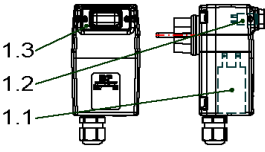
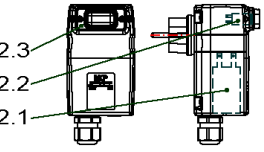
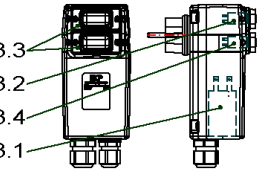
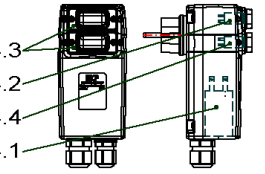
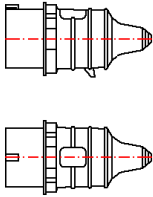
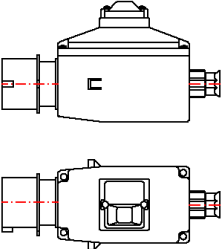
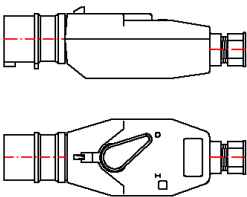
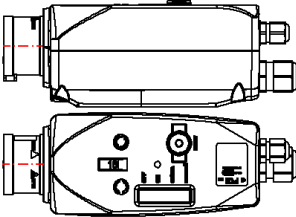
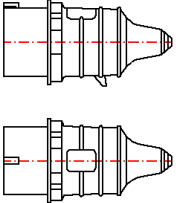
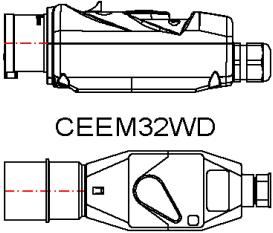
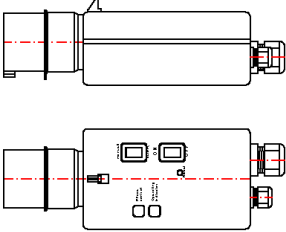
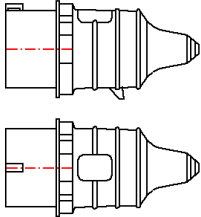
<p>1 MCP 6A-M-H-20μF ~ 230V</p>  <p>$I_N(230V / 50Hz) < 6A = 20\mu F$</p>	<p>2 MCP 10A-M-H-30μF ~ 230V</p>  <p>$I_N(230V / 50Hz) 6-10A = 30\mu F$</p>	<p>3 MCP 6A-M-HA-20μF ~ 230V</p>  <p>$I_N(230V / 50Hz) < 6A = 20\mu F$</p>	<p>4 MCP 10A-M-HA-30μF ~ 230V</p>  <p>$I_N(230V / 50Hz) 6-10A = 30\mu F$</p>
<p>5 CEE16A</p> 	<p>6 CEEM16W</p> 	<p>7 CEEM16WD</p> 	<p>8 MCP T4-HA-ROT-WSK CEE16-5PS</p> 
<p>9 CEE32A</p> 	<p>10 MCP 10-16A-T4-H-ROT CEE32-5PS</p>  <p>CEEM32WD</p>	<p>11 CEEM32WDSHA</p> 	<p>12 CEE63A</p> 

PLUG

Item	Article no.	Description	Quantity
		IN (230V / 50Hz) <6A - 20μF	
1	6072332	MCP 6A-M-H-20μF-CEE7/7 VP.	1
1.1	6071702	capacitor 400V 20μF MCP VP.	1
1.2	6071704	protection switch 6A MCP VP.	1
1.3	6071707	protecting cap MCP VP.	1
		IN (230V / 50Hz) 6-10A - 30μF	
2	6072330	MCP 10A-M-H-30μF-CEE7/7 VP.	1
2.1	6071703	capacitor 400V 30μF MCP VP.	1
2.2	6071705	protection switch 10A MCP VP.	1
2.3	6071707	protecting cap MCP VP.	1
		IN (230V / 50Hz) <6A - 20μF	
3	6072331	MCP 6A-M-HA-20μF-CEE7/7 VP.	1
3.1	6071702	capacitor 400V 20μF MCP VP.	1
3.2	6071704	protection switch 6A MCP VP.	1
3.3	6071707	protecting cap MCP VP.	2
3.4	6071706	switch on/out MCP VP.	1
		IN (230V / 50Hz) 6-10A - 30μF	
4	6072329	MCP 10A-M-HA-30μF-CEE7/7 VP	1
4.1	6071703	capacitor 400V 30μF MCP VP.	1
4.2	6071705	protection switch 10A MCP VP.	1
4.3	6071707	protecting cap MCP VP.	2
4.4	6071706	switch on/out MCP VP.	1
5	6003000	plug CEE16A/400V 60Hz/5P-11h	1
5	6003248	plug CEE16A/400V/4P-6H	1
5	6003009	plug CEE16A/400V/5P-6H	1
5	6039156	plug CEE16A/400V/5P-6H Phase inverter	1
5	6035231	plug CEE16A/400V/7P-6H	1
5	6003011	plug CEE16A/500V/5P-7H	1
6	6030883	plug MS400V5P CEE16A W 1,0-1,6A	1
6	6030884	plug MS400V5P CEE16A W 1,6-2,5A	1
6	6030888	plug MS400V5P CEE16A W 10,0-16,0A	1
6	6030885	plug MS400V5P CEE16A W 2,5-4,0A	1
6	6030886	plug MS400V5P CEE16A W 4,0-6,3A	1
6	6030887	plug MS400V5P CEE16A W 6,3-10,0A	1

PLUG

Item	Article no.	Description	Quantity
7	6032446	plug MS400V4P CEE16A WD 1,6-2,5A	1
7	6032447	plug MS400V4P CEE16A WD 12,5-16,0A	1
7	6032295	plug MS400V4P CEE16A WD 2,5-4,0A	1
7	6032289	plug MS400V4P CEE16A WD 4,0-6,3A	1
7	6032292	plug MS400V4P CEE16A WD 6,3-9,0A	1
7	6042190	plug MS400V5P CEE16A WDII 1,6-2,5A	1
7	6042194	plug MS400V5P CEE16A WDII 10,0-16,0A	1
7	6042191	plug MS400V5P CEE16A WDII 2,5-4,0A	1
7	6042192	plug MS400V5P CEE16A WDII 4,0-6,3A	1
7	6042193	plug MS400V5P CEE16A WDII 6,3-10,0A	1
7	6035911	plug MS400V5P CEE16A WD 9,0-12,5A	1
7	6003337	plug MS500V5P CEE16A WD 1,6-2,5A	1
7	6003336	plug MS500V5P CEE16A WD 2,5-4,0A	1
7	6003335	plug MS500V5P CEE16A WD 4,0-6,3A	1
7	6003334	plug MS500V5P CEE16A WD 6,3-9,0A	1
8	6072520	MCP 1,0-1,6A-T4-HA-ROT-WSK-CEE16-5PS VP.	1
8	6072521	MCP 1,6-2,4A-T4-HA-ROT-WSK-CEE16-5PS VP.	1
8	6072522	MCP 2,4-4,0A-T4-HA-ROT-WSK-CEE16-5PS VP.	1
8	6072523	MCP 4,0-6,0A-T4-HA-ROT-WSK-CEE16-5PS VP.	1
8	6072524	MCP 6,0-10A-T4-HA-ROT-WSK-CEE16-5PS VP.	1
8	6072525	MCP 9,0-12A-T4-HA-ROT-WSK-CEE16-5PS VP.	1
8	6072526	MCP 12-16A-T4-HA-ROT-WSK-CEE16-5PS VP.	1
9	6003267	plug CEE32A/400V/4P-6H	1
9	6039155	plug CEE32A/400V/5P-6H Phase inverter	1
9	6035895	plug CEE32A/500V/4P-7H AM-Top	1
9	6003010	plug CEE32A/500V/5P-7H	1
10	6072370	MCP 400V 1,6-2,5A-T4-H-ROT-CEE32-5PS VP.	1
10	6072369	MCP 400V 2,5-4,0A-T4-H-ROT-CEE32-5PS VP.	1
10	6072371	MCP 400V 4,0-6,3A-T4-H-ROT-CEE32-5PS VP.	1
10	6072398	MCP 400V 6,3-10A-T4-H-ROT-CEE32-5PS VP.	1
10	6072519	MCP 400V 10-16A-T4-H-ROT-CEE32-5PS VP.	1
10	6072399	MCP 400V 16-20A-T4-H-ROT-CEE32-5PS VP.	1
10	6072518	MCP 400V 20-25A-T4-H-ROT-CEE32-5PS VP.	1
10	6037649	plug.MS500V4P CEE32A WD 2,5-4,0A	1

PLUG

Item	Article no.	Description	Quantity
10	6041268	plug MS500V4P CEE32A WD 4,0-6,3A	1
10	6035244	plug MS500V5P CEE32A WD 1,6-2,5A	1
10	6034700	plug MS500V5P CEE32A WD 2,5-4,0A	1
10	6041556	plug MS500V5P CEE32A WD 4,0-6,3A	1
10	6002701	plug MS500V5P CEE32A WD 9,0-12,5A	1
10	6002700	plug MS500V5P CEE32A WD 12,5-16,0A	1
11	6003241	plug MS400V5P CEE32A WDSHA 10,0-14,0A	1
11	6003266	plug MS400V5P CEE32A WDSHA 3,7-5,5A	1
11	6003265	plug MS400V5P CEE32A WDSHA 5,5-8,0A	1
11	6003264	plug MS400V5P CEE32A WDSHA 8,0-11,5A	1
12	6003012	plug CEE63A/400V/5P-6H/IP67	1

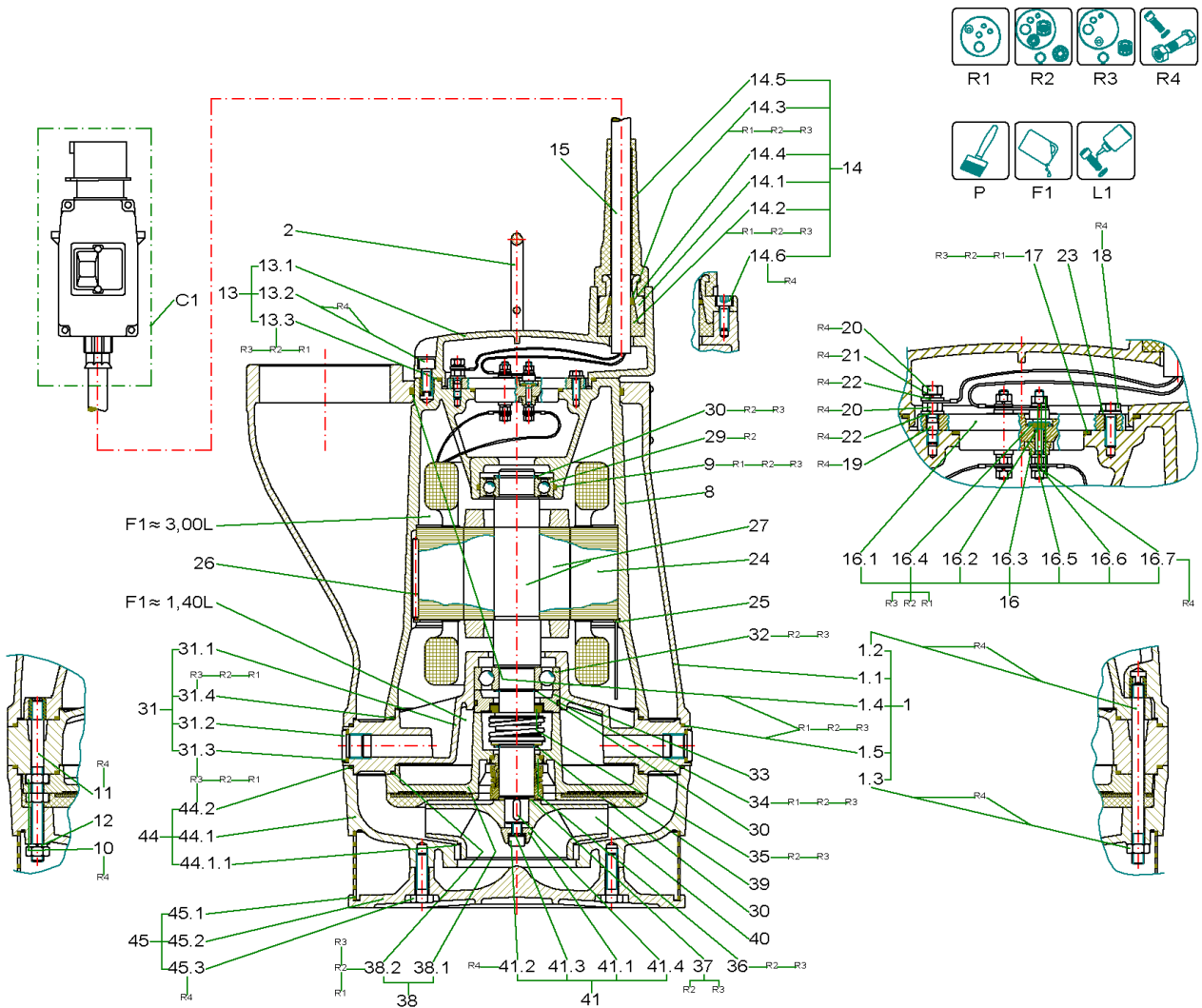

CONTRACTOR'S PUMP KS37N UNIT (6000100)

Item	Article no.	Description	Quantity
R1	6016259	Rep.Kit 1 KS37,70+Z Vit	1
R2	6016303	Rep.Kit 2 KS37,70 +Z Vit	1
R3	6016304	Rep.Kit 3 KS37,70+Z Vit	1
R4	6016128	Screws KS37,70 + Z KIT	1
P	6042254	PAINT SPRAY Pantone334	1
P	6042255	colour 2K-paint IV80 pantone334C 250ml	1
P	6023614	Ceram C0 black 100 ml KIT	1
P	6020579	Ceram C0 black 250 ml KIT	1
P	6023485	Ceram C0 Black 500ml Kit	1
P	6019157	Ceram C0 black 1000 ml KIT	1
F1	6025461	medical white oil 5L KIT	1
F1	6025460	medical white oil 1L KIT	1
L1	6080531	Loctite 243 5g flask VP:	1
L1	2096167	Loctite 243 50ml VP.	1

C1		PLUG	1

1		pump shroud SG4 1694 Al KIT	1
Note: nicht mehr lieferbar / no longer available / ne plus disponible			
1	6049612	pump shroud conversion KS37-KS37Z KIT	1
Note: Ersatz / replacement / remplacement			
2	6016511	handle 54.1649/1 A2	1
8		motor casing 50.1704 Al	1
8		No longer available	1
9	6078160	o-ring ID.62,0x3,0 Viton (3pc)	1
10		nut M10 DIN934 A4-80	6
11		screw M10x120 A2	2
12		lock washer 10 DIN7980 A4 (10pc)	1
13	6001675	motor cover 52.1695 GG KIT	1
13.1		> motor cover D.126g6 52.1695 GG	1
13.2		> screw M8x20 ISO4762 A2-70	5
13.3		> o-ring ID.122,0x3,0 Viton	1
		alternativ / alternative / alternative	
13.1	6013978	motor cover D.126g6 52.1695 GG/C0	1

CONTRACTOR'S PUMP KS37N UNIT (6000100)

Item	Article no.	Description	Quantity
		Für Einschaltung Direkt	
		For direct-on-line starting	
		Pour démarrage direct	
14	6001886	cable gland 54.5696 GG KIT	1
14.1		> cable gland 54.5696 GG	1
14.2		> seal ring-profile 1646 Gi	1
14.3		> pressure ring 20,5 16 0,8 PG16 DIN46320	1
14.4		> o-ring ID.13,0x3,5 Viton	1
14.5	6003826	> cable protection 140x45 mm NR50° Shore	1
14.6		> screw M8x20 ISO4762 A2-70	2
15	6007632	cable NSSHÖU-J 4x1,5 round	
16	6001670	terminal board Melaminharz KIT	1
16.1		> terminal board Melaminharz	1
16.2		> duct bolt SW13x50 Ms	3
16.3		> pressure ring MS raw	3
16.4		> o-ring ID.5,0x2,0 NBR70	3
16.5		> washer A5,3 DIN125 A4	6
16.6		> lock washer 5 DIN7980 A4	9
16.7		> nut M5 DIN934 Ms	9
		Für Einschaltung Stern/Dreieck	
		For starting star-delta	
		Pour démarrage étoile-triangle	
14	6018980	cable gland 54. 5696 GG KIT	1
14.1		> cable gland 54.5696 GG	1
14.2		> seal ring-profile 5612 CR	1
14.3		> pressure ring 20,5 16 0,8 PG16 DIN46320	1
14.4		> o-ring ID.16,0x4,5 Viton	1
14.5	6003826	> cable protection 140x45 mm NR50° Shore	1
14.6		> screw M8x20 ISO4762 A2-70	2
15	6007534	cable NSSHÖU-J 7x1,5 round	
16	6024844	terminal board 53.11698 KIT	1
16.1		> terminal board Melaminharz	1
16.2		> duct bolt SW13x50 Ms	6
16.3		> pressure ring MS raw	6

CONTRACTOR'S PUMP KS37N UNIT (6000100)

Item	Article no.	Description	Quantity
16.4		> o-ring ID.5,0x2,0 NBR70	6
16.5		> washer A5,3 DIN125 A4	12
16.6		> lock washer 5 DIN7980 A4	18
16.7		> nut M5 DIN934 Ms	18

17		o-ring ID.65,0x3,0 Viton	1
18		screw M6x20 ISO4017 A2-70	3
19		screw M6x25 DIN939 A2-70	1
20		nut M6 DIN934 A4-80	2
21		lock washer 6 DIN7980 A4	1
22		washer A6,4 DIN125 A4	2
23		washer A6,4 DIN125 A4	3
24	6023486	stator F17-2/8 400/690 50Hz	1
		alternativ / alternative / alternative	
24	6023505	stator F17-2/8 230/400 50Hz	1
24	6023508	stator F17-2/8 500 50Hz VN01	1
25	6004661	circlips 174x2 54.1637 FSt	1
26	6035802	safety bar D.5x75 54.19444 St	1
27	6009995	rotor D.89x306 2/8 1.4021	1
29	6078164	ball bearing 6206 DDU C3 VP.	1
30	501355698	CIRCLIP 30X1,5 DIN471 FST	1
31	6001374	bearing housing U 51.1699 Al KIT	1
31.1		> bearing housing U 51.1699 Al	1
31.2	6067638	> screw plug G1/2 DIN908 A4 (3pcs)	1
31.3	6048832	> joint ring A21/26x1,5 DIN7603 PA(10pc)	1
31.4	6076642	> o-ring ID.203,0x3,0 Viton (3pc)	1
		alternativ / alternative / alternative	
31.1	6013940	bearing housing U 51.1699 Al/C0	1
31.1	6019019	bearing housing U 51.1699 Al/C1	1
32	6008974	ball bearing 6306	1
30	501355698	CIRCLIP 30X1,5 DIN471 FST	1
33	6009373	pressure ring D.72/39,2x19,1 55.1689 GG	1
34		o-ring ID.65,0x3,0 Viton	1
35	6077844	mech.seal MG1/30-G60-E1AQ1PGG VP.	1

CONTRACTOR'S PUMP KS37N UNIT (6000100)

Item	Article no.	Description	Quantity
		alternativ / alternative / alternative	
35	6074586	GRD. MG1/30-G4 Q1Q1VGG VP.	1
30	501355698	CIRCLIP 30X1,5 DIN471 FST	1
36	6074586	GRD. MG1/30-G4 Q1Q1VGG VP.	1
37	6002123	washer D.44/20x1 1.4301 -	1
38	6001372	sealing casing 52.1698/1 Al KIT	1
38.1		> sealing casing D.205g6 52.1698/1 Al	1
38.2	6076642	> o-ring ID.203,0x3,0 Viton (3pc)	1
		alternativ / alternative / alternative	
38.1	6013727	sealing casing D.205 52.1698/1 Al/CO	1
39	6075378	wear plate 53.1693 Neoprene VP.	1
		Laufrad / Impeller / Roue 50Hz	
40	6014043	impeller-M D.137 53.1029 GGG	1
		alternativ / alternative / alternative	
40	6021691	impeller-M D.137 53.1029 GGG/CO	1
40	6010631	impeller-M D.137 53.17903 Abrasit	1
40	6024254	impeller-M D.137 53.17903 Abrasit/CO	1
40	6021642	impeller-M D.137 53.1029 1.4581	1
		Laufrad / Impeller / Roue 60Hz	
40	6022872	impeller-M D.124 53.1029 GGG	1
		alternativ / alternative / alternative	
40	6022874	impeller-M D.124 53.1029 GGG/CO	1
40	6022773	impeller-M D.124 53.17903 Abrasit	1
40	6024256	impeller-M D.124 53.17903 Abrasit/CO	1
40	6022873	impeller-M D.124 53.1029 1.4581	1
41	6043597	impeller fixation 55.5399/1 1.4021 KIT	1
41.1		> washer D.26/9x13 55.5399/1	1
41.2	6003416	> screw M8x25 DIN912 10.9 Geomet	1
41.3	6002688	> screw locking Nord-Lock 13,5/8,7 A4	1
41.4	6004654	> key A 6x4x18 54.2589 A4	1
44	6001370	pump housing A 51.1702 GG KIT	1
44.1		> pump housing A 51.1702 GG	1
44.2		> o-ring ID.270,0x3,0 Viton	1
44.1.1	6073152	neck ring D.105x13 6051846 1.4470 VP.	1

CONTRACTOR'S PUMP KS37N UNIT (6000100)

Item	Article no.	Description	Quantity
		alternativ / alternative / alternative	
44.1	6012861	pump housing A 51.1702 GG/C0	1
44.1	6012830	pump housing A 51.1702 GG/C1C1	1
44.1	6012845	pump housing A 51.1702 GG/C2C1	1
44.1	6012909	pump housing A 51.16785 1.4581	1
44.1	6022771	pump housing A 51.19190 Abrasit	1
44.1	6022779	pump housing A 53.19190 Abrasit/C0	1
45	6001371	strainer 53.17962 1.4301 KIT	1
45.1		> strainer 57x273x2 53.17962 1.4301	1
45.2		> base plate D.284 52.17961 Al	1
45.3		> screw M10x35 DIN933 A2-70	4
		alternativ / alternative / alternative	
45.1	6013069	strainer 57x273x2 53.17962 1.4301/CO	1
		Dubo-washer M10 NR.205 PA	1

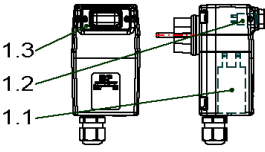
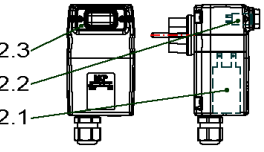
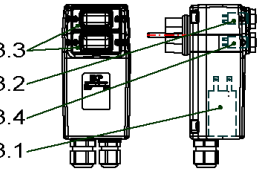
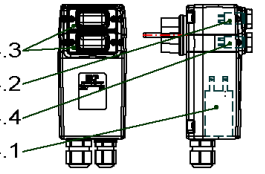
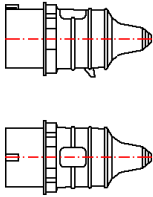
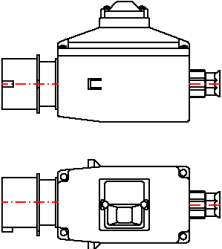
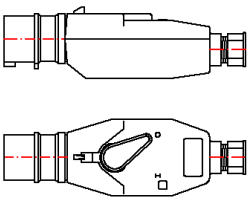
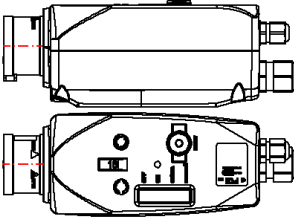
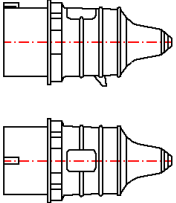
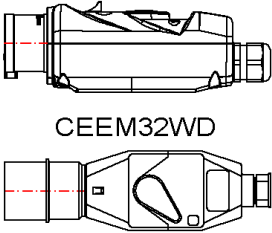
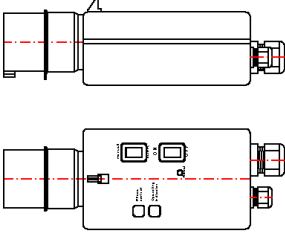
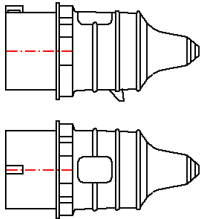
<p>1 MCP 6A-M-H-20μF ~ 230V</p>  <p>$I_N(230V / 50Hz) < 6A = 20\mu F$</p>	<p>2 MCP 10A-M-H-30μF ~ 230V</p>  <p>$I_N(230V / 50Hz) 6-10A = 30\mu F$</p>	<p>3 MCP 6A-M-HA-20μF ~ 230V</p>  <p>$I_N(230V / 50Hz) < 6A = 20\mu F$</p>	<p>4 MCP 10A-M-HA-30μF ~ 230V</p>  <p>$I_N(230V / 50Hz) 6-10A = 30\mu F$</p>
<p>5 CEE16A</p> 	<p>6 CEEM16W</p> 	<p>7 CEEM16WD</p> 	<p>8 MCP T4-HA-ROT-WSK CEE16-5PS</p> 
<p>9 CEE32A</p> 	<p>10 MCP 10-16A-T4-H-ROT CEE32-5PS</p>  <p>CEEM32WD</p>	<p>11 CEEM32WDSHA</p> 	<p>12 CEE63A</p> 

PLUG

Item	Article no.	Description	Quantity
		IN (230V / 50Hz) <6A - 20µF	
1	6072332	MCP 6A-M-H-20µF-CEE7/7 VP.	1
1.1	6071702	capacitor 400V 20µF MCP VP.	1
1.2	6071704	protection switch 6A MCP VP.	1
1.3	6071707	protecting cap MCP VP.	1
		IN (230V / 50Hz) 6-10A - 30µF	
2	6072330	MCP 10A-M-H-30µF-CEE7/7 VP.	1
2.1	6071703	capacitor 400V 30µF MCP VP.	1
2.2	6071705	protection switch 10A MCP VP.	1
2.3	6071707	protecting cap MCP VP.	1
		IN (230V / 50Hz) <6A - 20µF	
3	6072331	MCP 6A-M-HA-20µF-CEE7/7 VP.	1
3.1	6071702	capacitor 400V 20µF MCP VP.	1
3.2	6071704	protection switch 6A MCP VP.	1
3.3	6071707	protecting cap MCP VP.	2
3.4	6071706	switch on/out MCP VP.	1
		IN (230V / 50Hz) 6-10A - 30µF	
4	6072329	MCP 10A-M-HA-30µF-CEE7/7 VP	1
4.1	6071703	capacitor 400V 30µF MCP VP.	1
4.2	6071705	protection switch 10A MCP VP.	1
4.3	6071707	protecting cap MCP VP.	2
4.4	6071706	switch on/out MCP VP.	1
5	6003000	plug CEE16A/400V 60Hz/5P-11h	1
5	6003248	plug CEE16A/400V/4P-6H	1
5	6003009	plug CEE16A/400V/5P-6H	1
5	6039156	plug CEE16A/400V/5P-6H Phase inverter	1
5	6035231	plug CEE16A/400V/7P-6H	1
5	6003011	plug CEE16A/500V/5P-7H	1
6	6030883	plug MS400V5P CEE16A W 1,0-1,6A	1
6	6030884	plug MS400V5P CEE16A W 1,6-2,5A	1
6	6030888	plug MS400V5P CEE16A W 10,0-16,0A	1
6	6030885	plug MS400V5P CEE16A W 2,5-4,0A	1
6	6030886	plug MS400V5P CEE16A W 4,0-6,3A	1
6	6030887	plug MS400V5P CEE16A W 6,3-10,0A	1

PLUG

Item	Article no.	Description	Quantity
7	6032446	plug MS400V4P CEE16A WD 1,6-2,5A	1
7	6032447	plug MS400V4P CEE16A WD 12,5-16,0A	1
7	6032295	plug MS400V4P CEE16A WD 2,5-4,0A	1
7	6032289	plug MS400V4P CEE16A WD 4,0-6,3A	1
7	6032292	plug MS400V4P CEE16A WD 6,3-9,0A	1
7	6042190	plug MS400V5P CEE16A WDII 1,6-2,5A	1
7	6042194	plug MS400V5P CEE16A WDII 10,0-16,0A	1
7	6042191	plug MS400V5P CEE16A WDII 2,5-4,0A	1
7	6042192	plug MS400V5P CEE16A WDII 4,0-6,3A	1
7	6042193	plug MS400V5P CEE16A WDII 6,3-10,0A	1
7	6035911	plug MS400V5P CEE16A WD 9,0-12,5A	1
7	6003337	plug MS500V5P CEE16A WD 1,6-2,5A	1
7	6003336	plug MS500V5P CEE16A WD 2,5-4,0A	1
7	6003335	plug MS500V5P CEE16A WD 4,0-6,3A	1
7	6003334	plug MS500V5P CEE16A WD 6,3-9,0A	1
8	6072520	MCP 1,0-1,6A-T4-HA-ROT-WSK-CEE16-5PS VP.	1
8	6072521	MCP 1,6-2,4A-T4-HA-ROT-WSK-CEE16-5PS VP.	1
8	6072522	MCP 2,4-4,0A-T4-HA-ROT-WSK-CEE16-5PS VP.	1
8	6072523	MCP 4,0-6,0A-T4-HA-ROT-WSK-CEE16-5PS VP.	1
8	6072524	MCP 6,0-10A-T4-HA-ROT-WSK-CEE16-5PS VP.	1
8	6072525	MCP 9,0-12A-T4-HA-ROT-WSK-CEE16-5PS VP.	1
8	6072526	MCP 12-16A-T4-HA-ROT-WSK-CEE16-5PS VP.	1
9	6003267	plug CEE32A/400V/4P-6H	1
9	6039155	plug CEE32A/400V/5P-6H Phase inverter	1
9	6035895	plug CEE32A/500V/4P-7H AM-Top	1
9	6003010	plug CEE32A/500V/5P-7H	1
10	6072370	MCP 400V 1,6-2,5A-T4-H-ROT-CEE32-5PS VP.	1
10	6072369	MCP 400V 2,5-4,0A-T4-H-ROT-CEE32-5PS VP.	1
10	6072371	MCP 400V 4,0-6,3A-T4-H-ROT-CEE32-5PS VP.	1
10	6072398	MCP 400V 6,3-10A-T4-H-ROT-CEE32-5PS VP.	1
10	6072519	MCP 400V 10-16A-T4-H-ROT-CEE32-5PS VP.	1
10	6072399	MCP 400V 16-20A-T4-H-ROT-CEE32-5PS VP.	1
10	6072518	MCP 400V 20-25A-T4-H-ROT-CEE32-5PS VP.	1
10	6037649	plug.MS500V4P CEE32A WD 2,5-4,0A	1

PLUG

Item	Article no.	Description	Quantity
10	6041268	plug MS500V4P CEE32A WD 4,0-6,3A	1
10	6035244	plug MS500V5P CEE32A WD 1,6-2,5A	1
10	6034700	plug MS500V5P CEE32A WD 2,5-4,0A	1
10	6041556	plug MS500V5P CEE32A WD 4,0-6,3A	1
10	6002701	plug MS500V5P CEE32A WD 9,0-12,5A	1
10	6002700	plug MS500V5P CEE32A WD 12,5-16,0A	1
11	6003241	plug MS400V5P CEE32A WDSHA 10,0-14,0A	1
11	6003266	plug MS400V5P CEE32A WDSHA 3,7-5,5A	1
11	6003265	plug MS400V5P CEE32A WDSHA 5,5-8,0A	1
11	6003264	plug MS400V5P CEE32A WDSHA 8,0-11,5A	1
12	6003012	plug CEE63A/400V/5P-6H/IP67	1

CONTRACTOR'S PUMP KS37ZH UNIT (6000101)

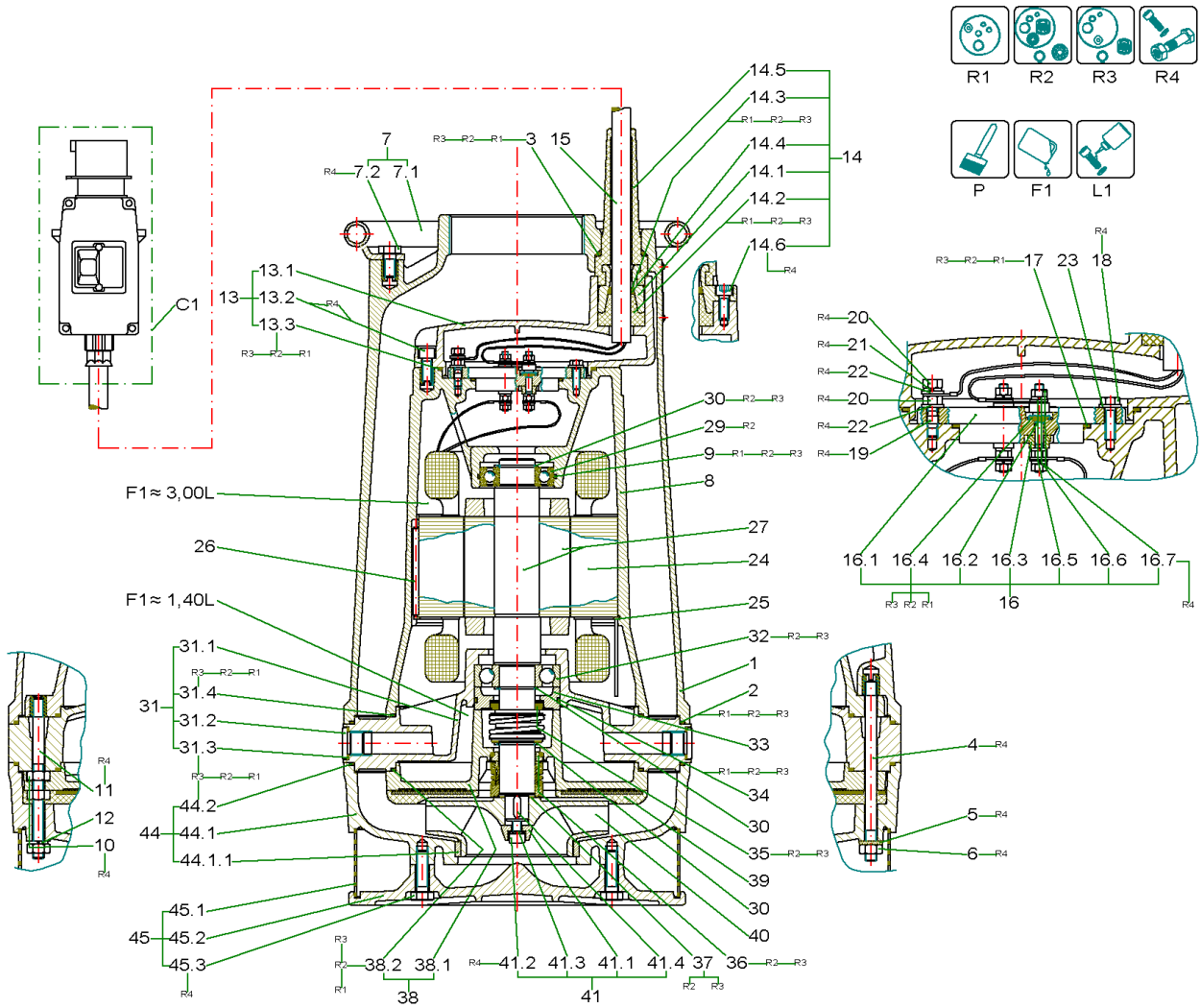

CONTRACTOR'S PUMP KS37ZH UNIT (6000101)

Item	Article no.	Description	Quantity
R1	6016259	Rep.Kit 1 KS37,70+Z Vit	1
R2	6016303	Rep.Kit 2 KS37,70 +Z Vit	1
R3	6016304	Rep.Kit 3 KS37,70+Z Vit	1
R4	6016128	Screws KS37,70 + Z KIT	1
P	6042254	PAINT SPRAY Pantone334	1
P	6042255	colour 2K-paint IV80 pantone334C 250ml	1
P	6023614	Ceram C0 black 100 ml KIT	1
P	6020579	Ceram C0 black 250 ml KIT	1
P	6023485	Ceram C0 Black 500ml Kit	1
P	6019157	Ceram C0 black 1000 ml KIT	1
F1	6025461	medical white oil 5L KIT	1
F1	6025460	medical white oil 1L KIT	1
L1	6080531	Loctite 243 5g flask VP:	1
L1	2096167	Loctite 243 50ml VP.	1

C1		PLUG	1

1	6017708	pump shroud ZG4 51.1653 Al	1
		alternativ / alternative / alternative	
1	6017707	pump shroud ZG4 51.1653 Al/C0	1
2		o-ring ID.270,0x3,0 Viton	1
3		o-ring ID.34,52x3,53 Viton	1
4		screw M10x140 DIN939 A2-70	4
5		Dubo-washer M10 NR.205 PA	4
6		nut M10 DIN934 A4-80 (20pc)	1
7	6001390	handle 52.1592 St vz KIT	1
7.1		> handle 52.1592 Stvz	1
7.2		> screw M10x20 DIN933 A4-70	4
		alternativ / alternative / alternative	
7.1	6016512	handle 52.1592 Stvz/C0	1
8	6013895	motor casing 50.1704 Al	1
		alternativ / alternative / alternative	
8	6013894	motor casing 50.1704 Al/C0	1
9	6078160	o-ring ID.62,0x3,0 Viton (3pc)	1

CONTRACTOR'S PUMP KS37ZH UNIT (6000101)

Item	Article no.	Description	Quantity
10		nut M10 DIN934 A4-80 (20pc)	1
11		screw M10x120 A2	2
12		lock washer 10 DIN7980 A4 (10pc)	1
13	6001675	motor cover 52.1695 GG KIT	1
13.1		> motor cover D.126g6 52.1695 GG	1
13.2		> screw M8x20 ISO4762 A2-70	5
13.3		> o-ring ID.122,0x3,0 Viton	1
		alternativ / alternative / alternative	
13.1	6013978	motor cover D.126g6 52.1695 GG/C0	1
		Für Einschaltung Direkt	
		For direct-on-line starting	
		Pour démarrage direct	
14	6001886	cable gland 54.5696 GG KIT	1
14.1		> cable gland 54.5696 GG	1
14.2		> seal ring-profile 1646 Gi	1
14.3		> pressure ring 20,5 16 0,8 PG16 DIN46320	1
14.4		> o-ring ID.13,0x3,5 Viton	1
14.5	6003826	> cable protection 140x45 mm NR50° Shore	1
14.6		> screw M8x20 ISO4762 A2-70	2
15	6007632	cable NSSHÖU-J 4x1,5 round	
16	6001670	terminal board Melaminharz KIT	1
16.1		> terminal board Melaminharz	1
16.2		> duct bolt SW13x50 Ms	3
16.3		> pressure ring MS raw	3
16.4		> o-ring ID.5,0x2,0 NBR70	3
16.5		> washer A5,3 DIN125 A4	6
16.6		> lock washer 5 DIN7980 A4	9
16.7		> nut M5 DIN934 Ms	9
		Für Einschaltung Stern/Dreieck	
		For starting star-delta	
		Pour démarrage étoile-triangle	
14	6018980	cable gland 54. 5696 GG KIT	1
14.1		> cable gland 54.5696 GG	1
14.2		> seal ring-profile 5612 CR	1

CONTRACTOR'S PUMP KS37ZH UNIT (6000101)

Item	Article no.	Description	Quantity
14.3		> pressure ring 20,5 16 0,8 PG16 DIN46320	1
14.4		> o-ring ID.16,0x4,5 Viton	1
14.5	6003826	> cable protection 140x45 mm NR50° Shore	1
14.6		> screw M8x20 ISO4762 A2-70	2
15	6007534	cable NSSHÖU-J 7x1,5 round	
16	6024844	terminal board 53.11698 KIT	1
16.1		> terminal board Melaminharz	1
16.2		> duct bolt SW13x50 Ms	6
16.3		> pressure ring MS raw	6
16.4		> o-ring ID.5,0x2,0 NBR70	6
16.5		> washer A5,3 DIN125 A4	12
16.6		> lock washer 5 DIN7980 A4	18
16.7		> nut M5 DIN934 Ms	18

17		o-ring ID.65,0x3,0 Viton	1
18		screw M6x20 ISO4017 A2-70	3
19		screw M6x25 DIN939 A2-70	1
20		nut M6 DIN934 A4-80	2
21		lock washer 6 DIN7980 A4	1
22		washer A6,4 DIN125 A4	2
23		washer A6,4 DIN125 A4	3
24	6023486	stator F17-2/8 400/690 50Hz	1
		alternativ / alternative / alternative	
24	6023505	stator F17-2/8 230/400 50Hz	1
24	6023508	stator F17-2/8 500 50Hz VN01	1
25	6004661	circlips 174x2 54.1637 FSt	1
26	6035802	safety bar D.5x75 54.19444 St	1
27	6009995	rotor D.89x306 2/8 1.4021	1
29	6078164	ball bearing 6206 DDU C3 VP.	1
30	501355698	CIRCLIP 30X1,5 DIN471 FST	1
31	6001374	bearing housing U 51.1699 AI KIT	1
31.1		> bearing housing U 51.1699 AI	1
31.2	6067638	> screw plug G1/2 DIN908 A4 (3pcs)	1
31.3	6048832	> joint ring A21/26x1,5 DIN7603 PA(10pc)	1

CONTRACTOR'S PUMP KS37ZH UNIT (6000101)

Item	Article no.	Description	Quantity
31.4	6076642	> o-ring ID.203,0x3,0 Viton (3pc) alternativ / alternative / alternative	1
31.1	6013940	bearing housing U 51.1699 Al/C0	1
31.1	6019019	bearing housing U 51.1699 Al/C1	1
32	6008974	ball bearing 6306	1
30	501355698	CIRCLIP 30X1,5 DIN471 FST	1
33	6009373	pressure ring D.72/39,2x19,1 55.1689 GG	1
34		o-ring ID.65,0x3,0 Viton	1
35	6077844	mech.seal MG1/30-G60-E1AQ1PGG VP. alternativ / alternative / alternative	1
35	6074586	GRD. MG1/30-G4 Q1Q1VGG VP.	1
30	501355698	CIRCLIP 30X1,5 DIN471 FST	1
36	6074586	GRD. MG1/30-G4 Q1Q1VGG VP.	1
37	6002123	washer D.44/20x1 1.4301 -	1
38	6001372	sealing casing 52.1698/1 Al KIT	1
38.1		> sealing casing D.205g6 52.1698/1 Al	1
38.2	6076642	> o-ring ID.203,0x3,0 Viton (3pc) alternativ / alternative / alternative	1
38.1	6013727	sealing casing D.205 52.1698/1 Al/C0	1
39	6075378	wear plate 53.1693 Neoprene VP. Laufrad / Impeller / Roue 50Hz	1
40	6014072	impeller-M D.175 53.1223 GGG alternativ / alternative / alternative	1
40	6021697	impeller-M D.175 53.1223 GGG/C0 Laufrad / Impeller / Roue 60Hz	1
40	6014073	impeller-M D.155 54.1129 GGG alternativ / alternative / alternative	1
40	6021696	impeller-M D.155 54.1129 GGG/C0	1
41	6043597	impeller fixation 55.5399/1 1.4021 KIT	1
41.1		> washer D.26/9x13 55.5399/1	1
41.2	6003416	> screw M8x25 DIN912 10.9 Geomet	1
41.3	6002688	> screw locking Nord-Lock 13,5/8,7 A4	1
41.4	6004654	> key A 6x4x18 54.2589 A4	1
44	6001370	pump housing A 51.1702 GG KIT	1

CONTRACTOR'S PUMP KS37ZH UNIT (6000101)

Item	Article no.	Description	Quantity
44.1		> pump housing A 51.1702 GG	1
44.2		> o-ring ID.270,0x3,0 Viton	1
44.1.1	6073152	neck ring D.105x13 6051846 1.4470 VP.	1
		alternativ / alternative / alternative	
44.1	6012861	pump housing A 51.1702 GG/C0	1
44.1	6012830	pump housing A 51.1702 GG/C1C1	1
44.1	6012845	pump housing A 51.1702 GG/C2C1	1
44.1	6012909	pump housing A 51.16785 1.4581	1
44.1	6022771	pump housing A 51.19190 Abrasit	1
44.1	6022779	pump housing A 53.19190 Abrasit/C0	1
45	6001371	strainer 53.17962 1.4301 KIT	1
45.1		> strainer 57x273x2 53.17962 1.4301	1
45.2		> base plate D.284 52.17961 Al	1
45.3		> screw M10x35 DIN933 A2-70	4
		alternativ / alternative / alternative	
45.1	6013069	strainer 57x273x2 53.17962 1.4301/CO	1

<p>1 MCP 6A-M-H-20μF ~ 230V</p> <p>$I_N(230V / 50Hz) < 6A = 20\mu F$</p>	<p>2 MCP 10A-M-H-30μF ~ 230V</p> <p>$I_N(230V / 50Hz) 6-10A = 30\mu F$</p>	<p>3 MCP 6A-M-HA-20μF ~ 230V</p> <p>$I_N(230V / 50Hz) < 6A = 20\mu F$</p>	<p>4 MCP 10A-M-HA-30μF ~ 230V</p> <p>$I_N(230V / 50Hz) 6-10A = 30\mu F$</p>
<p>5 CEE16A</p>	<p>6 CEEM16W</p>	<p>7 CEEM16WD</p>	<p>8 MCP T4-HA-ROT-WSK CEE16-5PS</p>
<p>9 CEE32A</p>	<p>10 MCP 10-16A-T4-H-ROT CEE32-5PS</p> <p>CEEM32WD</p>	<p>11 CEEM32WDSHA</p>	<p>12 CEE63A</p>

PLUG

Item	Article no.	Description	Quantity
		IN (230V / 50Hz) <6A - 20µF	
1	6072332	MCP 6A-M-H-20µF-CEE7/7 VP.	1
1.1	6071702	capacitor 400V 20µF MCP VP.	1
1.2	6071704	protection switch 6A MCP VP.	1
1.3	6071707	protecting cap MCP VP.	1
		IN (230V / 50Hz) 6-10A - 30µF	
2	6072330	MCP 10A-M-H-30µF-CEE7/7 VP.	1
2.1	6071703	capacitor 400V 30µF MCP VP.	1
2.2	6071705	protection switch 10A MCP VP.	1
2.3	6071707	protecting cap MCP VP.	1
		IN (230V / 50Hz) <6A - 20µF	
3	6072331	MCP 6A-M-HA-20µF-CEE7/7 VP.	1
3.1	6071702	capacitor 400V 20µF MCP VP.	1
3.2	6071704	protection switch 6A MCP VP.	1
3.3	6071707	protecting cap MCP VP.	2
3.4	6071706	switch on/out MCP VP.	1
		IN (230V / 50Hz) 6-10A - 30µF	
4	6072329	MCP 10A-M-HA-30µF-CEE7/7 VP	1
4.1	6071703	capacitor 400V 30µF MCP VP.	1
4.2	6071705	protection switch 10A MCP VP.	1
4.3	6071707	protecting cap MCP VP.	2
4.4	6071706	switch on/out MCP VP.	1
5	6003000	plug CEE16A/400V 60Hz/5P-11h	1
5	6003248	plug CEE16A/400V/4P-6H	1
5	6003009	plug CEE16A/400V/5P-6H	1
5	6039156	plug CEE16A/400V/5P-6H Phase inverter	1
5	6035231	plug CEE16A/400V/7P-6H	1
5	6003011	plug CEE16A/500V/5P-7H	1
6	6030883	plug MS400V5P CEE16A W 1,0-1,6A	1
6	6030884	plug MS400V5P CEE16A W 1,6-2,5A	1
6	6030888	plug MS400V5P CEE16A W 10,0-16,0A	1
6	6030885	plug MS400V5P CEE16A W 2,5-4,0A	1
6	6030886	plug MS400V5P CEE16A W 4,0-6,3A	1
6	6030887	plug MS400V5P CEE16A W 6,3-10,0A	1

PLUG

Item	Article no.	Description	Quantity
7	6032446	plug MS400V4P CEE16A WD 1,6-2,5A	1
7	6032447	plug MS400V4P CEE16A WD 12,5-16,0A	1
7	6032295	plug MS400V4P CEE16A WD 2,5-4,0A	1
7	6032289	plug MS400V4P CEE16A WD 4,0-6,3A	1
7	6032292	plug MS400V4P CEE16A WD 6,3-9,0A	1
7	6042190	plug MS400V5P CEE16A WDII 1,6-2,5A	1
7	6042194	plug MS400V5P CEE16A WDII 10,0-16,0A	1
7	6042191	plug MS400V5P CEE16A WDII 2,5-4,0A	1
7	6042192	plug MS400V5P CEE16A WDII 4,0-6,3A	1
7	6042193	plug MS400V5P CEE16A WDII 6,3-10,0A	1
7	6035911	plug MS400V5P CEE16A WD 9,0-12,5A	1
7	6003337	plug MS500V5P CEE16A WD 1,6-2,5A	1
7	6003336	plug MS500V5P CEE16A WD 2,5-4,0A	1
7	6003335	plug MS500V5P CEE16A WD 4,0-6,3A	1
7	6003334	plug MS500V5P CEE16A WD 6,3-9,0A	1
8	6072520	MCP 1,0-1,6A-T4-HA-ROT-WSK-CEE16-5PS VP.	1
8	6072521	MCP 1,6-2,4A-T4-HA-ROT-WSK-CEE16-5PS VP.	1
8	6072522	MCP 2,4-4,0A-T4-HA-ROT-WSK-CEE16-5PS VP.	1
8	6072523	MCP 4,0-6,0A-T4-HA-ROT-WSK-CEE16-5PS VP.	1
8	6072524	MCP 6,0-10A-T4-HA-ROT-WSK-CEE16-5PS VP.	1
8	6072525	MCP 9,0-12A-T4-HA-ROT-WSK-CEE16-5PS VP.	1
8	6072526	MCP 12-16A-T4-HA-ROT-WSK-CEE16-5PS VP.	1
9	6003267	plug CEE32A/400V/4P-6H	1
9	6039155	plug CEE32A/400V/5P-6H Phase inverter	1
9	6035895	plug CEE32A/500V/4P-7H AM-Top	1
9	6003010	plug CEE32A/500V/5P-7H	1
10	6072370	MCP 400V 1,6-2,5A-T4-H-ROT-CEE32-5PS VP.	1
10	6072369	MCP 400V 2,5-4,0A-T4-H-ROT-CEE32-5PS VP.	1
10	6072371	MCP 400V 4,0-6,3A-T4-H-ROT-CEE32-5PS VP.	1
10	6072398	MCP 400V 6,3-10A-T4-H-ROT-CEE32-5PS VP.	1
10	6072519	MCP 400V 10-16A-T4-H-ROT-CEE32-5PS VP.	1
10	6072399	MCP 400V 16-20A-T4-H-ROT-CEE32-5PS VP.	1
10	6072518	MCP 400V 20-25A-T4-H-ROT-CEE32-5PS VP.	1
10	6037649	plug.MS500V4P CEE32A WD 2,5-4,0A	1

PLUG

Item	Article no.	Description	Quantity
10	6041268	plug MS500V4P CEE32A WD 4,0-6,3A	1
10	6035244	plug MS500V5P CEE32A WD 1,6-2,5A	1
10	6034700	plug MS500V5P CEE32A WD 2,5-4,0A	1
10	6041556	plug MS500V5P CEE32A WD 4,0-6,3A	1
10	6002701	plug MS500V5P CEE32A WD 9,0-12,5A	1
10	6002700	plug MS500V5P CEE32A WD 12,5-16,0A	1
11	6003241	plug MS400V5P CEE32A WDSHA 10,0-14,0A	1
11	6003266	plug MS400V5P CEE32A WDSHA 3,7-5,5A	1
11	6003265	plug MS400V5P CEE32A WDSHA 5,5-8,0A	1
11	6003264	plug MS400V5P CEE32A WDSHA 8,0-11,5A	1
12	6003012	plug CEE63A/400V/5P-6H/IP67	1

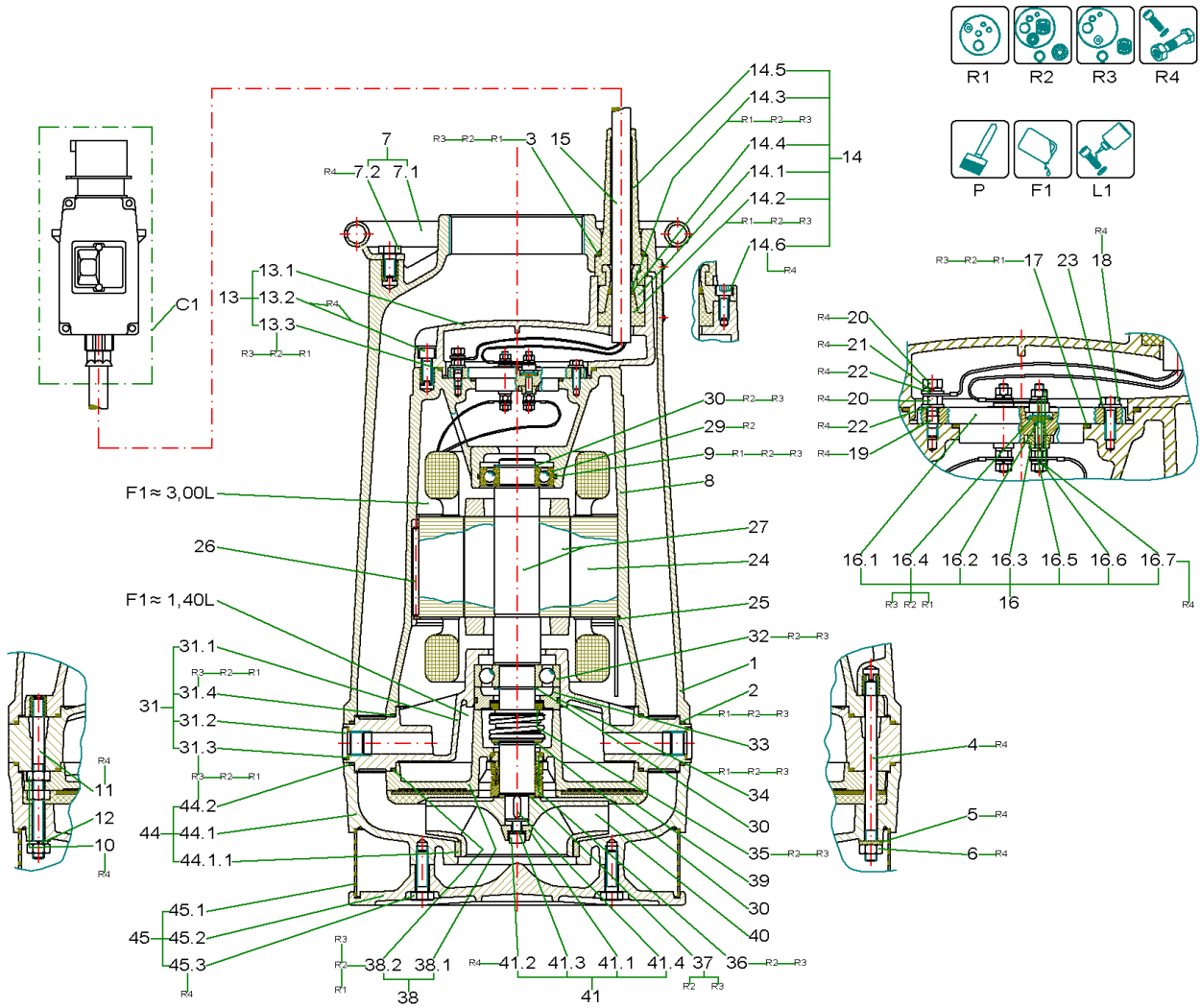

CONTRACTOR'S PUMP KS37ZM UNIT (6000102)

Item	Article no.	Description	Quantity
R1	6016259	Rep.Kit 1 KS37,70+Z Vit	1
R2	6016303	Rep.Kit 2 KS37,70 +Z Vit	1
R3	6016304	Rep.Kit 3 KS37,70+Z Vit	1
R4	6016128	Screws KS37,70 + Z KIT	1
P	6042254	PAINT SPRAY Pantone334	1
P	6042255	colour 2K-paint IV80 pantone334C 250ml	1
P	6023614	Ceram C0 black 100 ml KIT	1
P	6020579	Ceram C0 black 250 ml KIT	1
P	6023485	Ceram C0 Black 500ml Kit	1
P	6019157	Ceram C0 black 1000 ml KIT	1
F1	6025461	medical white oil 5L KIT	1
F1	6025460	medical white oil 1L KIT	1
L1	6080531	Loctite 243 5g flask VP:	1
L1	2096167	Loctite 243 50ml VP.	1

C1		PLUG	1

1	6017708	pump shroud ZG4 51.1653 Al	1
		alternativ / alternative / alternative	
1	6017707	pump shroud ZG4 51.1653 Al/C0	1
2		o-ring ID.270,0x3,0 Viton	1
3		o-ring ID.34,52x3,53 Viton	1
4		screw M10x140 DIN939 A2-70	4
5		Dubo-washer M10 NR.205 PA	4
6		nut M10 DIN934 A4-80 (20pc)	1
7	6001390	handle 52.1592 St vz KIT	1
7.1		> handle 52.1592 Stvz	1
7.2		> screw M10x20 DIN933 A4-70	4
		alternativ / alternative / alternative	
7.1	6016512	handle 52.1592 Stvz/C0	1
8	6013895	motor casing 50.1704 Al	1
		alternativ / alternative / alternative	
8	6013894	motor casing 50.1704 Al/C0	1
9	6078160	o-ring ID.62,0x3,0 Viton (3pc)	1

CONTRACTOR'S PUMP KS37ZM UNIT (6000102)

Item	Article no.	Description	Quantity
10		nut M10 DIN934 A4-80 (20pc)	1
11		screw M10x120 A2	2
12		lock washer 10 DIN7980 A4 (10pc)	1
13	6001675	motor cover 52.1695 GG KIT	1
13.1		> motor cover D.126g6 52.1695 GG	1
13.2		> screw M8x20 ISO4762 A2-70	5
13.3		> o-ring ID.122,0x3,0 Viton	1
		alternativ / alternative / alternative	
13.1	6013978	motor cover D.126g6 52.1695 GG/C0	1
		Für Einschaltung Direkt	
		For direct-on-line starting	
		Pour démarrage direct	
14	6001886	cable gland 54.5696 GG KIT	1
14.1		> cable gland 54.5696 GG	1
14.2		> seal ring-profile 1646 Gi	1
14.3		> pressure ring 20,5 16 0,8 PG16 DIN46320	1
14.4		> o-ring ID.13,0x3,5 Viton	1
14.5	6003826	> cable protection 140x45 mm NR50° Shore	1
14.6		> screw M8x20 ISO4762 A2-70	2
15	6007632	cable NSSHÖU-J 4x1,5 round	
16	6001670	terminal board Melaminharz KIT	1
16.1		> terminal board Melaminharz	1
16.2		> duct bolt SW13x50 Ms	3
16.3		> pressure ring MS raw	3
16.4		> o-ring ID.5,0x2,0 NBR70	3
16.5		> washer A5,3 DIN125 A4	6
16.6		> lock washer 5 DIN7980 A4	9
16.7		> nut M5 DIN934 Ms	9
		Für Einschaltung Stern/Dreieck	
		For starting star-delta	
		Pour démarrage étoile-triangle	
14	6018980	cable gland 54. 5696 GG KIT	1
14.1		> cable gland 54.5696 GG	1
14.2		> seal ring-profile 5612 CR	1

CONTRACTOR'S PUMP KS37ZM UNIT (6000102)

Item	Article no.	Description	Quantity
14.3		> pressure ring 20,5 16 0,8 PG16 DIN46320	1
14.4		> o-ring ID.16,0x4,5 Viton	1
14.5	6003826	> cable protection 140x45 mm NR50° Shore	1
14.6		> screw M8x20 ISO4762 A2-70	2
15	6007534	cable NSSHÖU-J 7x1,5 round	
16	6024844	terminal board 53.11698 KIT	1
16.1		> terminal board Melaminharz	1
16.2		> duct bolt SW13x50 Ms	6
16.3		> pressure ring MS raw	6
16.4		> o-ring ID.5,0x2,0 NBR70	6
16.5		> washer A5,3 DIN125 A4	12
Note: nur in Verwendung mit dem Pumpengehäuse / only for use with pump casing / seulement pour l`emploi avec le corps de pompe en 6023613			
16.6		> lock washer 5 DIN7980 A4	18
Note: nur in Verwendung mit dem Wirbelstromlaufrad / only for use with vortex impeller / seulement pour l`emploi avec la roue vortex 6023612			
16.7		> nut M5 DIN934 Ms	18

17		o-ring ID.65,0x3,0 Viton	1
18		screw M6x20 ISO4017 A2-70	3
19		screw M6x25 DIN939 A2-70	1
20		nut M6 DIN934 A4-80	2
21		lock washer 6 DIN7980 A4	1
22		washer A6,4 DIN125 A4	2
23		washer A6,4 DIN125 A4	3
24	6023486	stator F17-2/8 400/690 50Hz	1
alternativ / alternative / alternative			
24	6023505	stator F17-2/8 230/400 50Hz	1
24	6023508	stator F17-2/8 500 50Hz VN01	1
25	6004661	circlips 174x2 54.1637 FSt	1
26	6035802	safety bar D.5x75 54.19444 St	1
27	6009995	rotor D.89x306 2/8 1.4021	1
29	6078164	ball bearing 6206 DDU C3 VP.	1
30	501355698	CIRCLIP 30X1,5 DIN471 FST	1
31	6001374	bearing housing U 51.1699 AI KIT	1

CONTRACTOR'S PUMP KS37ZM UNIT (6000102)

Item	Article no.	Description	Quantity
31.1		> bearing housing U 51.1699 Al	1
31.2	6067638	> screw plug G1/2 DIN908 A4 (3pcs)	1
31.3	6048832	> joint ring A21/26x1,5 DIN7603 PA(10pc)	1
31.4	6076642	> o-ring ID.203,0x3,0 Viton (3pc)	1
		alternativ / alternative / alternative	
31.1	6013940	bearing housing U 51.1699 Al/C0	1
31.1	6019019	bearing housing U 51.1699 Al/C1	1
32	6008974	ball bearing 6306	1
30	501355698	CIRCLIP 30X1,5 DIN471 FST	1
33	6009373	pressure ring D.72/39,2x19,1 55.1689 GG	1
34		o-ring ID.65,0x3,0 Viton	1
35	6077844	mech.seal MG1/30-G60-E1AQ1PGG VP.	1
		alternativ / alternative / alternative	
35	6074586	GRD. MG1/30-G4 Q1Q1VGG VP.	1
30	501355698	CIRCLIP 30X1,5 DIN471 FST	1
36	6074586	GRD. MG1/30-G4 Q1Q1VGG VP.	1
37	6002123	washer D.44/20x1 1.4301 -	1
38	6001372	sealing casing 52.1698/1 Al KIT	1
38.1		> sealing casing D.205g6 52.1698/1 Al	1
38.2	6076642	> o-ring ID.203,0x3,0 Viton (3pc)	1
		alternativ / alternative / alternative	
38.1	6013727	sealing casing D.205 52.1698/1 Al/C0	1
39	6075378	wear plate 53.1693 Neoprene VP.	1
		Laufrad / Impeller / Roue 50Hz	
40	6014033	impeller-M D.148 53.3554/1 GGG	1
		alternativ / alternative / alternative	
40	6001403	impeller-M D.148 53.3554/1 GGG/C0	1
40	6014157	impeller-M D.148 53.17063 Abrasit	1
40	6024255	impeller-M D.148 53.17063 Abrasit/CO	1
40	6014021	impeller-M D.148 53.3554/1 1.4581	1
		Laufrad / Impeller / Roue 60Hz	
40	6014020	impeller-M D.135 53.3554/2 GGG	1
		alternativ / alternative / alternative	
40	6021744	impeller-M D.135 53.3554/2 GGG/C0	1

CONTRACTOR'S PUMP KS37ZM UNIT (6000102)

Item	Article no.	Description	Quantity
40	6022774	impeller-M D.135 53.19185 Abrasit	1
40	6024257	impeller-M D.135 53.19185 Abrasit/CO	1
40	6021651	impeller-M D.135 53.3554/2 1.4581	1
41	6043597	impeller fixation 55.5399/1 1.4021 KIT	1
41.1		> washer D.26/9x13 55.5399/1	1
41.2	6003416	> screw M8x25 DIN912 10.9 Geomet	1
41.3	6002688	> screw locking Nord-Lock 13,5/8,7 A4	1
41.4	6004654	> key A 6x4x18 54.2589 A4	1
44	6001370	pump housing A 51.1702 GG KIT	1
44.1		> pump housing A 51.1702 GG	1
44.2		> o-ring ID.270,0x3,0 Viton	1
44.1.1	6073152	neck ring D.105x13 6051846 1.4470 VP. alternativ / alternative / alternative	1
44.1	6012861	pump housing A 51.1702 GG/CO	1
44.1	6012830	pump housing A 51.1702 GG/C1C1	1
44.1	6012845	pump housing A 51.1702 GG/C2C1	1
44.1	6012909	pump housing A 51.16785 1.4581	1
44.1	6022771	pump housing A 51.19190 Abrasit	1
44.1	6022779	pump housing A 53.19190 Abrasit/CO	1
45	6001371	strainer 53.17962 1.4301 KIT	1
45.1		> strainer 57x273x2 53.17962 1.4301	1
45.2		> base plate D.284 52.17961 Al	1
45.3		> screw M10x35 DIN933 A2-70	4
		alternativ / alternative / alternative	
45.1	6013069	strainer 57x273x2 53.17962 1.4301/CO ----- No longer available	1
		Sonderausführung Freistromhydraulik / special design: vortex hydraulic / exécu. spéciale: hydraulic vortex	
40		impeller-W KS 37 1.4825	1
Note: nur in Verwendung mit dem Pumpengehäuse/ only for use with pump casing /			
44.1		pump housing A KS 37 1.4825	1
Note: nur in Verwendung mit dem Wirbelstromlaufrad / only for use with			

Item	Article no.	Description	Quantity
------	-------------	-------------	----------

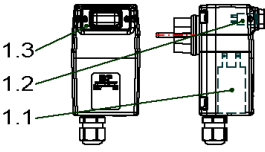
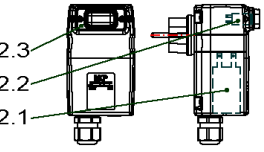
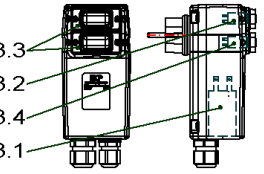
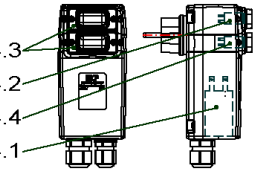
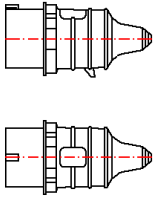
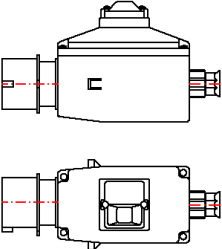
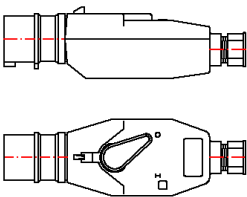
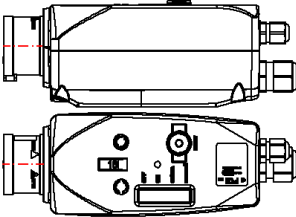
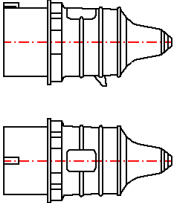
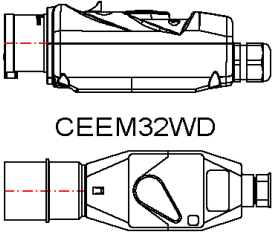
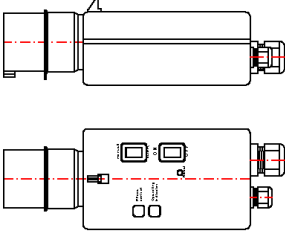
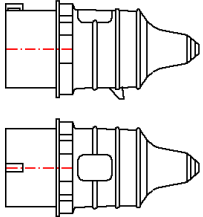
<p>1 MCP 6A-M-H-20μF ~ 230V</p>  <p>$I_N(230V / 50Hz) < 6A = 20\mu F$</p>	<p>2 MCP 10A-M-H-30μF ~ 230V</p>  <p>$I_N(230V / 50Hz) 6-10A = 30\mu F$</p>	<p>3 MCP 6A-M-HA-20μF ~ 230V</p>  <p>$I_N(230V / 50Hz) < 6A = 20\mu F$</p>	<p>4 MCP 10A-M-HA-30μF ~ 230V</p>  <p>$I_N(230V / 50Hz) 6-10A = 30\mu F$</p>
<p>5 CEE16A</p> 	<p>6 CEEM16W</p> 	<p>7 CEEM16WD</p> 	<p>8 MCP T4-HA-ROT-WSK CEE16-5PS</p> 
<p>9 CEE32A</p> 	<p>10 MCP 10-16A-T4-H-ROT CEE32-5PS</p>  <p>CEEM32WD</p>	<p>11 CEEM32WDSHA</p> 	<p>12 CEE63A</p> 

PLUG

Item	Article no.	Description	Quantity
		IN (230V / 50Hz) <6A - 20μF	
1	6072332	MCP 6A-M-H-20μF-CEE7/7 VP.	1
1.1	6071702	capacitor 400V 20μF MCP VP.	1
1.2	6071704	protection switch 6A MCP VP.	1
1.3	6071707	protecting cap MCP VP.	1
		IN (230V / 50Hz) 6-10A - 30μF	
2	6072330	MCP 10A-M-H-30μF-CEE7/7 VP.	1
2.1	6071703	capacitor 400V 30μF MCP VP.	1
2.2	6071705	protection switch 10A MCP VP.	1
2.3	6071707	protecting cap MCP VP.	1
		IN (230V / 50Hz) <6A - 20μF	
3	6072331	MCP 6A-M-HA-20μF-CEE7/7 VP.	1
3.1	6071702	capacitor 400V 20μF MCP VP.	1
3.2	6071704	protection switch 6A MCP VP.	1
3.3	6071707	protecting cap MCP VP.	2
3.4	6071706	switch on/out MCP VP.	1
		IN (230V / 50Hz) 6-10A - 30μF	
4	6072329	MCP 10A-M-HA-30μF-CEE7/7 VP	1
4.1	6071703	capacitor 400V 30μF MCP VP.	1
4.2	6071705	protection switch 10A MCP VP.	1
4.3	6071707	protecting cap MCP VP.	2
4.4	6071706	switch on/out MCP VP.	1
5	6003000	plug CEE16A/400V 60Hz/5P-11h	1
5	6003248	plug CEE16A/400V/4P-6H	1
5	6003009	plug CEE16A/400V/5P-6H	1
5	6039156	plug CEE16A/400V/5P-6H Phase inverter	1
5	6035231	plug CEE16A/400V/7P-6H	1
5	6003011	plug CEE16A/500V/5P-7H	1
6	6030883	plug MS400V5P CEE16A W 1,0-1,6A	1
6	6030884	plug MS400V5P CEE16A W 1,6-2,5A	1
6	6030888	plug MS400V5P CEE16A W 10,0-16,0A	1
6	6030885	plug MS400V5P CEE16A W 2,5-4,0A	1
6	6030886	plug MS400V5P CEE16A W 4,0-6,3A	1
6	6030887	plug MS400V5P CEE16A W 6,3-10,0A	1

PLUG

Item	Article no.	Description	Quantity
7	6032446	plug MS400V4P CEE16A WD 1,6-2,5A	1
7	6032447	plug MS400V4P CEE16A WD 12,5-16,0A	1
7	6032295	plug MS400V4P CEE16A WD 2,5-4,0A	1
7	6032289	plug MS400V4P CEE16A WD 4,0-6,3A	1
7	6032292	plug MS400V4P CEE16A WD 6,3-9,0A	1
7	6042190	plug MS400V5P CEE16A WDII 1,6-2,5A	1
7	6042194	plug MS400V5P CEE16A WDII 10,0-16,0A	1
7	6042191	plug MS400V5P CEE16A WDII 2,5-4,0A	1
7	6042192	plug MS400V5P CEE16A WDII 4,0-6,3A	1
7	6042193	plug MS400V5P CEE16A WDII 6,3-10,0A	1
7	6035911	plug MS400V5P CEE16A WD 9,0-12,5A	1
7	6003337	plug MS500V5P CEE16A WD 1,6-2,5A	1
7	6003336	plug MS500V5P CEE16A WD 2,5-4,0A	1
7	6003335	plug MS500V5P CEE16A WD 4,0-6,3A	1
7	6003334	plug MS500V5P CEE16A WD 6,3-9,0A	1
8	6072520	MCP 1,0-1,6A-T4-HA-ROT-WSK-CEE16-5PS VP.	1
8	6072521	MCP 1,6-2,4A-T4-HA-ROT-WSK-CEE16-5PS VP.	1
8	6072522	MCP 2,4-4,0A-T4-HA-ROT-WSK-CEE16-5PS VP.	1
8	6072523	MCP 4,0-6,0A-T4-HA-ROT-WSK-CEE16-5PS VP.	1
8	6072524	MCP 6,0-10A-T4-HA-ROT-WSK-CEE16-5PS VP.	1
8	6072525	MCP 9,0-12A-T4-HA-ROT-WSK-CEE16-5PS VP.	1
8	6072526	MCP 12-16A-T4-HA-ROT-WSK-CEE16-5PS VP.	1
9	6003267	plug CEE32A/400V/4P-6H	1
9	6039155	plug CEE32A/400V/5P-6H Phase inverter	1
9	6035895	plug CEE32A/500V/4P-7H AM-Top	1
9	6003010	plug CEE32A/500V/5P-7H	1
10	6072370	MCP 400V 1,6-2,5A-T4-H-ROT-CEE32-5PS VP.	1
10	6072369	MCP 400V 2,5-4,0A-T4-H-ROT-CEE32-5PS VP.	1
10	6072371	MCP 400V 4,0-6,3A-T4-H-ROT-CEE32-5PS VP.	1
10	6072398	MCP 400V 6,3-10A-T4-H-ROT-CEE32-5PS VP.	1
10	6072519	MCP 400V 10-16A-T4-H-ROT-CEE32-5PS VP.	1
10	6072399	MCP 400V 16-20A-T4-H-ROT-CEE32-5PS VP.	1
10	6072518	MCP 400V 20-25A-T4-H-ROT-CEE32-5PS VP.	1
10	6037649	plug.MS500V4P CEE32A WD 2,5-4,0A	1

PLUG

Item	Article no.	Description	Quantity
10	6041268	plug MS500V4P CEE32A WD 4,0-6,3A	1
10	6035244	plug MS500V5P CEE32A WD 1,6-2,5A	1
10	6034700	plug MS500V5P CEE32A WD 2,5-4,0A	1
10	6041556	plug MS500V5P CEE32A WD 4,0-6,3A	1
10	6002701	plug MS500V5P CEE32A WD 9,0-12,5A	1
10	6002700	plug MS500V5P CEE32A WD 12,5-16,0A	1
11	6003241	plug MS400V5P CEE32A WDSHA 10,0-14,0A	1
11	6003266	plug MS400V5P CEE32A WDSHA 3,7-5,5A	1
11	6003265	plug MS400V5P CEE32A WDSHA 5,5-8,0A	1
11	6003264	plug MS400V5P CEE32A WDSHA 8,0-11,5A	1
12	6003012	plug CEE63A/400V/5P-6H/IP67	1

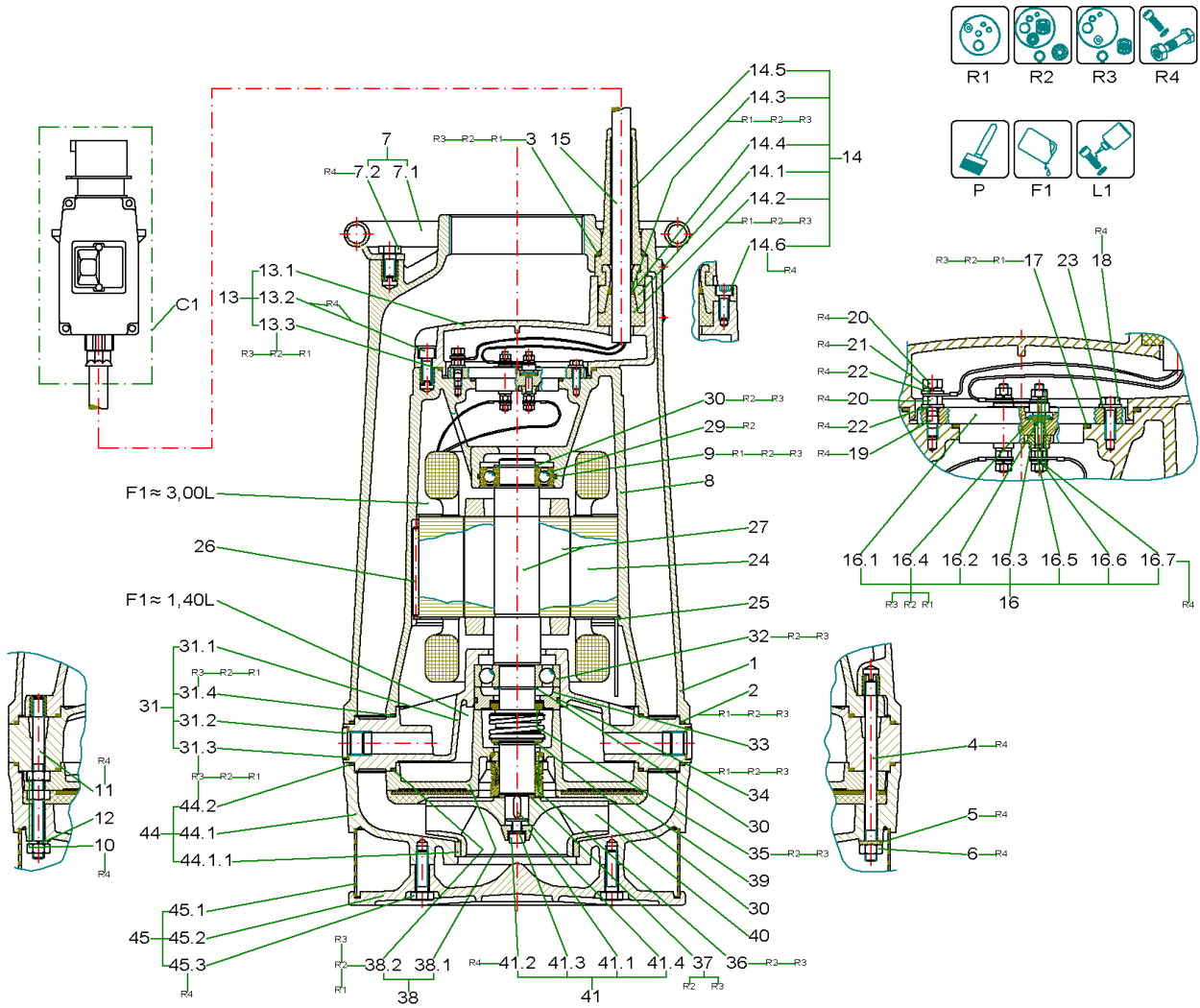

CONTRACTOR'S PUMP KS37ZN UNIT (6000103)

Item	Article no.	Description	Quantity
R1	6016259	Rep.Kit 1 KS37,70+Z Vit	1
R2	6016303	Rep.Kit 2 KS37,70 +Z Vit	1
R3	6016304	Rep.Kit 3 KS37,70+Z Vit	1
R4	6016128	Screws KS37,70 + Z KIT	1
P	6042254	PAINT SPRAY Pantone334	1
P	6042255	colour 2K-paint IV80 pantone334C 250ml	1
P	6023614	Ceram C0 black 100 ml KIT	1
P	6020579	Ceram C0 black 250 ml KIT	1
P	6023485	Ceram C0 Black 500ml Kit	1
P	6019157	Ceram C0 black 1000 ml KIT	1
F1	6025461	medical white oil 5L KIT	1
F1	6025460	medical white oil 1L KIT	1
L1	6080531	Loctite 243 5g flask VP:	1
L1	2096167	Loctite 243 50ml VP.	1

C1		PLUG	1

1	6017708	pump shroud ZG4 51.1653 Al alternativ / alternative / alternative	1
1	6017707	pump shroud ZG4 51.1653 Al/C0	1
2		o-ring ID.270,0x3,0 Viton	1
3		o-ring ID.34,52x3,53 Viton	1
4		screw M10x140 DIN939 A2-70	4
5		Dubo-washer M10 NR.205 PA	4
6		nut M10 DIN934 A4-80 (20pc)	1
7	6001390	handle 52.1592 St vz KIT	1
7.1		> handle 52.1592 Stvz	1
7.2		> screw M10x20 DIN933 A4-70 alternativ / alternative / alternative	4
7.1	6016512	handle 52.1592 Stvz/C0	1
8	6013895	motor casing 50.1704 Al alternativ / alternative / alternative	1
8	6013894	motor casing 50.1704 Al/C0	1
9	6078160	o-ring ID.62,0x3,0 Viton (3pc)	1

CONTRACTOR'S PUMP KS37ZN UNIT (6000103)

Item	Article no.	Description	Quantity
10		nut M10 DIN934 A4-80 (20pc)	1
11		screw M10x120 A2	2
12		lock washer 10 DIN7980 A4 (10pc)	1
13	6001675	motor cover 52.1695 GG KIT	1
13.1		> motor cover D.126g6 52.1695 GG	1
13.2		> screw M8x20 ISO4762 A2-70	5
13.3		> o-ring ID.122,0x3,0 Viton	1
		alternativ / alternative / alternative	
13.1	6013978	motor cover D.126g6 52.1695 GG/C0	1
		Für Einschaltung Direkt	
		For direct-on-line starting	
		Pour démarrage direct	
14	6001886	cable gland 54.5696 GG KIT	1
14.1		> cable gland 54.5696 GG	1
14.2		> seal ring-profile 1646 Gi	1
14.3		> pressure ring 20,5 16 0,8 PG16 DIN46320	1
14.4		> o-ring ID.13,0x3,5 Viton	1
14.5	6003826	> cable protection 140x45 mm NR50° Shore	1
14.6		> screw M8x20 ISO4762 A2-70	2
15	6007632	cable NSSHÖU-J 4x1,5 round	
16	6001670	terminal board Melaminharz KIT	1
16.1		> terminal board Melaminharz	1
16.2		> duct bolt SW13x50 Ms	3
16.3		> pressure ring MS raw	3
16.4		> o-ring ID.5,0x2,0 NBR70	3
16.5		> washer A5,3 DIN125 A4	6
16.6		> lock washer 5 DIN7980 A4	9
16.7		> nut M5 DIN934 Ms	9
		Für Einschaltung Stern/Dreieck	
		For starting star-delta	
		Pour démarrage étoile-triangle	
14	6018980	cable gland 54. 5696 GG KIT	1
14.1		> cable gland 54.5696 GG	1
14.2		> seal ring-profile 5612 CR	1

CONTRACTOR'S PUMP KS37ZN UNIT (6000103)

Item	Article no.	Description	Quantity
14.3		> pressure ring 20,5 16 0,8 PG16 DIN46320	1
14.4		> o-ring ID.16,0x4,5 Viton	1
14.5	6003826	> cable protection 140x45 mm NR50° Shore	1
14.6		> screw M8x20 ISO4762 A2-70	2
15	6007534	cable NSSHÖU-J 7x1,5 round	
16	6024844	terminal board 53.11698 KIT	1
16.1		> terminal board Melaminharz	1
16.2		> duct bolt SW13x50 Ms	6
16.3		> pressure ring MS raw	6
16.4		> o-ring ID.5,0x2,0 NBR70	6
16.5		> washer A5,3 DIN125 A4	12
16.6		> lock washer 5 DIN7980 A4	18
16.7		> nut M5 DIN934 Ms	18

17		o-ring ID.65,0x3,0 Viton	1
18		screw M6x20 ISO4017 A2-70	3
19		screw M6x25 DIN939 A2-70	1
20		nut M6 DIN934 A4-80	2
21		lock washer 6 DIN7980 A4	1
22		washer A6,4 DIN125 A4	2
23		washer A6,4 DIN125 A4	3
24	6023486	stator F17-2/8 400/690 50Hz	1
		alternativ / alternative / alternative	
24	6023505	stator F17-2/8 230/400 50Hz	1
24	6023508	stator F17-2/8 500 50Hz VN01	1
25	6004661	circlips 174x2 54.1637 FSt	1
26	6035802	safety bar D.5x75 54.19444 St	1
27	6009995	rotor D.89x306 2/8 1.4021	1
29	6078164	ball bearing 6206 DDU C3 VP.	1
30	501355698	CIRCLIP 30X1,5 DIN471 FST	1
31	6001374	bearing housing U 51.1699 AI KIT	1
31.1		> bearing housing U 51.1699 AI	1
31.2	6067638	> screw plug G1/2 DIN908 A4 (3pcs)	1
31.3	6048832	> joint ring A21/26x1,5 DIN7603 PA(10pc)	1

CONTRACTOR'S PUMP KS37ZN UNIT (6000103)

Item	Article no.	Description	Quantity
31.4	6076642	> o-ring ID.203,0x3,0 Viton (3pc) alternativ / alternative / alternative	1
31.1	6013940	bearing housing U 51.1699 Al/C0	1
31.1	6019019	bearing housing U 51.1699 Al/C1	1
32	6008974	ball bearing 6306	1
30	501355698	CIRCLIP 30X1,5 DIN471 FST	1
33	6009373	pressure ring D.72/39,2x19,1 55.1689 GG	1
34		o-ring ID.65,0x3,0 Viton	1
35	6077844	mech.seal MG1/30-G60-E1AQ1PGG VP. alternativ / alternative / alternative	1
35	6074586	GRD. MG1/30-G4 Q1Q1VGG VP.	1
30	501355698	CIRCLIP 30X1,5 DIN471 FST	1
36	6074586	GRD. MG1/30-G4 Q1Q1VGG VP.	1
37	6002123	washer D.44/20x1 1.4301 -	1
38	6001372	sealing casing 52.1698/1 Al KIT	1
38.1		> sealing casing D.205g6 52.1698/1 Al	1
38.2	6076642	> o-ring ID.203,0x3,0 Viton (3pc) alternativ / alternative / alternative	1
38.1	6013727	sealing casing D.205 52.1698/1 Al/C0	1
39	6075378	wear plate 53.1693 Neoprene VP. Lauftrad / Impeller / Roue 50Hz	1
40	6014043	impeller-M D.137 53.1029 GGG alternativ / alternative / alternative	1
40	6021691	impeller-M D.137 53.1029 GGG/C0	1
40	6010631	impeller-M D.137 53.17903 Abrasit	1
40	6024254	impeller-M D.137 53.17903 Abrasit/CO	1
40	6021642	impeller-M D.137 53.1029 1.4581 Lauftrad / Impeller / Roue 60Hz	1
40	6022872	impeller-M D.124 53.1029 GGG alternativ / alternative / alternative	1
40	6022874	impeller-M D.124 53.1029 GGG/C0	1
40	6022773	impeller-M D.124 53.17903 Abrasit	1
40	6024256	impeller-M D.124 53.17903 Abrasit/CO	1
40	6022873	impeller-M D.124 53.1029 1.4581	1

CONTRACTOR'S PUMP KS37ZN UNIT (6000103)

Item	Article no.	Description	Quantity
41	6043597	impeller fixation 55.5399/1 1.4021 KIT	1
41.1		> washer D.26/9x13 55.5399/1	1
41.2	6003416	> screw M8x25 DIN912 10.9 Geomet	1
41.3	6002688	> screw locking Nord-Lock 13,5/8,7 A4	1
41.4	6004654	> key A 6x4x18 54.2589 A4	1
44	6001370	pump housing A 51.1702 GG KIT	1
44.1		> pump housing A 51.1702 GG	1
44.2		> o-ring ID.270,0x3,0 Viton	1
44.1.1	6073152	neck ring D.105x13 6051846 1.4470 VP. alternativ / alternative / alternative	1
44.1	6012861	pump housing A 51.1702 GG/C0	1
44.1	6012830	pump housing A 51.1702 GG/C1C1	1
44.1	6012845	pump housing A 51.1702 GG/C2C1	1
44.1	6012909	pump housing A 51.16785 1.4581	1
44.1	6022771	pump housing A 51.19190 Abrasit	1
44.1	6022779	pump housing A 53.19190 Abrasit/C0	1
45	6001371	strainer 53.17962 1.4301 KIT	1
45.1		> strainer 57x273x2 53.17962 1.4301	1
45.2		> base plate D.284 52.17961 Al	1
45.3		> screw M10x35 DIN933 A2-70	4
		alternativ / alternative / alternative	
45.1	6013069	strainer 57x273x2 53.17962 1.4301/CO	1

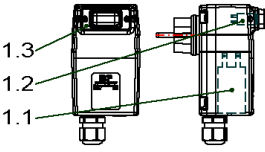
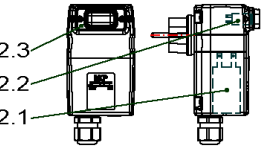
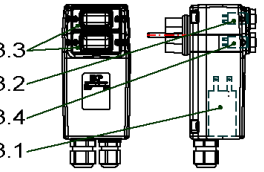
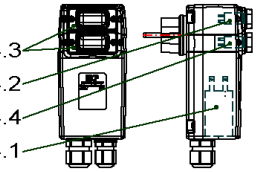
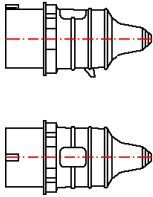
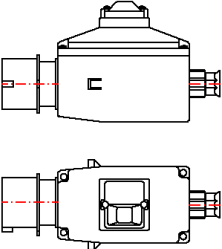
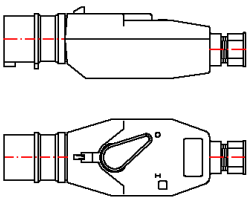
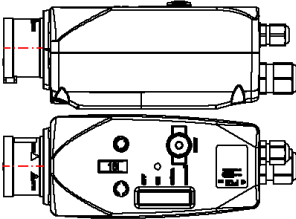
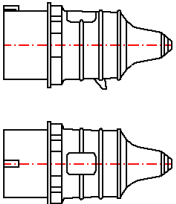
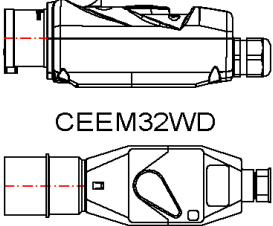
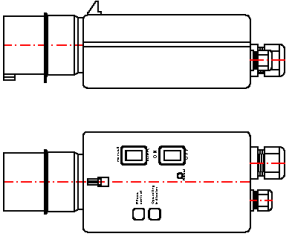
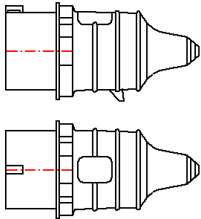
<p>1 MCP 6A-M-H-20μF ~ 230V</p>  <p>$I_N(230V / 50Hz) < 6A = 20\mu F$</p>	<p>2 MCP 10A-M-H-30μF ~ 230V</p>  <p>$I_N(230V / 50Hz) 6-10A = 30\mu F$</p>	<p>3 MCP 6A-M-HA-20μF ~ 230V</p>  <p>$I_N(230V / 50Hz) < 6A = 20\mu F$</p>	<p>4 MCP 10A-M-HA-30μF ~ 230V</p>  <p>$I_N(230V / 50Hz) 6-10A = 30\mu F$</p>
<p>5 CEE16A</p> 	<p>6 CEEM16W</p> 	<p>7 CEEM16WD</p> 	<p>8 MCP T4-HA-ROT-WSK CEE16-5PS</p> 
<p>9 CEE32A</p> 	<p>10 MCP 10-16A-T4-H-ROT CEE32-5PS</p>  <p>CEEM32WD</p>	<p>11 CEEM32WDSHA</p> 	<p>12 CEE63A</p> 

PLUG

Item	Article no.	Description	Quantity
		IN (230V / 50Hz) <6A - 20μF	
1	6072332	MCP 6A-M-H-20μF-CEE7/7 VP.	1
1.1	6071702	capacitor 400V 20μF MCP VP.	1
1.2	6071704	protection switch 6A MCP VP.	1
1.3	6071707	protecting cap MCP VP.	1
		IN (230V / 50Hz) 6-10A - 30μF	
2	6072330	MCP 10A-M-H-30μF-CEE7/7 VP.	1
2.1	6071703	capacitor 400V 30μF MCP VP.	1
2.2	6071705	protection switch 10A MCP VP.	1
2.3	6071707	protecting cap MCP VP.	1
		IN (230V / 50Hz) <6A - 20μF	
3	6072331	MCP 6A-M-HA-20μF-CEE7/7 VP.	1
3.1	6071702	capacitor 400V 20μF MCP VP.	1
3.2	6071704	protection switch 6A MCP VP.	1
3.3	6071707	protecting cap MCP VP.	2
3.4	6071706	switch on/out MCP VP.	1
		IN (230V / 50Hz) 6-10A - 30μF	
4	6072329	MCP 10A-M-HA-30μF-CEE7/7 VP	1
4.1	6071703	capacitor 400V 30μF MCP VP.	1
4.2	6071705	protection switch 10A MCP VP.	1
4.3	6071707	protecting cap MCP VP.	2
4.4	6071706	switch on/out MCP VP.	1
5	6003000	plug CEE16A/400V 60Hz/5P-11h	1
5	6003248	plug CEE16A/400V/4P-6H	1
5	6003009	plug CEE16A/400V/5P-6H	1
5	6039156	plug CEE16A/400V/5P-6H Phase inverter	1
5	6035231	plug CEE16A/400V/7P-6H	1
5	6003011	plug CEE16A/500V/5P-7H	1
6	6030883	plug MS400V5P CEE16A W 1,0-1,6A	1
6	6030884	plug MS400V5P CEE16A W 1,6-2,5A	1
6	6030888	plug MS400V5P CEE16A W 10,0-16,0A	1
6	6030885	plug MS400V5P CEE16A W 2,5-4,0A	1
6	6030886	plug MS400V5P CEE16A W 4,0-6,3A	1
6	6030887	plug MS400V5P CEE16A W 6,3-10,0A	1

PLUG

Item	Article no.	Description	Quantity
7	6032446	plug MS400V4P CEE16A WD 1,6-2,5A	1
7	6032447	plug MS400V4P CEE16A WD 12,5-16,0A	1
7	6032295	plug MS400V4P CEE16A WD 2,5-4,0A	1
7	6032289	plug MS400V4P CEE16A WD 4,0-6,3A	1
7	6032292	plug MS400V4P CEE16A WD 6,3-9,0A	1
7	6042190	plug MS400V5P CEE16A WDII 1,6-2,5A	1
7	6042194	plug MS400V5P CEE16A WDII 10,0-16,0A	1
7	6042191	plug MS400V5P CEE16A WDII 2,5-4,0A	1
7	6042192	plug MS400V5P CEE16A WDII 4,0-6,3A	1
7	6042193	plug MS400V5P CEE16A WDII 6,3-10,0A	1
7	6035911	plug MS400V5P CEE16A WD 9,0-12,5A	1
7	6003337	plug MS500V5P CEE16A WD 1,6-2,5A	1
7	6003336	plug MS500V5P CEE16A WD 2,5-4,0A	1
7	6003335	plug MS500V5P CEE16A WD 4,0-6,3A	1
7	6003334	plug MS500V5P CEE16A WD 6,3-9,0A	1
8	6072520	MCP 1,0-1,6A-T4-HA-ROT-WSK-CEE16-5PS VP.	1
8	6072521	MCP 1,6-2,4A-T4-HA-ROT-WSK-CEE16-5PS VP.	1
8	6072522	MCP 2,4-4,0A-T4-HA-ROT-WSK-CEE16-5PS VP.	1
8	6072523	MCP 4,0-6,0A-T4-HA-ROT-WSK-CEE16-5PS VP.	1
8	6072524	MCP 6,0-10A-T4-HA-ROT-WSK-CEE16-5PS VP.	1
8	6072525	MCP 9,0-12A-T4-HA-ROT-WSK-CEE16-5PS VP.	1
8	6072526	MCP 12-16A-T4-HA-ROT-WSK-CEE16-5PS VP.	1
9	6003267	plug CEE32A/400V/4P-6H	1
9	6039155	plug CEE32A/400V/5P-6H Phase inverter	1
9	6035895	plug CEE32A/500V/4P-7H AM-Top	1
9	6003010	plug CEE32A/500V/5P-7H	1
10	6072370	MCP 400V 1,6-2,5A-T4-H-ROT-CEE32-5PS VP.	1
10	6072369	MCP 400V 2,5-4,0A-T4-H-ROT-CEE32-5PS VP.	1
10	6072371	MCP 400V 4,0-6,3A-T4-H-ROT-CEE32-5PS VP.	1
10	6072398	MCP 400V 6,3-10A-T4-H-ROT-CEE32-5PS VP.	1
10	6072519	MCP 400V 10-16A-T4-H-ROT-CEE32-5PS VP.	1
10	6072399	MCP 400V 16-20A-T4-H-ROT-CEE32-5PS VP.	1
10	6072518	MCP 400V 20-25A-T4-H-ROT-CEE32-5PS VP.	1
10	6037649	plug.MS500V4P CEE32A WD 2,5-4,0A	1

PLUG

Item	Article no.	Description	Quantity
10	6041268	plug MS500V4P CEE32A WD 4,0-6,3A	1
10	6035244	plug MS500V5P CEE32A WD 1,6-2,5A	1
10	6034700	plug MS500V5P CEE32A WD 2,5-4,0A	1
10	6041556	plug MS500V5P CEE32A WD 4,0-6,3A	1
10	6002701	plug MS500V5P CEE32A WD 9,0-12,5A	1
10	6002700	plug MS500V5P CEE32A WD 12,5-16,0A	1
11	6003241	plug MS400V5P CEE32A WDSHA 10,0-14,0A	1
11	6003266	plug MS400V5P CEE32A WDSHA 3,7-5,5A	1
11	6003265	plug MS400V5P CEE32A WDSHA 5,5-8,0A	1
11	6003264	plug MS400V5P CEE32A WDSHA 8,0-11,5A	1
12	6003012	plug CEE63A/400V/5P-6H/IP67	1

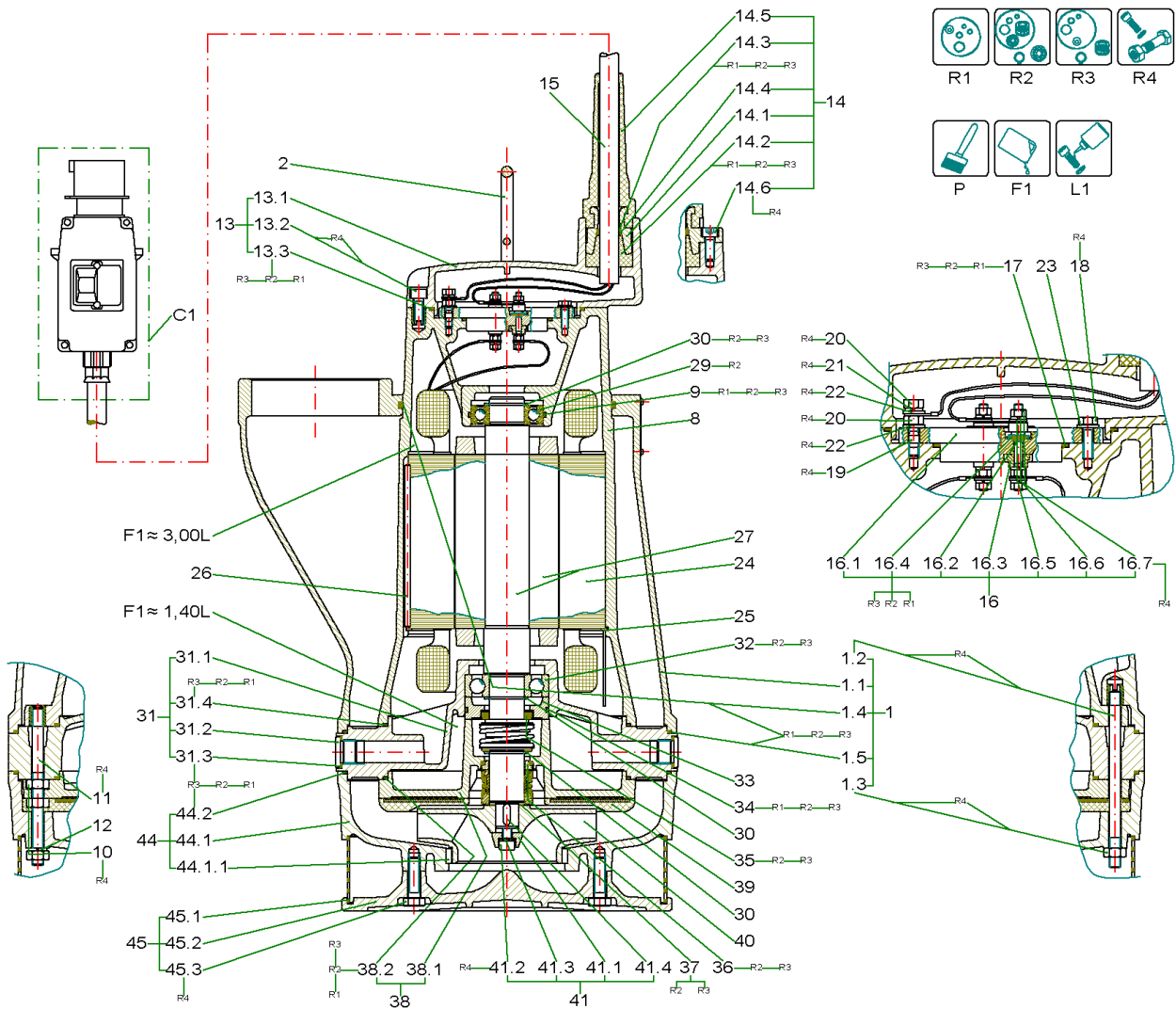

CONTRACTOR'S PUMP KS70H UNIT (6000106)

Item	Article no.	Description	Quantity
R1	6016259	Rep.Kit 1 KS37,70+Z Vit	1
R2	6016303	Rep.Kit 2 KS37,70 +Z Vit	1
R3	6016304	Rep.Kit 3 KS37,70+Z Vit	1
R4	6016128	Screws KS37,70 + Z KIT	1
P	6042254	PAINT SPRAY Pantone334	1
P	6042255	colour 2K-paint IV80 pantone334C 250ml	1
P	6023614	Ceram C0 black 100 ml KIT	1
P	6020579	Ceram C0 black 250 ml KIT	1
P	6023485	Ceram C0 Black 500ml Kit	1
P	6019157	Ceram C0 black 1000 ml KIT	1
F1	6025461	medical white oil 5L KIT	1
F1	6025460	medical white oil 1L KIT	1
L1	6080531	Loctite 243 5g flask VP:	1
L1	2096167	Loctite 243 50ml VP.	1

C1		PLUG	1

1		pump shroud SG4 1694 Al KIT	1
Note: nicht mehr lieferbar / no longer available / ne plus disponible			
1	6049611	pump shroud conversion KS70-KS70Z KIT	1
Note: Ersatz / replacement / remplacement			
2	6016511	handle 54.1649/1 A2	1
8		motor casing 51.1696 Al	1
8		No longer available	1
9	6078160	o-ring ID.62,0x3,0 Viton (3pc)	1
10		nut M10 DIN934 A4-80	6
11		screw M10x120 A2	2
12		lock washer 10 DIN7980 A4 (10pc)	1
13	6001675	motor cover 52.1695 GG KIT	1
13.1		> motor cover D.126g6 52.1695 GG	1
13.2		> screw M8x20 ISO4762 A2-70	5
13.3		> o-ring ID.122,0x3,0 Viton	1
alternativ / alternative / alternative			
13.1	6013978	motor cover D.126g6 52.1695 GG/C0	1

CONTRACTOR'S PUMP KS70H UNIT (6000106)

Item	Article no.	Description	Quantity
14	6018980	cable gland 54. 5696 GG KIT	1
14.1		> cable gland 54.5696 GG	1
14.2		> seal ring-profile 5612 CR	1
14.3		> pressure ring 20,5 16 0,8 PG16 DIN46320	1
14.4		> o-ring ID.16,0x4,5 Viton	1
14.5	6003826	> cable protection 140x45 mm NR50° Shore	1
14.6		> screw M8x20 ISO4762 A2-70	2
		Für Einschaltung Direkt	
		For direct-on-line starting	
		Pour démarrage direct	
15	6007639	cable NSSHÖU-J 4x2,5 round	
16	6001670	terminal board Melaminharz KIT	1
16.1		> terminal board Melaminharz	1
16.2		> duct bolt SW13x50 Ms	3
16.3		> pressure ring MS raw	3
16.4		> o-ring ID.5,0x2,0 NBR70	3
16.5		> washer A5,3 DIN125 A4	6
16.6		> lock washer 5 DIN7980 A4	9
16.7		> nut M5 DIN934 Ms	9
		Für Einschaltung Stern/Dreieck	
		For starting star-delta	
		Pour démarrage étoile-triangle	
15	6007534	cable NSSHÖU-J 7x1,5 round	
16	6024844	terminal board 53.11698 KIT	1
16.1		> terminal board Melaminharz	1
16.2		> duct bolt SW13x50 Ms	6
16.3		> pressure ring MS raw	6
16.4		> o-ring ID.5,0x2,0 NBR70	6
16.5		> washer A5,3 DIN125 A4	12
16.6		> lock washer 5 DIN7980 A4	18
16.7		> nut M5 DIN934 Ms	18

17		o-ring ID.65,0x3,0 Viton	1
18		screw M6x20 ISO4017 A2-70	3

CONTRACTOR'S PUMP KS70H UNIT (6000106)

Item	Article no.	Description	Quantity
19		screw M6x25 DIN939 A2-70	1
20		nut M6 DIN934 A4-80	2
21		lock washer 6 DIN7980 A4	1
22		washer A6,4 DIN125 A4	2
23		washer A6,4 DIN125 A4	3
24	6023487	stator F17-2/15 400/690 50Hz	1
		alternativ / alternative / alternative	
24	6023506	stator F17-2/15 230 50Hz	1
24	6023509	stator F17-2/15 500 50Hz VN01	1
25	6004661	circlips 174x2 54.1637 FSt	1
26	6035808	safety bar D.5x140 54.19444 St	1
27	6009989	rotor D.89,3x371 2/15 1.4021	1
29	6078164	ball bearing 6206 DDU C3 VP.	1
30	501355698	CIRCLIP 30X1,5 DIN471 FST	1
31	6001374	bearing housing U 51.1699 Al KIT	1
31.1		> bearing housing U 51.1699 Al	1
31.2	6067638	> screw plug G1/2 DIN908 A4 (3pcs)	1
31.3	6048832	> joint ring A21/26x1,5 DIN7603 PA(10pc)	1
31.4	6076642	> o-ring ID.203,0x3,0 Viton (3pc)	1
		alternativ / alternative / alternative	
31.1	6013940	bearing housing U 51.1699 Al/C0	1
31.1	6019019	bearing housing U 51.1699 Al/C1	1
32	6008974	ball bearing 6306	1
30	501355698	CIRCLIP 30X1,5 DIN471 FST	1
33	6009373	pressure ring D.72/39,2x19,1 55.1689 GG	1
34		o-ring ID.65,0x3,0 Viton	1
35	6077844	mech.seal MG1/30-G60-E1AQ1PGG VP.	1
		alternativ / alternative / alternative	
35	6074586	GRD. MG1/30-G4 Q1Q1VGG VP.	1
30	501355698	CIRCLIP 30X1,5 DIN471 FST	1
36	6074586	GRD. MG1/30-G4 Q1Q1VGG VP.	1
37	6002123	washer D.44/20x1 1.4301 -	1
38	6001372	sealing casing 52.1698/1 Al KIT	1
38.1		> sealing casing D.205g6 52.1698/1 Al	1

CONTRACTOR'S PUMP KS70H UNIT (6000106)

Item	Article no.	Description	Quantity
38.2	6076642	> o-ring ID.203,0x3,0 Viton (3pc) alternativ / alternative / alternative	1
38.1	6013727	sealing casing D.205 52.1698/1 Al/C0	1
39	6075378	wear plate 53.1693 Neoprene VP. Laufrad / Impeller / Roue 50Hz	1
40	6014063	impeller-M D.199 53.1378 GGG alternativ / alternative / alternative	1
40	6014061	impeller-M D.199 53.1378 GGG/C0 Laufrad / Impeller / Roue 60Hz	1
40	6014059	impeller-M D.182 53.1126 GGG alternativ / alternative / alternative	1
40	6021692	impeller-M D.182 53.1126 GGG/C0	1
41	6043597	impeller fixation 55.5399/1 1.4021 KIT	1
41.1		> washer D.26/9x13 55.5399/1	1
41.2	6003416	> screw M8x25 DIN912 10.9 Geomet	1
41.3	6002688	> screw locking Nord-Lock 13,5/8,7 A4	1
41.4	6004654	> key A 6x4x18 54.2589 A4	1
44	6001370	pump housing A 51.1702 GG KIT	1
44.1		> pump housing A 51.1702 GG	1
44.2		> o-ring ID.270,0x3,0 Viton	1
44.1.1	6073152	neck ring D.105x13 6051846 1.4470 VP. alternativ / alternative / alternative	1
44.1	6012861	pump housing A 51.1702 GG/C0	1
44.1	6012830	pump housing A 51.1702 GG/C1C1	1
44.1	6012845	pump housing A 51.1702 GG/C2C1	1
44.1	6012909	pump housing A 51.16785 1.4581	1
44.1	6022771	pump housing A 51.19190 Abrasit	1
44.1	6022779	pump housing A 53.19190 Abrasit/C0	1
45	6001371	strainer 53.17962 1.4301 KIT	1
45.1		> strainer 57x273x2 53.17962 1.4301	1
45.2		> base plate D.284 52.17961 Al	1
45.3		> screw M10x35 DIN933 A2-70 alternativ / alternative / alternative	4
45.1	6013069	strainer 57x273x2 53.17962 1.4301/CO	1

CONTRACTOR'S PUMP KS70H UNIT (6000106)

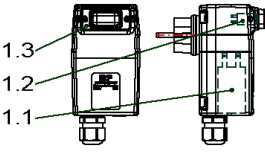
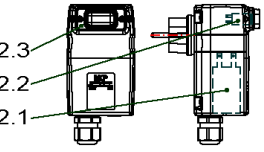
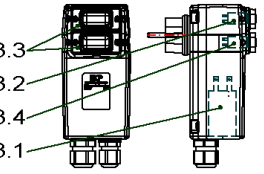
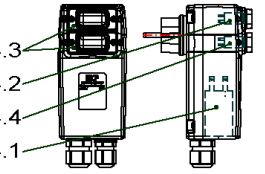
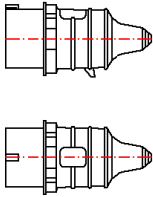
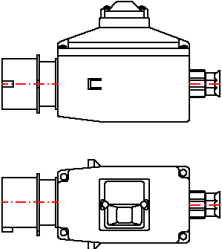
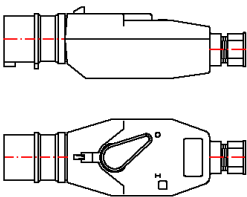
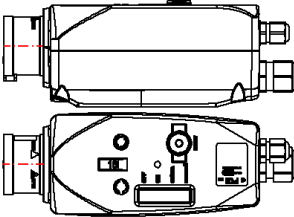
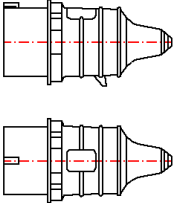
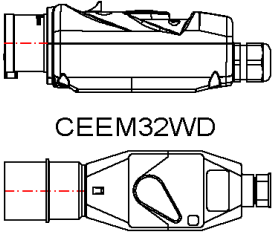
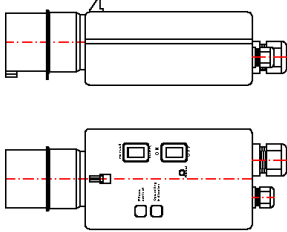
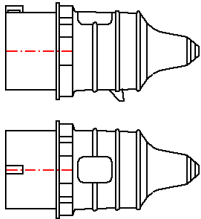

Item	Article no.	Description	Quantity
		Dubo-washer M10 NR.205 PA	4

<p>1 MCP 6A-M-H-20μF ~ 230V</p>  <p>$I_N(230V / 50Hz) < 6A = 20\mu F$</p>	<p>2 MCP 10A-M-H-30μF ~ 230V</p>  <p>$I_N(230V / 50Hz) 6-10A = 30\mu F$</p>	<p>3 MCP 6A-M-HA-20μF ~ 230V</p>  <p>$I_N(230V / 50Hz) < 6A = 20\mu F$</p>	<p>4 MCP 10A-M-HA-30μF ~ 230V</p>  <p>$I_N(230V / 50Hz) 6-10A = 30\mu F$</p>
<p>5 CEE16A</p> 	<p>6 CEEM16W</p> 	<p>7 CEEM16WD</p> 	<p>8 MCP T4-HA-ROT-WSK CEE16-5PS</p> 
<p>9 CEE32A</p> 	<p>10 MCP 10-16A-T4-H-ROT CEE32-5PS</p>  <p>CEEM32WD</p>	<p>11 CEEM32WDSHA</p> 	<p>12 CEE63A</p> 

PLUG

Item	Article no.	Description	Quantity
		IN (230V / 50Hz) <6A - 20μF	
1	6072332	MCP 6A-M-H-20μF-CEE7/7 VP.	1
1.1	6071702	capacitor 400V 20μF MCP VP.	1
1.2	6071704	protection switch 6A MCP VP.	1
1.3	6071707	protecting cap MCP VP.	1
		IN (230V / 50Hz) 6-10A - 30μF	
2	6072330	MCP 10A-M-H-30μF-CEE7/7 VP.	1
2.1	6071703	capacitor 400V 30μF MCP VP.	1
2.2	6071705	protection switch 10A MCP VP.	1
2.3	6071707	protecting cap MCP VP.	1
		IN (230V / 50Hz) <6A - 20μF	
3	6072331	MCP 6A-M-HA-20μF-CEE7/7 VP.	1
3.1	6071702	capacitor 400V 20μF MCP VP.	1
3.2	6071704	protection switch 6A MCP VP.	1
3.3	6071707	protecting cap MCP VP.	2
3.4	6071706	switch on/out MCP VP.	1
		IN (230V / 50Hz) 6-10A - 30μF	
4	6072329	MCP 10A-M-HA-30μF-CEE7/7 VP	1
4.1	6071703	capacitor 400V 30μF MCP VP.	1
4.2	6071705	protection switch 10A MCP VP.	1
4.3	6071707	protecting cap MCP VP.	2
4.4	6071706	switch on/out MCP VP.	1
5	6003000	plug CEE16A/400V 60Hz/5P-11h	1
5	6003248	plug CEE16A/400V/4P-6H	1
5	6003009	plug CEE16A/400V/5P-6H	1
5	6039156	plug CEE16A/400V/5P-6H Phase inverter	1
5	6035231	plug CEE16A/400V/7P-6H	1
5	6003011	plug CEE16A/500V/5P-7H	1
6	6030883	plug MS400V5P CEE16A W 1,0-1,6A	1
6	6030884	plug MS400V5P CEE16A W 1,6-2,5A	1
6	6030888	plug MS400V5P CEE16A W 10,0-16,0A	1
6	6030885	plug MS400V5P CEE16A W 2,5-4,0A	1
6	6030886	plug MS400V5P CEE16A W 4,0-6,3A	1
6	6030887	plug MS400V5P CEE16A W 6,3-10,0A	1

PLUG

Item	Article no.	Description	Quantity
7	6032446	plug MS400V4P CEE16A WD 1,6-2,5A	1
7	6032447	plug MS400V4P CEE16A WD 12,5-16,0A	1
7	6032295	plug MS400V4P CEE16A WD 2,5-4,0A	1
7	6032289	plug MS400V4P CEE16A WD 4,0-6,3A	1
7	6032292	plug MS400V4P CEE16A WD 6,3-9,0A	1
7	6042190	plug MS400V5P CEE16A WDII 1,6-2,5A	1
7	6042194	plug MS400V5P CEE16A WDII 10,0-16,0A	1
7	6042191	plug MS400V5P CEE16A WDII 2,5-4,0A	1
7	6042192	plug MS400V5P CEE16A WDII 4,0-6,3A	1
7	6042193	plug MS400V5P CEE16A WDII 6,3-10,0A	1
7	6035911	plug MS400V5P CEE16A WD 9,0-12,5A	1
7	6003337	plug MS500V5P CEE16A WD 1,6-2,5A	1
7	6003336	plug MS500V5P CEE16A WD 2,5-4,0A	1
7	6003335	plug MS500V5P CEE16A WD 4,0-6,3A	1
7	6003334	plug MS500V5P CEE16A WD 6,3-9,0A	1
8	6072520	MCP 1,0-1,6A-T4-HA-ROT-WSK-CEE16-5PS VP.	1
8	6072521	MCP 1,6-2,4A-T4-HA-ROT-WSK-CEE16-5PS VP.	1
8	6072522	MCP 2,4-4,0A-T4-HA-ROT-WSK-CEE16-5PS VP.	1
8	6072523	MCP 4,0-6,0A-T4-HA-ROT-WSK-CEE16-5PS VP.	1
8	6072524	MCP 6,0-10A-T4-HA-ROT-WSK-CEE16-5PS VP.	1
8	6072525	MCP 9,0-12A-T4-HA-ROT-WSK-CEE16-5PS VP.	1
8	6072526	MCP 12-16A-T4-HA-ROT-WSK-CEE16-5PS VP.	1
9	6003267	plug CEE32A/400V/4P-6H	1
9	6039155	plug CEE32A/400V/5P-6H Phase inverter	1
9	6035895	plug CEE32A/500V/4P-7H AM-Top	1
9	6003010	plug CEE32A/500V/5P-7H	1
10	6072370	MCP 400V 1,6-2,5A-T4-H-ROT-CEE32-5PS VP.	1
10	6072369	MCP 400V 2,5-4,0A-T4-H-ROT-CEE32-5PS VP.	1
10	6072371	MCP 400V 4,0-6,3A-T4-H-ROT-CEE32-5PS VP.	1
10	6072398	MCP 400V 6,3-10A-T4-H-ROT-CEE32-5PS VP.	1
10	6072519	MCP 400V 10-16A-T4-H-ROT-CEE32-5PS VP.	1
10	6072399	MCP 400V 16-20A-T4-H-ROT-CEE32-5PS VP.	1
10	6072518	MCP 400V 20-25A-T4-H-ROT-CEE32-5PS VP.	1
10	6037649	plug.MS500V4P CEE32A WD 2,5-4,0A	1

PLUG

Item	Article no.	Description	Quantity
10	6041268	plug MS500V4P CEE32A WD 4,0-6,3A	1
10	6035244	plug MS500V5P CEE32A WD 1,6-2,5A	1
10	6034700	plug MS500V5P CEE32A WD 2,5-4,0A	1
10	6041556	plug MS500V5P CEE32A WD 4,0-6,3A	1
10	6002701	plug MS500V5P CEE32A WD 9,0-12,5A	1
10	6002700	plug MS500V5P CEE32A WD 12,5-16,0A	1
11	6003241	plug MS400V5P CEE32A WDSHA 10,0-14,0A	1
11	6003266	plug MS400V5P CEE32A WDSHA 3,7-5,5A	1
11	6003265	plug MS400V5P CEE32A WDSHA 5,5-8,0A	1
11	6003264	plug MS400V5P CEE32A WDSHA 8,0-11,5A	1
12	6003012	plug CEE63A/400V/5P-6H/IP67	1

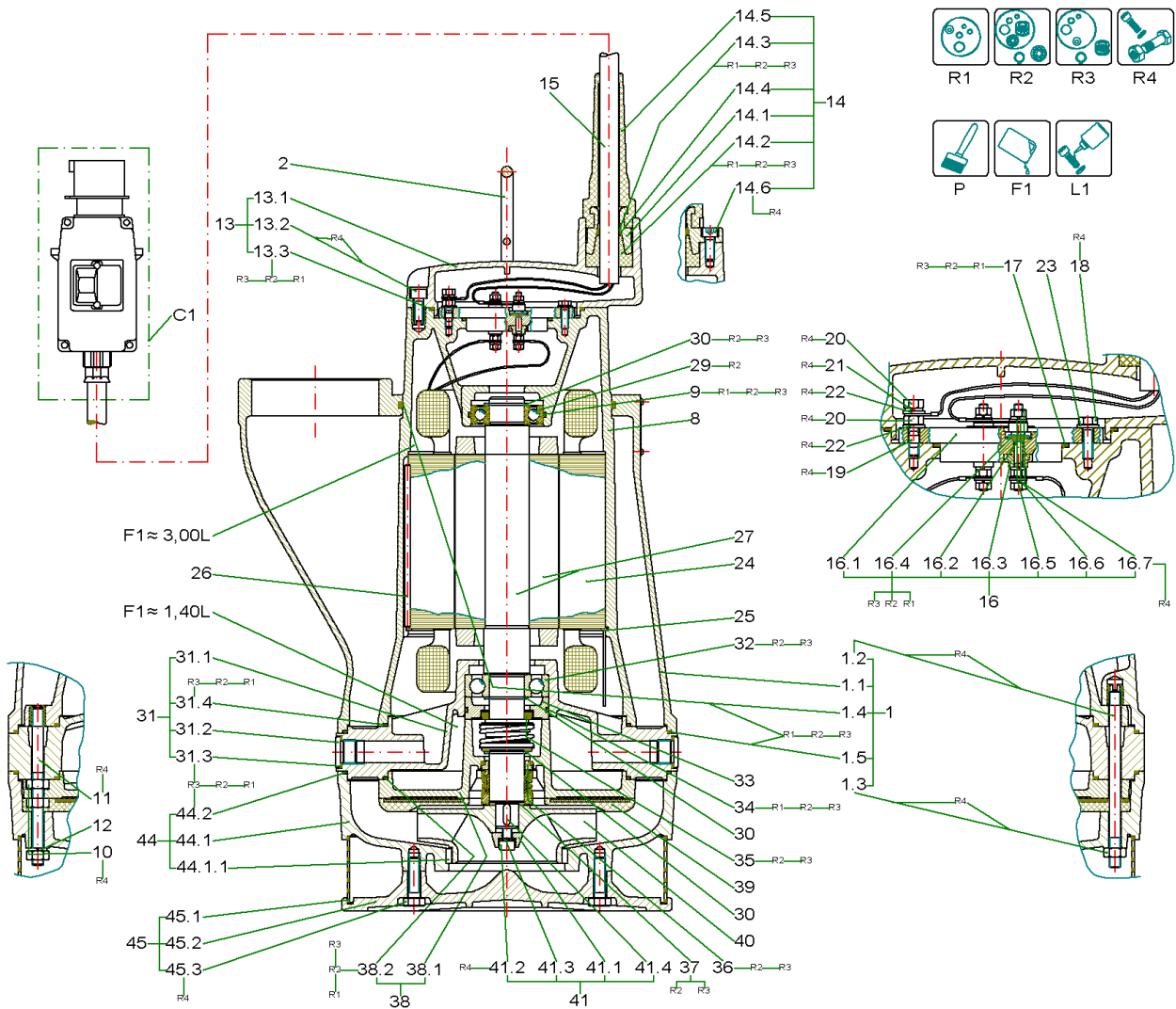

CONTRACTOR'S PUMP KS70M UNIT (6000107)

Item	Article no.	Description	Quantity
R1	6016259	Rep.Kit 1 KS37,70+Z Vit	1
R2	6016303	Rep.Kit 2 KS37,70 +Z Vit	1
R3	6016304	Rep.Kit 3 KS37,70+Z Vit	1
R4	6016128	Screws KS37,70 + Z KIT	1
P	6042254	PAINT SPRAY Pantone334	1
P	6042255	colour 2K-paint IV80 pantone334C 250ml	1
P	6023614	Ceram C0 black 100 ml KIT	1
P	6020579	Ceram C0 black 250 ml KIT	1
P	6023485	Ceram C0 Black 500ml Kit	1
P	6019157	Ceram C0 black 1000 ml KIT	1
F1	6025461	medical white oil 5L KIT	1
F1	6025460	medical white oil 1L KIT	1
L1	6080531	Loctite 243 5g flask VP:	1
L1	2096167	Loctite 243 50ml VP.	1

C1		PLUG	1

1		pump shroud SG4 1694 Al KIT	1
Note: nicht mehr lieferbar / no longer available / ne plus disponible			
1	6049611	pump shroud conversion KS70-KS70Z KIT	1
Note: Ersatz / replacement / remplacement			
2	6016511	handle 54.1649/1 A2	1
8		motor casing 51.1696 Al	1
8		No longer available	1
9	6078160	o-ring ID.62,0x3,0 Viton (3pc)	1
10		nut M10 DIN934 A4-80	6
11		screw M10x120 A2	2
12		lock washer 10 DIN7980 A4 (10pc)	1
13	6001675	motor cover 52.1695 GG KIT	1
13.1		> motor cover D.126g6 52.1695 GG	1
13.2		> screw M8x20 ISO4762 A2-70	5
13.3		> o-ring ID.122,0x3,0 Viton	1
		alternativ / alternative / alternative	
13.1	6013978	motor cover D.126g6 52.1695 GG/C0	1

CONTRACTOR'S PUMP KS70M UNIT (6000107)

Item	Article no.	Description	Quantity
14	6018980	cable gland 54. 5696 GG KIT	1
14.1		> cable gland 54.5696 GG	1
14.2		> seal ring-profile 5612 CR	1
14.3		> pressure ring 20,5 16 0,8 PG16 DIN46320	1
14.4		> o-ring ID.16,0x4,5 Viton	1
14.5	6003826	> cable protection 140x45 mm NR50° Shore	1
14.6		> screw M8x20 ISO4762 A2-70	2
		Für Einschaltung Direkt	
		For direct-on-line starting	
		Pour démarrage direct	
15	6007639	cable NSSHÖU-J 4x2,5 round	
16	6001670	terminal board Melaminharz KIT	1
16.1		> terminal board Melaminharz	1
16.2		> duct bolt SW13x50 Ms	3
16.3		> pressure ring MS raw	3
16.4		> o-ring ID.5,0x2,0 NBR70	3
16.5		> washer A5,3 DIN125 A4	6
16.6		> lock washer 5 DIN7980 A4	9
16.7		> nut M5 DIN934 Ms	9
		Für Einschaltung Stern/Dreieck	
		For starting star-delta	
		Pour démarrage étoile-triangle	
15	6007534	cable NSSHÖU-J 7x1,5 round	
16	6024844	terminal board 53.11698 KIT	1
16.1		> terminal board Melaminharz	1
16.2		> duct bolt SW13x50 Ms	6
16.3		> pressure ring MS raw	6
16.4		> o-ring ID.5,0x2,0 NBR70	6
16.5		> washer A5,3 DIN125 A4	12
16.6		> lock washer 5 DIN7980 A4	18
16.7		> nut M5 DIN934 Ms	18

17		o-ring ID.65,0x3,0 Viton	1
18		screw M6x20 ISO4017 A2-70	3

CONTRACTOR'S PUMP KS70M UNIT (6000107)

Item	Article no.	Description	Quantity
19		screw M6x25 DIN939 A2-70	1
20		nut M6 DIN934 A4-80	2
21		lock washer 6 DIN7980 A4	1
22		washer A6,4 DIN125 A4	2
23		washer A6,4 DIN125 A4	3
24	6023487	stator F17-2/15 400/690 50Hz	1
		alternativ / alternative / alternative	
24	6023506	stator F17-2/15 230 50Hz	1
24	6023509	stator F17-2/15 500 50Hz VN01	1
25	6004661	circlips 174x2 54.1637 FSt	1
26	6035808	safety bar D.5x140 54.19444 St	1
27	6009989	rotor D.89,3x371 2/15 1.4021	1
29	6078164	ball bearing 6206 DDU C3 VP.	1
30	501355698	CIRCLIP 30X1,5 DIN471 FST	1
31	6001374	bearing housing U 51.1699 Al KIT	1
31.1		> bearing housing U 51.1699 Al	1
31.2	6067638	> screw plug G1/2 DIN908 A4 (3pcs)	1
31.3	6048832	> joint ring A21/26x1,5 DIN7603 PA(10pc)	1
31.4	6076642	> o-ring ID.203,0x3,0 Viton (3pc)	1
		alternativ / alternative / alternative	
31.1	6013940	bearing housing U 51.1699 Al/C0	1
31.1	6019019	bearing housing U 51.1699 Al/C1	1
32	6008974	ball bearing 6306	1
30	501355698	CIRCLIP 30X1,5 DIN471 FST	1
33	6009373	pressure ring D.72/39,2x19,1 55.1689 GG	1
34		o-ring ID.65,0x3,0 Viton	1
35	6077844	mech.seal MG1/30-G60-E1AQ1PGG VP.	1
		alternativ / alternative / alternative	
35	6074586	GRD. MG1/30-G4 Q1Q1VGG VP.	1
30	501355698	CIRCLIP 30X1,5 DIN471 FST	1
36	6074586	GRD. MG1/30-G4 Q1Q1VGG VP.	1
37	6002123	washer D.44/20x1 1.4301 -	1
38	6001372	sealing casing 52.1698/1 Al KIT	1
38.1		> sealing casing D.205g6 52.1698/1 Al	1

CONTRACTOR'S PUMP KS70M UNIT (6000107)

Item	Article no.	Description	Quantity
38.2	6076642	> o-ring ID.203,0x3,0 Viton (3pc) alternativ / alternative / alternative	1
38.1	6013727	sealing casing D.205 52.1698/1 Al/C0	1
39	6075378	wear plate 53.1693 Neoprene VP. Laufrad / Impeller / Roue 50Hz	1
40	6014077	impeller-M D.182 53.1364 GGG alternativ / alternative / alternative	1
40	6014064	impeller-M D.182 53.1364 GGG/C0	1
40	6010624	impeller-M D.182 53.17905 Abrasit	1
40	6022783	impeller-M D.182 53.17905 Abrasit/CO	1
40	6014076	impeller-M D.182 53.1364 1.4581 Laufrad / Impeller / Roue 60Hz	1
40	6014075	impeller-M D.160 53.1127 GGG alternativ / alternative / alternative	1
40	6021694	impeller-M D.160 53.1127 GGG/C0	1
40	6024440	impeller-M D.160 53.17905 Abrasit	1
40	6022782	impeller-M D.160 53.17905 Abrasit/CO	1
40	6021644	impeller-M D.160 53.1127 1.4581	1
41	6043597	impeller fixation 55.5399/1 1.4021 KIT	1
41.1		> washer D.26/9x13 55.5399/1	1
41.2	6003416	> screw M8x25 DIN912 10.9 Geomet	1
41.3	6002688	> screw locking Nord-Lock 13,5/8,7 A4	1
41.4	6004654	> key A 6x4x18 54.2589 A4	1
44	6001370	pump housing A 51.1702 GG KIT	1
44.1		> pump housing A 51.1702 GG	1
44.2		> o-ring ID.270,0x3,0 Viton	1
44.1.1	6073152	neck ring D.105x13 6051846 1.4470 VP. alternativ / alternative / alternative	1
44.1	6012861	pump housing A 51.1702 GG/C0	1
44.1	6012830	pump housing A 51.1702 GG/C1C1	1
44.1	6012845	pump housing A 51.1702 GG/C2C1	1
44.1	6012909	pump housing A 51.16785 1.4581	1
44.1	6022771	pump housing A 51.19190 Abrasit	1
44.1	6022779	pump housing A 53.19190 Abrasit/C0	1

CONTRACTOR'S PUMP KS70M UNIT (6000107)

Item	Article no.	Description	Quantity
45	6001371	strainer 53.17962 1.4301 KIT	1
45.1		> strainer 57x273x2 53.17962 1.4301	1
45.2		> base plate D.284 52.17961 Al	1
45.3		> screw M10x35 DIN933 A2-70	4
		alternativ / alternative / alternative	
45.1	6013069	strainer 57x273x2 53.17962 1.4301/CO	1
		Dubo-washer M10 NR.205 PA	4

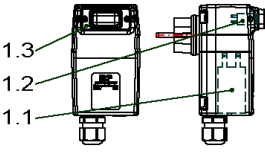
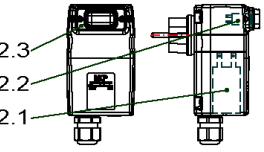
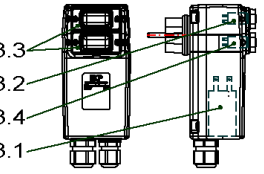
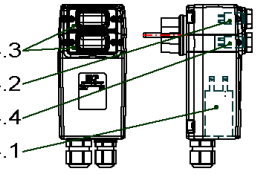
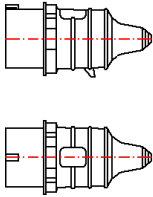
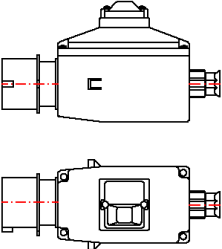
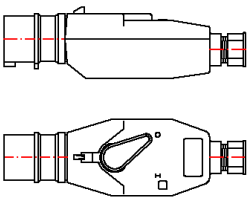
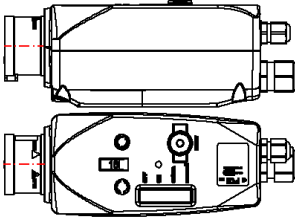
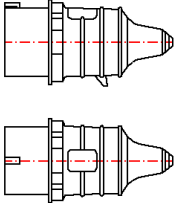
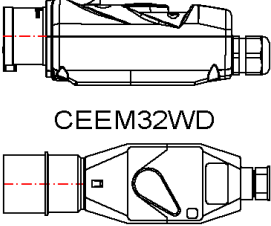
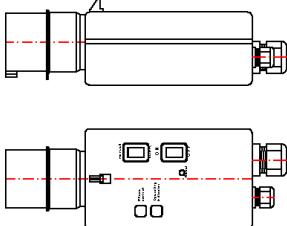
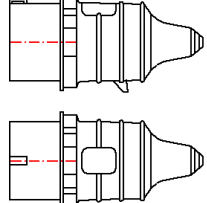
<p>1 MCP 6A-M-H-20μF ~ 230V</p>  <p>$I_N(230V / 50Hz) < 6A = 20\mu F$</p>	<p>2 MCP 10A-M-H-30μF ~ 230V</p>  <p>$I_N(230V / 50Hz) 6-10A = 30\mu F$</p>	<p>3 MCP 6A-M-HA-20μF ~ 230V</p>  <p>$I_N(230V / 50Hz) < 6A = 20\mu F$</p>	<p>4 MCP 10A-M-HA-30μF ~ 230V</p>  <p>$I_N(230V / 50Hz) 6-10A = 30\mu F$</p>
<p>5 CEE16A</p> 	<p>6 CEEM16W</p> 	<p>7 CEEM16WD</p> 	<p>8 MCP T4-HA-ROT-WSK CEE16-5PS</p> 
<p>9 CEE32A</p> 	<p>10 MCP 10-16A-T4-H-ROT CEE32-5PS</p>  <p>CEEM32WD</p>	<p>11 CEEM32WDSHA</p> 	<p>12 CEE63A</p> 

PLUG

Item	Article no.	Description	Quantity
		IN (230V / 50Hz) <6A - 20μF	
1	6072332	MCP 6A-M-H-20μF-CEE7/7 VP.	1
1.1	6071702	capacitor 400V 20μF MCP VP.	1
1.2	6071704	protection switch 6A MCP VP.	1
1.3	6071707	protecting cap MCP VP.	1
		IN (230V / 50Hz) 6-10A - 30μF	
2	6072330	MCP 10A-M-H-30μF-CEE7/7 VP.	1
2.1	6071703	capacitor 400V 30μF MCP VP.	1
2.2	6071705	protection switch 10A MCP VP.	1
2.3	6071707	protecting cap MCP VP.	1
		IN (230V / 50Hz) <6A - 20μF	
3	6072331	MCP 6A-M-HA-20μF-CEE7/7 VP.	1
3.1	6071702	capacitor 400V 20μF MCP VP.	1
3.2	6071704	protection switch 6A MCP VP.	1
3.3	6071707	protecting cap MCP VP.	2
3.4	6071706	switch on/out MCP VP.	1
		IN (230V / 50Hz) 6-10A - 30μF	
4	6072329	MCP 10A-M-HA-30μF-CEE7/7 VP	1
4.1	6071703	capacitor 400V 30μF MCP VP.	1
4.2	6071705	protection switch 10A MCP VP.	1
4.3	6071707	protecting cap MCP VP.	2
4.4	6071706	switch on/out MCP VP.	1
5	6003000	plug CEE16A/400V 60Hz/5P-11h	1
5	6003248	plug CEE16A/400V/4P-6H	1
5	6003009	plug CEE16A/400V/5P-6H	1
5	6039156	plug CEE16A/400V/5P-6H Phase inverter	1
5	6035231	plug CEE16A/400V/7P-6H	1
5	6003011	plug CEE16A/500V/5P-7H	1
6	6030883	plug MS400V5P CEE16A W 1,0-1,6A	1
6	6030884	plug MS400V5P CEE16A W 1,6-2,5A	1
6	6030888	plug MS400V5P CEE16A W 10,0-16,0A	1
6	6030885	plug MS400V5P CEE16A W 2,5-4,0A	1
6	6030886	plug MS400V5P CEE16A W 4,0-6,3A	1
6	6030887	plug MS400V5P CEE16A W 6,3-10,0A	1

PLUG

Item	Article no.	Description	Quantity
7	6032446	plug MS400V4P CEE16A WD 1,6-2,5A	1
7	6032447	plug MS400V4P CEE16A WD 12,5-16,0A	1
7	6032295	plug MS400V4P CEE16A WD 2,5-4,0A	1
7	6032289	plug MS400V4P CEE16A WD 4,0-6,3A	1
7	6032292	plug MS400V4P CEE16A WD 6,3-9,0A	1
7	6042190	plug MS400V5P CEE16A WDII 1,6-2,5A	1
7	6042194	plug MS400V5P CEE16A WDII 10,0-16,0A	1
7	6042191	plug MS400V5P CEE16A WDII 2,5-4,0A	1
7	6042192	plug MS400V5P CEE16A WDII 4,0-6,3A	1
7	6042193	plug MS400V5P CEE16A WDII 6,3-10,0A	1
7	6035911	plug MS400V5P CEE16A WD 9,0-12,5A	1
7	6003337	plug MS500V5P CEE16A WD 1,6-2,5A	1
7	6003336	plug MS500V5P CEE16A WD 2,5-4,0A	1
7	6003335	plug MS500V5P CEE16A WD 4,0-6,3A	1
7	6003334	plug MS500V5P CEE16A WD 6,3-9,0A	1
8	6072520	MCP 1,0-1,6A-T4-HA-ROT-WSK-CEE16-5PS VP.	1
8	6072521	MCP 1,6-2,4A-T4-HA-ROT-WSK-CEE16-5PS VP.	1
8	6072522	MCP 2,4-4,0A-T4-HA-ROT-WSK-CEE16-5PS VP.	1
8	6072523	MCP 4,0-6,0A-T4-HA-ROT-WSK-CEE16-5PS VP.	1
8	6072524	MCP 6,0-10A-T4-HA-ROT-WSK-CEE16-5PS VP.	1
8	6072525	MCP 9,0-12A-T4-HA-ROT-WSK-CEE16-5PS VP.	1
8	6072526	MCP 12-16A-T4-HA-ROT-WSK-CEE16-5PS VP.	1
9	6003267	plug CEE32A/400V/4P-6H	1
9	6039155	plug CEE32A/400V/5P-6H Phase inverter	1
9	6035895	plug CEE32A/500V/4P-7H AM-Top	1
9	6003010	plug CEE32A/500V/5P-7H	1
10	6072370	MCP 400V 1,6-2,5A-T4-H-ROT-CEE32-5PS VP.	1
10	6072369	MCP 400V 2,5-4,0A-T4-H-ROT-CEE32-5PS VP.	1
10	6072371	MCP 400V 4,0-6,3A-T4-H-ROT-CEE32-5PS VP.	1
10	6072398	MCP 400V 6,3-10A-T4-H-ROT-CEE32-5PS VP.	1
10	6072519	MCP 400V 10-16A-T4-H-ROT-CEE32-5PS VP.	1
10	6072399	MCP 400V 16-20A-T4-H-ROT-CEE32-5PS VP.	1
10	6072518	MCP 400V 20-25A-T4-H-ROT-CEE32-5PS VP.	1
10	6037649	plug.MS500V4P CEE32A WD 2,5-4,0A	1

PLUG

Item	Article no.	Description	Quantity
10	6041268	plug MS500V4P CEE32A WD 4,0-6,3A	1
10	6035244	plug MS500V5P CEE32A WD 1,6-2,5A	1
10	6034700	plug MS500V5P CEE32A WD 2,5-4,0A	1
10	6041556	plug MS500V5P CEE32A WD 4,0-6,3A	1
10	6002701	plug MS500V5P CEE32A WD 9,0-12,5A	1
10	6002700	plug MS500V5P CEE32A WD 12,5-16,0A	1
11	6003241	plug MS400V5P CEE32A WDSHA 10,0-14,0A	1
11	6003266	plug MS400V5P CEE32A WDSHA 3,7-5,5A	1
11	6003265	plug MS400V5P CEE32A WDSHA 5,5-8,0A	1
11	6003264	plug MS400V5P CEE32A WDSHA 8,0-11,5A	1
12	6003012	plug CEE63A/400V/5P-6H/IP67	1

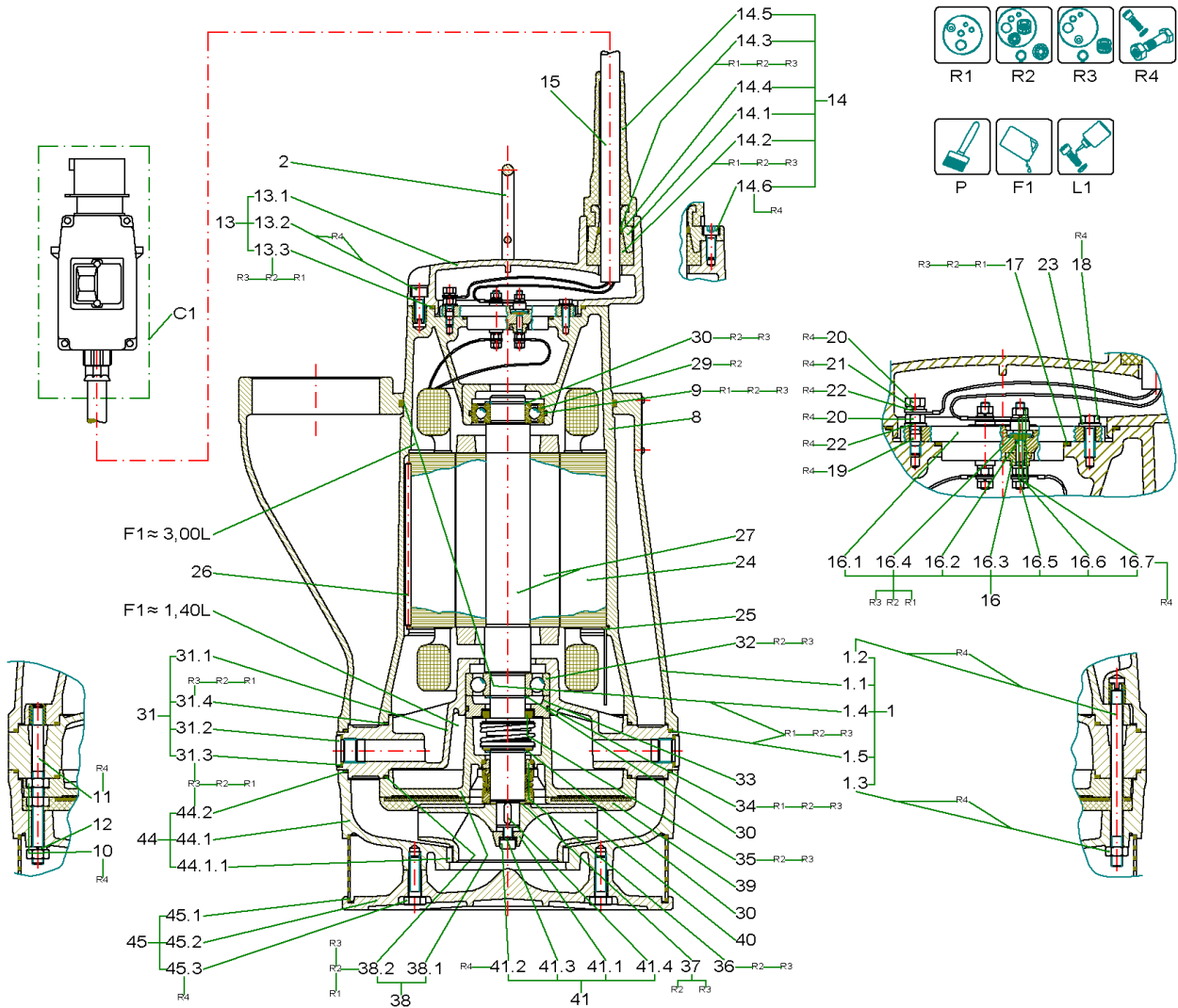

CONTRACTOR'S PUMP KS70N UNIT (6000108)

Item	Article no.	Description	Quantity
R1	6016259	Rep.Kit 1 KS37,70+Z Vit	1
R2	6016303	Rep.Kit 2 KS37,70 +Z Vit	1
R3	6016304	Rep.Kit 3 KS37,70+Z Vit	1
R4	6016128	Screws KS37,70 + Z KIT	1
P	6042254	PAINT SPRAY Pantone334	1
P	6042255	colour 2K-paint IV80 pantone334C 250ml	1
P	6023614	Ceram C0 black 100 ml KIT	1
P	6020579	Ceram C0 black 250 ml KIT	1
P	6023485	Ceram C0 Black 500ml Kit	1
P	6019157	Ceram C0 black 1000 ml KIT	1
F1	6025461	medical white oil 5L KIT	1
F1	6025460	medical white oil 1L KIT	1
L1	6080531	Loctite 243 5g flask VP:	1
L1	2096167	Loctite 243 50ml VP.	1

C1		PLUG	1

1		pump shroud SG4 1694 Al KIT	1
Note: nicht mehr lieferbar / no longer available / ne plus disponible			
1	6049611	pump shroud conversion KS70-KS70Z KIT	1
Note: Ersatz / replacement / remplacement			
2	6016511	handle 54.1649/1 A2	1
8		motor casing 51.1696 Al	1
8		No longer available	1
9	6078160	o-ring ID.62,0x3,0 Viton (3pc)	1
10		nut M10 DIN934 A4-80	6
11		screw M10x120 A2	2
12		lock washer 10 DIN7980 A4 (10pc)	1
13	6001675	motor cover 52.1695 GG KIT	1
13.1		> motor cover D.126g6 52.1695 GG	1
13.2		> screw M8x20 ISO4762 A2-70	5
13.3		> o-ring ID.122,0x3,0 Viton	1
alternativ / alternative / alternative			
13.1	6013978	motor cover D.126g6 52.1695 GG/C0	1

CONTRACTOR'S PUMP KS70N UNIT (6000108)

Item	Article no.	Description	Quantity
14	6018980	cable gland 54. 5696 GG KIT	1
14.1		> cable gland 54.5696 GG	1
14.2		> seal ring-profile 5612 CR	1
14.3		> pressure ring 20,5 16 0,8 PG16 DIN46320	1
14.4		> o-ring ID.16,0x4,5 Viton	1
14.5	6003826	> cable protection 140x45 mm NR50° Shore	1
14.6		> screw M8x20 ISO4762 A2-70	2
		Für Einschaltung Direkt	
		For direct-on-line starting	
		Pour démarrage direct	
15	6007639	cable NSSHÖU-J 4x2,5 round	
16	6001670	terminal board Melaminharz KIT	1
16.1		> terminal board Melaminharz	1
16.2		> duct bolt SW13x50 Ms	3
16.3		> pressure ring MS raw	3
16.4		> o-ring ID.5,0x2,0 NBR70	3
16.5		> washer A5,3 DIN125 A4	6
16.6		> lock washer 5 DIN7980 A4	9
16.7		> nut M5 DIN934 Ms	9
		Für Einschaltung Stern/Dreieck	
		For starting star-delta	
		Pour démarrage étoile-triangle	
15	6007534	cable NSSHÖU-J 7x1,5 round	
16	6024844	terminal board 53.11698 KIT	1
16.1		> terminal board Melaminharz	1
16.2		> duct bolt SW13x50 Ms	6
16.3		> pressure ring MS raw	6
16.4		> o-ring ID.5,0x2,0 NBR70	6
16.5		> washer A5,3 DIN125 A4	12
16.6		> lock washer 5 DIN7980 A4	18
16.7		> nut M5 DIN934 Ms	18

17		o-ring ID.65,0x3,0 Viton	1
18		screw M6x20 ISO4017 A2-70	3

CONTRACTOR'S PUMP KS70N UNIT (6000108)

Item	Article no.	Description	Quantity
19		screw M6x25 DIN939 A2-70	1
20		nut M6 DIN934 A4-80	2
21		lock washer 6 DIN7980 A4	1
22		washer A6,4 DIN125 A4	2
23		washer A6,4 DIN125 A4	3
24	6023487	stator F17-2/15 400/690 50Hz	1
		alternativ / alternative / alternative	
24	6023506	stator F17-2/15 230 50Hz	1
24	6023509	stator F17-2/15 500 50Hz VN01	1
25	6004661	circlips 174x2 54.1637 FSt	1
26	6035808	safety bar D.5x140 54.19444 St	1
27	6009989	rotor D.89,3x371 2/15 1.4021	1
29	6078164	ball bearing 6206 DDU C3 VP.	1
30	501355698	CIRCLIP 30X1,5 DIN471 FST	1
31	6001374	bearing housing U 51.1699 Al KIT	1
31.1		> bearing housing U 51.1699 Al	1
31.2	6067638	> screw plug G1/2 DIN908 A4 (3pcs)	1
31.3	6048832	> joint ring A21/26x1,5 DIN7603 PA(10pc)	1
31.4	6076642	> o-ring ID.203,0x3,0 Viton (3pc)	1
		alternativ / alternative / alternative	
31.1	6013940	bearing housing U 51.1699 Al/C0	1
31.1	6019019	bearing housing U 51.1699 Al/C1	1
32	6008974	ball bearing 6306	1
30	501355698	CIRCLIP 30X1,5 DIN471 FST	1
33	6009373	pressure ring D.72/39,2x19,1 55.1689 GG	1
34		o-ring ID.65,0x3,0 Viton	1
35	6077844	mech.seal MG1/30-G60-E1AQ1PGG VP.	1
		alternativ / alternative / alternative	
35	6074586	GRD. MG1/30-G4 Q1Q1VGG VP.	1
30	501355698	CIRCLIP 30X1,5 DIN471 FST	1
36	6074586	GRD. MG1/30-G4 Q1Q1VGG VP.	1
37	6002123	washer D.44/20x1 1.4301 -	1
38	6001372	sealing casing 52.1698/1 Al KIT	1
38.1		> sealing casing D.205g6 52.1698/1 Al	1

CONTRACTOR'S PUMP KS70N UNIT (6000108)

Item	Article no.	Description	Quantity
38.2	6076642	> o-ring ID.203,0x3,0 Viton (3pc) alternativ / alternative / alternative	1
38.1	6013727	sealing casing D.205 52.1698/1 Al/C0	1
39	6075378	wear plate 53.1693 Neoprene VP. Laufrad / Impeller / Roue 50Hz	1
40	6014080	impeller-M D.154 53.1273 GGG alternativ / alternative / alternative	1
40	6014078	impeller-M D.154 53.1273 GGG/C0	1
40	6010630	impeller-M D.154 53.17904 Abrasit	1
40	6022785	impeller-M D.154 53.17904 Abrasit/CO	1
40	6014079	impeller-M D.154 53.1273 1.4581 Laufrad / Impeller / Roue 60Hz	1
40	6014074	impeller-M D.142 53.1128 GGG alternativ / alternative / alternative	1
40	6021695	impeller-M D.142 53.1128 GGG/C0	1
40	6024441	impeller-M D.142 53.17904 Abrasit	1
40	6022784	impeller-M D.142 53.17904 Abrasit/CO	1
40	6021645	impeller-M D.142 53.1128 1.4581	1
41	6043597	impeller fixation 55.5399/1 1.4021 KIT	1
41.1		> washer D.26/9x13 55.5399/1	1
41.2	6003416	> screw M8x25 DIN912 10.9 Geomet	1
41.3	6002688	> screw locking Nord-Lock 13,5/8,7 A4	1
41.4	6004654	> key A 6x4x18 54.2589 A4	1
44	6001370	pump housing A 51.1702 GG KIT	1
44.1		> pump housing A 51.1702 GG	1
44.2		> o-ring ID.270,0x3,0 Viton	1
44.1.1	6073152	neck ring D.105x13 6051846 1.4470 VP. alternativ / alternative / alternative	1
44.1	6012861	pump housing A 51.1702 GG/C0	1
44.1	6012830	pump housing A 51.1702 GG/C1C1	1
44.1	6012845	pump housing A 51.1702 GG/C2C1	1
44.1	6012909	pump housing A 51.16785 1.4581	1
44.1	6022771	pump housing A 51.19190 Abrasit	1
44.1	6022779	pump housing A 53.19190 Abrasit/C0	1

CONTRACTOR'S PUMP KS70N UNIT (6000108)

Item	Article no.	Description	Quantity
45	6001371	strainer 53.17962 1.4301 KIT	1
45.1		> strainer 57x273x2 53.17962 1.4301	1
45.2		> base plate D.284 52.17961 Al	1
45.3		> screw M10x35 DIN933 A2-70	4
		alternativ / alternative / alternative	
45.1	6013069	strainer 57x273x2 53.17962 1.4301/CO	1
		Dubo-washer M10 NR.205 PA	4

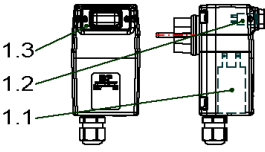
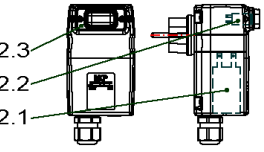
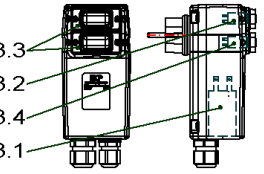
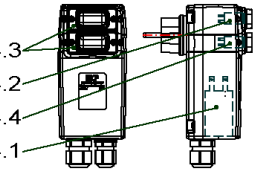
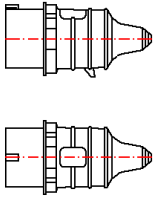
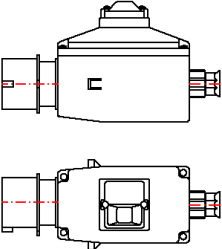
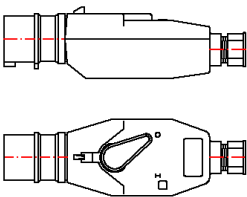
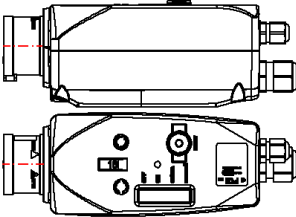
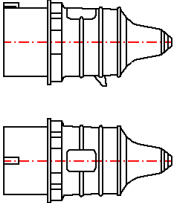
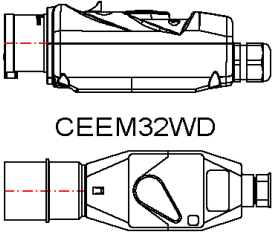
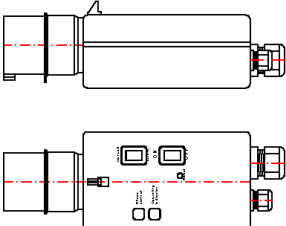
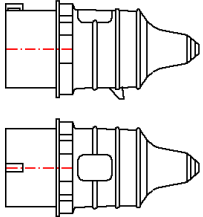
<p>1 MCP 6A-M-H-20μF ~ 230V</p>  <p>$I_N(230V / 50Hz) < 6A = 20\mu F$</p>	<p>2 MCP 10A-M-H-30μF ~ 230V</p>  <p>$I_N(230V / 50Hz) 6-10A = 30\mu F$</p>	<p>3 MCP 6A-M-HA-20μF ~ 230V</p>  <p>$I_N(230V / 50Hz) < 6A = 20\mu F$</p>	<p>4 MCP 10A-M-HA-30μF ~ 230V</p>  <p>$I_N(230V / 50Hz) 6-10A = 30\mu F$</p>
<p>5 CEE16A</p> 	<p>6 CEEM16W</p> 	<p>7 CEEM16WD</p> 	<p>8 MCP T4-HA-ROT-WSK CEE16-5PS</p> 
<p>9 CEE32A</p> 	<p>10 MCP 10-16A-T4-H-ROT CEE32-5PS</p>  <p>CEEM32WD</p>	<p>11 CEEM32WDSHA</p> 	<p>12 CEE63A</p> 

PLUG

Item	Article no.	Description	Quantity
		IN (230V / 50Hz) <6A - 20μF	
1	6072332	MCP 6A-M-H-20μF-CEE7/7 VP.	1
1.1	6071702	capacitor 400V 20μF MCP VP.	1
1.2	6071704	protection switch 6A MCP VP.	1
1.3	6071707	protecting cap MCP VP.	1
		IN (230V / 50Hz) 6-10A - 30μF	
2	6072330	MCP 10A-M-H-30μF-CEE7/7 VP.	1
2.1	6071703	capacitor 400V 30μF MCP VP.	1
2.2	6071705	protection switch 10A MCP VP.	1
2.3	6071707	protecting cap MCP VP.	1
		IN (230V / 50Hz) <6A - 20μF	
3	6072331	MCP 6A-M-HA-20μF-CEE7/7 VP.	1
3.1	6071702	capacitor 400V 20μF MCP VP.	1
3.2	6071704	protection switch 6A MCP VP.	1
3.3	6071707	protecting cap MCP VP.	2
3.4	6071706	switch on/out MCP VP.	1
		IN (230V / 50Hz) 6-10A - 30μF	
4	6072329	MCP 10A-M-HA-30μF-CEE7/7 VP	1
4.1	6071703	capacitor 400V 30μF MCP VP.	1
4.2	6071705	protection switch 10A MCP VP.	1
4.3	6071707	protecting cap MCP VP.	2
4.4	6071706	switch on/out MCP VP.	1
5	6003000	plug CEE16A/400V 60Hz/5P-11h	1
5	6003248	plug CEE16A/400V/4P-6H	1
5	6003009	plug CEE16A/400V/5P-6H	1
5	6039156	plug CEE16A/400V/5P-6H Phase inverter	1
5	6035231	plug CEE16A/400V/7P-6H	1
5	6003011	plug CEE16A/500V/5P-7H	1
6	6030883	plug MS400V5P CEE16A W 1,0-1,6A	1
6	6030884	plug MS400V5P CEE16A W 1,6-2,5A	1
6	6030888	plug MS400V5P CEE16A W 10,0-16,0A	1
6	6030885	plug MS400V5P CEE16A W 2,5-4,0A	1
6	6030886	plug MS400V5P CEE16A W 4,0-6,3A	1
6	6030887	plug MS400V5P CEE16A W 6,3-10,0A	1

PLUG

Item	Article no.	Description	Quantity
7	6032446	plug MS400V4P CEE16A WD 1,6-2,5A	1
7	6032447	plug MS400V4P CEE16A WD 12,5-16,0A	1
7	6032295	plug MS400V4P CEE16A WD 2,5-4,0A	1
7	6032289	plug MS400V4P CEE16A WD 4,0-6,3A	1
7	6032292	plug MS400V4P CEE16A WD 6,3-9,0A	1
7	6042190	plug MS400V5P CEE16A WDII 1,6-2,5A	1
7	6042194	plug MS400V5P CEE16A WDII 10,0-16,0A	1
7	6042191	plug MS400V5P CEE16A WDII 2,5-4,0A	1
7	6042192	plug MS400V5P CEE16A WDII 4,0-6,3A	1
7	6042193	plug MS400V5P CEE16A WDII 6,3-10,0A	1
7	6035911	plug MS400V5P CEE16A WD 9,0-12,5A	1
7	6003337	plug MS500V5P CEE16A WD 1,6-2,5A	1
7	6003336	plug MS500V5P CEE16A WD 2,5-4,0A	1
7	6003335	plug MS500V5P CEE16A WD 4,0-6,3A	1
7	6003334	plug MS500V5P CEE16A WD 6,3-9,0A	1
8	6072520	MCP 1,0-1,6A-T4-HA-ROT-WSK-CEE16-5PS VP.	1
8	6072521	MCP 1,6-2,4A-T4-HA-ROT-WSK-CEE16-5PS VP.	1
8	6072522	MCP 2,4-4,0A-T4-HA-ROT-WSK-CEE16-5PS VP.	1
8	6072523	MCP 4,0-6,0A-T4-HA-ROT-WSK-CEE16-5PS VP.	1
8	6072524	MCP 6,0-10A-T4-HA-ROT-WSK-CEE16-5PS VP.	1
8	6072525	MCP 9,0-12A-T4-HA-ROT-WSK-CEE16-5PS VP.	1
8	6072526	MCP 12-16A-T4-HA-ROT-WSK-CEE16-5PS VP.	1
9	6003267	plug CEE32A/400V/4P-6H	1
9	6039155	plug CEE32A/400V/5P-6H Phase inverter	1
9	6035895	plug CEE32A/500V/4P-7H AM-Top	1
9	6003010	plug CEE32A/500V/5P-7H	1
10	6072370	MCP 400V 1,6-2,5A-T4-H-ROT-CEE32-5PS VP.	1
10	6072369	MCP 400V 2,5-4,0A-T4-H-ROT-CEE32-5PS VP.	1
10	6072371	MCP 400V 4,0-6,3A-T4-H-ROT-CEE32-5PS VP.	1
10	6072398	MCP 400V 6,3-10A-T4-H-ROT-CEE32-5PS VP.	1
10	6072519	MCP 400V 10-16A-T4-H-ROT-CEE32-5PS VP.	1
10	6072399	MCP 400V 16-20A-T4-H-ROT-CEE32-5PS VP.	1
10	6072518	MCP 400V 20-25A-T4-H-ROT-CEE32-5PS VP.	1
10	6037649	plug.MS500V4P CEE32A WD 2,5-4,0A	1

PLUG

Item	Article no.	Description	Quantity
10	6041268	plug MS500V4P CEE32A WD 4,0-6,3A	1
10	6035244	plug MS500V5P CEE32A WD 1,6-2,5A	1
10	6034700	plug MS500V5P CEE32A WD 2,5-4,0A	1
10	6041556	plug MS500V5P CEE32A WD 4,0-6,3A	1
10	6002701	plug MS500V5P CEE32A WD 9,0-12,5A	1
10	6002700	plug MS500V5P CEE32A WD 12,5-16,0A	1
11	6003241	plug MS400V5P CEE32A WDSHA 10,0-14,0A	1
11	6003266	plug MS400V5P CEE32A WDSHA 3,7-5,5A	1
11	6003265	plug MS400V5P CEE32A WDSHA 5,5-8,0A	1
11	6003264	plug MS400V5P CEE32A WDSHA 8,0-11,5A	1
12	6003012	plug CEE63A/400V/5P-6H/IP67	1

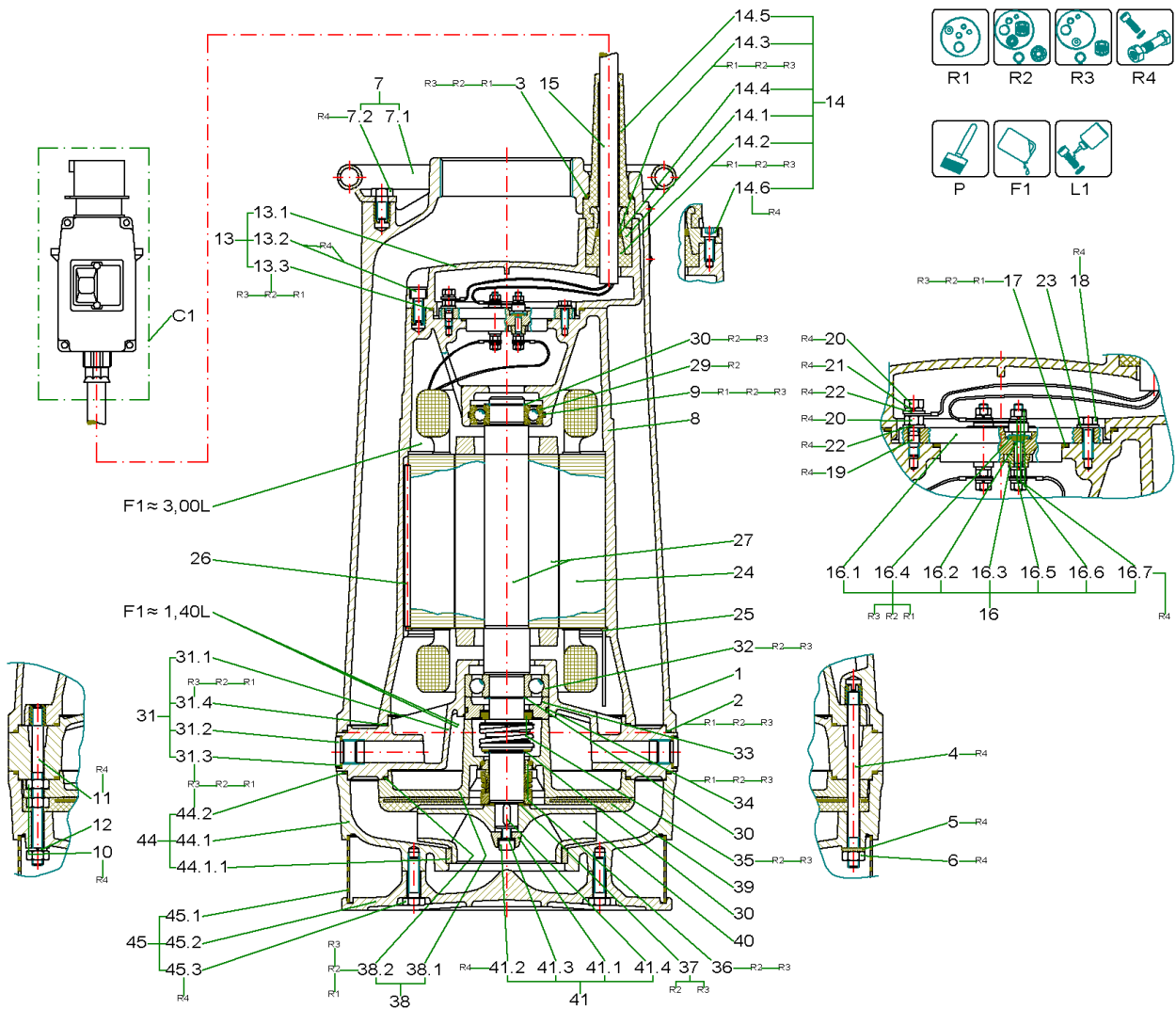

CONTRACTOR'S PUMP KS70ZH UNIT (6000109)

Item	Article no.	Description	Quantity
R1	6016259	Rep.Kit 1 KS37,70+Z Vit	1
R2	6016303	Rep.Kit 2 KS37,70 +Z Vit	1
R3	6016304	Rep.Kit 3 KS37,70+Z Vit	1
R4	6016128	Screws KS37,70 + Z KIT	1
P	6042254	PAINT SPRAY Pantone334	1
P	6042255	colour 2K-paint IV80 pantone334C 250ml	1
P	6023614	Ceram C0 black 100 ml KIT	1
P	6020579	Ceram C0 black 250 ml KIT	1
P	6023485	Ceram C0 Black 500ml Kit	1
P	6019157	Ceram C0 black 1000 ml KIT	1
F1	6025461	medical white oil 5L KIT	1
F1	6025460	medical white oil 1L KIT	1
L1	6080531	Loctite 243 5g flask VP:	1
L1	2096167	Loctite 243 50ml VP.	1

C1		PLUG	1

1	6017710	pump shroud ZG4 51.1225 Al alternativ / alternative / alternative	1
1	6017709	pump shroud ZG4 51.1225 Al/C0	1
1	6017717	pump shroud ZG4 51.17655 G-ALMg	1
1	6024666	pump shroud ZG4 51.17655 G-ALMg/C0	1
2		o-ring ID.270,0x3,0 Viton	1
3		o-ring ID.34,52x3,53 Viton	1
4		screw M10x140 DIN939 A2-70	4
5		Dubo-washer M10 NR.205 PA	4
6		nut M10 DIN934 A4-80 (20pc)	1
7	6001390	handle 52.1592 St vz KIT	1
7.1		> handle 52.1592 Stvz	1
7.2		> screw M10x20 DIN933 A4-70 alternativ / alternative / alternative	4
7.1	6016512	handle 52.1592 Stvz/C0	1
8	6013887	motor casing 51.1696 Al alternativ / alternative / alternative	1

CONTRACTOR'S PUMP KS70ZH UNIT (6000109)

Item	Article no.	Description	Quantity
8	6013896	motor casing 51.1696 Al/C0	1
9	6078160	o-ring ID.62,0x3,0 Viton (3pc)	1
10		nut M10 DIN934 A4-80 (20pc)	1
11		screw M10x120 A2	2
12		lock washer 10 DIN7980 A4 (10pc)	1
13	6001675	motor cover 52.1695 GG KIT	1
13.1		> motor cover D.126g6 52.1695 GG	1
13.2		> screw M8x20 ISO4762 A2-70	5
13.3		> o-ring ID.122,0x3,0 Viton	1
		alternativ / alternative / alternative	
13.1	6013978	motor cover D.126g6 52.1695 GG/C0	1
14	6018980	cable gland 54. 5696 GG KIT	1
14.1		> cable gland 54.5696 GG	1
14.2		> seal ring-profile 5612 CR	1
14.3		> pressure ring 20,5 16 0,8 PG16 DIN46320	1
14.4		> o-ring ID.16,0x4,5 Viton	1
14.5	6003826	> cable protection 140x45 mm NR50° Shore	1
14.6		> screw M8x20 ISO4762 A2-70	2
		Für Einschaltung Direkt	
		For direct-on-line starting	
		Pour démarrage direct	
15	6007639	cable NSSHÖU-J 4x2,5 round	
16	6001670	terminal board Melaminharz KIT	1
16.1		> terminal board Melaminharz	1
16.2		> duct bolt SW13x50 Ms	3
16.3		> pressure ring MS raw	3
16.4		> o-ring ID.5,0x2,0 NBR70	3
16.5		> washer A5,3 DIN125 A4	6
16.6		> lock washer 5 DIN7980 A4	9
16.7		> nut M5 DIN934 Ms	9
		Für Einschaltung Stern/Dreieck	
		For starting star-delta	
		Pour démarrage étoile-triangle	
15	6007534	cable NSSHÖU-J 7x1,5 round	

CONTRACTOR'S PUMP KS70ZH UNIT (6000109)

Item	Article no.	Description	Quantity
16	6024844	terminal board 53.11698 KIT	1
16.1		> terminal board Melaminharz	1
16.2		> duct bolt SW13x50 Ms	6
16.3		> pressure ring MS raw	6
16.4		> o-ring ID.5,0x2,0 NBR70	6
16.5		> washer A5,3 DIN125 A4	12
16.6		> lock washer 5 DIN7980 A4	18
16.7		> nut M5 DIN934 Ms	18

17		o-ring ID.65,0x3,0 Viton	1
18		screw M6x20 ISO4017 A2-70	3
19		screw M6x25 DIN939 A2-70	1
20		nut M6 DIN934 A4-80	2
21		lock washer 6 DIN7980 A4	1
22		washer A6,4 DIN125 A4	2
23		washer A6,4 DIN125 A4	3
24	6023487	stator F17-2/15 400/690 50Hz	1
		alternativ / alternative / alternative	
24	6023506	stator F17-2/15 230 50Hz	1
24	6023509	stator F17-2/15 500 50Hz VN01	1
24	6064205	stator F17-2/15 500 50Hz VN01 Bi 100	1
25	6004661	circlips 174x2 54.1637 FSt	1
26	6035808	safety bar D.5x140 54.19444 St	1
27	6009989	rotor D.89,3x371 2/15 1.4021	1
29	6078164	ball bearing 6206 DDU C3 VP.	1
30	501355698	CIRCLIP 30X1,5 DIN471 FST	1
31	6001374	bearing housing U 51.1699 AI KIT	1
31.1		> bearing housing U 51.1699 AI	1
31.2	6067638	> screw plug G1/2 DIN908 A4 (3pcs)	1
31.3	6048832	> joint ring A21/26x1,5 DIN7603 PA(10pc)	1
31.4	6076642	> o-ring ID.203,0x3,0 Viton (3pc)	1
		alternativ / alternative / alternative	
31.1	6013940	bearing housing U 51.1699 AI/C0	1
31.1	6019019	bearing housing U 51.1699 AI/C1	1

CONTRACTOR'S PUMP KS70ZH UNIT (6000109)

Item	Article no.	Description	Quantity
32	6008974	ball bearing 6306	1
30	501355698	CIRCLIP 30X1,5 DIN471 FST	1
33	6009373	pressure ring D.72/39,2x19,1 55.1689 GG	1
34		o-ring ID.65,0x3,0 Viton	1
35	6077844	mech.seal MG1/30-G60-E1AQ1PGG VP. alternativ / alternative / alternative	1
35	6074586	GRD. MG1/30-G4 Q1Q1VGG VP.	1
30	501355698	CIRCLIP 30X1,5 DIN471 FST	1
36	6074586	GRD. MG1/30-G4 Q1Q1VGG VP.	1
37	6002123	washer D.44/20x1 1.4301 -	1
38	6001372	sealing casing 52.1698/1 Al KIT	1
38.1		> sealing casing D.205g6 52.1698/1 Al	1
38.2	6076642	> o-ring ID.203,0x3,0 Viton (3pc) alternativ / alternative / alternative	1
38.1	6013727	sealing casing D.205 52.1698/1 Al/C0	1
39	6075378	wear plate 53.1693 Neoprene VP. Laufrad / Impeller / Roue 50Hz	1
40	6014063	impeller-M D.199 53.1378 GGG alternativ / alternative / alternative	1
40	6014061	impeller-M D.199 53.1378 GGG/C0 Laufrad / Impeller / Roue 60Hz	1
40	6014059	impeller-M D.182 53.1126 GGG alternativ / alternative / alternative	1
40	6021692	impeller-M D.182 53.1126 GGG/C0	1
41	6043597	impeller fixation 55.5399/1 1.4021 KIT	1
41.1		> washer D.26/9x13 55.5399/1	1
41.2	6003416	> screw M8x25 DIN912 10.9 Geomet	1
41.3	6002688	> screw locking Nord-Lock 13,5/8,7 A4	1
41.4	6004654	> key A 6x4x18 54.2589 A4	1
44	6001370	pump housing A 51.1702 GG KIT	1
44.1		> pump housing A 51.1702 GG	1
44.2		> o-ring ID.270,0x3,0 Viton	1
44.1.1	6073152	neck ring D.105x13 6051846 1.4470 VP. alternativ / alternative / alternative	1

CONTRACTOR'S PUMP KS70ZH UNIT (6000109)

Item	Article no.	Description	Quantity
44.1	6012861	pump housing A 51.1702 GG/C0	1
44.1	6012830	pump housing A 51.1702 GG/C1C1	1
44.1	6012845	pump housing A 51.1702 GG/C2C1	1
44.1	6012909	pump housing A 51.16785 1.4581	1
44.1	6022771	pump housing A 51.19190 Abrasit	1
44.1	6022779	pump housing A 53.19190 Abrasit/C0	1
45	6001371	strainer 53.17962 1.4301 KIT	1
45.1		> strainer 57x273x2 53.17962 1.4301	1
45.2		> base plate D.284 52.17961 Al	1
45.3		> screw M10x35 DIN933 A2-70	4
		alternativ / alternative / alternative	
45.1	6013069	strainer 57x273x2 53.17962 1.4301/CO	1

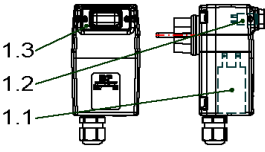
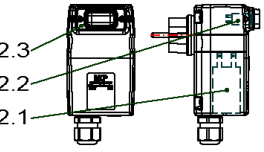
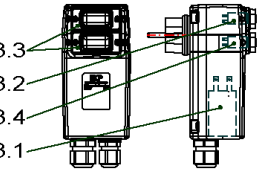
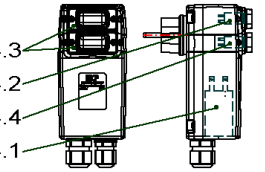
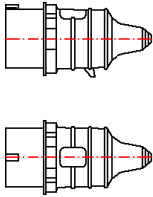
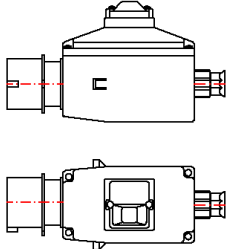
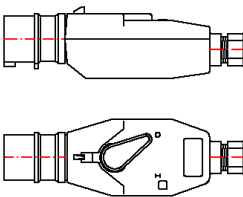
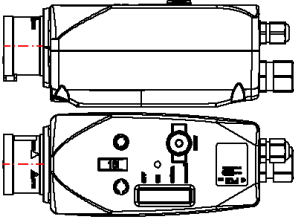
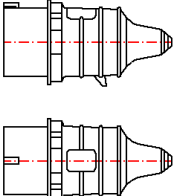
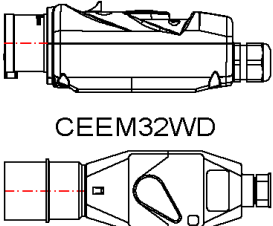
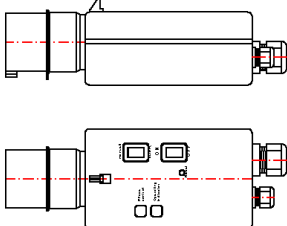
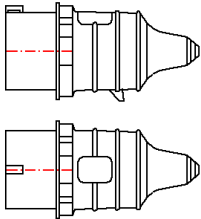
<p>1 MCP 6A-M-H-20μF ~ 230V</p>  <p>$I_N(230V / 50Hz) < 6A = 20\mu F$</p>	<p>2 MCP 10A-M-H-30μF ~ 230V</p>  <p>$I_N(230V / 50Hz) 6-10A = 30\mu F$</p>	<p>3 MCP 6A-M-HA-20μF ~ 230V</p>  <p>$I_N(230V / 50Hz) < 6A = 20\mu F$</p>	<p>4 MCP 10A-M-HA-30μF ~ 230V</p>  <p>$I_N(230V / 50Hz) 6-10A = 30\mu F$</p>
<p>5 CEE16A</p> 	<p>6 CEEM16W</p> 	<p>7 CEEM16WD</p> 	<p>8 MCP T4-HA-ROT-WSK CEE16-5PS</p> 
<p>9 CEE32A</p> 	<p>10 MCP 10-16A-T4-H-ROT CEE32-5PS</p>  <p>CEEM32WD</p>	<p>11 CEEM32WDSHA</p> 	<p>12 CEE63A</p> 

PLUG

Item	Article no.	Description	Quantity
		IN (230V / 50Hz) <6A - 20μF	
1	6072332	MCP 6A-M-H-20μF-CEE7/7 VP.	1
1.1	6071702	capacitor 400V 20μF MCP VP.	1
1.2	6071704	protection switch 6A MCP VP.	1
1.3	6071707	protecting cap MCP VP.	1
		IN (230V / 50Hz) 6-10A - 30μF	
2	6072330	MCP 10A-M-H-30μF-CEE7/7 VP.	1
2.1	6071703	capacitor 400V 30μF MCP VP.	1
2.2	6071705	protection switch 10A MCP VP.	1
2.3	6071707	protecting cap MCP VP.	1
		IN (230V / 50Hz) <6A - 20μF	
3	6072331	MCP 6A-M-HA-20μF-CEE7/7 VP.	1
3.1	6071702	capacitor 400V 20μF MCP VP.	1
3.2	6071704	protection switch 6A MCP VP.	1
3.3	6071707	protecting cap MCP VP.	2
3.4	6071706	switch on/out MCP VP.	1
		IN (230V / 50Hz) 6-10A - 30μF	
4	6072329	MCP 10A-M-HA-30μF-CEE7/7 VP	1
4.1	6071703	capacitor 400V 30μF MCP VP.	1
4.2	6071705	protection switch 10A MCP VP.	1
4.3	6071707	protecting cap MCP VP.	2
4.4	6071706	switch on/out MCP VP.	1
5	6003000	plug CEE16A/400V 60Hz/5P-11h	1
5	6003248	plug CEE16A/400V/4P-6H	1
5	6003009	plug CEE16A/400V/5P-6H	1
5	6039156	plug CEE16A/400V/5P-6H Phase inverter	1
5	6035231	plug CEE16A/400V/7P-6H	1
5	6003011	plug CEE16A/500V/5P-7H	1
6	6030883	plug MS400V5P CEE16A W 1,0-1,6A	1
6	6030884	plug MS400V5P CEE16A W 1,6-2,5A	1
6	6030888	plug MS400V5P CEE16A W 10,0-16,0A	1
6	6030885	plug MS400V5P CEE16A W 2,5-4,0A	1
6	6030886	plug MS400V5P CEE16A W 4,0-6,3A	1
6	6030887	plug MS400V5P CEE16A W 6,3-10,0A	1

PLUG

Item	Article no.	Description	Quantity
7	6032446	plug MS400V4P CEE16A WD 1,6-2,5A	1
7	6032447	plug MS400V4P CEE16A WD 12,5-16,0A	1
7	6032295	plug MS400V4P CEE16A WD 2,5-4,0A	1
7	6032289	plug MS400V4P CEE16A WD 4,0-6,3A	1
7	6032292	plug MS400V4P CEE16A WD 6,3-9,0A	1
7	6042190	plug MS400V5P CEE16A WDII 1,6-2,5A	1
7	6042194	plug MS400V5P CEE16A WDII 10,0-16,0A	1
7	6042191	plug MS400V5P CEE16A WDII 2,5-4,0A	1
7	6042192	plug MS400V5P CEE16A WDII 4,0-6,3A	1
7	6042193	plug MS400V5P CEE16A WDII 6,3-10,0A	1
7	6035911	plug MS400V5P CEE16A WD 9,0-12,5A	1
7	6003337	plug MS500V5P CEE16A WD 1,6-2,5A	1
7	6003336	plug MS500V5P CEE16A WD 2,5-4,0A	1
7	6003335	plug MS500V5P CEE16A WD 4,0-6,3A	1
7	6003334	plug MS500V5P CEE16A WD 6,3-9,0A	1
8	6072520	MCP 1,0-1,6A-T4-HA-ROT-WSK-CEE16-5PS VP.	1
8	6072521	MCP 1,6-2,4A-T4-HA-ROT-WSK-CEE16-5PS VP.	1
8	6072522	MCP 2,4-4,0A-T4-HA-ROT-WSK-CEE16-5PS VP.	1
8	6072523	MCP 4,0-6,0A-T4-HA-ROT-WSK-CEE16-5PS VP.	1
8	6072524	MCP 6,0-10A-T4-HA-ROT-WSK-CEE16-5PS VP.	1
8	6072525	MCP 9,0-12A-T4-HA-ROT-WSK-CEE16-5PS VP.	1
8	6072526	MCP 12-16A-T4-HA-ROT-WSK-CEE16-5PS VP.	1
9	6003267	plug CEE32A/400V/4P-6H	1
9	6039155	plug CEE32A/400V/5P-6H Phase inverter	1
9	6035895	plug CEE32A/500V/4P-7H AM-Top	1
9	6003010	plug CEE32A/500V/5P-7H	1
10	6072370	MCP 400V 1,6-2,5A-T4-H-ROT-CEE32-5PS VP.	1
10	6072369	MCP 400V 2,5-4,0A-T4-H-ROT-CEE32-5PS VP.	1
10	6072371	MCP 400V 4,0-6,3A-T4-H-ROT-CEE32-5PS VP.	1
10	6072398	MCP 400V 6,3-10A-T4-H-ROT-CEE32-5PS VP.	1
10	6072519	MCP 400V 10-16A-T4-H-ROT-CEE32-5PS VP.	1
10	6072399	MCP 400V 16-20A-T4-H-ROT-CEE32-5PS VP.	1
10	6072518	MCP 400V 20-25A-T4-H-ROT-CEE32-5PS VP.	1
10	6037649	plug.MS500V4P CEE32A WD 2,5-4,0A	1

PLUG

Item	Article no.	Description	Quantity
10	6041268	plug MS500V4P CEE32A WD 4,0-6,3A	1
10	6035244	plug MS500V5P CEE32A WD 1,6-2,5A	1
10	6034700	plug MS500V5P CEE32A WD 2,5-4,0A	1
10	6041556	plug MS500V5P CEE32A WD 4,0-6,3A	1
10	6002701	plug MS500V5P CEE32A WD 9,0-12,5A	1
10	6002700	plug MS500V5P CEE32A WD 12,5-16,0A	1
11	6003241	plug MS400V5P CEE32A WDSHA 10,0-14,0A	1
11	6003266	plug MS400V5P CEE32A WDSHA 3,7-5,5A	1
11	6003265	plug MS400V5P CEE32A WDSHA 5,5-8,0A	1
11	6003264	plug MS400V5P CEE32A WDSHA 8,0-11,5A	1
12	6003012	plug CEE63A/400V/5P-6H/IP67	1

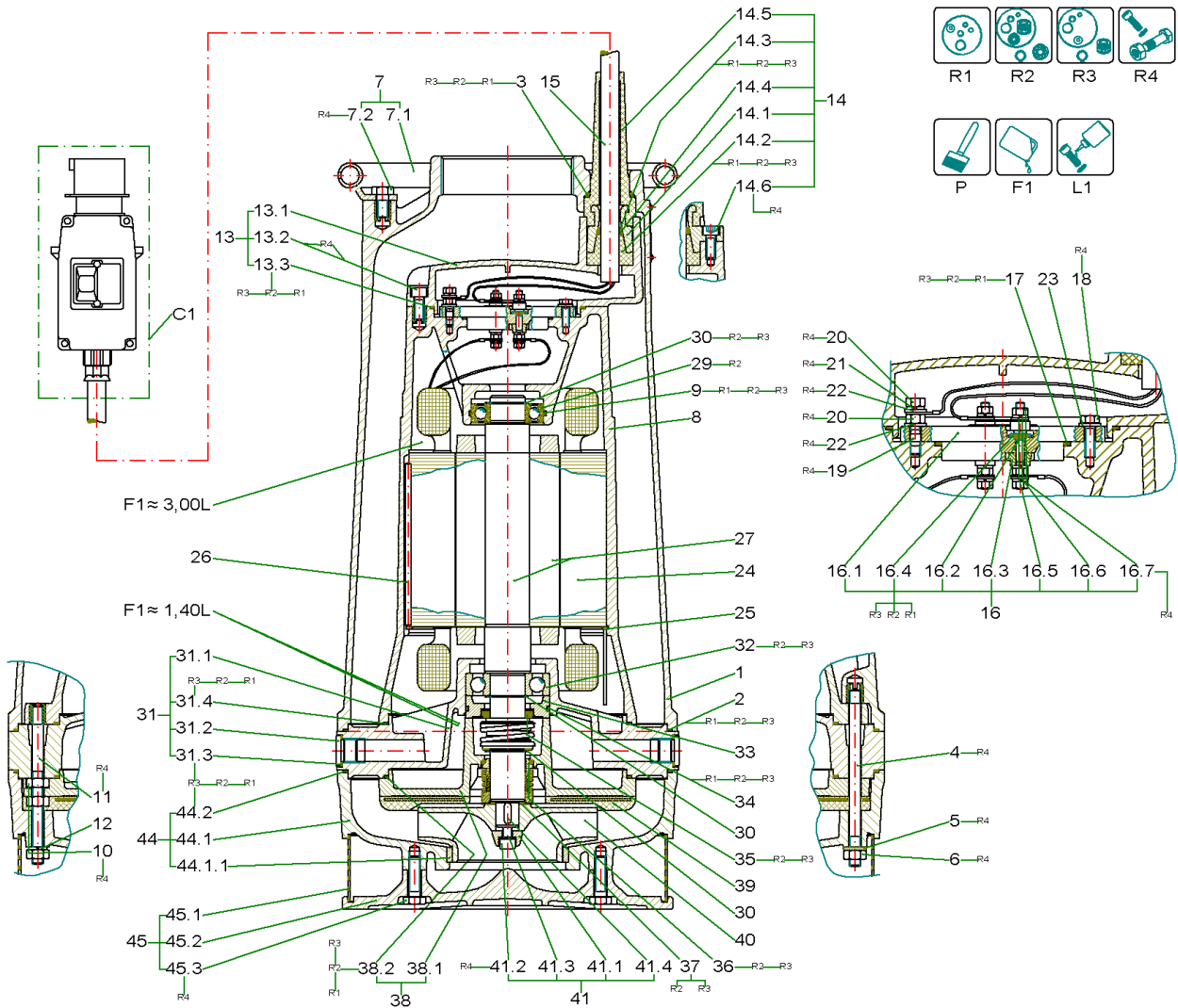

CONTRACTOR'S PUMP KS70ZM UNIT (6000110)

Item	Article no.	Description	Quantity
R1	6016259	Rep.Kit 1 KS37,70+Z Vit	1
R2	6016303	Rep.Kit 2 KS37,70 +Z Vit	1
R3	6016304	Rep.Kit 3 KS37,70+Z Vit	1
R4	6016128	Screws KS37,70 + Z KIT	1
P	6042254	PAINT SPRAY Pantone334	1
P	6042255	colour 2K-paint IV80 pantone334C 250ml	1
P	6023614	Ceram C0 black 100 ml KIT	1
P	6020579	Ceram C0 black 250 ml KIT	1
P	6023485	Ceram C0 Black 500ml Kit	1
P	6019157	Ceram C0 black 1000 ml KIT	1
F1	6025461	medical white oil 5L KIT	1
F1	6025460	medical white oil 1L KIT	1
L1	6080531	Loctite 243 5g flask VP:	1
L1	2096167	Loctite 243 50ml VP.	1

C1		PLUG	1

1	6017710	pump shroud ZG4 51.1225 Al alternativ / alternative / alternative	1
1	6017709	pump shroud ZG4 51.1225 Al/C0	1
1	6017717	pump shroud ZG4 51.17655 G-ALMg	1
1	6024666	pump shroud ZG4 51.17655 G-ALMg/C0	1
2		o-ring ID.270,0x3,0 Viton	1
3		o-ring ID.34,52x3,53 Viton	1
4		screw M10x140 DIN939 A2-70	4
5		Dubo-washer M10 NR.205 PA	4
6		nut M10 DIN934 A4-80 (20pc)	1
7	6001390	handle 52.1592 St vz KIT	1
7.1		> handle 52.1592 Stvz	1
7.2		> screw M10x20 DIN933 A4-70 alternativ / alternative / alternative	4
7.1	6016512	handle 52.1592 Stvz/C0	1
8	6013887	motor casing 51.1696 Al alternativ / alternative / alternative	1

CONTRACTOR'S PUMP KS70ZM UNIT (6000110)

Item	Article no.	Description	Quantity
8	6013896	motor casing 51.1696 Al/C0	1
9	6078160	o-ring ID.62,0x3,0 Viton (3pc)	1
10		nut M10 DIN934 A4-80 (20pc)	1
11		screw M10x120 A2	2
12		lock washer 10 DIN7980 A4 (10pc)	1
13	6001675	motor cover 52.1695 GG KIT	1
13.1		> motor cover D.126g6 52.1695 GG	1
13.2		> screw M8x20 ISO4762 A2-70	5
13.3		> o-ring ID.122,0x3,0 Viton	1
		alternativ / alternative / alternative	
13.1	6013978	motor cover D.126g6 52.1695 GG/C0	1
14	6018980	cable gland 54. 5696 GG KIT	1
14.1		> cable gland 54.5696 GG	1
14.2		> seal ring-profile 5612 CR	1
14.3		> pressure ring 20,5 16 0,8 PG16 DIN46320	1
14.4		> o-ring ID.16,0x4,5 Viton	1
14.5	6003826	> cable protection 140x45 mm NR50° Shore	1
14.6		> screw M8x20 ISO4762 A2-70	2
		Für Einschaltung Direkt	
		For direct-on-line starting	
		Pour démarrage direct	
15	6007639	cable NSSHÖU-J 4x2,5 round	
16	6001670	terminal board Melaminharz KIT	1
16.1		> terminal board Melaminharz	1
16.2		> duct bolt SW13x50 Ms	3
16.3		> pressure ring MS raw	3
16.4		> o-ring ID.5,0x2,0 NBR70	3
16.5		> washer A5,3 DIN125 A4	6
16.6		> lock washer 5 DIN7980 A4	9
16.7		> nut M5 DIN934 Ms	9
		Für Einschaltung Stern/Dreieck	
		For starting star-delta	
		Pour démarrage étoile-triangle	
15	6007534	cable NSSHÖU-J 7x1,5 round	

CONTRACTOR'S PUMP KS70ZM UNIT (6000110)

Item	Article no.	Description	Quantity
16	6024844	terminal board 53.11698 KIT	1
16.1		> terminal board Melaminharz	1
16.2		> duct bolt SW13x50 Ms	6
16.3		> pressure ring MS raw	6
16.4		> o-ring ID.5,0x2,0 NBR70	6
16.5		> washer A5,3 DIN125 A4	12
16.6		> lock washer 5 DIN7980 A4	18
16.7		> nut M5 DIN934 Ms	18

17		o-ring ID.65,0x3,0 Viton	1
18		screw M6x20 ISO4017 A2-70	3
19		screw M6x25 DIN939 A2-70	1
20		nut M6 DIN934 A4-80	2
21		lock washer 6 DIN7980 A4	1
22		washer A6,4 DIN125 A4	2
23		washer A6,4 DIN125 A4	3
24	6023487	stator F17-2/15 400/690 50Hz	1
		alternativ / alternative / alternative	
24	6023506	stator F17-2/15 230 50Hz	1
24	6023509	stator F17-2/15 500 50Hz VN01	1
24	6064205	stator F17-2/15 500 50Hz VN01 Bi 100	1
25	6004661	circlips 174x2 54.1637 FSt	1
26	6035808	safety bar D.5x140 54.19444 St	1
27	6009989	rotor D.89,3x371 2/15 1.4021	1
29	6078164	ball bearing 6206 DDU C3 VP.	1
30	501355698	CIRCLIP 30X1,5 DIN471 FST	1
31	6001374	bearing housing U 51.1699 AI KIT	1
31.1		> bearing housing U 51.1699 AI	1
31.2	6067638	> screw plug G1/2 DIN908 A4 (3pcs)	1
31.3	6048832	> joint ring A21/26x1,5 DIN7603 PA(10pc)	1
31.4	6076642	> o-ring ID.203,0x3,0 Viton (3pc)	1
		alternativ / alternative / alternative	
31.1	6013940	bearing housing U 51.1699 AI/C0	1
31.1	6019019	bearing housing U 51.1699 AI/C1	1

CONTRACTOR'S PUMP KS70ZM UNIT (6000110)

Item	Article no.	Description	Quantity
32	6008974	ball bearing 6306	1
30	501355698	CIRCLIP 30X1,5 DIN471 FST	1
33	6009373	pressure ring D.72/39,2x19,1 55.1689 GG	1
34		o-ring ID.65,0x3,0 Viton	1
35	6077844	mech.seal MG1/30-G60-E1AQ1PGG VP. alternativ / alternative / alternative	1
35	6074586	GRD. MG1/30-G4 Q1Q1VGG VP.	1
30	501355698	CIRCLIP 30X1,5 DIN471 FST	1
36	6074586	GRD. MG1/30-G4 Q1Q1VGG VP.	1
37	6002123	washer D.44/20x1 1.4301 -	1
38	6001372	sealing casing 52.1698/1 Al KIT	1
38.1		> sealing casing D.205g6 52.1698/1 Al	1
38.2	6076642	> o-ring ID.203,0x3,0 Viton (3pc) alternativ / alternative / alternative	1
38.1	6013727	sealing casing D.205 52.1698/1 Al/CO	1
39	6075378	wear plate 53.1693 Neoprene VP. Laufrad / Impeller / Roue 50Hz	1
40	6014077	impeller-M D.182 53.1364 GGG alternativ / alternative / alternative	1
40	6014064	impeller-M D.182 53.1364 GGG/CO	1
40	6010624	impeller-M D.182 53.17905 Abrasit	1
40	6022783	impeller-M D.182 53.17905 Abrasit/CO	1
40	6014076	impeller-M D.182 53.1364 1.4581 Laufrad / Impeller / Roue 60Hz	1
40	6014075	impeller-M D.160 53.1127 GGG alternativ / alternative / alternative	1
40	6021694	impeller-M D.160 53.1127 GGG/CO	1
40	6024440	impeller-M D.160 53.17905 Abrasit	1
40	6022782	impeller-M D.160 53.17905 Abrasit/CO	1
40	6021644	impeller-M D.160 53.1127 1.4581	1
41	6043597	impeller fixation 55.5399/1 1.4021 KIT	1
41.1		> washer D.26/9x13 55.5399/1	1
41.2	6003416	> screw M8x25 DIN912 10.9 Geomet	1
41.3	6002688	> screw locking Nord-Lock 13,5/8,7 A4	1

CONTRACTOR'S PUMP KS70ZM UNIT (6000110)

Item	Article no.	Description	Quantity
41.4	6004654	> key A 6x4x18 54.2589 A4	1
44	6001370	pump housing A 51.1702 GG KIT	1
44.1		> pump housing A 51.1702 GG	1
44.2		> o-ring ID.270,0x3,0 Viton	1
44.1.1	6073152	neck ring D.105x13 6051846 1.4470 VP. alternativ / alternative / alternative	1
44.1	6012861	pump housing A 51.1702 GG/CO	1
44.1	6012830	pump housing A 51.1702 GG/C1C1	1
44.1	6012845	pump housing A 51.1702 GG/C2C1	1
44.1	6012909	pump housing A 51.16785 1.4581	1
44.1	6022771	pump housing A 51.19190 Abrasit	1
44.1	6022779	pump housing A 53.19190 Abrasit/CO	1
45	6001371	strainer 53.17962 1.4301 KIT	1
45.1		> strainer 57x273x2 53.17962 1.4301	1
45.2		> base plate D.284 52.17961 Al	1
45.3		> screw M10x35 DIN933 A2-70 alternativ / alternative / alternative	4
45.1	6013069	strainer 57x273x2 53.17962 1.4301/CO	1

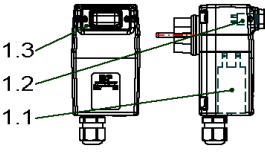
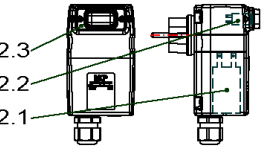
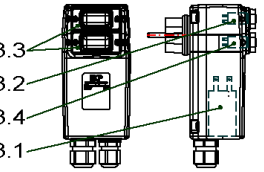
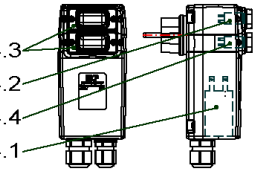
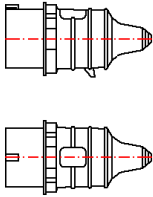
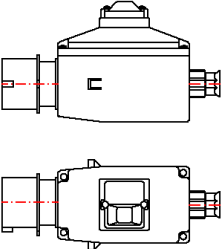
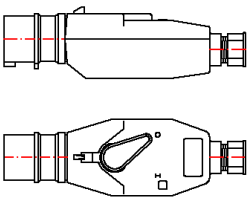
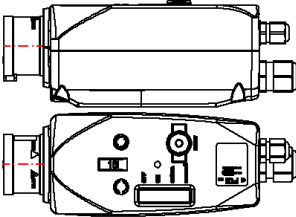
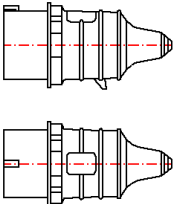
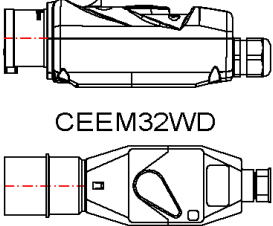
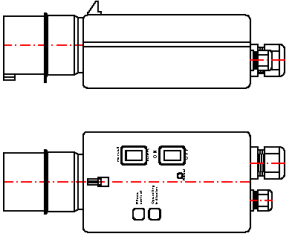
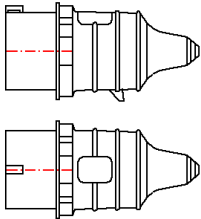
<p>1 MCP 6A-M-H-20μF ~ 230V</p>  <p>$I_N(230V / 50Hz) < 6A = 20\mu F$</p>	<p>2 MCP 10A-M-H-30μF ~ 230V</p>  <p>$I_N(230V / 50Hz) 6-10A = 30\mu F$</p>	<p>3 MCP 6A-M-HA-20μF ~ 230V</p>  <p>$I_N(230V / 50Hz) < 6A = 20\mu F$</p>	<p>4 MCP 10A-M-HA-30μF ~ 230V</p>  <p>$I_N(230V / 50Hz) 6-10A = 30\mu F$</p>
<p>5 CEE16A</p> 	<p>6 CEEM16W</p> 	<p>7 CEEM16WD</p> 	<p>8 MCP T4-HA-ROT-WSK CEE16-5PS</p> 
<p>9 CEE32A</p> 	<p>10 MCP 10-16A-T4-H-ROT CEE32-5PS</p>  <p>CEEM32WD</p>	<p>11 CEEM32WDSHA</p> 	<p>12 CEE63A</p> 

PLUG

Item	Article no.	Description	Quantity
		IN (230V / 50Hz) <6A - 20µF	
1	6072332	MCP 6A-M-H-20µF-CEE7/7 VP.	1
1.1	6071702	capacitor 400V 20µF MCP VP.	1
1.2	6071704	protection switch 6A MCP VP.	1
1.3	6071707	protecting cap MCP VP.	1
		IN (230V / 50Hz) 6-10A - 30µF	
2	6072330	MCP 10A-M-H-30µF-CEE7/7 VP.	1
2.1	6071703	capacitor 400V 30µF MCP VP.	1
2.2	6071705	protection switch 10A MCP VP.	1
2.3	6071707	protecting cap MCP VP.	1
		IN (230V / 50Hz) <6A - 20µF	
3	6072331	MCP 6A-M-HA-20µF-CEE7/7 VP.	1
3.1	6071702	capacitor 400V 20µF MCP VP.	1
3.2	6071704	protection switch 6A MCP VP.	1
3.3	6071707	protecting cap MCP VP.	2
3.4	6071706	switch on/out MCP VP.	1
		IN (230V / 50Hz) 6-10A - 30µF	
4	6072329	MCP 10A-M-HA-30µF-CEE7/7 VP	1
4.1	6071703	capacitor 400V 30µF MCP VP.	1
4.2	6071705	protection switch 10A MCP VP.	1
4.3	6071707	protecting cap MCP VP.	2
4.4	6071706	switch on/out MCP VP.	1
5	6003000	plug CEE16A/400V 60Hz/5P-11h	1
5	6003248	plug CEE16A/400V/4P-6H	1
5	6003009	plug CEE16A/400V/5P-6H	1
5	6039156	plug CEE16A/400V/5P-6H Phase inverter	1
5	6035231	plug CEE16A/400V/7P-6H	1
5	6003011	plug CEE16A/500V/5P-7H	1
6	6030883	plug MS400V5P CEE16A W 1,0-1,6A	1
6	6030884	plug MS400V5P CEE16A W 1,6-2,5A	1
6	6030888	plug MS400V5P CEE16A W 10,0-16,0A	1
6	6030885	plug MS400V5P CEE16A W 2,5-4,0A	1
6	6030886	plug MS400V5P CEE16A W 4,0-6,3A	1
6	6030887	plug MS400V5P CEE16A W 6,3-10,0A	1

PLUG

Item	Article no.	Description	Quantity
7	6032446	plug MS400V4P CEE16A WD 1,6-2,5A	1
7	6032447	plug MS400V4P CEE16A WD 12,5-16,0A	1
7	6032295	plug MS400V4P CEE16A WD 2,5-4,0A	1
7	6032289	plug MS400V4P CEE16A WD 4,0-6,3A	1
7	6032292	plug MS400V4P CEE16A WD 6,3-9,0A	1
7	6042190	plug MS400V5P CEE16A WDII 1,6-2,5A	1
7	6042194	plug MS400V5P CEE16A WDII 10,0-16,0A	1
7	6042191	plug MS400V5P CEE16A WDII 2,5-4,0A	1
7	6042192	plug MS400V5P CEE16A WDII 4,0-6,3A	1
7	6042193	plug MS400V5P CEE16A WDII 6,3-10,0A	1
7	6035911	plug MS400V5P CEE16A WD 9,0-12,5A	1
7	6003337	plug MS500V5P CEE16A WD 1,6-2,5A	1
7	6003336	plug MS500V5P CEE16A WD 2,5-4,0A	1
7	6003335	plug MS500V5P CEE16A WD 4,0-6,3A	1
7	6003334	plug MS500V5P CEE16A WD 6,3-9,0A	1
8	6072520	MCP 1,0-1,6A-T4-HA-ROT-WSK-CEE16-5PS VP.	1
8	6072521	MCP 1,6-2,4A-T4-HA-ROT-WSK-CEE16-5PS VP.	1
8	6072522	MCP 2,4-4,0A-T4-HA-ROT-WSK-CEE16-5PS VP.	1
8	6072523	MCP 4,0-6,0A-T4-HA-ROT-WSK-CEE16-5PS VP.	1
8	6072524	MCP 6,0-10A-T4-HA-ROT-WSK-CEE16-5PS VP.	1
8	6072525	MCP 9,0-12A-T4-HA-ROT-WSK-CEE16-5PS VP.	1
8	6072526	MCP 12-16A-T4-HA-ROT-WSK-CEE16-5PS VP.	1
9	6003267	plug CEE32A/400V/4P-6H	1
9	6039155	plug CEE32A/400V/5P-6H Phase inverter	1
9	6035895	plug CEE32A/500V/4P-7H AM-Top	1
9	6003010	plug CEE32A/500V/5P-7H	1
10	6072370	MCP 400V 1,6-2,5A-T4-H-ROT-CEE32-5PS VP.	1
10	6072369	MCP 400V 2,5-4,0A-T4-H-ROT-CEE32-5PS VP.	1
10	6072371	MCP 400V 4,0-6,3A-T4-H-ROT-CEE32-5PS VP.	1
10	6072398	MCP 400V 6,3-10A-T4-H-ROT-CEE32-5PS VP.	1
10	6072519	MCP 400V 10-16A-T4-H-ROT-CEE32-5PS VP.	1
10	6072399	MCP 400V 16-20A-T4-H-ROT-CEE32-5PS VP.	1
10	6072518	MCP 400V 20-25A-T4-H-ROT-CEE32-5PS VP.	1
10	6037649	plug.MS500V4P CEE32A WD 2,5-4,0A	1

PLUG

Item	Article no.	Description	Quantity
10	6041268	plug MS500V4P CEE32A WD 4,0-6,3A	1
10	6035244	plug MS500V5P CEE32A WD 1,6-2,5A	1
10	6034700	plug MS500V5P CEE32A WD 2,5-4,0A	1
10	6041556	plug MS500V5P CEE32A WD 4,0-6,3A	1
10	6002701	plug MS500V5P CEE32A WD 9,0-12,5A	1
10	6002700	plug MS500V5P CEE32A WD 12,5-16,0A	1
11	6003241	plug MS400V5P CEE32A WDSHA 10,0-14,0A	1
11	6003266	plug MS400V5P CEE32A WDSHA 3,7-5,5A	1
11	6003265	plug MS400V5P CEE32A WDSHA 5,5-8,0A	1
11	6003264	plug MS400V5P CEE32A WDSHA 8,0-11,5A	1
12	6003012	plug CEE63A/400V/5P-6H/IP67	1

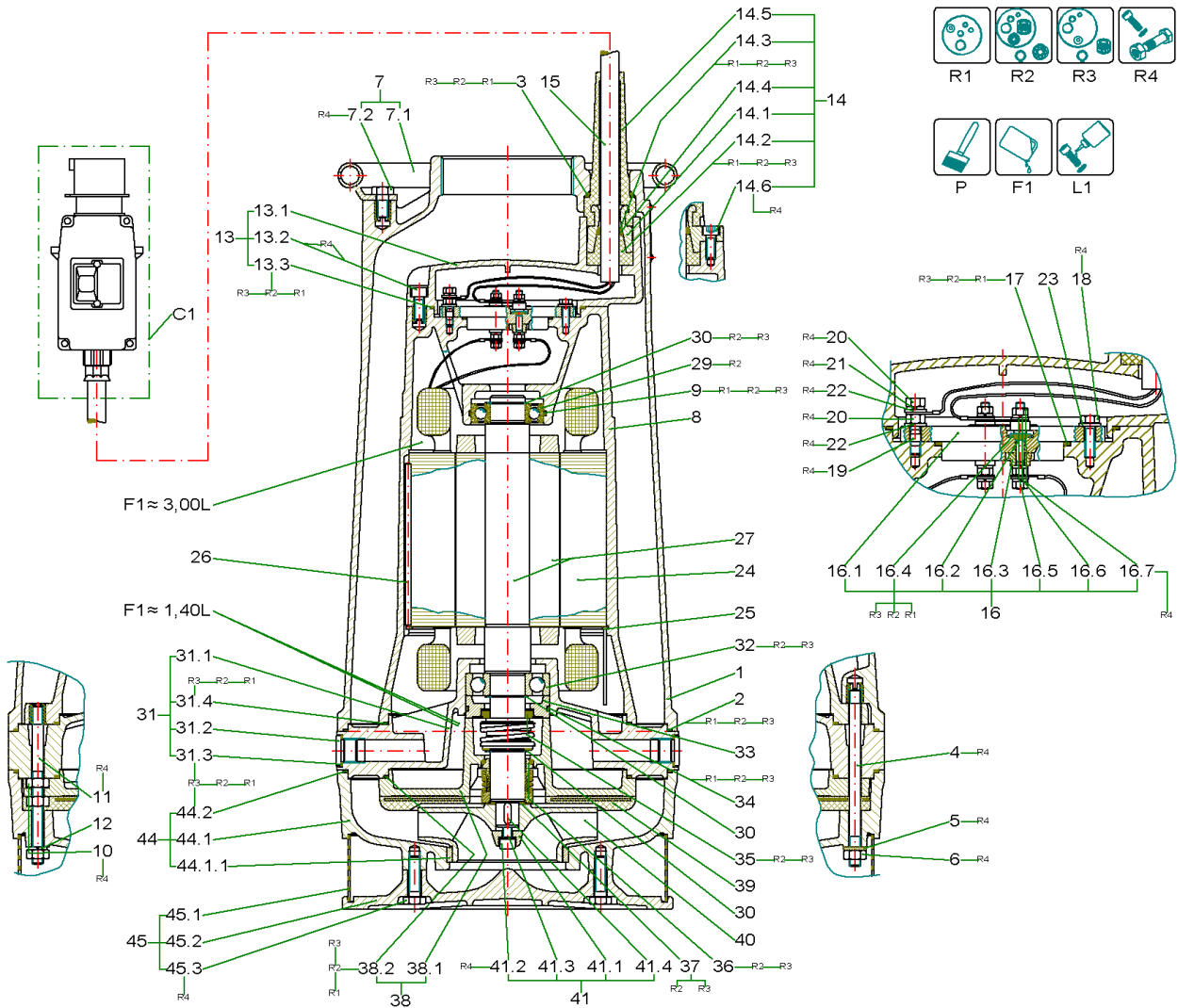

CONTRACTOR'S PUMP KS70ZN UNIT (6000111)

Item	Article no.	Description	Quantity
R1	6016259	Rep.Kit 1 KS37,70+Z Vit	1
R2	6016303	Rep.Kit 2 KS37,70 +Z Vit	1
R3	6016304	Rep.Kit 3 KS37,70+Z Vit	1
R4	6016128	Screws KS37,70 + Z KIT	1
P	6042254	PAINT SPRAY Pantone334	1
P	6042255	colour 2K-paint IV80 pantone334C 250ml	1
P	6023614	Ceram C0 black 100 ml KIT	1
P	6020579	Ceram C0 black 250 ml KIT	1
P	6023485	Ceram C0 Black 500ml Kit	1
P	6019157	Ceram C0 black 1000 ml KIT	1
F1	6025461	medical white oil 5L KIT	1
F1	6025460	medical white oil 1L KIT	1
L1	6080531	Loctite 243 5g flask VP:	1
L1	2096167	Loctite 243 50ml VP.	1

C1		PLUG	1

1	6017710	pump shroud ZG4 51.1225 Al	1
		alternativ / alternative / alternative	
1	6017709	pump shroud ZG4 51.1225 Al/C0	1
1	6017717	pump shroud ZG4 51.17655 G-ALMg	1
1	6024666	pump shroud ZG4 51.17655 G-ALMg/C0	1
2		o-ring ID.270,0x3,0 Viton	1
3		o-ring ID.34,52x3,53 Viton	1
4		screw M10x140 DIN939 A2-70	4
5		Dubo-washer M10 NR.205 PA	4
6		nut M10 DIN934 A4-80 (20pc)	1
7	6001390	handle 52.1592 St vz KIT	1
7.1		> handle 52.1592 Stvz	1
7.2		> screw M10x20 DIN933 A4-70	4
		alternativ / alternative / alternative	
7.1	6016512	handle 52.1592 Stvz/C0	1
8	6013887	motor casing 51.1696 Al	1
		alternativ / alternative / alternative	

CONTRACTOR'S PUMP KS70ZN UNIT (6000111)

Item	Article no.	Description	Quantity
8	6013896	motor casing 51.1696 Al/C0	1
9	6078160	o-ring ID.62,0x3,0 Viton (3pc)	1
10		nut M10 DIN934 A4-80 (20pc)	1
11		screw M10x120 A2	2
12		lock washer 10 DIN7980 A4 (10pc)	1
13	6001675	motor cover 52.1695 GG KIT	1
13.1		> motor cover D.126g6 52.1695 GG	1
13.2		> screw M8x20 ISO4762 A2-70	5
13.3		> o-ring ID.122,0x3,0 Viton	1
		alternativ / alternative / alternative	
13.1	6013978	motor cover D.126g6 52.1695 GG/C0	1
14	6018980	cable gland 54. 5696 GG KIT	1
14.1		> cable gland 54.5696 GG	1
14.2		> seal ring-profile 5612 CR	1
14.3		> pressure ring 20,5 16 0,8 PG16 DIN46320	1
14.4		> o-ring ID.16,0x4,5 Viton	1
14.5	6003826	> cable protection 140x45 mm NR50° Shore	1
14.6		> screw M8x20 ISO4762 A2-70	2
		Für Einschaltung Direkt	
		For direct-on-line starting	
		Pour démarrage direct	
15	6007639	cable NSSHÖU-J 4x2,5 round	
16	6001670	terminal board Melaminharz KIT	1
16.1		> terminal board Melaminharz	1
16.2		> duct bolt SW13x50 Ms	3
16.3		> pressure ring MS raw	3
16.4		> o-ring ID.5,0x2,0 NBR70	3
16.5		> washer A5,3 DIN125 A4	6
16.6		> lock washer 5 DIN7980 A4	9
16.7		> nut M5 DIN934 Ms	9
		Für Einschaltung Stern/Dreieck	
		For starting star-delta	
		Pour démarrage étoile-triangle	
15	6007534	cable NSSHÖU-J 7x1,5 round	

CONTRACTOR'S PUMP KS70ZN UNIT (6000111)

Item	Article no.	Description	Quantity
16	6024844	terminal board 53.11698 KIT	1
16.1		> terminal board Melaminharz	1
16.2		> duct bolt SW13x50 Ms	6
16.3		> pressure ring MS raw	6
16.4		> o-ring ID.5,0x2,0 NBR70	6
16.5		> washer A5,3 DIN125 A4	12
16.6		> lock washer 5 DIN7980 A4	18
16.7		> nut M5 DIN934 Ms	18

17		o-ring ID.65,0x3,0 Viton	1
18		screw M6x20 ISO4017 A2-70	3
19		screw M6x25 DIN939 A2-70	1
20		nut M6 DIN934 A4-80	2
21		lock washer 6 DIN7980 A4	1
22		washer A6,4 DIN125 A4	2
23		washer A6,4 DIN125 A4	3
24	6023487	stator F17-2/15 400/690 50Hz	1
		alternativ / alternative / alternative	
24	6023506	stator F17-2/15 230 50Hz	1
24	6023509	stator F17-2/15 500 50Hz VN01	1
24	6064205	stator F17-2/15 500 50Hz VN01 Bi 100	1
25	6004661	circlips 174x2 54.1637 FSt	1
26	6035808	safety bar D.5x140 54.19444 St	1
27	6009989	rotor D.89,3x371 2/15 1.4021	1
29	6078164	ball bearing 6206 DDU C3 VP.	1
30	501355698	CIRCLIP 30X1,5 DIN471 FST	1
31	6001374	bearing housing U 51.1699 AI KIT	1
31.1		> bearing housing U 51.1699 AI	1
31.2	6067638	> screw plug G1/2 DIN908 A4 (3pcs)	1
31.3	6048832	> joint ring A21/26x1,5 DIN7603 PA(10pc)	1
31.4	6076642	> o-ring ID.203,0x3,0 Viton (3pc)	1
		alternativ / alternative / alternative	
31.1	6013940	bearing housing U 51.1699 AI/C0	1
31.1	6019019	bearing housing U 51.1699 AI/C1	1

CONTRACTOR'S PUMP KS70ZN UNIT (6000111)

Item	Article no.	Description	Quantity
32	6008974	ball bearing 6306	1
30	501355698	CIRCLIP 30X1,5 DIN471 FST	1
33	6009373	pressure ring D.72/39,2x19,1 55.1689 GG	1
34		o-ring ID.65,0x3,0 Viton	1
35	6077844	mech.seal MG1/30-G60-E1AQ1PGG VP. alternativ / alternative / alternative	1
35	6074586	GRD. MG1/30-G4 Q1Q1VGG VP.	1
30	501355698	CIRCLIP 30X1,5 DIN471 FST	1
36	6074586	GRD. MG1/30-G4 Q1Q1VGG VP.	1
37	6002123	washer D.44/20x1 1.4301 -	1
38	6001372	sealing casing 52.1698/1 Al KIT	1
38.1		> sealing casing D.205g6 52.1698/1 Al	1
38.2	6076642	> o-ring ID.203,0x3,0 Viton (3pc) alternativ / alternative / alternative	1
38.1	6013727	sealing casing D.205 52.1698/1 Al/CO	1
39	6075378	wear plate 53.1693 Neoprene VP. Laufrad / Impeller / Roue 50Hz	1
40	6014080	impeller-M D.154 53.1273 GGG alternativ / alternative / alternative	1
40	6014078	impeller-M D.154 53.1273 GGG/CO	1
40	6010630	impeller-M D.154 53.17904 Abrasit	1
40	6022785	impeller-M D.154 53.17904 Abrasit/CO	1
40	6014079	impeller-M D.154 53.1273 1.4581 Laufrad / Impeller / Roue 60Hz	1
40	6014074	impeller-M D.142 53.1128 GGG alternativ / alternative / alternative	1
40	6021695	impeller-M D.142 53.1128 GGG/CO	1
40	6024441	impeller-M D.142 53.17904 Abrasit	1
40	6022784	impeller-M D.142 53.17904 Abrasit/CO	1
40	6021645	impeller-M D.142 53.1128 1.4581	1
41	6043597	impeller fixation 55.5399/1 1.4021 KIT	1
41.1		> washer D.26/9x13 55.5399/1	1
41.2	6003416	> screw M8x25 DIN912 10.9 Geomet	1
41.3	6002688	> screw locking Nord-Lock 13,5/8,7 A4	1

CONTRACTOR'S PUMP KS70ZN UNIT (6000111)

Item	Article no.	Description	Quantity
41.4	6004654	> key A 6x4x18 54.2589 A4	1
44	6001370	pump housing A 51.1702 GG KIT	1
44.1		> pump housing A 51.1702 GG	1
44.2		> o-ring ID.270,0x3,0 Viton	1
44.1.1	6073152	neck ring D.105x13 6051846 1.4470 VP. alternativ / alternative / alternative	1
44.1	6012861	pump housing A 51.1702 GG/CO	1
44.1	6012830	pump housing A 51.1702 GG/C1C1	1
44.1	6012845	pump housing A 51.1702 GG/C2C1	1
44.1	6012909	pump housing A 51.16785 1.4581	1
44.1	6022771	pump housing A 51.19190 Abrasit	1
44.1	6022779	pump housing A 53.19190 Abrasit/CO	1
45	6001371	strainer 53.17962 1.4301 KIT	1
45.1		> strainer 57x273x2 53.17962 1.4301	1
45.2		> base plate D.284 52.17961 Al	1
45.3		> screw M10x35 DIN933 A2-70 alternativ / alternative / alternative	4
45.1	6013069	strainer 57x273x2 53.17962 1.4301/CO	1

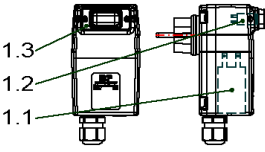
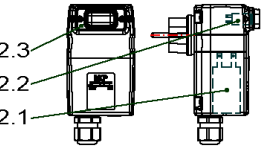
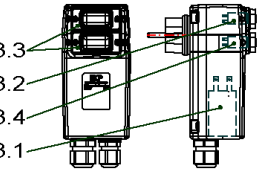
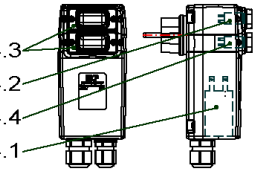
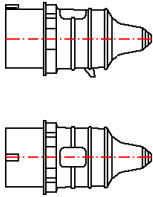
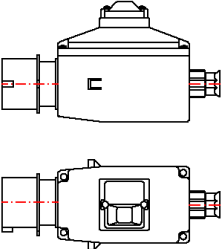
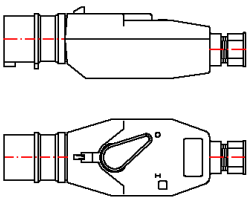
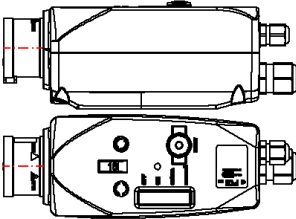
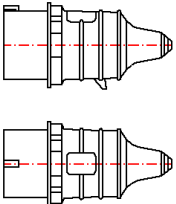
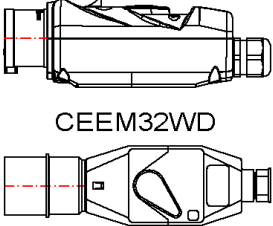
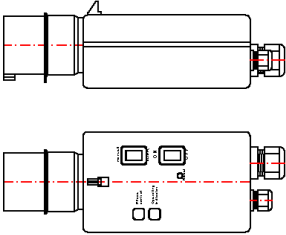
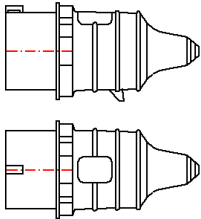
<p>1 MCP 6A-M-H-20μF ~ 230V</p>  <p>$I_N(230V / 50Hz) < 6A = 20\mu F$</p>	<p>2 MCP 10A-M-H-30μF ~ 230V</p>  <p>$I_N(230V / 50Hz) 6-10A = 30\mu F$</p>	<p>3 MCP 6A-M-HA-20μF ~ 230V</p>  <p>$I_N(230V / 50Hz) < 6A = 20\mu F$</p>	<p>4 MCP 10A-M-HA-30μF ~ 230V</p>  <p>$I_N(230V / 50Hz) 6-10A = 30\mu F$</p>
<p>5 CEE16A</p> 	<p>6 CEEM16W</p> 	<p>7 CEEM16WD</p> 	<p>8 MCP T4-HA-ROT-WSK CEE16-5PS</p> 
<p>9 CEE32A</p> 	<p>10 MCP 10-16A-T4-H-ROT CEE32-5PS</p>  <p>CEEM32WD</p>	<p>11 CEEM32WDSHA</p> 	<p>12 CEE63A</p> 

PLUG

Item	Article no.	Description	Quantity
		IN (230V / 50Hz) <6A - 20μF	
1	6072332	MCP 6A-M-H-20μF-CEE7/7 VP.	1
1.1	6071702	capacitor 400V 20μF MCP VP.	1
1.2	6071704	protection switch 6A MCP VP.	1
1.3	6071707	protecting cap MCP VP.	1
		IN (230V / 50Hz) 6-10A - 30μF	
2	6072330	MCP 10A-M-H-30μF-CEE7/7 VP.	1
2.1	6071703	capacitor 400V 30μF MCP VP.	1
2.2	6071705	protection switch 10A MCP VP.	1
2.3	6071707	protecting cap MCP VP.	1
		IN (230V / 50Hz) <6A - 20μF	
3	6072331	MCP 6A-M-HA-20μF-CEE7/7 VP.	1
3.1	6071702	capacitor 400V 20μF MCP VP.	1
3.2	6071704	protection switch 6A MCP VP.	1
3.3	6071707	protecting cap MCP VP.	2
3.4	6071706	switch on/out MCP VP.	1
		IN (230V / 50Hz) 6-10A - 30μF	
4	6072329	MCP 10A-M-HA-30μF-CEE7/7 VP	1
4.1	6071703	capacitor 400V 30μF MCP VP.	1
4.2	6071705	protection switch 10A MCP VP.	1
4.3	6071707	protecting cap MCP VP.	2
4.4	6071706	switch on/out MCP VP.	1
5	6003000	plug CEE16A/400V 60Hz/5P-11h	1
5	6003248	plug CEE16A/400V/4P-6H	1
5	6003009	plug CEE16A/400V/5P-6H	1
5	6039156	plug CEE16A/400V/5P-6H Phase inverter	1
5	6035231	plug CEE16A/400V/7P-6H	1
5	6003011	plug CEE16A/500V/5P-7H	1
6	6030883	plug MS400V5P CEE16A W 1,0-1,6A	1
6	6030884	plug MS400V5P CEE16A W 1,6-2,5A	1
6	6030888	plug MS400V5P CEE16A W 10,0-16,0A	1
6	6030885	plug MS400V5P CEE16A W 2,5-4,0A	1
6	6030886	plug MS400V5P CEE16A W 4,0-6,3A	1
6	6030887	plug MS400V5P CEE16A W 6,3-10,0A	1

PLUG

Item	Article no.	Description	Quantity
7	6032446	plug MS400V4P CEE16A WD 1,6-2,5A	1
7	6032447	plug MS400V4P CEE16A WD 12,5-16,0A	1
7	6032295	plug MS400V4P CEE16A WD 2,5-4,0A	1
7	6032289	plug MS400V4P CEE16A WD 4,0-6,3A	1
7	6032292	plug MS400V4P CEE16A WD 6,3-9,0A	1
7	6042190	plug MS400V5P CEE16A WDII 1,6-2,5A	1
7	6042194	plug MS400V5P CEE16A WDII 10,0-16,0A	1
7	6042191	plug MS400V5P CEE16A WDII 2,5-4,0A	1
7	6042192	plug MS400V5P CEE16A WDII 4,0-6,3A	1
7	6042193	plug MS400V5P CEE16A WDII 6,3-10,0A	1
7	6035911	plug MS400V5P CEE16A WD 9,0-12,5A	1
7	6003337	plug MS500V5P CEE16A WD 1,6-2,5A	1
7	6003336	plug MS500V5P CEE16A WD 2,5-4,0A	1
7	6003335	plug MS500V5P CEE16A WD 4,0-6,3A	1
7	6003334	plug MS500V5P CEE16A WD 6,3-9,0A	1
8	6072520	MCP 1,0-1,6A-T4-HA-ROT-WSK-CEE16-5PS VP.	1
8	6072521	MCP 1,6-2,4A-T4-HA-ROT-WSK-CEE16-5PS VP.	1
8	6072522	MCP 2,4-4,0A-T4-HA-ROT-WSK-CEE16-5PS VP.	1
8	6072523	MCP 4,0-6,0A-T4-HA-ROT-WSK-CEE16-5PS VP.	1
8	6072524	MCP 6,0-10A-T4-HA-ROT-WSK-CEE16-5PS VP.	1
8	6072525	MCP 9,0-12A-T4-HA-ROT-WSK-CEE16-5PS VP.	1
8	6072526	MCP 12-16A-T4-HA-ROT-WSK-CEE16-5PS VP.	1
9	6003267	plug CEE32A/400V/4P-6H	1
9	6039155	plug CEE32A/400V/5P-6H Phase inverter	1
9	6035895	plug CEE32A/500V/4P-7H AM-Top	1
9	6003010	plug CEE32A/500V/5P-7H	1
10	6072370	MCP 400V 1,6-2,5A-T4-H-ROT-CEE32-5PS VP.	1
10	6072369	MCP 400V 2,5-4,0A-T4-H-ROT-CEE32-5PS VP.	1
10	6072371	MCP 400V 4,0-6,3A-T4-H-ROT-CEE32-5PS VP.	1
10	6072398	MCP 400V 6,3-10A-T4-H-ROT-CEE32-5PS VP.	1
10	6072519	MCP 400V 10-16A-T4-H-ROT-CEE32-5PS VP.	1
10	6072399	MCP 400V 16-20A-T4-H-ROT-CEE32-5PS VP.	1
10	6072518	MCP 400V 20-25A-T4-H-ROT-CEE32-5PS VP.	1
10	6037649	plug.MS500V4P CEE32A WD 2,5-4,0A	1

PLUG

Item	Article no.	Description	Quantity
10	6041268	plug MS500V4P CEE32A WD 4,0-6,3A	1
10	6035244	plug MS500V5P CEE32A WD 1,6-2,5A	1
10	6034700	plug MS500V5P CEE32A WD 2,5-4,0A	1
10	6041556	plug MS500V5P CEE32A WD 4,0-6,3A	1
10	6002701	plug MS500V5P CEE32A WD 9,0-12,5A	1
10	6002700	plug MS500V5P CEE32A WD 12,5-16,0A	1
11	6003241	plug MS400V5P CEE32A WDSHA 10,0-14,0A	1
11	6003266	plug MS400V5P CEE32A WDSHA 3,7-5,5A	1
11	6003265	plug MS400V5P CEE32A WDSHA 5,5-8,0A	1
11	6003264	plug MS400V5P CEE32A WDSHA 8,0-11,5A	1
12	6003012	plug CEE63A/400V/5P-6H/IP67	1

KS220N

Bm0

S/N < 650118681

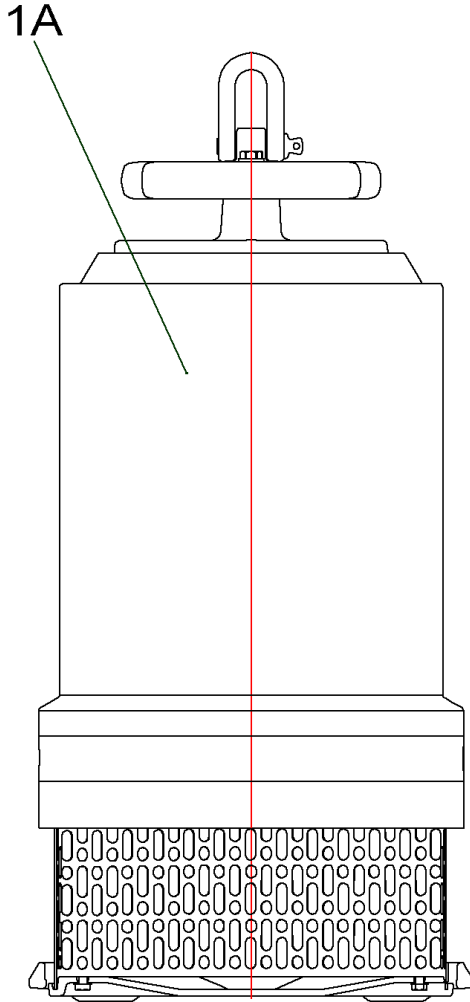

Bm1

S/N > 650118682

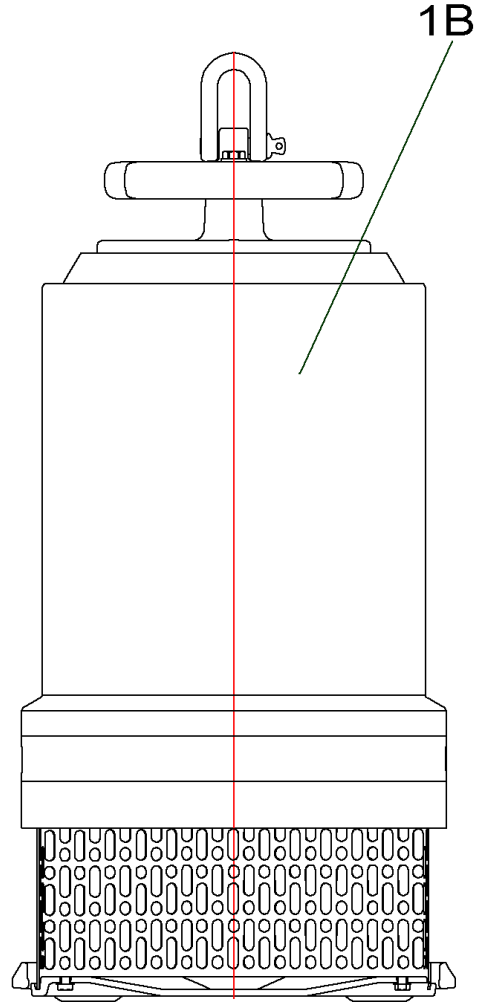

CONTRACTOR'S PUMP KS220N UNIT (6000094)

Item	Description	Quantity
1A	CONTRACTOR'S PUMP KS220N (Bm0)	1
1B	CONTRACTOR'S PUMP KS220N (Bm1)	1

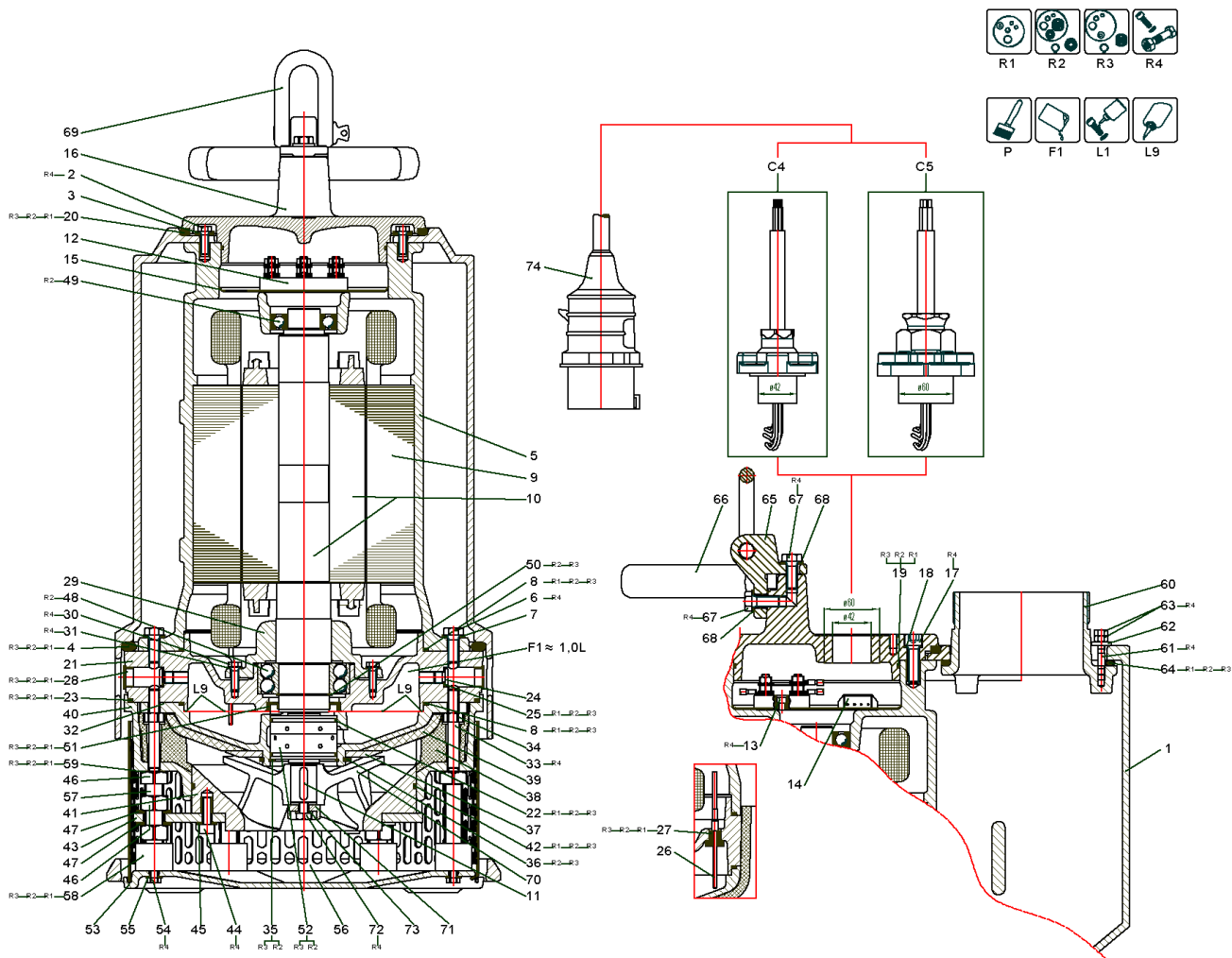

CONTRACTOR'S PUMP KS220N (Bm0)

Item	Article no.	Description	Quantity
R1	6016273	Rep.Kit 1 KS220 Vit	1
R2	6016288	Rep.Kit 2 KS220 Vit	1
R3	6016321	Rep.Kit 3 KS220 Vit	1
R4	6016127	Screws KS220 KIT	1
P	6042254	PAINT SPRAY Pantone334	1
P	6042255	colour 2K-paint IV80 pantone334C 250ml	1
P	6023614	Ceram C0 black 100 ml KIT	1
P	6020579	Ceram C0 black 250 ml KIT	1
P	6023485	Ceram C0 Black 500ml Kit	1
P	6019157	Ceram C0 black 1000 ml KIT	1
F1	6025460	medical white oil 1L KIT	1
F1	6025461	medical white oil 5L KIT	1
L1	6080531	Loctite 243 5g flask VP:	1
L1	2096167	Loctite 243 50ml VP.	1
L9	6080535	Loctite 5203 300ml VP.	1

C5		cable trumpet 60T KIT	1
C4		cable trumpet 42T KIT	2

1	6017268	pump shroud SG6 50.17861 Al/C0 alternativ / alternative / alternative	1
1	6032053	pump shroud SG6 50.17861 3.1371.61/C0	1
2		screw M8x25 DIN933 A4-70 (10pc)	1
3		washer 8,4 DIN7349 A4 (10pc)	1
4		o-ring ID.360,0x15,0 NBR55	1
5		motor casing 51.17863 Al	1
Note: auf Anfrage / on request / sur demande			
6		screw M12x30 DIN933 A4-70	6
7		washer A13 DIN125 A4 (20pc)	1
8		o-ring ID.255,0x4,0 Viton	1
9	6081415	Stator T24-2/21 400/690 50 PTC110° VP.	1
10	6010512	rotor D.133,5x537 2/21 1.4021 alternativ / alternative / alternative	1
10	6042221	rotor D.133,5x537 2/21 4021/4462 g	1

CONTRACTOR'S PUMP KS220N (Bm0)

Item	Article no.	Description	Quantity
11	6076643	key A 8x5x36 DIN6885 A4 VP.	1
12	6070362	terminal board 6pol. konf.	1
13		screw M6x16 DIN912 A4 (10pc)	1
14	6002712	connectors pin strip 4-polig	1
15	6010193	cover disc D.182 54.18083 MVL-UE 1x Ø 60mm gebohrt / drilled / percé	1
16	6010758	motor cover D.60 51.17865 GG/C0 2xØ 42mm gebohrt / drilled / percé	1
16	6010757	motor cover D.42 51.17865 GG/C0	1
17		screw M12x40 DIN912 A4-70 (10pc)	1
18		lock washer 12 DIN7980 A4	4
19		o-ring ID.170,0x3,0 NBR70	1
20		o-ring ID.250,0x8,0 NBR70	1
21	6010652	bearing housing 51.17867 GG/C0	1
8		o-ring ID.255,0x4,0 Viton	1
23		O-Ring ID.360,0x4,0 Viton 75 VP.	1
24	6002435	screw plug G1/4 A DIN908 A4	2
25	6007522	seal ring A14/18x1,5 DIN7603 PA	2
26	6017145	electrode rod D.4x77 54.13422 A2	2
27	6078171	sealing plug 13421 NBR 80 VP.	2
28	6007419	plug GPN300 F19 Plastik	2
29	6010648	bearing cover D.110H7 52.17868 Al	1
30		screw M8x25 DIN933 A4-70 (10pc)	1
31		washer A8,4 DIN125 1.4401 (20pc)	1
32	6010622	sealing flange D.355 51.17870 Al/C0	1
33		screw M12x85 DIN939 A2-70	6
34		nut M12 DIN934 A4-80 (10pcs)	1
35	6002185	circlips 72x2,5 DIN472 A2	1
36	6002053	circlips 90x3 DIN471 A2	1
37	6016948	washer D.90/170x7 54.18086 1.4301	1
38	6004315	guide casing 17872 PUR raw	1
39	6004703	wear plate 17873 PUR raw	1
40	6010927	pump housing A 51.17874 Al/C0	1
41	6010654	suction port D.244 52.17877 PA12G	1

CONTRACTOR'S PUMP KS220N (Bm0)

Item	Article no.	Description	Quantity
42		o-ring ID.230,0x4,0 NBR70	1
43	6004347	supporting plate 53.18082 1.4301	1
44		screw M10x30 ISO4762 A4-70	3
45		Washer A10,5 DIN125 A4 (20pcs)	1
46		nut M20 DIN934 A4-80 (10pc)	1
47		WASHER A21 DIN125 A4 (10pc)	1
48	6081300	ball bearing 5211 VP.	1
49	6081345	ball bearing 6207 w.2 Dichtschr. VP.	1
50	6081303	Circlip 55x2 DIN471 FSt VP.	1
51	6007473	shaft seal ring B55/80x10 Domsel NBR+A2	1
52	6074592	shaft sealing H35/2 VP.	1
		alternativ / alternative / alternative	
52	6075005	shaft sealing H35/2 1.4462 VP.	1
22	6080478	o-ring ID.65,0x3,0 Viton molyk.70 (2pc)	1
53	6017267	base plate D.392 51.17882 Al/C0	1
54		screw M8x16 DIN933 A4-70	6
55		washer A8,4 DIN125 1.4401 (20pc)	1
56	6004875	strainer 175x380x2 51.17883 1.4301	1
57	6010755	spacer M20x65 DIN933 54.17884 A4	6
58	6002685	rubber buffer Tiegler B/GM40 NB	6
59		Dubo-washer M12 NR.207 PA	6
60	6010756	discharge piece G6 52.17885 GGG/C0	1
61		screw M8x40 DIN939 A4	4
62		washer 8,4 DIN7349 A4 (10pc)	1
63		nut M8 DIN934 A4	8
64		O-RING ID.184X8N DIN3771 NBR70	1
65	6017259	handle 52.17887 1.4581	1
66	6003986	handle 52.17333 St-Gummi	1
67		screw M12x30 DIN933 A4-70	2
68		washer A13 DIN125 A4 (20pc)	1
69	6003030	shackle 16mm 1.4401	1
		Laufrad / Impeller / Roue 50Hz	
70	6017861	impeller-N/MN D.175 52.17969 Abrasit	1
		Laufrad / Impeller / Roue 60Hz	

CONTRACTOR'S PUMP KS220N (Bm0)

Item	Article no.	Description	Quantity
70	6021655	impeller-N/MN D.162 52.17969 Abrasit	1
71	6011711	washer D.35/11x16 55.1865 1.4021	1
		alternativ / alternative / alternative	
71	6011710	washer D.35/11x16 55.1865 1.4462	1
72	6003623	screw M10x30 DIN933 10.9 Geomet	1
73	2043863	SCREW LOCKING NORD-LOCK 16/10,7 A4	1
74	6003012	plug CEE63A/400V/5P-6H/IP67	1

cablE trumpet 60T KIT

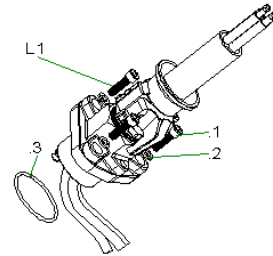
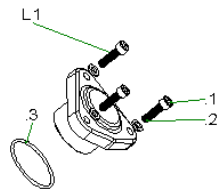
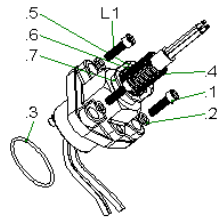
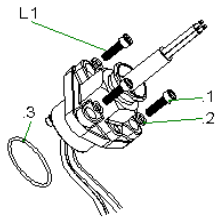

cable trumpet 60T KIT

Item	Article no.	Description	Quantity
L1	6080531	Loctite 243 5g flask VP:	1
.1	6078159	screw M8x30 DIN912 A4-70 (10pc)	3
.2	6078161	shim ring 8x14x1,0 DIN988 A2 (10pc)	3
.3	6007747	o-ring ID.60,0x3,0 NBR70	1
.4	6062009	protecting cover 42,5/35,5 PA6	
.5	6017168	screw cap D.29 54.13974 1.4401	1
.6	6078163	o-ring ID.20,0x3,0 Viton 75 (3pc)	1
.7	6017170	screwed hose connection Pg29 55.13614 1.	1
1	6001513	cable trumpet 60T 20m H07 4x1,5 KIT	1
1	6001535	cable trumpet 60T 10m H07 10x1,5 KIT	1
2	6035224	cable trumpet 60T 20m S07RN-F 4G6(4x1)	1
2	6045369	cable trumpet 60T 50m S07RN-F 4G6(4x1)	1
3	6001346	cable trumpet 60T 5m NSS 4x1,5 KIT	1
3	6001347	cable trumpet 60T 10m NSS 4x1,5 KIT	1
3	6001348	cable trumpet 60T 15m NSS 4x1,5 KIT	1
3	6001349	cable trumpet 60T 20m NSS 4x1,5 KIT	1
3	6001354	cable trumpet 60T 5m NSS 4x2,5 KIT	1
3	6001355	cable trumpet 60T 10m NSS 4x2,5 KIT	1
3	6001356	cable trumpet 60T 15m NSS 4x2,5 KIT	1
3	6001357	cable trumpet 60T 20m NSS 4x2,5 KIT	1
3	6001358	cable trumpet 60T 5m NSS 4x4 KIT	1
3	6001359	cable trumpet 60T 10m NSS 4x4 KIT	1
3	6001360	Cable Trumpet 60T 15m NSS 4x4 KIT	1
3	6001361	cable trumpet 60T 20m NSS 4x4 KIT	1
3	6042246	cable trumpet 60T 25m NSS 4x4 KIT	1
3	6001482	cable trumpet 60T 5m NSS 4x6 KIT	1
3	6001483	Leitungsdurchf. 60T 10m NSS 4x6 SET	1
3	6001484	cable trumpet 60T 15M NSS 4x6 KIT	1
3	6001485	cable trumpet 60T 20m NSS 4x6 KIT	1
3	6001486	cable trumpet 60T 5m NSS 4x10 KIT	1
3	6001487	cable trumpet 60T 10M NSS 4x10 KIT	1
3	6001488	cable trumpet 60T 15m NSS 4x10 KIT	1
3	6001489	cable trumpet 60T 20m NSS 4x10 KIT	1
3	6001364	cable trumpet 60T 5m NSS 7x1,5 KIT	1

cable trumpet 60T KIT

Item	Article no.	Description	Quantity
3	6001365	cable trumpet 60T 10m NSS 7x1,5 KIT	1
3	6001366	cable trumpet 60T 15m NSS 7x1,5 KIT	1
3	6001367	cable trumpet 60T 20m NSS 7x1,5 KIT	1
3	6001335	cable trumpet 60T 5m NSS 7x2,5 KIT	1
3	6001334	cable trumpet 60T 10m NSS 7x2,5 KIT	1
3	6001336	cable trumpet 60T 15m NSS 7x2,5 KIT	1
3	6001337	cable trumpet 60T 20m NSS 7x2,5 KIT	1
3	6020377	cable trumpet 60T 25m NSS 7x2,5 KIT	1
3	6038669	cable trumpet 60T 50m NSS 7x2,5 KIT	1
3	6001368	cable trumpet 60T 5m NSS 10x1,5 KIT	1
3	6001369	cable trumpet 60T 10m NSS 10x1,5 KIT	1
3	6001480	cable trumpet 60T 15m NSS 10x1,5 KIT	1
3	6001481	cable trumpet 60T 20m NSS 10x1,5 KIT	1
4	6070013	cable trumpet 60T 15m NSSHC 3x16+3x2,5	1
6	6067482	cable trumpet 60T 10m NSS 4x10 C KIT	1
6	6039693	cable trumpet 60T 10m NSS 7x2,5 C KIT	1
7	6081596	cable trumpet 60T 10m S07RC4N-F 4G4	1
7	6085233	cable trumpet 60T 15m S07RC4N-F 4G4	1
7	6026674	cable trumpet 60T 20m S07RC4N-F 4G4	1
7	6066387	cable trumpet 60T 10m S07RC4N8-F 4G16	1
7	6061984	cable trumpet 60T 15m S07RC4N8-F 4G16	1
7	6063564	cable trumpet 60T 40m S07RC4N8-F 4G16	1
7	6085234	cable trumpet 60T 15m S07RC4N8-F 4G25	1
9	6001490	cable trumpet 60T 5m NSS 4x16 KIT	1
9	6001491	cable trumpet 60T 10m NSS 4x16 KIT	1
9	6001492	cable trumpet 60T 15m NSS 4x16 KIT	1
9	6001493	cable trumpet 60T 20m NSS 4x16 KIT	1
9	6021510	cable trumpet 60T 30m NSS 4x16 KIT	1
9	6042287	cable trumpet 60T 60m NSS 4x16 KIT	1
9	6001494	cable trumpet 60T 5m NSS 4x25 KIT	1
9	6001495	cable trumpet 60T 10m NSS 4x25 KIT	1
9	6001496	cable trumpet 60T 15m NSS 4x25 KIT	1
9	6001497	cable trumpet 60T 20m NSS 4x25 KIT	1
9	6034270	cable trumpet 60T 30m NSS 4x25 KIT	1

cable trumpet 60T KIT

Item	Article no.	Description	Quantity
9	6070758	cable trumpet 60T 40m NSS 4x25 KIT	1
10	6065154	cable trumpet 60T 10m 4* AWG4	1
10	6065155	cable trumpet 60T 20m 4* AWG4	1
11	6044718	plug 60T KIT	1

cablE trumpet 42T KIT

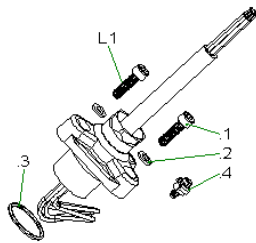

- 1 H07RN-F
- 2 S07RN-F
- 3 NSSHOEU-J
- 4 S07RC4N-F
- 5 SOOW
- 6 NSSHC0U-J

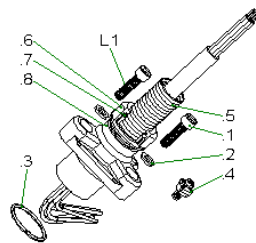

- 7 S07RC4N-F
- 8 H07RN-F
- 9 NSSHOEU-J
- 10 H07RN-F
- 11 NSSHOEU-J

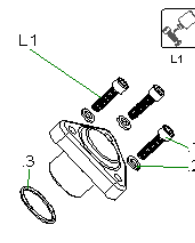

- 12 -----
- 13 NSSHC0U-J
- 14 NSSHOEU-J
- 15 S07RC4N-F
- 16 SOOW

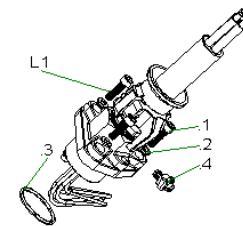

cable trumpet 42T KIT

Item	Article no.	Description	Quantity
L1	6080531	Loctite 243 5g flask VP:	1
.1	6078159	screw M8x30 DIN912 A4-70 (10pc)	3
.2	6078161	shim ring 8x14x1,0 DIN988 A2 (10pc)	3
.3	6078162	o-ring ID.40,0x3,0 Viton (3pc)	1
.4	6067407	Barlian bow terminal M5 A2	1
.5	6007918	protecting hose 28,5/22,8 PA6	
.6	6017168	screw cap D.29 54.13974 1.4401	1
.7	6078163	o-ring ID.20,0x3,0 Viton 75 (3pc)	1
1	6000688	cable trumpet 42T 5m H07 7G1,5 KIT	1
1	6000689	CABLE TRUMPET 42T 10M H07 7G1,5 KIT	1
1	6000690	cable trumpet 42T 15m H07 7G1,5 KIT	1
1	6000691	cable trumpet 42T 20m H07 7G1,5 SET	1
1	6024687	cable trumpet 42T 25m H07 7G1,5 KIT	1
1	6032527	cable trumpet 42T 30m H07 7G1,5 KIT	1
1	6066420	cable trumpet 42T 35m H07 7G1,5 KIT	1
1	6000692	cable trumpet 42T 5m H07 10G1,5 KIT	1
1	6001115	cable trumpet 42T 10m H07 10G1,5 KIT	1
1	6000693	cable trumpet 42T 15m H07 10G1,5 KIT	1
1	6000694	cable trumpet 42T 20m H07 10G1,5 KIT	1
1	6046176	cable trumpet 42T 25m H07 10G1,5 KIT	1
2	6038293	cable trumpet 42T 10m S07RN-F 4G6(4x1)	1
3	6000699	cable trumpet 42T 5m NSS 2x1,5 KIT	1
3	6000700	cable trumpet 42T 10m NSS 2x1,5 KIT	1
3	6000701	cable trumpet 42T 15m NSS 2x1,5 KIT	1
3	6000702	cable trumpet 42T 20m NSS 2x1,5 KIT	1
3	6075910	cable trumpet 42T 25m NSS 2x1,5 KIT	1
3	6061578	cable trumpet 42T 30m NSS 2x1,5 KIT	1
3	6065996	cable trumpet 42T 45m NSS 2x1,5 KIT	1
3	6000703	cable trumpet 42T 5m NSS 4x1,5 KIT	1
3	6000704	cable trumpet 42T 10m NSS 4x1,5 KIT	1
3	6000705	Cable Trumpet 42T 15m NSS 4x1,5 KIT	1
3	6000706	cable trumpet 42T 20m NSS 4x1,5 KIT	1
3	6020376	cable trumpet 42T 25m NSS 4x1,5 KIT	1
3	6019867	cable trumpet 42T 30m NSS 4x1,5 KIT	1

cable trumpet 42T KIT

Item	Article no.	Description	Quantity
3	6036907	cable trumpet 42T 35m NSS 4x1,5 KIT	1
3	6038670	cable trumpet 42T 50m NSS 4x1,5 KIT	1
3	6040496	cable trumpet 42T 60m NSS 4x1,5 KIT	1
3	6000707	cable trumpet 42T 5m NSS 4x2,5 KIT	1
3	6000708	cable trumpet 42T 10m NSS 4x2,5 KIT	1
3	6000709	cable trumpet 42T 15m NSS 4x2,5 KIT	1
3	6001426	cable trumpet 42T 20m NSS 4x2,5 KIT	1
3	6066888	cable trumpet 42T 25m NSS 4x2,5 KIT	1
3	6001427	cable trumpet 42T 5m NSS 4x4 KIT	1
3	6001428	cable trumpet 42T 10m NSS 4x4 KIT	1
3	6001429	cable trumpet 42T 15m NSS 4x4 KIT	1
3	6001430	cable trumpet 42T 20m NSS 4x4 KIT	1
3	6075909	cable trumpet 42T 25m NSS 4x4 KIT	1
3	6067861	cable trumpet 42T 30m NSS 4x4 KIT	1
3	6072786	cable trumpet 42T 10m NSS 4x6 KIT	1
3	6066425	cable trumpet 42T 15m NSS 4x6 KIT	1
3	6068990	cable trumpet 42T 20m NSS 4x6 KIT	1
3	6065995	cable trumpet 42T 30m NSS 4x6 KIT	1
3	6065994	cable trumpet 42T 45m NSS 4x6 KIT	1
3	6040497	cable trumpet 42T 60m NSS 4x6 KIT	1
3	6044835	cable trumpet 42T 10m NSS 4x10 KIT	1
3	6067481	cable trumpet 42T 15m NSS 4x10 KIT	1
3	6070122	cable trumpet 42T 30m NSS 4x10 KIT	1
3	6001431	cable trumpet 42T 5m NSS 7x1,5 KIT	1
3	6001432	cable trumpet 42T 10m NSS 7x1,5 KIT	1
3	6001433	cable trumpet 42T 15m NSS 7x1,5 KIT	1
3	6001434	cable trumpet 42T 20m NSS 7x1,5 KIT	1
3	6040684	cable trumpet 42T 25m NSS 7x1,5 KIT	1
3	6074636	cable trumpet 42T 40m NSS 7x1,5 KIT	1
3	6001435	cable trumpet 42T 5m NSS 7x2,5 KIT	1
3	6001436	cable trumpet 42T 10M NSS 7x2,5 KIT	1
3	6001437	cable trumpet 42T 15m NSS 7x2,5 KIT	1
3	6001438	cable trumpet 42T 20m NSS 7x2,5 KIT	1
3	6036937	cable trumpet 42T 25m NSS 7x2,5 KIT	1

cable trumpet 42T KIT

Item	Article no.	Description	Quantity
3	6036906	cable trumpet 42T 35m NSS 7x2,5 KIT	1
3	6086145	cable trumpet 42T 10m NSS 10x1,5 SET	1
3	6068144	cable trumpet 42T 15m NSS 10x1,5 KIT	1
3	6078651	cable trumpet 42T 20m NSS 10x1,5 SET	1
3	6078807	cable trumpet 42T 25m NSS 10x1,5 SET	1
4	6046317	cable trumpet 42T 10m S07RC4N-F 4x1,5	1
4	6063563	cable trumpet 42T 40m S07RC4N-F 4x1,5	1
4	6066388	cable trumpet 42T 10m S07RC4N-F 7x1,5KIT	1
4	6061983	cable trumpet 42T 15m S07RC4N-F 4x1,5KIT	1
4	6046316	cable trumpet 42T 20m S07RC4N-F 4x4	1
5	6065152	cable trumpet 42T 10m 2* AWG14	1
5	6065153	cable trumpet 42T 20m 2* AWG14	1
5	6066488	cable trumpet 42T 20m 4* AWG14	1
5	6065151	cable trumpet 42T 10m 7* AWG14	1
5	6066489	cable trumpet 42T 20m 7* AWG14	1
5	6065150	cable trumpet 42T 10m 4* AWG10	1
6	2132620	on request	1

7	6067898	cable trumpet 42T 10m S07RC4N-F 12G1,5 C	1
8	6019360	cable trumpet 42T 5m H07 7G1,5 C KIT	1
8	6019362	cable trumpet 42T 15m H07 7G1,5 C KIT	1
9	6037455	cable trumpet 42T 10m NSS 4x1,5 C KIT	1
9	6019374	cable trumpet 42T 15m NSS 4x2,5 C KIT	1
9	6019381	cable trumpet 42T 10m NSS 7x1,5 C KIT	1
9	6019382	cable trumpet 42T 15m NSS 7x1,5 C KIT	1
9	6037454	cable trumpet 42T 10m NSS 7x2,5 C KIT	1
9	6019387	cable trumpet 42T 20m NSS 7x2,5 C KIT	1
9	6079792	cable trumpet 42T 30m NSS 7x2,5 C KIT	1
10	6019849	cable trumpet 42T RF 10m H07 7G1,5 KIT	1
10	6035148	cable trumpet 42T RF 15m H07 7G1,5 KIT	1
10	6038689	cable trumpet 42T RF 20m H07 7G1,5 KIT	1
11	6032612	cable trumpet 42T RF 10m NSS 7x1,5 KIT	1
11	6034277	cable trumpet 42T RF 30m NSS 7x1,5 KIT	1

cable trumpet 42T KIT

Item	Article no.	Description	Quantity
12	6044717	plug 42T KIT	1
13	6070010	cable trumpet 42T 15m NSSHC 3x16+3x2,5	1
14	6044834	cable trumpet 42T 10m NSS 4x16 KIT	1
14	6067480	cable trumpet 42T 15m NSS 4x16 KIT	1
14	6066168	cable trumpet 42T 20m NSS 4x16 KIT	1
14	6069678	cable trumpet 42T 25m NSS 4x16 KIT	1
14	6081974	cable trumpet 42T 40m NSS 4x16 KIT	1
15	6063562	cable trumpet 42T 40m S07RC4N-F 4x16	1
16	6067560	cable trumpet 42T 20m 4* AWG6	1

CONTRACTOR'S PUMP KS220N (Bm1)

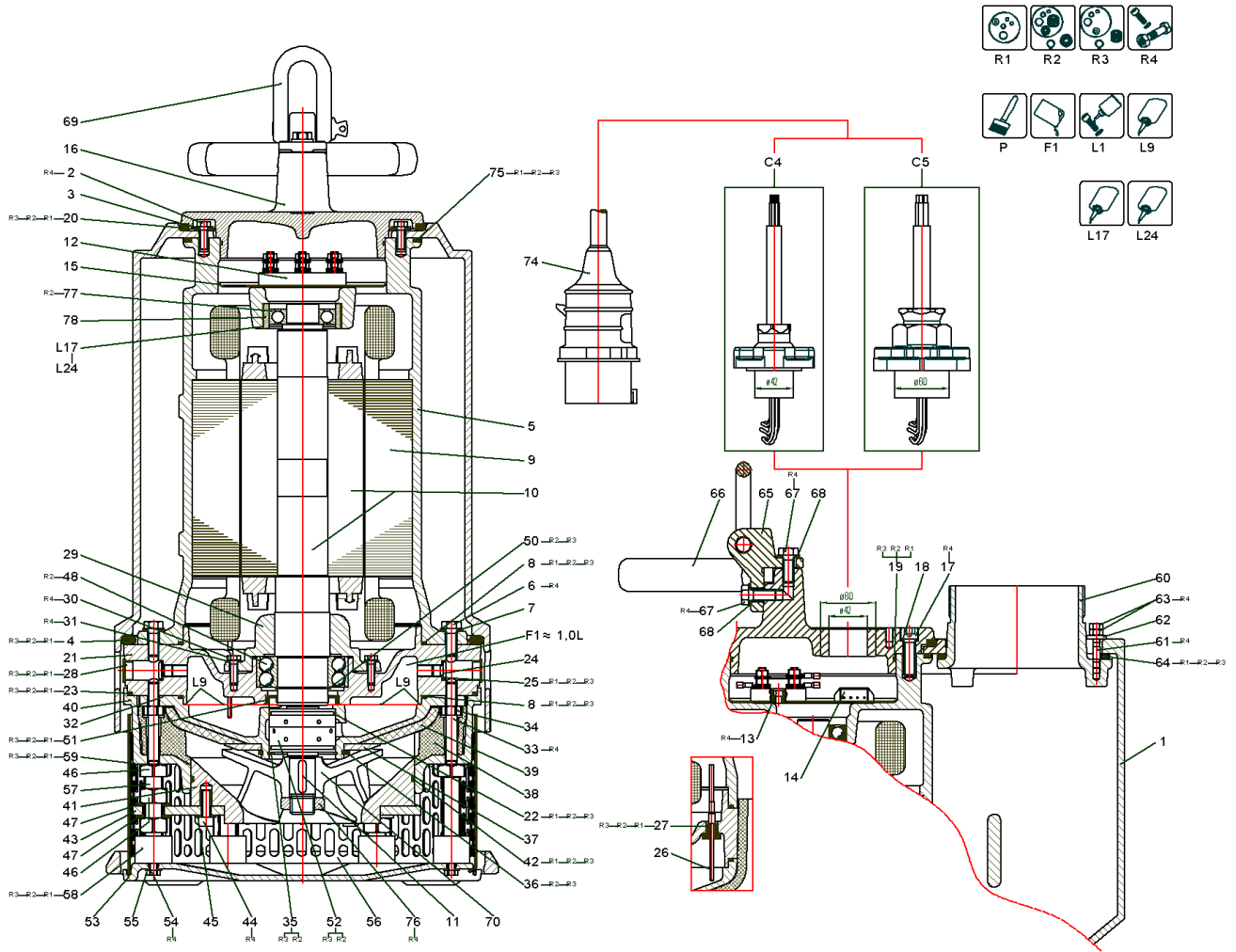

CONTRACTOR'S PUMP KS220N (Bm1)

Item	Article no.	Description	Quantity
R1	6016273	Rep.Kit 1 KS220 Vit	1
R2	6016288	Rep.Kit 2 KS220 Vit	1
R3	6016321	Rep.Kit 3 KS220 Vit	1
R4	6016127	Screws KS220 KIT	1
P	6042254	PAINT SPRAY Pantone334	1
P	6042255	colour 2K-paint IV80 pantone334C 250ml	1
P	6023614	Ceram C0 black 100 ml KIT	1
P	6020579	Ceram C0 black 250 ml KIT	1
P	6023485	Ceram C0 Black 500ml Kit	1
P	6019157	Ceram C0 black 1000 ml KIT	1
F1	6025460	medical white oil 1L KIT	1
F1	6025461	medical white oil 5L KIT	1
L1	6080531	Loctite 243 5g flask VP:	1
L1	2096167	Loctite 243 50ml VP.	1
L9	6080535	Loctite 5203 300ml VP.	1
L17		Loctite 7649 500ml	1
L24	6063947	Loctite 3504 50ml	1

C5		cable trumpet 60T KIT	1
C4		cable trumpet 42T KIT	2

1	6017268	pump shroud SG6 50.17861 Al/C0 alternativ / alternative / alternative	1
1	6032053	pump shroud SG6 50.17861 3.1371.61/C0	1
2		screw M8x25 DIN933 A4-70 (10pc)	1
3		washer 8,4 DIN7349 A4 (10pc)	1
4		o-ring ID.360,0x15,0 NBR55	1
5		motor casing 51.17863/1 Al	1
Note: auf Anfrage / on request / sur demande			
78		bush D.85/71x27 6050391 1.4462	1
Note: auf Anfrage / on request / sur demande			
75	6063517	o-ring ID.242,0x6,0 Viton	1
6		screw M12x30 DIN933 A4-70	6
7		washer A13 DIN125 A4 (20pc)	1

CONTRACTOR'S PUMP KS220N (Bm1)

Item	Article no.	Description	Quantity
8		o-ring ID.255,0x4,0 Viton	1
9	6081415	Stator T24-2/21 400/690 50 PTC110° VP.	1
10	6045397	rotor D.133,5x557 2/21 4021/4462 g	1
		alternativ / alternative / alternative	
10	6045395	rotor D.133,5x557 2/21 4021/4462 g	1
76	6038971	nut M27x2,0 DIN439 A2	1
11	6076643	key A 8x5x36 DIN6885 A4 VP.	1
12	6070362	terminal board 6pol. konf.	1
13		screw M6x16 DIN912 A4 (10pc)	1
14	6002712	connectors pin strip 4-polig	1
15	6010193	cover disc D.182 54.18083 MVL-UE	1
		1x Ø 60mm gebohrt / drilled / percè	
16	6010758	motor cover D.60 51.17865 GG/C0	1
		2xØ 42mm gebohrt / drilled / percè	
16	6010757	motor cover D.42 51.17865 GG/C0	1
17		screw M12x40 DIN912 A4-70 (10pc)	1
18		lock washer 12 DIN7980 A4	4
19		o-ring ID.170,0x3,0 NBR70	1
20		o-ring ID.250,0x8,0 NBR70	1
21	6010652	bearing housing 51.17867 GG/C0	1
8		o-ring ID.255,0x4,0 Viton	1
23		O-Ring ID.360,0x4,0 Viton 75 VP.	1
24	6002435	screw plug G1/4 A DIN908 A4	2
25	6007522	seal ring A14/18x1,5 DIN7603 PA	2
26	6017145	electrode rod D.4x77 54.13422 A2	2
27	6078171	sealing plug 13421 NBR 80 VP.	2
28	6007419	plug GPN300 F19 Plastik	2
29	6010648	bearing cover D.110H7 52.17868 Al	1
30		screw M8x25 DIN933 A4-70 (10pc)	1
31		washer A8,4 DIN125 1.4401 (20pc)	1
32	6010622	sealing flange D.355 51.17870 Al/C0	1
33		screw M12x85 DIN939 A2-70	6
34		nut M12 DIN934 A4-80 (10pcs)	1
35	6002185	circlips 72x2,5 DIN472 A2	1

CONTRACTOR'S PUMP KS220N (Bm1)

Item	Article no.	Description	Quantity
36	6002053	circlips 90x3 DIN471 A2	1
37	6016948	washer D.90/170x7 54.18086 1.4301	1
38	6004315	guide casing 17872 PUR raw	1
39	6004703	wear plate 17873 PUR raw	1
40	6010927	pump housing A 51.17874 Al/C0	1
41	6010654	suction port D.244 52.17877 PA12G	1
42		o-ring ID.230,0x4,0 NBR70	1
43	6004347	supporting plate 53.18082 1.4301	1
44		screw M10x30 ISO4762 A4-70	3
45		Washer A10,5 DIN125 A4 (20pcs)	1
46		nut M20 DIN934 A4-80 (10pc)	1
47		WASHER A21 DIN125 A4 (10pc)	1
48	6081300	ball bearing 5211 VP.	1
77	6081345	ball bearing 6207 w.2 Dichtschr. VP.	1
50	6081303	Circlip 55x2 DIN471 FSt VP.	1
51	6007473	shaft seal ring B55/80x10 Domsel NBR+A2	1
52	6074592	shaft sealing H35/2 VP.	1
		alternativ / alternative / alternative	
52	6075005	shaft sealing H35/2 1.4462 VP.	1
22	6080478	o-ring ID.65,0x3,0 Viton molyk.70 (2pc)	1
53	6017267	base plate D.392 51.17882 Al/C0	1
54		screw M8x16 DIN933 A4-70	6
55		washer A8,4 DIN125 1.4401 (20pc)	1
56	6004875	strainer 175x380x2 51.17883 1.4301	1
57	6010755	spacer M20x65 DIN933 54.17884 A4	6
58	6002685	rubber buffer Tiegler B/GM40 NB	6
59		Dubo-washer M12 NR.207 PA	6
60	6010756	discharge piece G6 52.17885 GGG/C0	1
61		screw M8x40 DIN939 A4	4
62		washer 8,4 DIN7349 A4 (10pc)	1
63		nut M8 DIN934 A4	8
64		O-RING ID.184X8N DIN3771 NBR70	1
65	6017259	handle 52.17887 1.4581	1
66	6003986	handle 52.17333 St-Gummi	1

CONTRACTOR'S PUMP KS220N (Bm1)

Item	Article no.	Description	Quantity
67		screw M12x30 DIN933 A4-70	2
68		washer A13 DIN125 A4 (20pc)	1
69	6003030	shackle 16mm 1.4401	1
		Laufrad / Impeller / Roue 50Hz	
70	6017861	impeller-N/MN D.175 52.17969 Abrasit	1
		Laufrad / Impeller / Roue 60Hz	
70	6021655	impeller-N/MN D.162 52.17969 Abrasit	1
74	6003012	plug CEE63A/400V/5P-6H/IP67	1

cablE trumpet 60T KIT

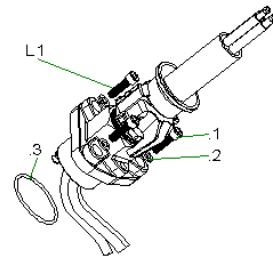
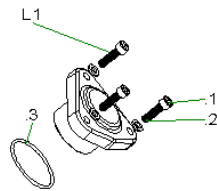
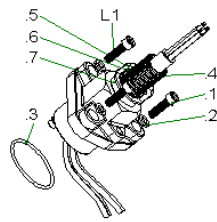
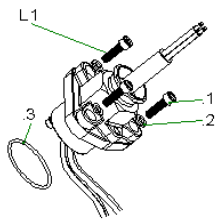

cable trumpet 60T KIT

Item	Article no.	Description	Quantity
L1	6080531	Loctite 243 5g flask VP:	1
.1	6078159	screw M8x30 DIN912 A4-70 (10pc)	3
.2	6078161	shim ring 8x14x1,0 DIN988 A2 (10pc)	3
.3	6007747	o-ring ID.60,0x3,0 NBR70	1
.4	6062009	protecting cover 42,5/35,5 PA6	
.5	6017168	screw cap D.29 54.13974 1.4401	1
.6	6078163	o-ring ID.20,0x3,0 Viton 75 (3pc)	1
.7	6017170	screwed hose connection Pg29 55.13614 1.	1
1	6001513	cable trumpet 60T 20m H07 4x1,5 KIT	1
1	6001535	cable trumpet 60T 10m H07 10x1,5 KIT	1
2	6035224	cable trumpet 60T 20m S07RN-F 4G6(4x1)	1
2	6045369	cable trumpet 60T 50m S07RN-F 4G6(4x1)	1
3	6001346	cable trumpet 60T 5m NSS 4x1,5 KIT	1
3	6001347	cable trumpet 60T 10m NSS 4x1,5 KIT	1
3	6001348	cable trumpet 60T 15m NSS 4x1,5 KIT	1
3	6001349	cable trumpet 60T 20m NSS 4x1,5 KIT	1
3	6001354	cable trumpet 60T 5m NSS 4x2,5 KIT	1
3	6001355	cable trumpet 60T 10m NSS 4x2,5 KIT	1
3	6001356	cable trumpet 60T 15m NSS 4x2,5 KIT	1
3	6001357	cable trumpet 60T 20m NSS 4x2,5 KIT	1
3	6001358	cable trumpet 60T 5m NSS 4x4 KIT	1
3	6001359	cable trumpet 60T 10m NSS 4x4 KIT	1
3	6001360	Cable Trumpet 60T 15m NSS 4x4 KIT	1
3	6001361	cable trumpet 60T 20m NSS 4x4 KIT	1
3	6042246	cable trumpet 60T 25m NSS 4x4 KIT	1
3	6001482	cable trumpet 60T 5m NSS 4x6 KIT	1
3	6001483	Leitungsdurchf. 60T 10m NSS 4x6 SET	1
3	6001484	cable trumpet 60T 15M NSS 4x6 KIT	1
3	6001485	cable trumpet 60T 20m NSS 4x6 KIT	1
3	6001486	cable trumpet 60T 5m NSS 4x10 KIT	1
3	6001487	cable trumpet 60T 10M NSS 4x10 KIT	1
3	6001488	cable trumpet 60T 15m NSS 4x10 KIT	1
3	6001489	cable trumpet 60T 20m NSS 4x10 KIT	1
3	6001364	cable trumpet 60T 5m NSS 7x1,5 KIT	1

cable trumpet 60T KIT

Item	Article no.	Description	Quantity
3	6001365	cable trumpet 60T 10m NSS 7x1,5 KIT	1
3	6001366	cable trumpet 60T 15m NSS 7x1,5 KIT	1
3	6001367	cable trumpet 60T 20m NSS 7x1,5 KIT	1
3	6001335	cable trumpet 60T 5m NSS 7x2,5 KIT	1
3	6001334	cable trumpet 60T 10m NSS 7x2,5 KIT	1
3	6001336	cable trumpet 60T 15m NSS 7x2,5 KIT	1
3	6001337	cable trumpet 60T 20m NSS 7x2,5 KIT	1
3	6020377	cable trumpet 60T 25m NSS 7x2,5 KIT	1
3	6038669	cable trumpet 60T 50m NSS 7x2,5 KIT	1
3	6001368	cable trumpet 60T 5m NSS 10x1,5 KIT	1
3	6001369	cable trumpet 60T 10m NSS 10x1,5 KIT	1
3	6001480	cable trumpet 60T 15m NSS 10x1,5 KIT	1
3	6001481	cable trumpet 60T 20m NSS 10x1,5 KIT	1
4	6070013	cable trumpet 60T 15m NSSHC 3x16+3x2,5	1
6	6067482	cable trumpet 60T 10m NSS 4x10 C KIT	1
6	6039693	cable trumpet 60T 10m NSS 7x2,5 C KIT	1
7	6081596	cable trumpet 60T 10m S07RC4N-F 4G4	1
7	6085233	cable trumpet 60T 15m S07RC4N-F 4G4	1
7	6026674	cable trumpet 60T 20m S07RC4N-F 4G4	1
7	6066387	cable trumpet 60T 10m S07RC4N8-F 4G16	1
7	6061984	cable trumpet 60T 15m S07RC4N8-F 4G16	1
7	6063564	cable trumpet 60T 40m S07RC4N8-F 4G16	1
7	6085234	cable trumpet 60T 15m S07RC4N8-F 4G25	1
9	6001490	cable trumpet 60T 5m NSS 4x16 KIT	1
9	6001491	cable trumpet 60T 10m NSS 4x16 KIT	1
9	6001492	cable trumpet 60T 15m NSS 4x16 KIT	1
9	6001493	cable trumpet 60T 20m NSS 4x16 KIT	1
9	6021510	cable trumpet 60T 30m NSS 4x16 KIT	1
9	6042287	cable trumpet 60T 60m NSS 4x16 KIT	1
9	6001494	cable trumpet 60T 5m NSS 4x25 KIT	1
9	6001495	cable trumpet 60T 10m NSS 4x25 KIT	1
9	6001496	cable trumpet 60T 15m NSS 4x25 KIT	1
9	6001497	cable trumpet 60T 20m NSS 4x25 KIT	1
9	6034270	cable trumpet 60T 30m NSS 4x25 KIT	1

cable trumpet 60T KIT

Item	Article no.	Description	Quantity
9	6070758	cable trumpet 60T 40m NSS 4x25 KIT	1
10	6065154	cable trumpet 60T 10m 4* AWG4	1
10	6065155	cable trumpet 60T 20m 4* AWG4	1
11	6044718	plug 60T KIT	1

cablE trumpet 42T KIT

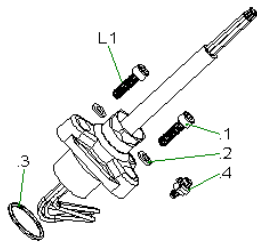

- 1 H07RN-F
- 2 S07RN-F
- 3 NSSHOEU-J
- 4 S07RC4N-F
- 5 SOOW
- 6 NSSHC0U-J

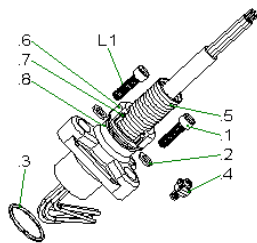

- 7 S07RC4N-F
- 8 H07RN-F
- 9 NSSHOEU-J
- 10 H07RN-F
- 11 NSSHOEU-J

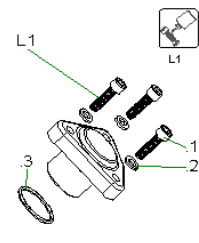

- 12 -----
- 13 NSSHC0U-J
- 14 NSSHOEU-J
- 15 S07RC4N-F
- 16 SOOW

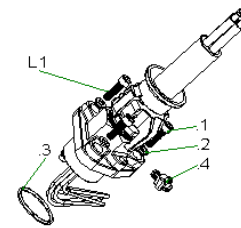

cable trumpet 42T KIT

Item	Article no.	Description	Quantity
L1	6080531	Loctite 243 5g flask VP:	1
.1	6078159	screw M8x30 DIN912 A4-70 (10pc)	3
.2	6078161	shim ring 8x14x1,0 DIN988 A2 (10pc)	3
.3	6078162	o-ring ID.40,0x3,0 Viton (3pc)	1
.4	6067407	Barlian bow terminal M5 A2	1
.5	6007918	protecting hose 28,5/22,8 PA6	
.6	6017168	screw cap D.29 54.13974 1.4401	1
.7	6078163	o-ring ID.20,0x3,0 Viton 75 (3pc)	1
1	6000688	cable trumpet 42T 5m H07 7G1,5 KIT	1
1	6000689	CABLE TRUMPET 42T 10M H07 7G1,5 KIT	1
1	6000690	cable trumpet 42T 15m H07 7G1,5 KIT	1
1	6000691	cable trumpet 42T 20m H07 7G1,5 SET	1
1	6024687	cable trumpet 42T 25m H07 7G1,5 KIT	1
1	6032527	cable trumpet 42T 30m H07 7G1,5 KIT	1
1	6066420	cable trumpet 42T 35m H07 7G1,5 KIT	1
1	6000692	cable trumpet 42T 5m H07 10G1,5 KIT	1
1	6001115	cable trumpet 42T 10m H07 10G1,5 KIT	1
1	6000693	cable trumpet 42T 15m H07 10G1,5 KIT	1
1	6000694	cable trumpet 42T 20m H07 10G1,5 KIT	1
1	6046176	cable trumpet 42T 25m H07 10G1,5 KIT	1
2	6038293	cable trumpet 42T 10m S07RN-F 4G6(4x1)	1
3	6000699	cable trumpet 42T 5m NSS 2x1,5 KIT	1
3	6000700	cable trumpet 42T 10m NSS 2x1,5 KIT	1
3	6000701	cable trumpet 42T 15m NSS 2x1,5 KIT	1
3	6000702	cable trumpet 42T 20m NSS 2x1,5 KIT	1
3	6075910	cable trumpet 42T 25m NSS 2x1,5 KIT	1
3	6061578	cable trumpet 42T 30m NSS 2x1,5 KIT	1
3	6065996	cable trumpet 42T 45m NSS 2x1,5 KIT	1
3	6000703	cable trumpet 42T 5m NSS 4x1,5 KIT	1
3	6000704	cable trumpet 42T 10m NSS 4x1,5 KIT	1
3	6000705	Cable Trumpet 42T 15m NSS 4x1,5 KIT	1
3	6000706	cable trumpet 42T 20m NSS 4x1,5 KIT	1
3	6020376	cable trumpet 42T 25m NSS 4x1,5 KIT	1
3	6019867	cable trumpet 42T 30m NSS 4x1,5 KIT	1

cable trumpet 42T KIT

Item	Article no.	Description	Quantity
3	6036907	cable trumpet 42T 35m NSS 4x1,5 KIT	1
3	6038670	cable trumpet 42T 50m NSS 4x1,5 KIT	1
3	6040496	cable trumpet 42T 60m NSS 4x1,5 KIT	1
3	6000707	cable trumpet 42T 5m NSS 4x2,5 KIT	1
3	6000708	cable trumpet 42T 10m NSS 4x2,5 KIT	1
3	6000709	cable trumpet 42T 15m NSS 4x2,5 KIT	1
3	6001426	cable trumpet 42T 20m NSS 4x2,5 KIT	1
3	6066888	cable trumpet 42T 25m NSS 4x2,5 KIT	1
3	6001427	cable trumpet 42T 5m NSS 4x4 KIT	1
3	6001428	cable trumpet 42T 10m NSS 4x4 KIT	1
3	6001429	cable trumpet 42T 15m NSS 4x4 KIT	1
3	6001430	cable trumpet 42T 20m NSS 4x4 KIT	1
3	6075909	cable trumpet 42T 25m NSS 4x4 KIT	1
3	6067861	cable trumpet 42T 30m NSS 4x4 KIT	1
3	6072786	cable trumpet 42T 10m NSS 4x6 KIT	1
3	6066425	cable trumpet 42T 15m NSS 4x6 KIT	1
3	6068990	cable trumpet 42T 20m NSS 4x6 KIT	1
3	6065995	cable trumpet 42T 30m NSS 4x6 KIT	1
3	6065994	cable trumpet 42T 45m NSS 4x6 KIT	1
3	6040497	cable trumpet 42T 60m NSS 4x6 KIT	1
3	6044835	cable trumpet 42T 10m NSS 4x10 KIT	1
3	6067481	cable trumpet 42T 15m NSS 4x10 KIT	1
3	6070122	cable trumpet 42T 30m NSS 4x10 KIT	1
3	6001431	cable trumpet 42T 5m NSS 7x1,5 KIT	1
3	6001432	cable trumpet 42T 10m NSS 7x1,5 KIT	1
3	6001433	cable trumpet 42T 15m NSS 7x1,5 KIT	1
3	6001434	cable trumpet 42T 20m NSS 7x1,5 KIT	1
3	6040684	cable trumpet 42T 25m NSS 7x1,5 KIT	1
3	6074636	cable trumpet 42T 40m NSS 7x1,5 KIT	1
3	6001435	cable trumpet 42T 5m NSS 7x2,5 KIT	1
3	6001436	cable trumpet 42T 10M NSS 7x2,5 KIT	1
3	6001437	cable trumpet 42T 15m NSS 7x2,5 KIT	1
3	6001438	cable trumpet 42T 20m NSS 7x2,5 KIT	1
3	6036937	cable trumpet 42T 25m NSS 7x2,5 KIT	1

cable trumpet 42T KIT

Item	Article no.	Description	Quantity
3	6036906	cable trumpet 42T 35m NSS 7x2,5 KIT	1
3	6086145	cable trumpet 42T 10m NSS 10x1,5 SET	1
3	6068144	cable trumpet 42T 15m NSS 10x1,5 KIT	1
3	6078651	cable trumpet 42T 20m NSS 10x1,5 SET	1
3	6078807	cable trumpet 42T 25m NSS 10x1,5 SET	1
4	6046317	cable trumpet 42T 10m S07RC4N-F 4x1,5	1
4	6063563	cable trumpet 42T 40m S07RC4N-F 4x1,5	1
4	6066388	cable trumpet 42T 10m S07RC4N-F 7x1,5KIT	1
4	6061983	cable trumpet 42T 15m S07RC4N-F 4x1,5KIT	1
4	6046316	cable trumpet 42T 20m S07RC4N-F 4x4	1
5	6065152	cable trumpet 42T 10m 2* AWG14	1
5	6065153	cable trumpet 42T 20m 2* AWG14	1
5	6066488	cable trumpet 42T 20m 4* AWG14	1
5	6065151	cable trumpet 42T 10m 7* AWG14	1
5	6066489	cable trumpet 42T 20m 7* AWG14	1
5	6065150	cable trumpet 42T 10m 4* AWG10	1
6	2132620	on request	1

7	6067898	cable trumpet 42T 10m S07RC4N-F 12G1,5 C	1
8	6019360	cable trumpet 42T 5m H07 7G1,5 C KIT	1
8	6019362	cable trumpet 42T 15m H07 7G1,5 C KIT	1
9	6037455	cable trumpet 42T 10m NSS 4x1,5 C KIT	1
9	6019374	cable trumpet 42T 15m NSS 4x2,5 C KIT	1
9	6019381	cable trumpet 42T 10m NSS 7x1,5 C KIT	1
9	6019382	cable trumpet 42T 15m NSS 7x1,5 C KIT	1
9	6037454	cable trumpet 42T 10m NSS 7x2,5 C KIT	1
9	6019387	cable trumpet 42T 20m NSS 7x2,5 C KIT	1
9	6079792	cable trumpet 42T 30m NSS 7x2,5 C KIT	1
10	6019849	cable trumpet 42T RF 10m H07 7G1,5 KIT	1
10	6035148	cable trumpet 42T RF 15m H07 7G1,5 KIT	1
10	6038689	cable trumpet 42T RF 20m H07 7G1,5 KIT	1
11	6032612	cable trumpet 42T RF 10m NSS 7x1,5 KIT	1
11	6034277	cable trumpet 42T RF 30m NSS 7x1,5 KIT	1

cable trumpet 42T KIT

Item	Article no.	Description	Quantity
12	6044717	plug 42T KIT	1
13	6070010	cable trumpet 42T 15m NSSHC 3x16+3x2,5	1
14	6044834	cable trumpet 42T 10m NSS 4x16 KIT	1
14	6067480	cable trumpet 42T 15m NSS 4x16 KIT	1
14	6066168	cable trumpet 42T 20m NSS 4x16 KIT	1
14	6069678	cable trumpet 42T 25m NSS 4x16 KIT	1
14	6081974	cable trumpet 42T 40m NSS 4x16 KIT	1
15	6063562	cable trumpet 42T 40m S07RC4N-F 4x16	1
16	6067560	cable trumpet 42T 20m 4* AWG6	1

KS220MN

Bm0

S/N < 650118681

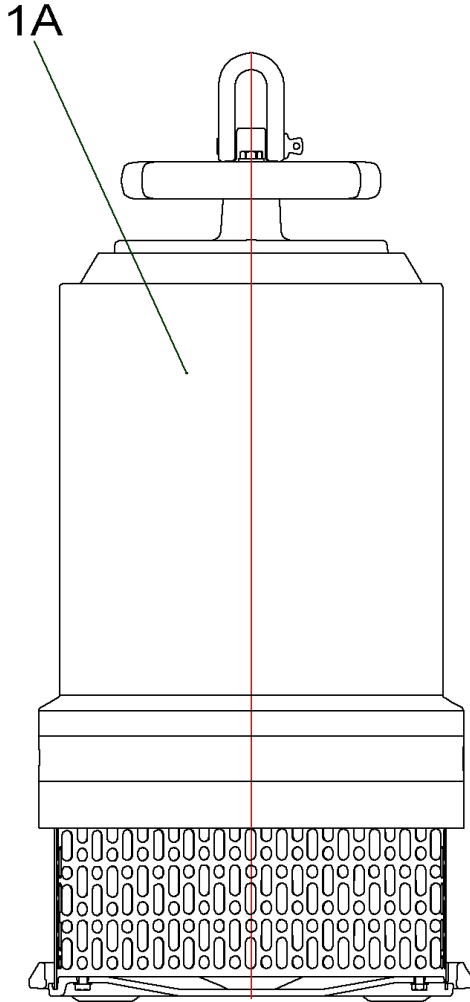

Bm1

S/N > 650118682

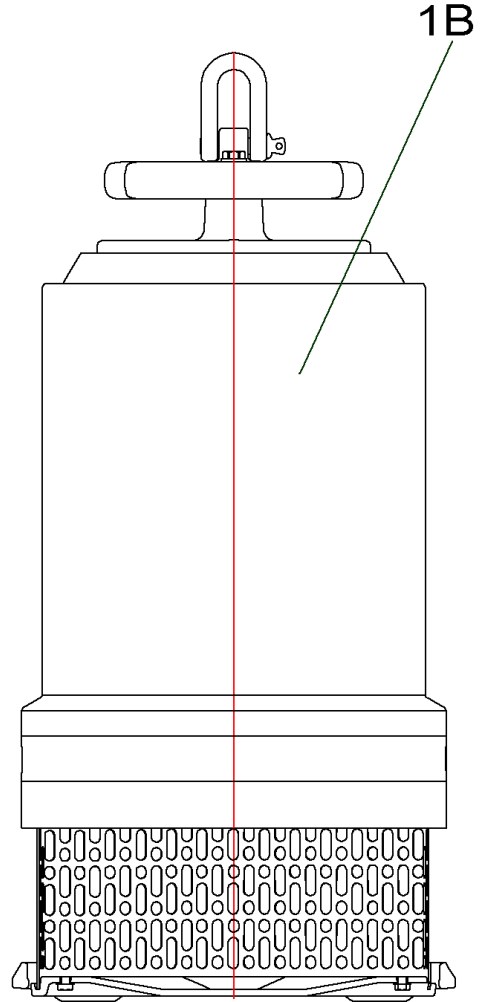

CONTRACTOR'S PUMP KS220MN UNIT (6000093)

Item	Description	Quantity
1A	CONTRACTOR'S PUMP KS220MN (Bm0)	1
1B	CONTRACTOR'S PUMP KS220MN (Bm1)	1

CONTRACTOR'S PUMP KS220MN (Bm0)

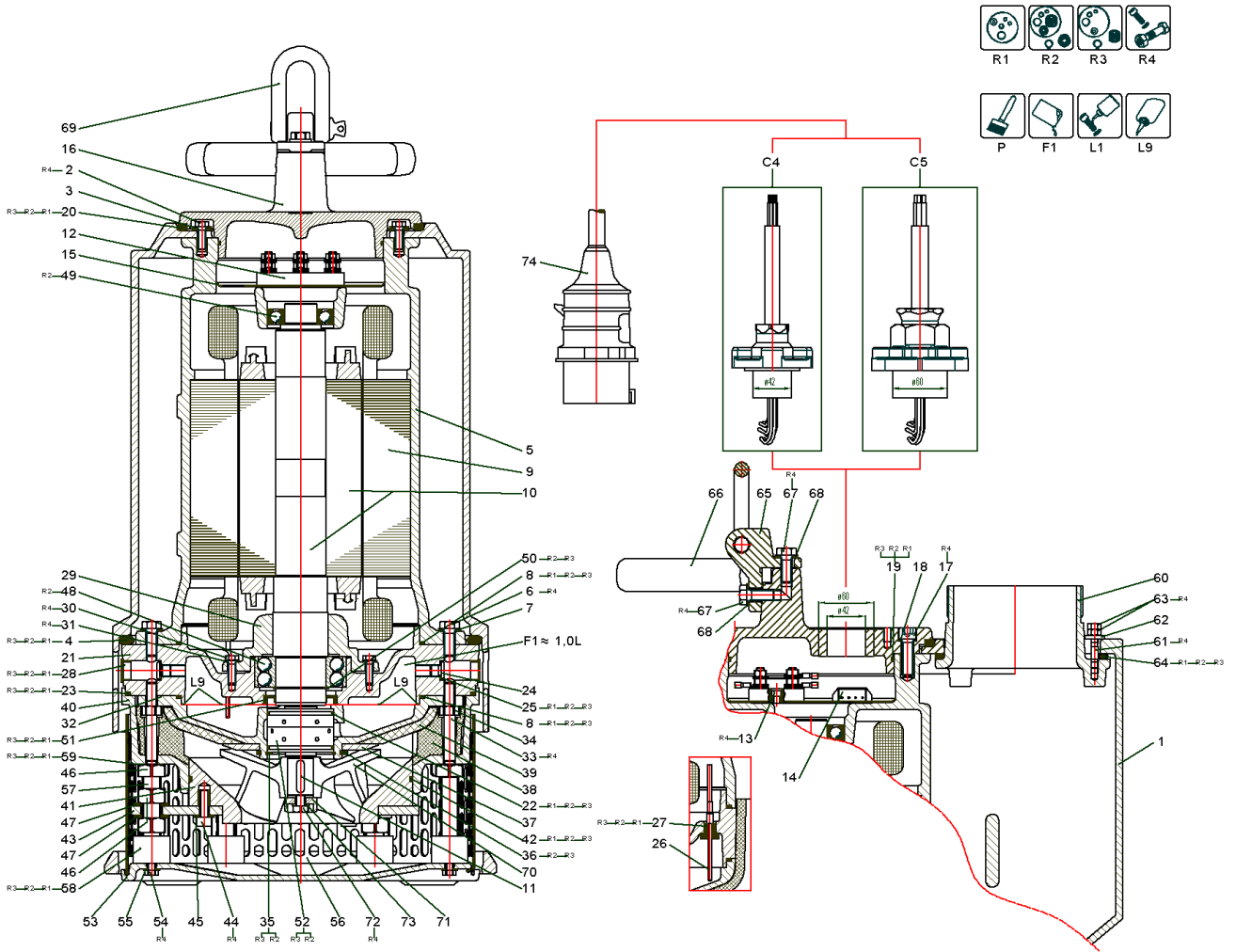

CONTRACTOR'S PUMP KS220MN (Bm0)

Item	Article no.	Description	Quantity
R1	6016273	Rep.Kit 1 KS220 Vit	1
R2	6016288	Rep.Kit 2 KS220 Vit	1
R3	6016321	Rep.Kit 3 KS220 Vit	1
R4	6016127	Screws KS220 KIT	1
P	6042254	PAINT SPRAY Pantone334	1
P	6042255	colour 2K-paint IV80 pantone334C 250ml	1
P	6023614	Ceram C0 black 100 ml KIT	1
P	6020579	Ceram C0 black 250 ml KIT	1
P	6023485	Ceram C0 Black 500ml Kit	1
P	6019157	Ceram C0 black 1000 ml KIT	1
F1	6025460	medical white oil 1L KIT	1
F1	6025461	medical white oil 5L KIT	1
L1	6080531	Loctite 243 5g flask VP:	1
L1	2096167	Loctite 243 50ml VP.	1
L9	6080535	Loctite 5203 300ml VP.	1

C5		cable trumpet 60T KIT	1
C4		cable trumpet 42T KIT	2

1	6017268	pump shroud SG6 50.17861 Al/C0 alternativ / alternative / alternative	1
1	6032053	pump shroud SG6 50.17861 3.1371.61/C0	1
2		screw M8x25 DIN933 A4-70 (10pc)	1
3		washer 8,4 DIN7349 A4 (10pc)	1
4		o-ring ID.360,0x15,0 NBR55	1
5		motor casing 51.17863 Al	1
Note: auf Anfrage / on request / sur demande			
6		screw M12x30 DIN933 A4-70	6
7		washer A13 DIN125 A4 (20pc)	1
8		o-ring ID.255,0x4,0 Viton	1
9	6081415	Stator T24-2/21 400/690 50 PTC110° VP.	1
10	6010512	rotor D.133,5x537 2/21 1.4021 alternativ / alternative / alternative	1
10	6042221	rotor D.133,5x537 2/21 4021/4462 g	1

CONTRACTOR'S PUMP KS220MN (Bm0)

Item	Article no.	Description	Quantity
11	6076643	key A 8x5x36 DIN6885 A4 VP.	1
12	6070362	terminal board 6pol. konf.	1
13		screw M6x16 DIN912 A4 (10pc)	1
14	6002712	connectors pin strip 4-polig	1
15	6010193	cover disc D.182 54.18083 MVL-UE 1x Ø 60mm gebohrt / drilled / percé	1
16	6010758	motor cover D.60 51.17865 GG/C0 2xØ 42mm gebohrt / drilled / percé	1
16	6010757	motor cover D.42 51.17865 GG/C0	1
17		screw M12x40 DIN912 A4-70 (10pc)	1
18		lock washer 12 DIN7980 A4	4
19		o-ring ID.170,0x3,0 NBR70	1
20		o-ring ID.250,0x8,0 NBR70	1
21	6010652	bearing housing 51.17867 GG/C0	1
8		o-ring ID.255,0x4,0 Viton	1
23		O-Ring ID.360,0x4,0 Viton 75 VP.	1
24	6002435	screw plug G1/4 A DIN908 A4	2
25	6007522	seal ring A14/18x1,5 DIN7603 PA	2
26	6017145	electrode rod D.4x77 54.13422 A2	2
27	6078171	sealing plug 13421 NBR 80 VP.	2
28	6007419	plug GPN300 F19 Plastik	2
29	6010648	bearing cover D.110H7 52.17868 Al	1
30		screw M8x25 DIN933 A4-70 (10pc)	1
31		washer A8,4 DIN125 1.4401 (20pc)	1
32	6010622	sealing flange D.355 51.17870 Al/C0	1
33		screw M12x85 DIN939 A2-70	6
34		nut M12 DIN934 A4-80 (10pcs)	1
35	6002185	circlips 72x2,5 DIN472 A2	1
36	6002053	circlips 90x3 DIN471 A2	1
37	6016948	washer D.90/170x7 54.18086 1.4301	1
38	6004316	guide casing 17871 PUR raw	1
39	6004703	wear plate 17873 PUR raw	1
40	6010927	pump housing A 51.17874 Al/C0	1
41	6010654	suction port D.244 52.17877 PA12G	1

CONTRACTOR'S PUMP KS220MN (Bm0)

Item	Article no.	Description	Quantity
42		o-ring ID.230,0x4,0 NBR70	1
43	6016949	supporting plate 52.18084 1.4301	1
44		screw M10x30 ISO4762 A4-70	3
45		Washer A10,5 DIN125 A4 (20pcs)	1
46		nut M20 DIN934 A4-80 (10pc)	1
47		WASHER A21 DIN125 A4 (10pc)	1
48	6081300	ball bearing 5211 VP.	1
49	6081345	ball bearing 6207 w.2 Dichtschr. VP.	1
50	6081303	Circlip 55x2 DIN471 FSt VP.	1
51	6007473	shaft seal ring B55/80x10 Domsel NBR+A2	1
52	6074592	shaft sealing H35/2 VP.	1
		alternativ / alternative / alternative	
52	6075005	shaft sealing H35/2 1.4462 VP.	1
22	6080478	o-ring ID.65,0x3,0 Viton molyk.70 (2pc)	1
53	6017267	base plate D.392 51.17882 Al/C0	1
54		screw M8x16 DIN933 A4-70	6
55		washer A8,4 DIN125 1.4401 (20pc)	1
56	6004875	strainer 175x380x2 51.17883 1.4301	1
57	6010755	spacer M20x65 DIN933 54.17884 A4	6
58	6002685	rubber buffer Tiegler B/GM40 NB	6
59		Dubo-washer M12 NR.207 PA	6
60	6010756	discharge piece G6 52.17885 GGG/C0	1
61		screw M8x40 DIN939 A4	4
62		washer 8,4 DIN7349 A4 (10pc)	1
63		nut M8 DIN934 A4	8
64		O-RING ID.184X8N DIN3771 NBR70	1
65	6017259	handle 52.17887 1.4581	1
66	6003986	handle 52.17333 St-Gummi	1
67		screw M12x30 DIN933 A4-70	2
68		washer A13 DIN125 A4 (20pc)	1
69	6003030	shackle 16mm 1.4401	1
		Laufrad / Impeller / Roue 50Hz	
70	6017861	impeller-N/MN D.175 52.17969 Abrasit	1
		Laufrad / Impeller / Roue 60Hz	

CONTRACTOR'S PUMP KS220MN (Bm0)

Item	Article no.	Description	Quantity
70	6021655	impeller-N/MN D.162 52.17969 Abrasit	1
71	6011711	washer D.35/11x16 55.1865 1.4021	1
		alternativ / alternative / alternative	
71	6011710	washer D.35/11x16 55.1865 1.4462	1
72	6003623	screw M10x30 DIN933 10.9 Geomet	1
73	2043863	SCREW LOCKING NORD-LOCK 16/10,7 A4	1
74	6003012	plug CEE63A/400V/5P-6H/IP67	1

cablE trumpet 60T KIT

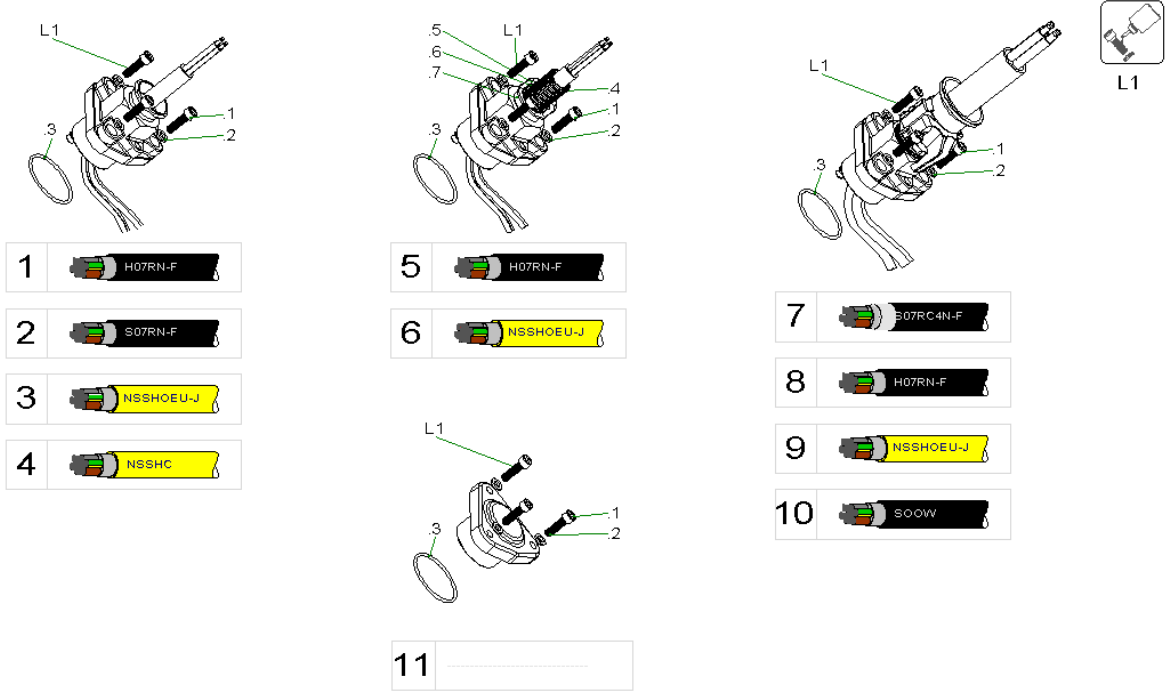

cable trumpet 60T KIT

Item	Article no.	Description	Quantity
L1	6080531	Loctite 243 5g flask VP:	1
.1	6078159	screw M8x30 DIN912 A4-70 (10pc)	3
.2	6078161	shim ring 8x14x1,0 DIN988 A2 (10pc)	3
.3	6007747	o-ring ID.60,0x3,0 NBR70	1
.4	6062009	protecting cover 42,5/35,5 PA6	
.5	6017168	screw cap D.29 54.13974 1.4401	1
.6	6078163	o-ring ID.20,0x3,0 Viton 75 (3pc)	1
.7	6017170	screwed hose connection Pg29 55.13614 1.	1
1	6001513	cable trumpet 60T 20m H07 4x1,5 KIT	1
1	6001535	cable trumpet 60T 10m H07 10x1,5 KIT	1
2	6035224	cable trumpet 60T 20m S07RN-F 4G6(4x1)	1
2	6045369	cable trumpet 60T 50m S07RN-F 4G6(4x1)	1
3	6001346	cable trumpet 60T 5m NSS 4x1,5 KIT	1
3	6001347	cable trumpet 60T 10m NSS 4x1,5 KIT	1
3	6001348	cable trumpet 60T 15m NSS 4x1,5 KIT	1
3	6001349	cable trumpet 60T 20m NSS 4x1,5 KIT	1
3	6001354	cable trumpet 60T 5m NSS 4x2,5 KIT	1
3	6001355	cable trumpet 60T 10m NSS 4x2,5 KIT	1
3	6001356	cable trumpet 60T 15m NSS 4x2,5 KIT	1
3	6001357	cable trumpet 60T 20m NSS 4x2,5 KIT	1
3	6001358	cable trumpet 60T 5m NSS 4x4 KIT	1
3	6001359	cable trumpet 60T 10m NSS 4x4 KIT	1
3	6001360	Cable Trumpet 60T 15m NSS 4x4 KIT	1
3	6001361	cable trumpet 60T 20m NSS 4x4 KIT	1
3	6042246	cable trumpet 60T 25m NSS 4x4 KIT	1
3	6001482	cable trumpet 60T 5m NSS 4x6 KIT	1
3	6001483	Leitungsdurchf. 60T 10m NSS 4x6 SET	1
3	6001484	cable trumpet 60T 15M NSS 4x6 KIT	1
3	6001485	cable trumpet 60T 20m NSS 4x6 KIT	1
3	6001486	cable trumpet 60T 5m NSS 4x10 KIT	1
3	6001487	cable trumpet 60T 10M NSS 4x10 KIT	1
3	6001488	cable trumpet 60T 15m NSS 4x10 KIT	1
3	6001489	cable trumpet 60T 20m NSS 4x10 KIT	1
3	6001364	cable trumpet 60T 5m NSS 7x1,5 KIT	1

cable trumpet 60T KIT

Item	Article no.	Description	Quantity
3	6001365	cable trumpet 60T 10m NSS 7x1,5 KIT	1
3	6001366	cable trumpet 60T 15m NSS 7x1,5 KIT	1
3	6001367	cable trumpet 60T 20m NSS 7x1,5 KIT	1
3	6001335	cable trumpet 60T 5m NSS 7x2,5 KIT	1
3	6001334	cable trumpet 60T 10m NSS 7x2,5 KIT	1
3	6001336	cable trumpet 60T 15m NSS 7x2,5 KIT	1
3	6001337	cable trumpet 60T 20m NSS 7x2,5 KIT	1
3	6020377	cable trumpet 60T 25m NSS 7x2,5 KIT	1
3	6038669	cable trumpet 60T 50m NSS 7x2,5 KIT	1
3	6001368	cable trumpet 60T 5m NSS 10x1,5 KIT	1
3	6001369	cable trumpet 60T 10m NSS 10x1,5 KIT	1
3	6001480	cable trumpet 60T 15m NSS 10x1,5 KIT	1
3	6001481	cable trumpet 60T 20m NSS 10x1,5 KIT	1
4	6070013	cable trumpet 60T 15m NSSHC 3x16+3x2,5	1
6	6067482	cable trumpet 60T 10m NSS 4x10 C KIT	1
6	6039693	cable trumpet 60T 10m NSS 7x2,5 C KIT	1
7	6081596	cable trumpet 60T 10m S07RC4N-F 4G4	1
7	6085233	cable trumpet 60T 15m S07RC4N-F 4G4	1
7	6026674	cable trumpet 60T 20m S07RC4N-F 4G4	1
7	6066387	cable trumpet 60T 10m S07RC4N8-F 4G16	1
7	6061984	cable trumpet 60T 15m S07RC4N8-F 4G16	1
7	6063564	cable trumpet 60T 40m S07RC4N8-F 4G16	1
7	6085234	cable trumpet 60T 15m S07RC4N8-F 4G25	1
9	6001490	cable trumpet 60T 5m NSS 4x16 KIT	1
9	6001491	cable trumpet 60T 10m NSS 4x16 KIT	1
9	6001492	cable trumpet 60T 15m NSS 4x16 KIT	1
9	6001493	cable trumpet 60T 20m NSS 4x16 KIT	1
9	6021510	cable trumpet 60T 30m NSS 4x16 KIT	1
9	6042287	cable trumpet 60T 60m NSS 4x16 KIT	1
9	6001494	cable trumpet 60T 5m NSS 4x25 KIT	1
9	6001495	cable trumpet 60T 10m NSS 4x25 KIT	1
9	6001496	cable trumpet 60T 15m NSS 4x25 KIT	1
9	6001497	cable trumpet 60T 20m NSS 4x25 KIT	1
9	6034270	cable trumpet 60T 30m NSS 4x25 KIT	1

cable trumpet 60T KIT

Item	Article no.	Description	Quantity
9	6070758	cable trumpet 60T 40m NSS 4x25 KIT	1
10	6065154	cable trumpet 60T 10m 4* AWG4	1
10	6065155	cable trumpet 60T 20m 4* AWG4	1
11	6044718	plug 60T KIT	1

cablE trumpet 42T KIT

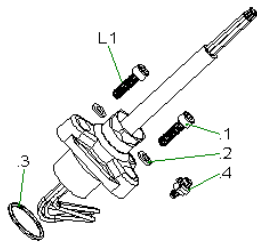

- 1 H07RN-F
- 2 S07RN-F
- 3 NSSHOEU-J
- 4 S07RC4N-F
- 5 SOOW
- 6 NSSHC0U-J

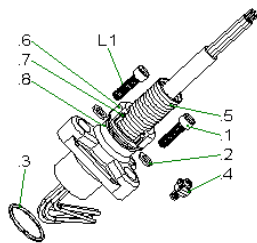

- 7 S07RC4N-F
- 8 H07RN-F
- 9 NSSHOEU-J
- 10 H07RN-F
- 11 NSSHOEU-J

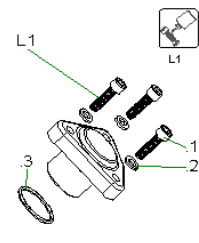

- 12 -----
- 13 NSSHC0U-J
- 14 NSSHOEU-J
- 15 S07RC4N-F
- 16 SOOW

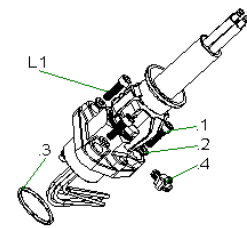

cable trumpet 42T KIT

Item	Article no.	Description	Quantity
L1	6080531	Loctite 243 5g flask VP:	1
.1	6078159	screw M8x30 DIN912 A4-70 (10pc)	3
.2	6078161	shim ring 8x14x1,0 DIN988 A2 (10pc)	3
.3	6078162	o-ring ID.40,0x3,0 Viton (3pc)	1
.4	6067407	Barlian bow terminal M5 A2	1
.5	6007918	protecting hose 28,5/22,8 PA6	
.6	6017168	screw cap D.29 54.13974 1.4401	1
.7	6078163	o-ring ID.20,0x3,0 Viton 75 (3pc)	1
1	6000688	cable trumpet 42T 5m H07 7G1,5 KIT	1
1	6000689	CABLE TRUMPET 42T 10M H07 7G1,5 KIT	1
1	6000690	cable trumpet 42T 15m H07 7G1,5 KIT	1
1	6000691	cable trumpet 42T 20m H07 7G1,5 SET	1
1	6024687	cable trumpet 42T 25m H07 7G1,5 KIT	1
1	6032527	cable trumpet 42T 30m H07 7G1,5 KIT	1
1	6066420	cable trumpet 42T 35m H07 7G1,5 KIT	1
1	6000692	cable trumpet 42T 5m H07 10G1,5 KIT	1
1	6001115	cable trumpet 42T 10m H07 10G1,5 KIT	1
1	6000693	cable trumpet 42T 15m H07 10G1,5 KIT	1
1	6000694	cable trumpet 42T 20m H07 10G1,5 KIT	1
1	6046176	cable trumpet 42T 25m H07 10G1,5 KIT	1
2	6038293	cable trumpet 42T 10m S07RN-F 4G6(4x1)	1
3	6000699	cable trumpet 42T 5m NSS 2x1,5 KIT	1
3	6000700	cable trumpet 42T 10m NSS 2x1,5 KIT	1
3	6000701	cable trumpet 42T 15m NSS 2x1,5 KIT	1
3	6000702	cable trumpet 42T 20m NSS 2x1,5 KIT	1
3	6075910	cable trumpet 42T 25m NSS 2x1,5 KIT	1
3	6061578	cable trumpet 42T 30m NSS 2x1,5 KIT	1
3	6065996	cable trumpet 42T 45m NSS 2x1,5 KIT	1
3	6000703	cable trumpet 42T 5m NSS 4x1,5 KIT	1
3	6000704	cable trumpet 42T 10m NSS 4x1,5 KIT	1
3	6000705	Cable Trumpet 42T 15m NSS 4x1,5 KIT	1
3	6000706	cable trumpet 42T 20m NSS 4x1,5 KIT	1
3	6020376	cable trumpet 42T 25m NSS 4x1,5 KIT	1
3	6019867	cable trumpet 42T 30m NSS 4x1,5 KIT	1

cable trumpet 42T KIT

Item	Article no.	Description	Quantity
3	6036907	cable trumpet 42T 35m NSS 4x1,5 KIT	1
3	6038670	cable trumpet 42T 50m NSS 4x1,5 KIT	1
3	6040496	cable trumpet 42T 60m NSS 4x1,5 KIT	1
3	6000707	cable trumpet 42T 5m NSS 4x2,5 KIT	1
3	6000708	cable trumpet 42T 10m NSS 4x2,5 KIT	1
3	6000709	cable trumpet 42T 15m NSS 4x2,5 KIT	1
3	6001426	cable trumpet 42T 20m NSS 4x2,5 KIT	1
3	6066888	cable trumpet 42T 25m NSS 4x2,5 KIT	1
3	6001427	cable trumpet 42T 5m NSS 4x4 KIT	1
3	6001428	cable trumpet 42T 10m NSS 4x4 KIT	1
3	6001429	cable trumpet 42T 15m NSS 4x4 KIT	1
3	6001430	cable trumpet 42T 20m NSS 4x4 KIT	1
3	6075909	cable trumpet 42T 25m NSS 4x4 KIT	1
3	6067861	cable trumpet 42T 30m NSS 4x4 KIT	1
3	6072786	cable trumpet 42T 10m NSS 4x6 KIT	1
3	6066425	cable trumpet 42T 15m NSS 4x6 KIT	1
3	6068990	cable trumpet 42T 20m NSS 4x6 KIT	1
3	6065995	cable trumpet 42T 30m NSS 4x6 KIT	1
3	6065994	cable trumpet 42T 45m NSS 4x6 KIT	1
3	6040497	cable trumpet 42T 60m NSS 4x6 KIT	1
3	6044835	cable trumpet 42T 10m NSS 4x10 KIT	1
3	6067481	cable trumpet 42T 15m NSS 4x10 KIT	1
3	6070122	cable trumpet 42T 30m NSS 4x10 KIT	1
3	6001431	cable trumpet 42T 5m NSS 7x1,5 KIT	1
3	6001432	cable trumpet 42T 10m NSS 7x1,5 KIT	1
3	6001433	cable trumpet 42T 15m NSS 7x1,5 KIT	1
3	6001434	cable trumpet 42T 20m NSS 7x1,5 KIT	1
3	6040684	cable trumpet 42T 25m NSS 7x1,5 KIT	1
3	6074636	cable trumpet 42T 40m NSS 7x1,5 KIT	1
3	6001435	cable trumpet 42T 5m NSS 7x2,5 KIT	1
3	6001436	cable trumpet 42T 10M NSS 7x2,5 KIT	1
3	6001437	cable trumpet 42T 15m NSS 7x2,5 KIT	1
3	6001438	cable trumpet 42T 20m NSS 7x2,5 KIT	1
3	6036937	cable trumpet 42T 25m NSS 7x2,5 KIT	1

cable trumpet 42T KIT

Item	Article no.	Description	Quantity
3	6036906	cable trumpet 42T 35m NSS 7x2,5 KIT	1
3	6086145	cable trumpet 42T 10m NSS 10x1,5 SET	1
3	6068144	cable trumpet 42T 15m NSS 10x1,5 KIT	1
3	6078651	cable trumpet 42T 20m NSS 10x1,5 SET	1
3	6078807	cable trumpet 42T 25m NSS 10x1,5 SET	1
4	6046317	cable trumpet 42T 10m S07RC4N-F 4x1,5	1
4	6063563	cable trumpet 42T 40m S07RC4N-F 4x1,5	1
4	6066388	cable trumpet 42T 10m S07RC4N-F 7x1,5KIT	1
4	6061983	cable trumpet 42T 15m S07RC4N-F 4x1,5KIT	1
4	6046316	cable trumpet 42T 20m S07RC4N-F 4x4	1
5	6065152	cable trumpet 42T 10m 2* AWG14	1
5	6065153	cable trumpet 42T 20m 2* AWG14	1
5	6066488	cable trumpet 42T 20m 4* AWG14	1
5	6065151	cable trumpet 42T 10m 7* AWG14	1
5	6066489	cable trumpet 42T 20m 7* AWG14	1
5	6065150	cable trumpet 42T 10m 4* AWG10	1
6	2132620	on request	1

7	6067898	cable trumpet 42T 10m S07RC4N-F 12G1,5 C	1
8	6019360	cable trumpet 42T 5m H07 7G1,5 C KIT	1
8	6019362	cable trumpet 42T 15m H07 7G1,5 C KIT	1
9	6037455	cable trumpet 42T 10m NSS 4x1,5 C KIT	1
9	6019374	cable trumpet 42T 15m NSS 4x2,5 C KIT	1
9	6019381	cable trumpet 42T 10m NSS 7x1,5 C KIT	1
9	6019382	cable trumpet 42T 15m NSS 7x1,5 C KIT	1
9	6037454	cable trumpet 42T 10m NSS 7x2,5 C KIT	1
9	6019387	cable trumpet 42T 20m NSS 7x2,5 C KIT	1
9	6079792	cable trumpet 42T 30m NSS 7x2,5 C KIT	1
10	6019849	cable trumpet 42T RF 10m H07 7G1,5 KIT	1
10	6035148	cable trumpet 42T RF 15m H07 7G1,5 KIT	1
10	6038689	cable trumpet 42T RF 20m H07 7G1,5 KIT	1
11	6032612	cable trumpet 42T RF 10m NSS 7x1,5 KIT	1
11	6034277	cable trumpet 42T RF 30m NSS 7x1,5 KIT	1

cable trumpet 42T KIT

Item	Article no.	Description	Quantity
12	6044717	plug 42T KIT	1
13	6070010	cable trumpet 42T 15m NSSHC 3x16+3x2,5	1
14	6044834	cable trumpet 42T 10m NSS 4x16 KIT	1
14	6067480	cable trumpet 42T 15m NSS 4x16 KIT	1
14	6066168	cable trumpet 42T 20m NSS 4x16 KIT	1
14	6069678	cable trumpet 42T 25m NSS 4x16 KIT	1
14	6081974	cable trumpet 42T 40m NSS 4x16 KIT	1
15	6063562	cable trumpet 42T 40m S07RC4N-F 4x16	1
16	6067560	cable trumpet 42T 20m 4* AWG6	1

CONTRACTOR'S PUMP KS220MN (Bm1)

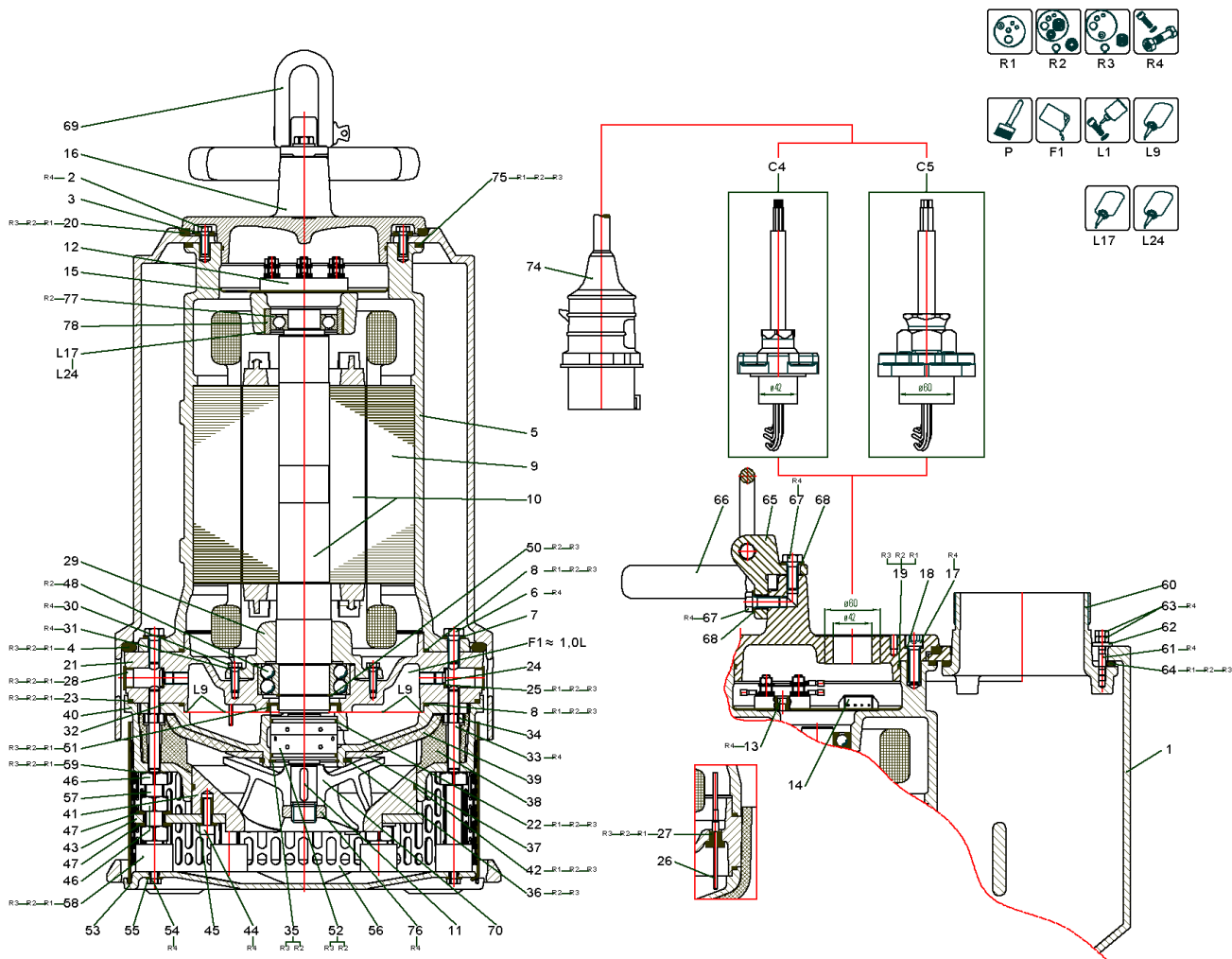

CONTRACTOR'S PUMP KS220MN (Bm1)

Item	Article no.	Description	Quantity
R1	6016273	Rep.Kit 1 KS220 Vit	1
R2	6016288	Rep.Kit 2 KS220 Vit	1
R3	6016321	Rep.Kit 3 KS220 Vit	1
R4	6016127	Screws KS220 KIT	1
P	6042254	PAINT SPRAY Pantone334	1
P	6042255	colour 2K-paint IV80 pantone334C 250ml	1
P	6023614	Ceram C0 black 100 ml KIT	1
P	6020579	Ceram C0 black 250 ml KIT	1
P	6023485	Ceram C0 Black 500ml Kit	1
P	6019157	Ceram C0 black 1000 ml KIT	1
F1	6025460	medical white oil 1L KIT	1
F1	6025461	medical white oil 5L KIT	1
L1	6080531	Loctite 243 5g flask VP:	1
L1	2096167	Loctite 243 50ml VP.	1
L9	6080535	Loctite 5203 300ml VP.	1
L17		Loctite 7649 500ml	1
L24	6063947	Loctite 3504 50ml	1

C5		cable trumpet 60T KIT	1
C4		cable trumpet 42T KIT	2

1	6017268	pump shroud SG6 50.17861 Al/C0 alternativ / alternative / alternative	1
1	6032053	pump shroud SG6 50.17861 3.1371.61/C0	1
2		screw M8x25 DIN933 A4-70 (10pc)	1
3		washer 8,4 DIN7349 A4 (10pc)	1
4		o-ring ID.360,0x15,0 NBR55	1
5		motor casing 51.17863/1 Al	1
Note: auf Anfrage / on request / sur demande			
78		bush D.85/71x27 6050391 1.4462	1
Note: auf Anfrage / on request / sur demande			
75	6063517	o-ring ID.242,0x6,0 Viton	1
6		screw M12x30 DIN933 A4-70	6
7		washer A13 DIN125 A4 (20pc)	1

CONTRACTOR'S PUMP KS220MN (Bm1)

Item	Article no.	Description	Quantity
8		o-ring ID.255,0x4,0 Viton	1
9	6081415	Stator T24-2/21 400/690 50 PTC110° VP.	1
10	6045397	rotor D.133,5x557 2/21 4021/4462 g	1
		alternativ / alternative / alternative	
10	6045395	rotor D.133,5x557 2/21 4021/4462 g	1
76	6038971	nut M27x2,0 DIN439 A2	1
11	6076643	key A 8x5x36 DIN6885 A4 VP.	1
12	6070362	terminal board 6pol. konf.	1
13		screw M6x16 DIN912 A4 (10pc)	1
14	6002712	connectors pin strip 4-polig	1
15	6010193	cover disc D.182 54.18083 MVL-UE	1
		1x Ø 60mm gebohrt / drilled / percè	
16	6010758	motor cover D.60 51.17865 GG/C0	1
		2xØ 42mm gebohrt / drilled / percè	
16	6010757	motor cover D.42 51.17865 GG/C0	1
17		screw M12x40 DIN912 A4-70 (10pc)	1
18		lock washer 12 DIN7980 A4	4
19		o-ring ID.170,0x3,0 NBR70	1
20		o-ring ID.250,0x8,0 NBR70	1
21	6010652	bearing housing 51.17867 GG/C0	1
8		o-ring ID.255,0x4,0 Viton	1
23		O-Ring ID.360,0x4,0 Viton 75 VP.	1
24	6002435	screw plug G1/4 A DIN908 A4	2
25	6007522	seal ring A14/18x1,5 DIN7603 PA	2
26	6017145	electrode rod D.4x77 54.13422 A2	2
27	6078171	sealing plug 13421 NBR 80 VP.	2
28	6007419	plug GPN300 F19 Plastik	2
29	6010648	bearing cover D.110H7 52.17868 Al	1
30		screw M8x25 DIN933 A4-70 (10pc)	1
31		washer A8,4 DIN125 1.4401 (20pc)	1
32	6010622	sealing flange D.355 51.17870 Al/C0	1
33		screw M12x85 DIN939 A2-70	6
34		nut M12 DIN934 A4-80 (10pcs)	1
35	6002185	circlips 72x2,5 DIN472 A2	1

CONTRACTOR'S PUMP KS220MN (Bm1)

Item	Article no.	Description	Quantity
36	6002053	circlips 90x3 DIN471 A2	1
37	6016948	washer D.90/170x7 54.18086 1.4301	1
38	6004316	guide casing 17871 PUR raw	1
39	6004703	wear plate 17873 PUR raw	1
40	6010927	pump housing A 51.17874 Al/C0	1
41	6010654	suction port D.244 52.17877 PA12G	1
42		o-ring ID.230,0x4,0 NBR70	1
43	6016949	supporting plate 52.18084 1.4301	1
44		screw M10x30 ISO4762 A4-70	3
45		Washer A10,5 DIN125 A4 (20pcs)	1
46		nut M20 DIN934 A4-80 (10pc)	1
47		WASHER A21 DIN125 A4 (10pc)	1
48	6081300	ball bearing 5211 VP.	1
77	6081345	ball bearing 6207 w.2 Dichts. VP.	1
50	6081303	Circlip 55x2 DIN471 FSt VP.	1
51	6007473	shaft seal ring B55/80x10 Domsel NBR+A2	1
52	6074592	shaft sealing H35/2 VP.	1
		alternativ / alternative / alternative	
52	6075005	shaft sealing H35/2 1.4462 VP.	1
22	6080478	o-ring ID.65,0x3,0 Viton molyk.70 (2pc)	1
53	6017267	base plate D.392 51.17882 Al/C0	1
54		screw M8x16 DIN933 A4-70	6
55		washer A8,4 DIN125 1.4401 (20pc)	1
56	6004875	strainer 175x380x2 51.17883 1.4301	1
57	6010755	spacer M20x65 DIN933 54.17884 A4	6
58	6002685	rubber buffer Tiegler B/GM40 NB	6
59		Dubo-washer M12 NR.207 PA	6
60	6010756	discharge piece G6 52.17885 GGG/C0	1
61		screw M8x40 DIN939 A4	4
62		washer 8,4 DIN7349 A4 (10pc)	1
63		nut M8 DIN934 A4	8
64		O-RING ID.184X8N DIN3771 NBR70	1
65	6017259	handle 52.17887 1.4581	1
66	6003986	handle 52.17333 St-Gummi	1

CONTRACTOR'S PUMP KS220MN (Bm1)

Item	Article no.	Description	Quantity
67		screw M12x30 DIN933 A4-70	2
68		washer A13 DIN125 A4 (20pc)	1
69	6003030	shackle 16mm 1.4401	1
		Laufrad / Impeller / Roue 50Hz	
70	6017861	impeller-N/MN D.175 52.17969 Abrasit	1
		Laufrad / Impeller / Roue 60Hz	
70	6021655	impeller-N/MN D.162 52.17969 Abrasit	1
74	6003012	plug CEE63A/400V/5P-6H/IP67	1

cablE trumpet 60T KIT

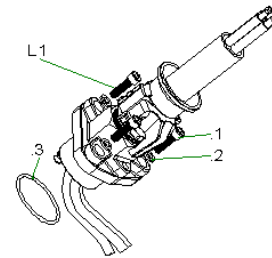
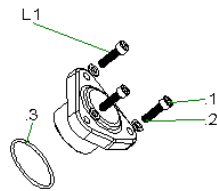
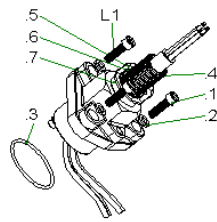
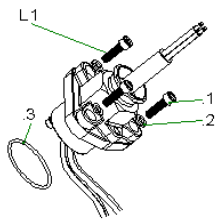

L1



cable trumpet 60T KIT

Item	Article no.	Description	Quantity
L1	6080531	Loctite 243 5g flask VP:	1
.1	6078159	screw M8x30 DIN912 A4-70 (10pc)	3
.2	6078161	shim ring 8x14x1,0 DIN988 A2 (10pc)	3
.3	6007747	o-ring ID.60,0x3,0 NBR70	1
.4	6062009	protecting cover 42,5/35,5 PA6	
.5	6017168	screw cap D.29 54.13974 1.4401	1
.6	6078163	o-ring ID.20,0x3,0 Viton 75 (3pc)	1
.7	6017170	screwed hose connection Pg29 55.13614 1.	1
1	6001513	cable trumpet 60T 20m H07 4x1,5 KIT	1
1	6001535	cable trumpet 60T 10m H07 10x1,5 KIT	1
2	6035224	cable trumpet 60T 20m S07RN-F 4G6(4x1)	1
2	6045369	cable trumpet 60T 50m S07RN-F 4G6(4x1)	1
3	6001346	cable trumpet 60T 5m NSS 4x1,5 KIT	1
3	6001347	cable trumpet 60T 10m NSS 4x1,5 KIT	1
3	6001348	cable trumpet 60T 15m NSS 4x1,5 KIT	1
3	6001349	cable trumpet 60T 20m NSS 4x1,5 KIT	1
3	6001354	cable trumpet 60T 5m NSS 4x2,5 KIT	1
3	6001355	cable trumpet 60T 10m NSS 4x2,5 KIT	1
3	6001356	cable trumpet 60T 15m NSS 4x2,5 KIT	1
3	6001357	cable trumpet 60T 20m NSS 4x2,5 KIT	1
3	6001358	cable trumpet 60T 5m NSS 4x4 KIT	1
3	6001359	cable trumpet 60T 10m NSS 4x4 KIT	1
3	6001360	Cable Trumpet 60T 15m NSS 4x4 KIT	1
3	6001361	cable trumpet 60T 20m NSS 4x4 KIT	1
3	6042246	cable trumpet 60T 25m NSS 4x4 KIT	1
3	6001482	cable trumpet 60T 5m NSS 4x6 KIT	1
3	6001483	Leitungsdurchf. 60T 10m NSS 4x6 SET	1
3	6001484	cable trumpet 60T 15M NSS 4x6 KIT	1
3	6001485	cable trumpet 60T 20m NSS 4x6 KIT	1
3	6001486	cable trumpet 60T 5m NSS 4x10 KIT	1
3	6001487	cable trumpet 60T 10M NSS 4x10 KIT	1
3	6001488	cable trumpet 60T 15m NSS 4x10 KIT	1
3	6001489	cable trumpet 60T 20m NSS 4x10 KIT	1
3	6001364	cable trumpet 60T 5m NSS 7x1,5 KIT	1

cable trumpet 60T KIT

Item	Article no.	Description	Quantity
3	6001365	cable trumpet 60T 10m NSS 7x1,5 KIT	1
3	6001366	cable trumpet 60T 15m NSS 7x1,5 KIT	1
3	6001367	cable trumpet 60T 20m NSS 7x1,5 KIT	1
3	6001335	cable trumpet 60T 5m NSS 7x2,5 KIT	1
3	6001334	cable trumpet 60T 10m NSS 7x2,5 KIT	1
3	6001336	cable trumpet 60T 15m NSS 7x2,5 KIT	1
3	6001337	cable trumpet 60T 20m NSS 7x2,5 KIT	1
3	6020377	cable trumpet 60T 25m NSS 7x2,5 KIT	1
3	6038669	cable trumpet 60T 50m NSS 7x2,5 KIT	1
3	6001368	cable trumpet 60T 5m NSS 10x1,5 KIT	1
3	6001369	cable trumpet 60T 10m NSS 10x1,5 KIT	1
3	6001480	cable trumpet 60T 15m NSS 10x1,5 KIT	1
3	6001481	cable trumpet 60T 20m NSS 10x1,5 KIT	1
4	6070013	cable trumpet 60T 15m NSSHC 3x16+3x2,5	1
6	6067482	cable trumpet 60T 10m NSS 4x10 C KIT	1
6	6039693	cable trumpet 60T 10m NSS 7x2,5 C KIT	1
7	6081596	cable trumpet 60T 10m S07RC4N-F 4G4	1
7	6085233	cable trumpet 60T 15m S07RC4N-F 4G4	1
7	6026674	cable trumpet 60T 20m S07RC4N-F 4G4	1
7	6066387	cable trumpet 60T 10m S07RC4N8-F 4G16	1
7	6061984	cable trumpet 60T 15m S07RC4N8-F 4G16	1
7	6063564	cable trumpet 60T 40m S07RC4N8-F 4G16	1
7	6085234	cable trumpet 60T 15m S07RC4N8-F 4G25	1
9	6001490	cable trumpet 60T 5m NSS 4x16 KIT	1
9	6001491	cable trumpet 60T 10m NSS 4x16 KIT	1
9	6001492	cable trumpet 60T 15m NSS 4x16 KIT	1
9	6001493	cable trumpet 60T 20m NSS 4x16 KIT	1
9	6021510	cable trumpet 60T 30m NSS 4x16 KIT	1
9	6042287	cable trumpet 60T 60m NSS 4x16 KIT	1
9	6001494	cable trumpet 60T 5m NSS 4x25 KIT	1
9	6001495	cable trumpet 60T 10m NSS 4x25 KIT	1
9	6001496	cable trumpet 60T 15m NSS 4x25 KIT	1
9	6001497	cable trumpet 60T 20m NSS 4x25 KIT	1
9	6034270	cable trumpet 60T 30m NSS 4x25 KIT	1

cable trumpet 60T KIT

Item	Article no.	Description	Quantity
9	6070758	cable trumpet 60T 40m NSS 4x25 KIT	1
10	6065154	cable trumpet 60T 10m 4* AWG4	1
10	6065155	cable trumpet 60T 20m 4* AWG4	1
11	6044718	plug 60T KIT	1

cablE trumpet 42T KIT

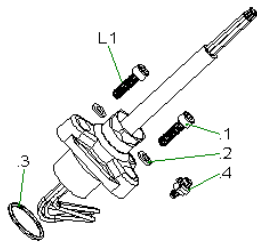

- 1 H07RN-F
- 2 S07RN-F
- 3 NSSHOEU-J
- 4 S07RC4N-F
- 5 SOOW
- 6 NSSHC0U-J

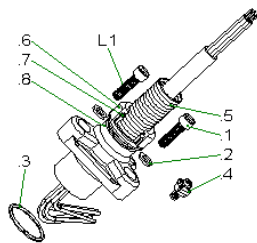

- 7 S07RC4N-F
- 8 H07RN-F
- 9 NSSHOEU-J
- 10 H07RN-F
- 11 NSSHOEU-J

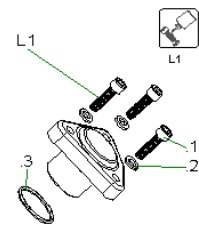
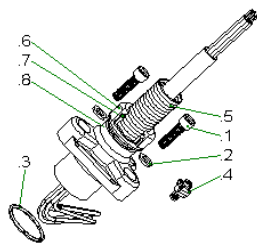

- 12 -----

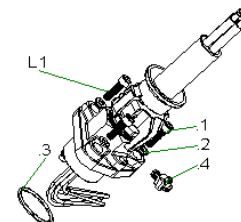

- 13 NSSHC0U-J
- 14 NSSHOEU-J
- 15 S07RC4N-F
- 16 SOOW

cable trumpet 42T KIT

Item	Article no.	Description	Quantity
L1	6080531	Loctite 243 5g flask VP:	1
.1	6078159	screw M8x30 DIN912 A4-70 (10pc)	3
.2	6078161	shim ring 8x14x1,0 DIN988 A2 (10pc)	3
.3	6078162	o-ring ID.40,0x3,0 Viton (3pc)	1
.4	6067407	Barlian bow terminal M5 A2	1
.5	6007918	protecting hose 28,5/22,8 PA6	
.6	6017168	screw cap D.29 54.13974 1.4401	1
.7	6078163	o-ring ID.20,0x3,0 Viton 75 (3pc)	1
1	6000688	cable trumpet 42T 5m H07 7G1,5 KIT	1
1	6000689	CABLE TRUMPET 42T 10M H07 7G1,5 KIT	1
1	6000690	cable trumpet 42T 15m H07 7G1,5 KIT	1
1	6000691	cable trumpet 42T 20m H07 7G1,5 SET	1
1	6024687	cable trumpet 42T 25m H07 7G1,5 KIT	1
1	6032527	cable trumpet 42T 30m H07 7G1,5 KIT	1
1	6066420	cable trumpet 42T 35m H07 7G1,5 KIT	1
1	6000692	cable trumpet 42T 5m H07 10G1,5 KIT	1
1	6001115	cable trumpet 42T 10m H07 10G1,5 KIT	1
1	6000693	cable trumpet 42T 15m H07 10G1,5 KIT	1
1	6000694	cable trumpet 42T 20m H07 10G1,5 KIT	1
1	6046176	cable trumpet 42T 25m H07 10G1,5 KIT	1
2	6038293	cable trumpet 42T 10m S07RN-F 4G6(4x1)	1
3	6000699	cable trumpet 42T 5m NSS 2x1,5 KIT	1
3	6000700	cable trumpet 42T 10m NSS 2x1,5 KIT	1
3	6000701	cable trumpet 42T 15m NSS 2x1,5 KIT	1
3	6000702	cable trumpet 42T 20m NSS 2x1,5 KIT	1
3	6075910	cable trumpet 42T 25m NSS 2x1,5 KIT	1
3	6061578	cable trumpet 42T 30m NSS 2x1,5 KIT	1
3	6065996	cable trumpet 42T 45m NSS 2x1,5 KIT	1
3	6000703	cable trumpet 42T 5m NSS 4x1,5 KIT	1
3	6000704	cable trumpet 42T 10m NSS 4x1,5 KIT	1
3	6000705	Cable Trumpet 42T 15m NSS 4x1,5 KIT	1
3	6000706	cable trumpet 42T 20m NSS 4x1,5 KIT	1
3	6020376	cable trumpet 42T 25m NSS 4x1,5 KIT	1
3	6019867	cable trumpet 42T 30m NSS 4x1,5 KIT	1

cable trumpet 42T KIT

Item	Article no.	Description	Quantity
3	6036907	cable trumpet 42T 35m NSS 4x1,5 KIT	1
3	6038670	cable trumpet 42T 50m NSS 4x1,5 KIT	1
3	6040496	cable trumpet 42T 60m NSS 4x1,5 KIT	1
3	6000707	cable trumpet 42T 5m NSS 4x2,5 KIT	1
3	6000708	cable trumpet 42T 10m NSS 4x2,5 KIT	1
3	6000709	cable trumpet 42T 15m NSS 4x2,5 KIT	1
3	6001426	cable trumpet 42T 20m NSS 4x2,5 KIT	1
3	6066888	cable trumpet 42T 25m NSS 4x2,5 KIT	1
3	6001427	cable trumpet 42T 5m NSS 4x4 KIT	1
3	6001428	cable trumpet 42T 10m NSS 4x4 KIT	1
3	6001429	cable trumpet 42T 15m NSS 4x4 KIT	1
3	6001430	cable trumpet 42T 20m NSS 4x4 KIT	1
3	6075909	cable trumpet 42T 25m NSS 4x4 KIT	1
3	6067861	cable trumpet 42T 30m NSS 4x4 KIT	1
3	6072786	cable trumpet 42T 10m NSS 4x6 KIT	1
3	6066425	cable trumpet 42T 15m NSS 4x6 KIT	1
3	6068990	cable trumpet 42T 20m NSS 4x6 KIT	1
3	6065995	cable trumpet 42T 30m NSS 4x6 KIT	1
3	6065994	cable trumpet 42T 45m NSS 4x6 KIT	1
3	6040497	cable trumpet 42T 60m NSS 4x6 KIT	1
3	6044835	cable trumpet 42T 10m NSS 4x10 KIT	1
3	6067481	cable trumpet 42T 15m NSS 4x10 KIT	1
3	6070122	cable trumpet 42T 30m NSS 4x10 KIT	1
3	6001431	cable trumpet 42T 5m NSS 7x1,5 KIT	1
3	6001432	cable trumpet 42T 10m NSS 7x1,5 KIT	1
3	6001433	cable trumpet 42T 15m NSS 7x1,5 KIT	1
3	6001434	cable trumpet 42T 20m NSS 7x1,5 KIT	1
3	6040684	cable trumpet 42T 25m NSS 7x1,5 KIT	1
3	6074636	cable trumpet 42T 40m NSS 7x1,5 KIT	1
3	6001435	cable trumpet 42T 5m NSS 7x2,5 KIT	1
3	6001436	cable trumpet 42T 10M NSS 7x2,5 KIT	1
3	6001437	cable trumpet 42T 15m NSS 7x2,5 KIT	1
3	6001438	cable trumpet 42T 20m NSS 7x2,5 KIT	1
3	6036937	cable trumpet 42T 25m NSS 7x2,5 KIT	1

cable trumpet 42T KIT

Item	Article no.	Description	Quantity
3	6036906	cable trumpet 42T 35m NSS 7x2,5 KIT	1
3	6086145	cable trumpet 42T 10m NSS 10x1,5 SET	1
3	6068144	cable trumpet 42T 15m NSS 10x1,5 KIT	1
3	6078651	cable trumpet 42T 20m NSS 10x1,5 SET	1
3	6078807	cable trumpet 42T 25m NSS 10x1,5 SET	1
4	6046317	cable trumpet 42T 10m S07RC4N-F 4x1,5	1
4	6063563	cable trumpet 42T 40m S07RC4N-F 4x1,5	1
4	6066388	cable trumpet 42T 10m S07RC4N-F 7x1,5KIT	1
4	6061983	cable trumpet 42T 15m S07RC4N-F 4x1,5KIT	1
4	6046316	cable trumpet 42T 20m S07RC4N-F 4x4	1
5	6065152	cable trumpet 42T 10m 2* AWG14	1
5	6065153	cable trumpet 42T 20m 2* AWG14	1
5	6066488	cable trumpet 42T 20m 4* AWG14	1
5	6065151	cable trumpet 42T 10m 7* AWG14	1
5	6066489	cable trumpet 42T 20m 7* AWG14	1
5	6065150	cable trumpet 42T 10m 4* AWG10	1
6	2132620	on request	1

7	6067898	cable trumpet 42T 10m S07RC4N-F 12G1,5 C	1
8	6019360	cable trumpet 42T 5m H07 7G1,5 C KIT	1
8	6019362	cable trumpet 42T 15m H07 7G1,5 C KIT	1
9	6037455	cable trumpet 42T 10m NSS 4x1,5 C KIT	1
9	6019374	cable trumpet 42T 15m NSS 4x2,5 C KIT	1
9	6019381	cable trumpet 42T 10m NSS 7x1,5 C KIT	1
9	6019382	cable trumpet 42T 15m NSS 7x1,5 C KIT	1
9	6037454	cable trumpet 42T 10m NSS 7x2,5 C KIT	1
9	6019387	cable trumpet 42T 20m NSS 7x2,5 C KIT	1
9	6079792	cable trumpet 42T 30m NSS 7x2,5 C KIT	1
10	6019849	cable trumpet 42T RF 10m H07 7G1,5 KIT	1
10	6035148	cable trumpet 42T RF 15m H07 7G1,5 KIT	1
10	6038689	cable trumpet 42T RF 20m H07 7G1,5 KIT	1
11	6032612	cable trumpet 42T RF 10m NSS 7x1,5 KIT	1
11	6034277	cable trumpet 42T RF 30m NSS 7x1,5 KIT	1

cable trumpet 42T KIT

Item	Article no.	Description	Quantity
12	6044717	plug 42T KIT	1
13	6070010	cable trumpet 42T 15m NSSHC 3x16+3x2,5	1
14	6044834	cable trumpet 42T 10m NSS 4x16 KIT	1
14	6067480	cable trumpet 42T 15m NSS 4x16 KIT	1
14	6066168	cable trumpet 42T 20m NSS 4x16 KIT	1
14	6069678	cable trumpet 42T 25m NSS 4x16 KIT	1
14	6081974	cable trumpet 42T 40m NSS 4x16 KIT	1
15	6063562	cable trumpet 42T 40m S07RC4N-F 4x16	1
16	6067560	cable trumpet 42T 20m 4* AWG6	1

KS220MH

Bm0

S/N < 650118681

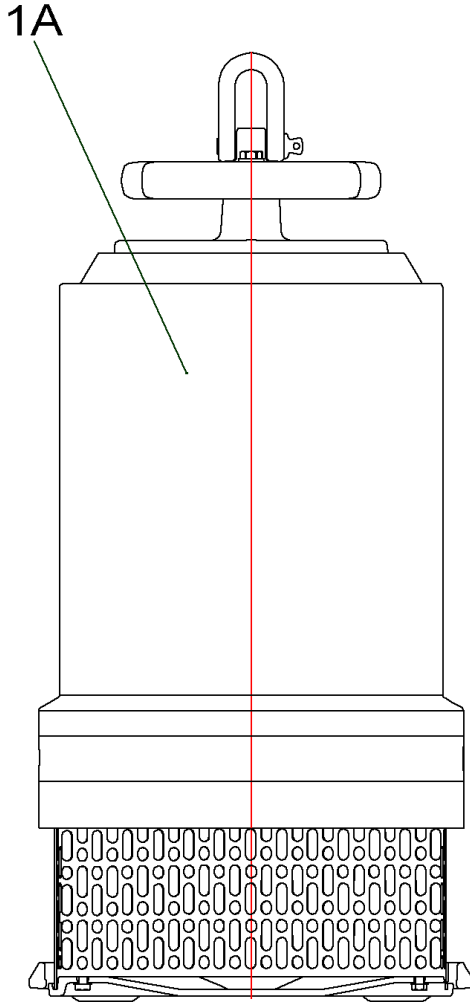

Bm1

S/N > 650118682

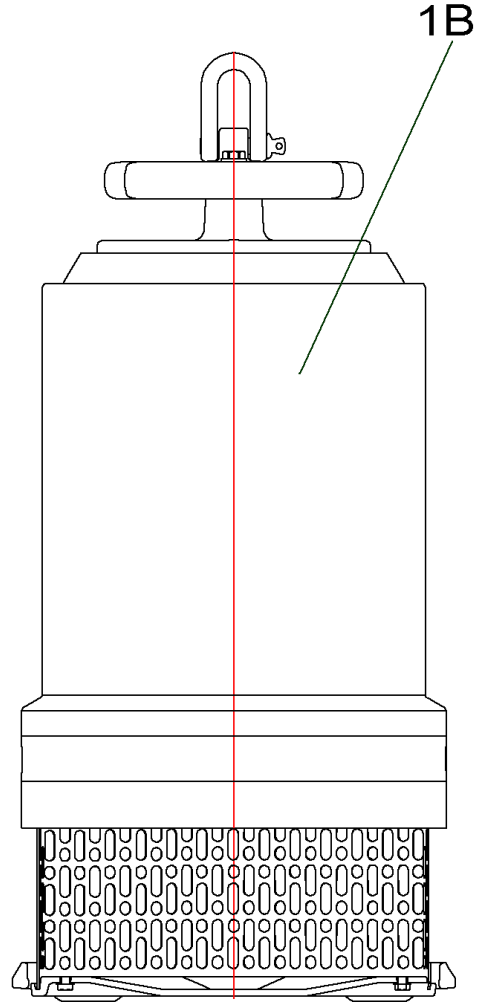

CONTRACTOR'S PUMP KS220MH UNIT (6000092)

Item	Description	Quantity
1A	CONTRACTOR'S PUMP KS220MH (Bm0)	1
1B	CONTRACTOR'S PUMP KS220MH (Bm1)	1

CONTRACTOR'S PUMP KS220MH (Bm0)

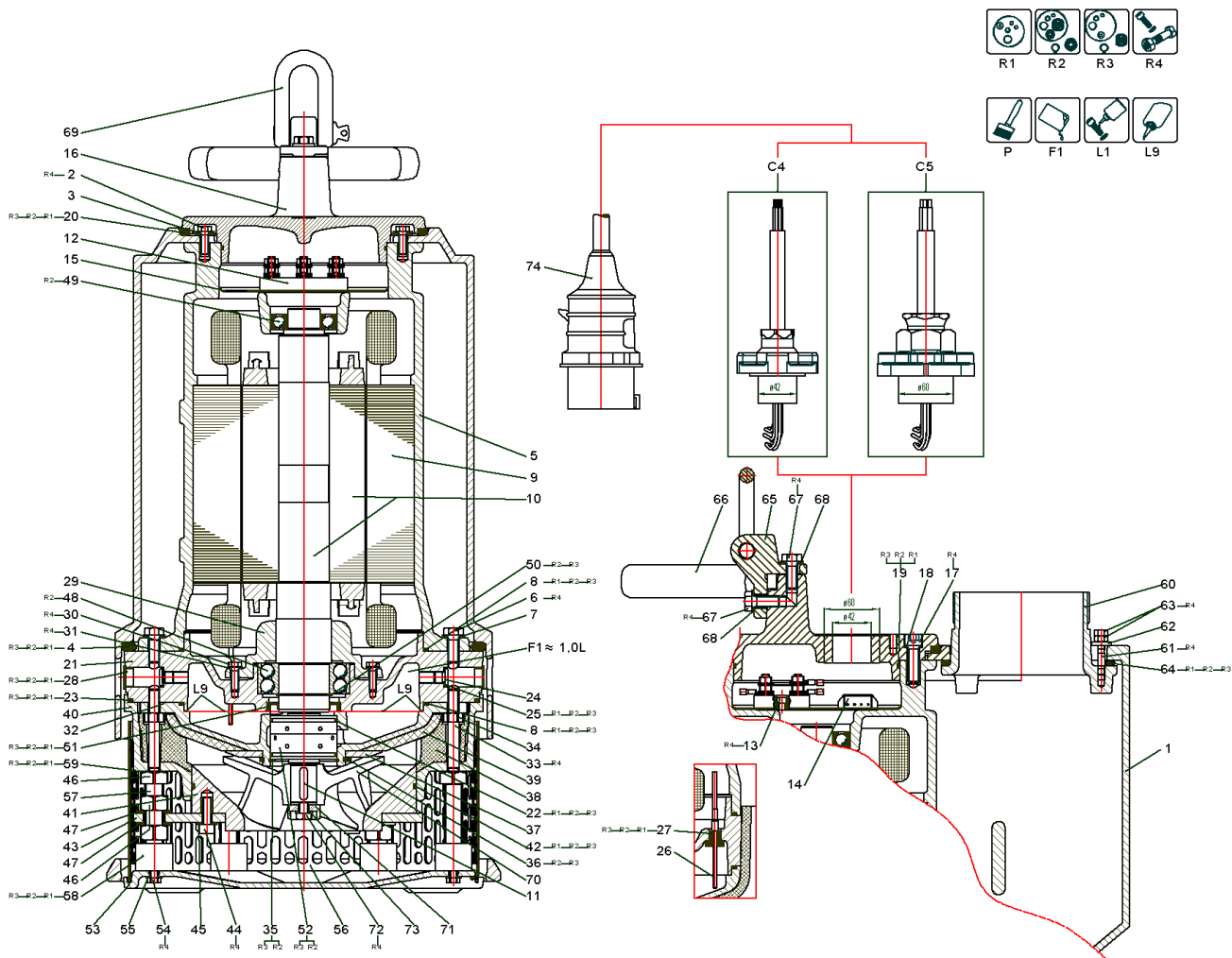

CONTRACTOR'S PUMP KS220MH (Bm0)

Item	Article no.	Description	Quantity
R1	6016273	Rep.Kit 1 KS220 Vit	1
R2	6016288	Rep.Kit 2 KS220 Vit	1
R3	6016321	Rep.Kit 3 KS220 Vit	1
R4	6016127	Screws KS220 KIT	1
P	6042254	PAINT SPRAY Pantone334	1
P	6042255	colour 2K-paint IV80 pantone334C 250ml	1
P	6023614	Ceram C0 black 100 ml KIT	1
P	6020579	Ceram C0 black 250 ml KIT	1
P	6023485	Ceram C0 Black 500ml Kit	1
P	6019157	Ceram C0 black 1000 ml KIT	1
F1	6025460	medical white oil 1L KIT	1
F1	6025461	medical white oil 5L KIT	1
L1	6080531	Loctite 243 5g flask VP:	1
L1	2096167	Loctite 243 50ml VP.	1
L9	6080535	Loctite 5203 300ml VP.	1

C5		cable trumpet 60T KIT	1
C4		cable trumpet 42T KIT	2

1	6017268	pump shroud SG6 50.17861 Al/C0 alternativ / alternative / alternative	1
1	6032053	pump shroud SG6 50.17861 3.1371.61/C0	1
2		screw M8x25 DIN933 A4-70 (10pc)	1
3		washer 8,4 DIN7349 A4 (10pc)	1
4		o-ring ID.360,0x15,0 NBR55	1
5		motor casing 51.17863 Al	1
Note: auf Anfrage / on request / sur demande			
6		screw M12x30 DIN933 A4-70	6
7		washer A13 DIN125 A4 (20pc)	1
8		o-ring ID.255,0x4,0 Viton	1
9	6081415	Stator T24-2/21 400/690 50 PTC110° VP.	1
10	6010512	rotor D.133,5x537 2/21 1.4021 alternativ / alternative / alternative	1
10	6042221	rotor D.133,5x537 2/21 4021/4462 g	1

CONTRACTOR'S PUMP KS220MH (Bm0)

Item	Article no.	Description	Quantity
11	6076643	key A 8x5x36 DIN6885 A4 VP.	1
12	6070362	terminal board 6pol. konf.	1
13		screw M6x16 DIN912 A4 (10pc)	1
14	6002712	connectors pin strip 4-polig	1
15	6010193	cover disc D.182 54.18083 MVL-UE 1x Ø 60mm gebohrt / drilled / percé	1
16	6010758	motor cover D.60 51.17865 GG/C0 2xØ 42mm gebohrt / drilled / percé	1
16	6010757	motor cover D.42 51.17865 GG/C0	1
17		screw M12x40 DIN912 A4-70 (10pc)	1
18		lock washer 12 DIN7980 A4	4
19		o-ring ID.170,0x3,0 NBR70	1
20		o-ring ID.250,0x8,0 NBR70	1
21	6010652	bearing housing 51.17867 GG/C0	1
8		o-ring ID.255,0x4,0 Viton	1
23		O-Ring ID.360,0x4,0 Viton 75 VP.	1
24	6002435	screw plug G1/4 A DIN908 A4	2
25	6007522	seal ring A14/18x1,5 DIN7603 PA	2
26	6017145	electrode rod D.4x77 54.13422 A2	2
27	6078171	sealing plug 13421 NBR 80 VP.	2
28	6007419	plug GPN300 F19 Plastik	2
29	6010648	bearing cover D.110H7 52.17868 Al	1
30		screw M8x25 DIN933 A4-70 (10pc)	1
31		washer A8,4 DIN125 1.4401 (20pc)	1
32	6010622	sealing flange D.355 51.17870 Al/C0	1
33		screw M12x85 DIN939 A2-70	6
34		nut M12 DIN934 A4-80 (10pcs)	1
35	6002185	circlips 72x2,5 DIN472 A2	1
36	6002053	circlips 90x3 DIN471 A2	1
37	6016948	washer D.90/170x7 54.18086 1.4301	1
38	6004315	guide casing 17872 PUR raw	1
39	6004703	wear plate 17873 PUR raw	1
40	6010927	pump housing A 51.17874 Al/C0	1
41	6010646	suction port D.244 52.17875 PA12G	1

CONTRACTOR'S PUMP KS220MH (Bm0)

Item	Article no.	Description	Quantity
42		o-ring ID.230,0x4,0 NBR70	1
43	6004347	supporting plate 53.18082 1.4301	1
44		screw M10x30 ISO4762 A4-70	3
45		Washer A10,5 DIN125 A4 (20pcs)	1
46		nut M20 DIN934 A4-80 (10pc)	1
47		WASHER A21 DIN125 A4 (10pc)	1
48	6081300	ball bearing 5211 VP.	1
49	6081345	ball bearing 6207 w.2 Dichtschr. VP.	1
50	6081303	Circlip 55x2 DIN471 FSt VP.	1
51	6007473	shaft seal ring B55/80x10 Domsel NBR+A2	1
52	6074592	shaft sealing H35/2 VP.	1
		alternativ / alternative / alternative	
52	6075005	shaft sealing H35/2 1.4462 VP.	1
22	6080478	o-ring ID.65,0x3,0 Viton molyk.70 (2pc)	1
53	6017267	base plate D.392 51.17882 Al/C0	1
54		screw M8x16 DIN933 A4-70	6
55		washer A8,4 DIN125 1.4401 (20pc)	1
56	6004875	strainer 175x380x2 51.17883 1.4301	1
57	6010755	spacer M20x65 DIN933 54.17884 A4	6
58	6002685	rubber buffer Tiegler B/GM40 NB	6
59		Dubo-washer M12 NR.207 PA	6
60	6010756	discharge piece G6 52.17885 GGG/C0	1
61		screw M8x40 DIN939 A4	4
62		washer 8,4 DIN7349 A4 (10pc)	1
63		nut M8 DIN934 A4	8
64		O-RING ID.184X8N DIN3771 NBR70	1
65	6017259	handle 52.17887 1.4581	1
66	6003986	handle 52.17333 St-Gummi	1
67		screw M12x30 DIN933 A4-70	2
68		washer A13 DIN125 A4 (20pc)	1
69	6003030	shackle 16mm 1.4401	1
		Laufrad / Impeller / Roue 50Hz	
70	6033182	impeller-H/MH D.230 52.17966 Abrasit	1
		Laufrad / Impeller / Roue 60Hz	

CONTRACTOR'S PUMP KS220MH (Bm0)

Item	Article no.	Description	Quantity
70	6033183	impeller-H/MH D.208 52.17966 Abrasit	1
71	6011711	washer D.35/11x16 55.1865 1.4021	1
		alternativ / alternative / alternative	
71	6011710	washer D.35/11x16 55.1865 1.4462	1
72	6003623	screw M10x30 DIN933 10.9 Geomet	1
73	2043863	SCREW LOCKING NORD-LOCK 16/10,7 A4	1
74	6003012	plug CEE63A/400V/5P-6H/IP67	1

cablE trumpet 60T KIT

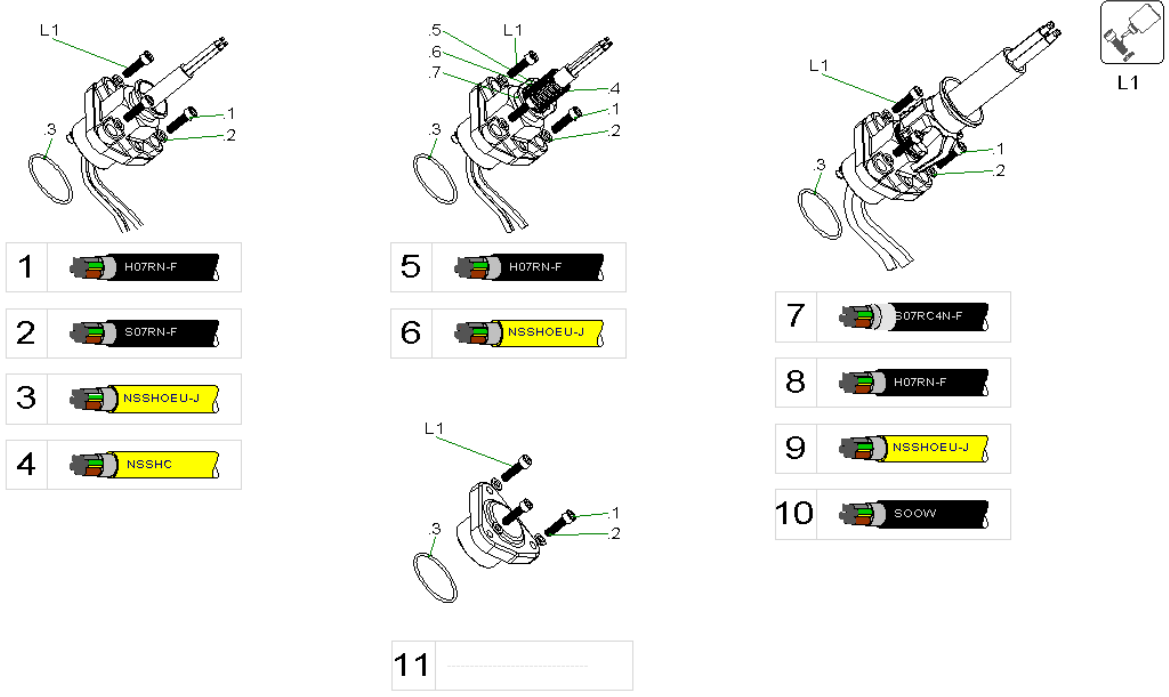

cable trumpet 60T KIT

Item	Article no.	Description	Quantity
L1	6080531	Loctite 243 5g flask VP:	1
.1	6078159	screw M8x30 DIN912 A4-70 (10pc)	3
.2	6078161	shim ring 8x14x1,0 DIN988 A2 (10pc)	3
.3	6007747	o-ring ID.60,0x3,0 NBR70	1
.4	6062009	protecting cover 42,5/35,5 PA6	
.5	6017168	screw cap D.29 54.13974 1.4401	1
.6	6078163	o-ring ID.20,0x3,0 Viton 75 (3pc)	1
.7	6017170	screwed hose connection Pg29 55.13614 1.	1
1	6001513	cable trumpet 60T 20m H07 4x1,5 KIT	1
1	6001535	cable trumpet 60T 10m H07 10x1,5 KIT	1
2	6035224	cable trumpet 60T 20m S07RN-F 4G6(4x1)	1
2	6045369	cable trumpet 60T 50m S07RN-F 4G6(4x1)	1
3	6001346	cable trumpet 60T 5m NSS 4x1,5 KIT	1
3	6001347	cable trumpet 60T 10m NSS 4x1,5 KIT	1
3	6001348	cable trumpet 60T 15m NSS 4x1,5 KIT	1
3	6001349	cable trumpet 60T 20m NSS 4x1,5 KIT	1
3	6001354	cable trumpet 60T 5m NSS 4x2,5 KIT	1
3	6001355	cable trumpet 60T 10m NSS 4x2,5 KIT	1
3	6001356	cable trumpet 60T 15m NSS 4x2,5 KIT	1
3	6001357	cable trumpet 60T 20m NSS 4x2,5 KIT	1
3	6001358	cable trumpet 60T 5m NSS 4x4 KIT	1
3	6001359	cable trumpet 60T 10m NSS 4x4 KIT	1
3	6001360	Cable Trumpet 60T 15m NSS 4x4 KIT	1
3	6001361	cable trumpet 60T 20m NSS 4x4 KIT	1
3	6042246	cable trumpet 60T 25m NSS 4x4 KIT	1
3	6001482	cable trumpet 60T 5m NSS 4x6 KIT	1
3	6001483	Leitungsdurchf. 60T 10m NSS 4x6 SET	1
3	6001484	cable trumpet 60T 15M NSS 4x6 KIT	1
3	6001485	cable trumpet 60T 20m NSS 4x6 KIT	1
3	6001486	cable trumpet 60T 5m NSS 4x10 KIT	1
3	6001487	cable trumpet 60T 10M NSS 4x10 KIT	1
3	6001488	cable trumpet 60T 15m NSS 4x10 KIT	1
3	6001489	cable trumpet 60T 20m NSS 4x10 KIT	1
3	6001364	cable trumpet 60T 5m NSS 7x1,5 KIT	1

cable trumpet 60T KIT

Item	Article no.	Description	Quantity
3	6001365	cable trumpet 60T 10m NSS 7x1,5 KIT	1
3	6001366	cable trumpet 60T 15m NSS 7x1,5 KIT	1
3	6001367	cable trumpet 60T 20m NSS 7x1,5 KIT	1
3	6001335	cable trumpet 60T 5m NSS 7x2,5 KIT	1
3	6001334	cable trumpet 60T 10m NSS 7x2,5 KIT	1
3	6001336	cable trumpet 60T 15m NSS 7x2,5 KIT	1
3	6001337	cable trumpet 60T 20m NSS 7x2,5 KIT	1
3	6020377	cable trumpet 60T 25m NSS 7x2,5 KIT	1
3	6038669	cable trumpet 60T 50m NSS 7x2,5 KIT	1
3	6001368	cable trumpet 60T 5m NSS 10x1,5 KIT	1
3	6001369	cable trumpet 60T 10m NSS 10x1,5 KIT	1
3	6001480	cable trumpet 60T 15m NSS 10x1,5 KIT	1
3	6001481	cable trumpet 60T 20m NSS 10x1,5 KIT	1
4	6070013	cable trumpet 60T 15m NSSHC 3x16+3x2,5	1
6	6067482	cable trumpet 60T 10m NSS 4x10 C KIT	1
6	6039693	cable trumpet 60T 10m NSS 7x2,5 C KIT	1
7	6081596	cable trumpet 60T 10m S07RC4N-F 4G4	1
7	6085233	cable trumpet 60T 15m S07RC4N-F 4G4	1
7	6026674	cable trumpet 60T 20m S07RC4N-F 4G4	1
7	6066387	cable trumpet 60T 10m S07RC4N8-F 4G16	1
7	6061984	cable trumpet 60T 15m S07RC4N8-F 4G16	1
7	6063564	cable trumpet 60T 40m S07RC4N8-F 4G16	1
7	6085234	cable trumpet 60T 15m S07RC4N8-F 4G25	1
9	6001490	cable trumpet 60T 5m NSS 4x16 KIT	1
9	6001491	cable trumpet 60T 10m NSS 4x16 KIT	1
9	6001492	cable trumpet 60T 15m NSS 4x16 KIT	1
9	6001493	cable trumpet 60T 20m NSS 4x16 KIT	1
9	6021510	cable trumpet 60T 30m NSS 4x16 KIT	1
9	6042287	cable trumpet 60T 60m NSS 4x16 KIT	1
9	6001494	cable trumpet 60T 5m NSS 4x25 KIT	1
9	6001495	cable trumpet 60T 10m NSS 4x25 KIT	1
9	6001496	cable trumpet 60T 15m NSS 4x25 KIT	1
9	6001497	cable trumpet 60T 20m NSS 4x25 KIT	1
9	6034270	cable trumpet 60T 30m NSS 4x25 KIT	1

cable trumpet 60T KIT

Item	Article no.	Description	Quantity
9	6070758	cable trumpet 60T 40m NSS 4x25 KIT	1
10	6065154	cable trumpet 60T 10m 4* AWG4	1
10	6065155	cable trumpet 60T 20m 4* AWG4	1
11	6044718	plug 60T KIT	1

cablE trumpet 42T KIT

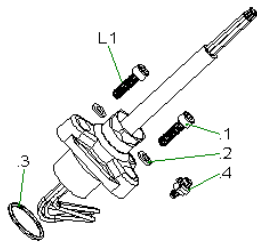

- 1 H07RN-F
- 2 S07RN-F
- 3 NSSHOEU-J
- 4 S07RC4N-F
- 5 SOOW
- 6 NSSHC0U-J

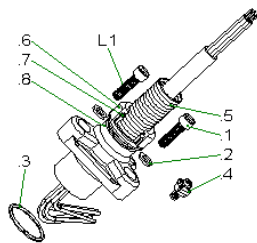

- 7 S07RC4N-F
- 8 H07RN-F
- 9 NSSHOEU-J
- 10 H07RN-F
- 11 NSSHOEU-J

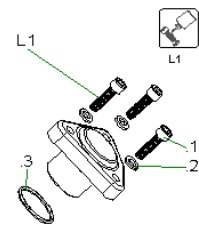
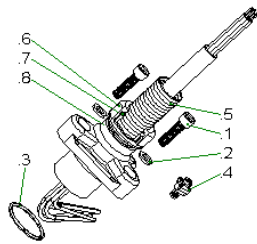

- 12 -----

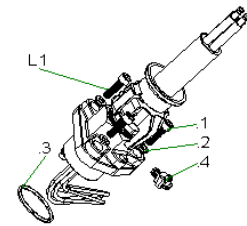

- 13 NSSHC0U-J
- 14 NSSHOEU-J
- 15 S07RC4N-F
- 16 SOOW

cable trumpet 42T KIT

Item	Article no.	Description	Quantity
L1	6080531	Loctite 243 5g flask VP:	1
.1	6078159	screw M8x30 DIN912 A4-70 (10pc)	3
.2	6078161	shim ring 8x14x1,0 DIN988 A2 (10pc)	3
.3	6078162	o-ring ID.40,0x3,0 Viton (3pc)	1
.4	6067407	Barlian bow terminal M5 A2	1
.5	6007918	protecting hose 28,5/22,8 PA6	
.6	6017168	screw cap D.29 54.13974 1.4401	1
.7	6078163	o-ring ID.20,0x3,0 Viton 75 (3pc)	1
1	6000688	cable trumpet 42T 5m H07 7G1,5 KIT	1
1	6000689	CABLE TRUMPET 42T 10M H07 7G1,5 KIT	1
1	6000690	cable trumpet 42T 15m H07 7G1,5 KIT	1
1	6000691	cable trumpet 42T 20m H07 7G1,5 SET	1
1	6024687	cable trumpet 42T 25m H07 7G1,5 KIT	1
1	6032527	cable trumpet 42T 30m H07 7G1,5 KIT	1
1	6066420	cable trumpet 42T 35m H07 7G1,5 KIT	1
1	6000692	cable trumpet 42T 5m H07 10G1,5 KIT	1
1	6001115	cable trumpet 42T 10m H07 10G1,5 KIT	1
1	6000693	cable trumpet 42T 15m H07 10G1,5 KIT	1
1	6000694	cable trumpet 42T 20m H07 10G1,5 KIT	1
1	6046176	cable trumpet 42T 25m H07 10G1,5 KIT	1
2	6038293	cable trumpet 42T 10m S07RN-F 4G6(4x1)	1
3	6000699	cable trumpet 42T 5m NSS 2x1,5 KIT	1
3	6000700	cable trumpet 42T 10m NSS 2x1,5 KIT	1
3	6000701	cable trumpet 42T 15m NSS 2x1,5 KIT	1
3	6000702	cable trumpet 42T 20m NSS 2x1,5 KIT	1
3	6075910	cable trumpet 42T 25m NSS 2x1,5 KIT	1
3	6061578	cable trumpet 42T 30m NSS 2x1,5 KIT	1
3	6065996	cable trumpet 42T 45m NSS 2x1,5 KIT	1
3	6000703	cable trumpet 42T 5m NSS 4x1,5 KIT	1
3	6000704	cable trumpet 42T 10m NSS 4x1,5 KIT	1
3	6000705	Cable Trumpet 42T 15m NSS 4x1,5 KIT	1
3	6000706	cable trumpet 42T 20m NSS 4x1,5 KIT	1
3	6020376	cable trumpet 42T 25m NSS 4x1,5 KIT	1
3	6019867	cable trumpet 42T 30m NSS 4x1,5 KIT	1

cable trumpet 42T KIT

Item	Article no.	Description	Quantity
3	6036907	cable trumpet 42T 35m NSS 4x1,5 KIT	1
3	6038670	cable trumpet 42T 50m NSS 4x1,5 KIT	1
3	6040496	cable trumpet 42T 60m NSS 4x1,5 KIT	1
3	6000707	cable trumpet 42T 5m NSS 4x2,5 KIT	1
3	6000708	cable trumpet 42T 10m NSS 4x2,5 KIT	1
3	6000709	cable trumpet 42T 15m NSS 4x2,5 KIT	1
3	6001426	cable trumpet 42T 20m NSS 4x2,5 KIT	1
3	6066888	cable trumpet 42T 25m NSS 4x2,5 KIT	1
3	6001427	cable trumpet 42T 5m NSS 4x4 KIT	1
3	6001428	cable trumpet 42T 10m NSS 4x4 KIT	1
3	6001429	cable trumpet 42T 15m NSS 4x4 KIT	1
3	6001430	cable trumpet 42T 20m NSS 4x4 KIT	1
3	6075909	cable trumpet 42T 25m NSS 4x4 KIT	1
3	6067861	cable trumpet 42T 30m NSS 4x4 KIT	1
3	6072786	cable trumpet 42T 10m NSS 4x6 KIT	1
3	6066425	cable trumpet 42T 15m NSS 4x6 KIT	1
3	6068990	cable trumpet 42T 20m NSS 4x6 KIT	1
3	6065995	cable trumpet 42T 30m NSS 4x6 KIT	1
3	6065994	cable trumpet 42T 45m NSS 4x6 KIT	1
3	6040497	cable trumpet 42T 60m NSS 4x6 KIT	1
3	6044835	cable trumpet 42T 10m NSS 4x10 KIT	1
3	6067481	cable trumpet 42T 15m NSS 4x10 KIT	1
3	6070122	cable trumpet 42T 30m NSS 4x10 KIT	1
3	6001431	cable trumpet 42T 5m NSS 7x1,5 KIT	1
3	6001432	cable trumpet 42T 10m NSS 7x1,5 KIT	1
3	6001433	cable trumpet 42T 15m NSS 7x1,5 KIT	1
3	6001434	cable trumpet 42T 20m NSS 7x1,5 KIT	1
3	6040684	cable trumpet 42T 25m NSS 7x1,5 KIT	1
3	6074636	cable trumpet 42T 40m NSS 7x1,5 KIT	1
3	6001435	cable trumpet 42T 5m NSS 7x2,5 KIT	1
3	6001436	cable trumpet 42T 10M NSS 7x2,5 KIT	1
3	6001437	cable trumpet 42T 15m NSS 7x2,5 KIT	1
3	6001438	cable trumpet 42T 20m NSS 7x2,5 KIT	1
3	6036937	cable trumpet 42T 25m NSS 7x2,5 KIT	1

cable trumpet 42T KIT

Item	Article no.	Description	Quantity
3	6036906	cable trumpet 42T 35m NSS 7x2,5 KIT	1
3	6086145	cable trumpet 42T 10m NSS 10x1,5 SET	1
3	6068144	cable trumpet 42T 15m NSS 10x1,5 KIT	1
3	6078651	cable trumpet 42T 20m NSS 10x1,5 SET	1
3	6078807	cable trumpet 42T 25m NSS 10x1,5 SET	1
4	6046317	cable trumpet 42T 10m S07RC4N-F 4x1,5	1
4	6063563	cable trumpet 42T 40m S07RC4N-F 4x1,5	1
4	6066388	cable trumpet 42T 10m S07RC4N-F 7x1,5KIT	1
4	6061983	cable trumpet 42T 15m S07RC4N-F 4x1,5KIT	1
4	6046316	cable trumpet 42T 20m S07RC4N-F 4x4	1
5	6065152	cable trumpet 42T 10m 2* AWG14	1
5	6065153	cable trumpet 42T 20m 2* AWG14	1
5	6066488	cable trumpet 42T 20m 4* AWG14	1
5	6065151	cable trumpet 42T 10m 7* AWG14	1
5	6066489	cable trumpet 42T 20m 7* AWG14	1
5	6065150	cable trumpet 42T 10m 4* AWG10	1
6	2132620	on request	1

7	6067898	cable trumpet 42T 10m S07RC4N-F 12G1,5 C	1
8	6019360	cable trumpet 42T 5m H07 7G1,5 C KIT	1
8	6019362	cable trumpet 42T 15m H07 7G1,5 C KIT	1
9	6037455	cable trumpet 42T 10m NSS 4x1,5 C KIT	1
9	6019374	cable trumpet 42T 15m NSS 4x2,5 C KIT	1
9	6019381	cable trumpet 42T 10m NSS 7x1,5 C KIT	1
9	6019382	cable trumpet 42T 15m NSS 7x1,5 C KIT	1
9	6037454	cable trumpet 42T 10m NSS 7x2,5 C KIT	1
9	6019387	cable trumpet 42T 20m NSS 7x2,5 C KIT	1
9	6079792	cable trumpet 42T 30m NSS 7x2,5 C KIT	1
10	6019849	cable trumpet 42T RF 10m H07 7G1,5 KIT	1
10	6035148	cable trumpet 42T RF 15m H07 7G1,5 KIT	1
10	6038689	cable trumpet 42T RF 20m H07 7G1,5 KIT	1
11	6032612	cable trumpet 42T RF 10m NSS 7x1,5 KIT	1
11	6034277	cable trumpet 42T RF 30m NSS 7x1,5 KIT	1

cable trumpet 42T KIT

Item	Article no.	Description	Quantity
12	6044717	plug 42T KIT	1
13	6070010	cable trumpet 42T 15m NSSHC 3x16+3x2,5	1
14	6044834	cable trumpet 42T 10m NSS 4x16 KIT	1
14	6067480	cable trumpet 42T 15m NSS 4x16 KIT	1
14	6066168	cable trumpet 42T 20m NSS 4x16 KIT	1
14	6069678	cable trumpet 42T 25m NSS 4x16 KIT	1
14	6081974	cable trumpet 42T 40m NSS 4x16 KIT	1
15	6063562	cable trumpet 42T 40m S07RC4N-F 4x16	1
16	6067560	cable trumpet 42T 20m 4* AWG6	1

CONTRACTOR'S PUMP KS220MH (Bm1)

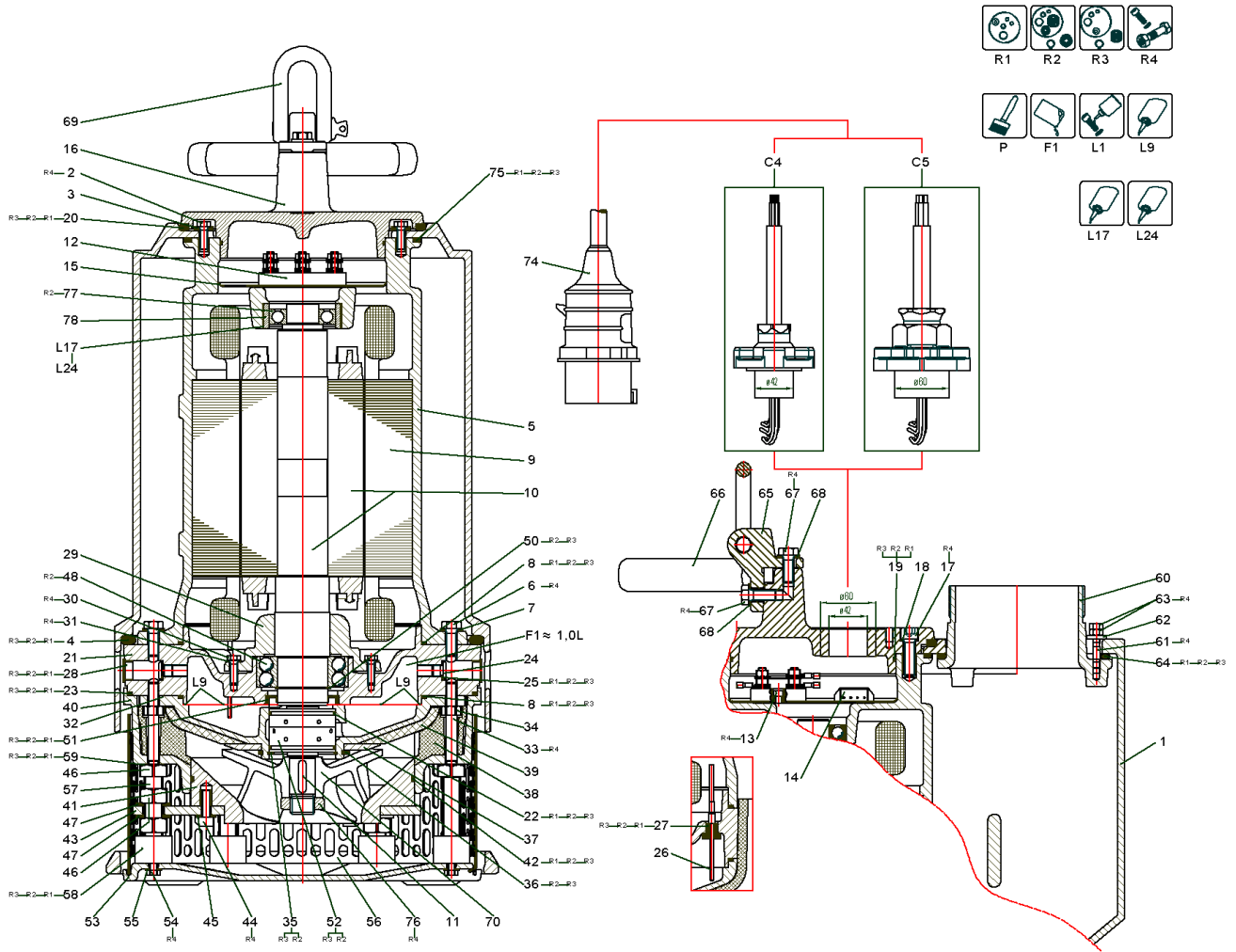

CONTRACTOR'S PUMP KS220MH (Bm1)

Item	Article no.	Description	Quantity
R1	6016273	Rep.Kit 1 KS220 Vit	1
R2	6016288	Rep.Kit 2 KS220 Vit	1
R3	6016321	Rep.Kit 3 KS220 Vit	1
R4	6016127	Screws KS220 KIT	1
P	6042254	PAINT SPRAY Pantone334	1
P	6042255	colour 2K-paint IV80 pantone334C 250ml	1
P	6023614	Ceram C0 black 100 ml KIT	1
P	6020579	Ceram C0 black 250 ml KIT	1
P	6023485	Ceram C0 Black 500ml Kit	1
P	6019157	Ceram C0 black 1000 ml KIT	1
F1	6025460	medical white oil 1L KIT	1
F1	6025461	medical white oil 5L KIT	1
L1	6080531	Loctite 243 5g flask VP:	1
L1	2096167	Loctite 243 50ml VP.	1
L9	6080535	Loctite 5203 300ml VP.	1
L17		Loctite 7649 500ml	1
L24	6063947	Loctite 3504 50ml	1

C5		cable trumpet 60T KIT	1
C4		cable trumpet 42T KIT	2

1	6017268	pump shroud SG6 50.17861 Al/C0	1
		alternativ / alternative / alternative	
1	6032053	pump shroud SG6 50.17861 3.1371.61/C0	1
2		screw M8x25 DIN933 A4-70 (10pc)	1
3		washer 8,4 DIN7349 A4 (10pc)	1
4		o-ring ID.360,0x15,0 NBR55	1
5		motor casing 51.17863/1 Al	1
Note: auf Anfrage / on request / sur demande			
78		bush D.85/71x27 6050391 1.4462	1
Note: auf Anfrage / on request / sur demande			
75	6063517	o-ring ID.242,0x6,0 Viton	1
6		screw M12x30 DIN933 A4-70	6
7		washer A13 DIN125 A4 (20pc)	1

CONTRACTOR'S PUMP KS220MH (Bm1)

Item	Article no.	Description	Quantity
8		o-ring ID.255,0x4,0 Viton	1
9	6081415	Stator T24-2/21 400/690 50 PTC110° VP.	1
10	6045397	rotor D.133,5x557 2/21 4021/4462 g	1
		alternativ / alternative / alternative	
10	6045395	rotor D.133,5x557 2/21 4021/4462 g	1
76	6038971	nut M27x2,0 DIN439 A2	1
11	6076643	key A 8x5x36 DIN6885 A4 VP.	1
12	6070362	terminal board 6pol. konf.	1
13		screw M6x16 DIN912 A4 (10pc)	1
14	6002712	connectors pin strip 4-polig	1
15	6010193	cover disc D.182 54.18083 MVL-UE	1
		1x Ø 60mm gebohrt / drilled / percè	
16	6010758	motor cover D.60 51.17865 GG/C0	1
		2xØ 42mm gebohrt / drilled / percè	
16	6010757	motor cover D.42 51.17865 GG/C0	1
17		screw M12x40 DIN912 A4-70 (10pc)	1
18		lock washer 12 DIN7980 A4	4
19		o-ring ID.170,0x3,0 NBR70	1
20		o-ring ID.250,0x8,0 NBR70	1
21	6010652	bearing housing 51.17867 GG/C0	1
8		o-ring ID.255,0x4,0 Viton	1
23		O-Ring ID.360,0x4,0 Viton 75 VP.	1
24	6002435	screw plug G1/4 A DIN908 A4	2
25	6007522	seal ring A14/18x1,5 DIN7603 PA	2
26	6017145	electrode rod D.4x77 54.13422 A2	2
27	6078171	sealing plug 13421 NBR 80 VP.	2
28	6007419	plug GPN300 F19 Plastik	2
29	6010648	bearing cover D.110H7 52.17868 Al	1
30		screw M8x25 DIN933 A4-70 (10pc)	1
31		washer A8,4 DIN125 1.4401 (20pc)	1
32	6010622	sealing flange D.355 51.17870 Al/C0	1
33		screw M12x85 DIN939 A2-70	6
34		nut M12 DIN934 A4-80 (10pcs)	1
35	6002185	circlips 72x2,5 DIN472 A2	1

CONTRACTOR'S PUMP KS220MH (Bm1)

Item	Article no.	Description	Quantity
36	6002053	circlips 90x3 DIN471 A2	1
37	6016948	washer D.90/170x7 54.18086 1.4301	1
38	6004315	guide casing 17872 PUR raw	1
39	6004703	wear plate 17873 PUR raw	1
40	6010927	pump housing A 51.17874 Al/C0	1
41	6010646	suction port D.244 52.17875 PA12G	1
42		o-ring ID.230,0x4,0 NBR70	1
43	6004347	supporting plate 53.18082 1.4301	1
44		screw M10x30 ISO4762 A4-70	3
45		Washer A10,5 DIN125 A4 (20pcs)	1
46		nut M20 DIN934 A4-80 (10pc)	1
47		WASHER A21 DIN125 A4 (10pc)	1
48	6081300	ball bearing 5211 VP.	1
77	6081345	ball bearing 6207 w.2 Dichts. VP.	1
50	6081303	Circlip 55x2 DIN471 FSt VP.	1
51	6007473	shaft seal ring B55/80x10 Domsel NBR+A2	1
52	6074592	shaft sealing H35/2 VP.	1
		alternativ / alternative / alternative	
52	6075005	shaft sealing H35/2 1.4462 VP.	1
22	6080478	o-ring ID.65,0x3,0 Viton molyk.70 (2pc)	1
53	6017267	base plate D.392 51.17882 Al/C0	1
54		screw M8x16 DIN933 A4-70	6
55		washer A8,4 DIN125 1.4401 (20pc)	1
56	6004875	strainer 175x380x2 51.17883 1.4301	1
57	6010755	spacer M20x65 DIN933 54.17884 A4	6
58	6002685	rubber buffer Tiegler B/GM40 NB	6
59		Dubo-washer M12 NR.207 PA	6
60	6010756	discharge piece G6 52.17885 GGG/C0	1
61		screw M8x40 DIN939 A4	4
62		washer 8,4 DIN7349 A4 (10pc)	1
63		nut M8 DIN934 A4	8
64		O-RING ID.184X8N DIN3771 NBR70	1
65	6017259	handle 52.17887 1.4581	1
66	6003986	handle 52.17333 St-Gummi	1

CONTRACTOR'S PUMP KS220MH (Bm1)

Item	Article no.	Description	Quantity
67		screw M12x30 DIN933 A4-70	2
68		washer A13 DIN125 A4 (20pc)	1
69	6003030	shackle 16mm 1.4401	1
		Laufrad / Impeller / Roue 50Hz	
70	6033182	impeller-H/MH D.230 52.17966 Abrasit	1
		Laufrad / Impeller / Roue 60Hz	
70	6033183	impeller-H/MH D.208 52.17966 Abrasit	1
74	6003012	plug CEE63A/400V/5P-6H/IP67	1

cablE trumpet 60T KIT

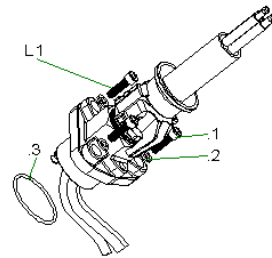
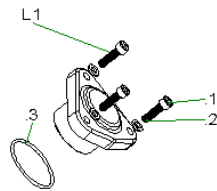
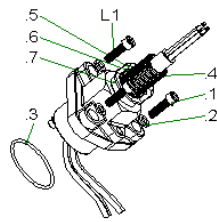
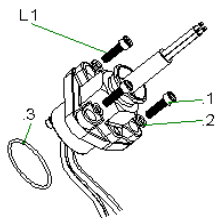

cable trumpet 60T KIT

Item	Article no.	Description	Quantity
L1	6080531	Loctite 243 5g flask VP:	1
.1	6078159	screw M8x30 DIN912 A4-70 (10pc)	3
.2	6078161	shim ring 8x14x1,0 DIN988 A2 (10pc)	3
.3	6007747	o-ring ID.60,0x3,0 NBR70	1
.4	6062009	protecting cover 42,5/35,5 PA6	
.5	6017168	screw cap D.29 54.13974 1.4401	1
.6	6078163	o-ring ID.20,0x3,0 Viton 75 (3pc)	1
.7	6017170	screwed hose connection Pg29 55.13614 1.	1
1	6001513	cable trumpet 60T 20m H07 4x1,5 KIT	1
1	6001535	cable trumpet 60T 10m H07 10x1,5 KIT	1
2	6035224	cable trumpet 60T 20m S07RN-F 4G6(4x1)	1
2	6045369	cable trumpet 60T 50m S07RN-F 4G6(4x1)	1
3	6001346	cable trumpet 60T 5m NSS 4x1,5 KIT	1
3	6001347	cable trumpet 60T 10m NSS 4x1,5 KIT	1
3	6001348	cable trumpet 60T 15m NSS 4x1,5 KIT	1
3	6001349	cable trumpet 60T 20m NSS 4x1,5 KIT	1
3	6001354	cable trumpet 60T 5m NSS 4x2,5 KIT	1
3	6001355	cable trumpet 60T 10m NSS 4x2,5 KIT	1
3	6001356	cable trumpet 60T 15m NSS 4x2,5 KIT	1
3	6001357	cable trumpet 60T 20m NSS 4x2,5 KIT	1
3	6001358	cable trumpet 60T 5m NSS 4x4 KIT	1
3	6001359	cable trumpet 60T 10m NSS 4x4 KIT	1
3	6001360	Cable Trumpet 60T 15m NSS 4x4 KIT	1
3	6001361	cable trumpet 60T 20m NSS 4x4 KIT	1
3	6042246	cable trumpet 60T 25m NSS 4x4 KIT	1
3	6001482	cable trumpet 60T 5m NSS 4x6 KIT	1
3	6001483	Leitungsdurchf. 60T 10m NSS 4x6 SET	1
3	6001484	cable trumpet 60T 15M NSS 4x6 KIT	1
3	6001485	cable trumpet 60T 20m NSS 4x6 KIT	1
3	6001486	cable trumpet 60T 5m NSS 4x10 KIT	1
3	6001487	cable trumpet 60T 10M NSS 4x10 KIT	1
3	6001488	cable trumpet 60T 15m NSS 4x10 KIT	1
3	6001489	cable trumpet 60T 20m NSS 4x10 KIT	1
3	6001364	cable trumpet 60T 5m NSS 7x1,5 KIT	1

cable trumpet 60T KIT

Item	Article no.	Description	Quantity
3	6001365	cable trumpet 60T 10m NSS 7x1,5 KIT	1
3	6001366	cable trumpet 60T 15m NSS 7x1,5 KIT	1
3	6001367	cable trumpet 60T 20m NSS 7x1,5 KIT	1
3	6001335	cable trumpet 60T 5m NSS 7x2,5 KIT	1
3	6001334	cable trumpet 60T 10m NSS 7x2,5 KIT	1
3	6001336	cable trumpet 60T 15m NSS 7x2,5 KIT	1
3	6001337	cable trumpet 60T 20m NSS 7x2,5 KIT	1
3	6020377	cable trumpet 60T 25m NSS 7x2,5 KIT	1
3	6038669	cable trumpet 60T 50m NSS 7x2,5 KIT	1
3	6001368	cable trumpet 60T 5m NSS 10x1,5 KIT	1
3	6001369	cable trumpet 60T 10m NSS 10x1,5 KIT	1
3	6001480	cable trumpet 60T 15m NSS 10x1,5 KIT	1
3	6001481	cable trumpet 60T 20m NSS 10x1,5 KIT	1
4	6070013	cable trumpet 60T 15m NSSHC 3x16+3x2,5	1
6	6067482	cable trumpet 60T 10m NSS 4x10 C KIT	1
6	6039693	cable trumpet 60T 10m NSS 7x2,5 C KIT	1
7	6081596	cable trumpet 60T 10m S07RC4N-F 4G4	1
7	6085233	cable trumpet 60T 15m S07RC4N-F 4G4	1
7	6026674	cable trumpet 60T 20m S07RC4N-F 4G4	1
7	6066387	cable trumpet 60T 10m S07RC4N8-F 4G16	1
7	6061984	cable trumpet 60T 15m S07RC4N8-F 4G16	1
7	6063564	cable trumpet 60T 40m S07RC4N8-F 4G16	1
7	6085234	cable trumpet 60T 15m S07RC4N8-F 4G25	1
9	6001490	cable trumpet 60T 5m NSS 4x16 KIT	1
9	6001491	cable trumpet 60T 10m NSS 4x16 KIT	1
9	6001492	cable trumpet 60T 15m NSS 4x16 KIT	1
9	6001493	cable trumpet 60T 20m NSS 4x16 KIT	1
9	6021510	cable trumpet 60T 30m NSS 4x16 KIT	1
9	6042287	cable trumpet 60T 60m NSS 4x16 KIT	1
9	6001494	cable trumpet 60T 5m NSS 4x25 KIT	1
9	6001495	cable trumpet 60T 10m NSS 4x25 KIT	1
9	6001496	cable trumpet 60T 15m NSS 4x25 KIT	1
9	6001497	cable trumpet 60T 20m NSS 4x25 KIT	1
9	6034270	cable trumpet 60T 30m NSS 4x25 KIT	1

cable trumpet 60T KIT

Item	Article no.	Description	Quantity
9	6070758	cable trumpet 60T 40m NSS 4x25 KIT	1
10	6065154	cable trumpet 60T 10m 4* AWG4	1
10	6065155	cable trumpet 60T 20m 4* AWG4	1
11	6044718	plug 60T KIT	1

cablE trumpet 42T KIT

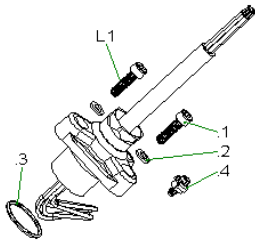

- 1 H07RN-F
- 2 S07RN-F
- 3 NSSHOEU-J
- 4 S07RC4N-F
- 5 SOOW
- 6 NSSHC0U-J

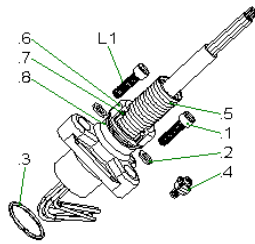

- 7 S07RC4N-F
- 8 H07RN-F
- 9 NSSHOEU-J
- 10 H07RN-F
- 11 NSSHOEU-J

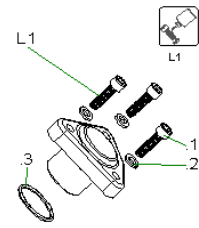
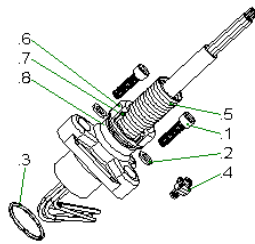

- 12 -----

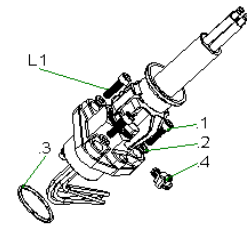

- 13 NSSHC0U-J
- 14 NSSHOEU-J
- 15 S07RC4N-F
- 16 SOOW

cable trumpet 42T KIT

Item	Article no.	Description	Quantity
L1	6080531	Loctite 243 5g flask VP:	1
.1	6078159	screw M8x30 DIN912 A4-70 (10pc)	3
.2	6078161	shim ring 8x14x1,0 DIN988 A2 (10pc)	3
.3	6078162	o-ring ID.40,0x3,0 Viton (3pc)	1
.4	6067407	Barlian bow terminal M5 A2	1
.5	6007918	protecting hose 28,5/22,8 PA6	
.6	6017168	screw cap D.29 54.13974 1.4401	1
.7	6078163	o-ring ID.20,0x3,0 Viton 75 (3pc)	1
1	6000688	cable trumpet 42T 5m H07 7G1,5 KIT	1
1	6000689	CABLE TRUMPET 42T 10M H07 7G1,5 KIT	1
1	6000690	cable trumpet 42T 15m H07 7G1,5 KIT	1
1	6000691	cable trumpet 42T 20m H07 7G1,5 SET	1
1	6024687	cable trumpet 42T 25m H07 7G1,5 KIT	1
1	6032527	cable trumpet 42T 30m H07 7G1,5 KIT	1
1	6066420	cable trumpet 42T 35m H07 7G1,5 KIT	1
1	6000692	cable trumpet 42T 5m H07 10G1,5 KIT	1
1	6001115	cable trumpet 42T 10m H07 10G1,5 KIT	1
1	6000693	cable trumpet 42T 15m H07 10G1,5 KIT	1
1	6000694	cable trumpet 42T 20m H07 10G1,5 KIT	1
1	6046176	cable trumpet 42T 25m H07 10G1,5 KIT	1
2	6038293	cable trumpet 42T 10m S07RN-F 4G6(4x1)	1
3	6000699	cable trumpet 42T 5m NSS 2x1,5 KIT	1
3	6000700	cable trumpet 42T 10m NSS 2x1,5 KIT	1
3	6000701	cable trumpet 42T 15m NSS 2x1,5 KIT	1
3	6000702	cable trumpet 42T 20m NSS 2x1,5 KIT	1
3	6075910	cable trumpet 42T 25m NSS 2x1,5 KIT	1
3	6061578	cable trumpet 42T 30m NSS 2x1,5 KIT	1
3	6065996	cable trumpet 42T 45m NSS 2x1,5 KIT	1
3	6000703	cable trumpet 42T 5m NSS 4x1,5 KIT	1
3	6000704	cable trumpet 42T 10m NSS 4x1,5 KIT	1
3	6000705	Cable Trumpet 42T 15m NSS 4x1,5 KIT	1
3	6000706	cable trumpet 42T 20m NSS 4x1,5 KIT	1
3	6020376	cable trumpet 42T 25m NSS 4x1,5 KIT	1
3	6019867	cable trumpet 42T 30m NSS 4x1,5 KIT	1

cable trumpet 42T KIT

Item	Article no.	Description	Quantity
3	6036907	cable trumpet 42T 35m NSS 4x1,5 KIT	1
3	6038670	cable trumpet 42T 50m NSS 4x1,5 KIT	1
3	6040496	cable trumpet 42T 60m NSS 4x1,5 KIT	1
3	6000707	cable trumpet 42T 5m NSS 4x2,5 KIT	1
3	6000708	cable trumpet 42T 10m NSS 4x2,5 KIT	1
3	6000709	cable trumpet 42T 15m NSS 4x2,5 KIT	1
3	6001426	cable trumpet 42T 20m NSS 4x2,5 KIT	1
3	6066888	cable trumpet 42T 25m NSS 4x2,5 KIT	1
3	6001427	cable trumpet 42T 5m NSS 4x4 KIT	1
3	6001428	cable trumpet 42T 10m NSS 4x4 KIT	1
3	6001429	cable trumpet 42T 15m NSS 4x4 KIT	1
3	6001430	cable trumpet 42T 20m NSS 4x4 KIT	1
3	6075909	cable trumpet 42T 25m NSS 4x4 KIT	1
3	6067861	cable trumpet 42T 30m NSS 4x4 KIT	1
3	6072786	cable trumpet 42T 10m NSS 4x6 KIT	1
3	6066425	cable trumpet 42T 15m NSS 4x6 KIT	1
3	6068990	cable trumpet 42T 20m NSS 4x6 KIT	1
3	6065995	cable trumpet 42T 30m NSS 4x6 KIT	1
3	6065994	cable trumpet 42T 45m NSS 4x6 KIT	1
3	6040497	cable trumpet 42T 60m NSS 4x6 KIT	1
3	6044835	cable trumpet 42T 10m NSS 4x10 KIT	1
3	6067481	cable trumpet 42T 15m NSS 4x10 KIT	1
3	6070122	cable trumpet 42T 30m NSS 4x10 KIT	1
3	6001431	cable trumpet 42T 5m NSS 7x1,5 KIT	1
3	6001432	cable trumpet 42T 10m NSS 7x1,5 KIT	1
3	6001433	cable trumpet 42T 15m NSS 7x1,5 KIT	1
3	6001434	cable trumpet 42T 20m NSS 7x1,5 KIT	1
3	6040684	cable trumpet 42T 25m NSS 7x1,5 KIT	1
3	6074636	cable trumpet 42T 40m NSS 7x1,5 KIT	1
3	6001435	cable trumpet 42T 5m NSS 7x2,5 KIT	1
3	6001436	cable trumpet 42T 10M NSS 7x2,5 KIT	1
3	6001437	cable trumpet 42T 15m NSS 7x2,5 KIT	1
3	6001438	cable trumpet 42T 20m NSS 7x2,5 KIT	1
3	6036937	cable trumpet 42T 25m NSS 7x2,5 KIT	1

cable trumpet 42T KIT

Item	Article no.	Description	Quantity
3	6036906	cable trumpet 42T 35m NSS 7x2,5 KIT	1
3	6086145	cable trumpet 42T 10m NSS 10x1,5 SET	1
3	6068144	cable trumpet 42T 15m NSS 10x1,5 KIT	1
3	6078651	cable trumpet 42T 20m NSS 10x1,5 SET	1
3	6078807	cable trumpet 42T 25m NSS 10x1,5 SET	1
4	6046317	cable trumpet 42T 10m S07RC4N-F 4x1,5	1
4	6063563	cable trumpet 42T 40m S07RC4N-F 4x1,5	1
4	6066388	cable trumpet 42T 10m S07RC4N-F 7x1,5KIT	1
4	6061983	cable trumpet 42T 15m S07RC4N-F 4x1,5KIT	1
4	6046316	cable trumpet 42T 20m S07RC4N-F 4x4	1
5	6065152	cable trumpet 42T 10m 2* AWG14	1
5	6065153	cable trumpet 42T 20m 2* AWG14	1
5	6066488	cable trumpet 42T 20m 4* AWG14	1
5	6065151	cable trumpet 42T 10m 7* AWG14	1
5	6066489	cable trumpet 42T 20m 7* AWG14	1
5	6065150	cable trumpet 42T 10m 4* AWG10	1
6	2132620	on request	1

7	6067898	cable trumpet 42T 10m S07RC4N-F 12G1,5 C	1
8	6019360	cable trumpet 42T 5m H07 7G1,5 C KIT	1
8	6019362	cable trumpet 42T 15m H07 7G1,5 C KIT	1
9	6037455	cable trumpet 42T 10m NSS 4x1,5 C KIT	1
9	6019374	cable trumpet 42T 15m NSS 4x2,5 C KIT	1
9	6019381	cable trumpet 42T 10m NSS 7x1,5 C KIT	1
9	6019382	cable trumpet 42T 15m NSS 7x1,5 C KIT	1
9	6037454	cable trumpet 42T 10m NSS 7x2,5 C KIT	1
9	6019387	cable trumpet 42T 20m NSS 7x2,5 C KIT	1
9	6079792	cable trumpet 42T 30m NSS 7x2,5 C KIT	1
10	6019849	cable trumpet 42T RF 10m H07 7G1,5 KIT	1
10	6035148	cable trumpet 42T RF 15m H07 7G1,5 KIT	1
10	6038689	cable trumpet 42T RF 20m H07 7G1,5 KIT	1
11	6032612	cable trumpet 42T RF 10m NSS 7x1,5 KIT	1
11	6034277	cable trumpet 42T RF 30m NSS 7x1,5 KIT	1

cable trumpet 42T KIT

Item	Article no.	Description	Quantity
12	6044717	plug 42T KIT	1
13	6070010	cable trumpet 42T 15m NSSHC 3x16+3x2,5	1
14	6044834	cable trumpet 42T 10m NSS 4x16 KIT	1
14	6067480	cable trumpet 42T 15m NSS 4x16 KIT	1
14	6066168	cable trumpet 42T 20m NSS 4x16 KIT	1
14	6069678	cable trumpet 42T 25m NSS 4x16 KIT	1
14	6081974	cable trumpet 42T 40m NSS 4x16 KIT	1
15	6063562	cable trumpet 42T 40m S07RC4N-F 4x16	1
16	6067560	cable trumpet 42T 20m 4* AWG6	1

KS220H

Bm0

S/N < 650118681

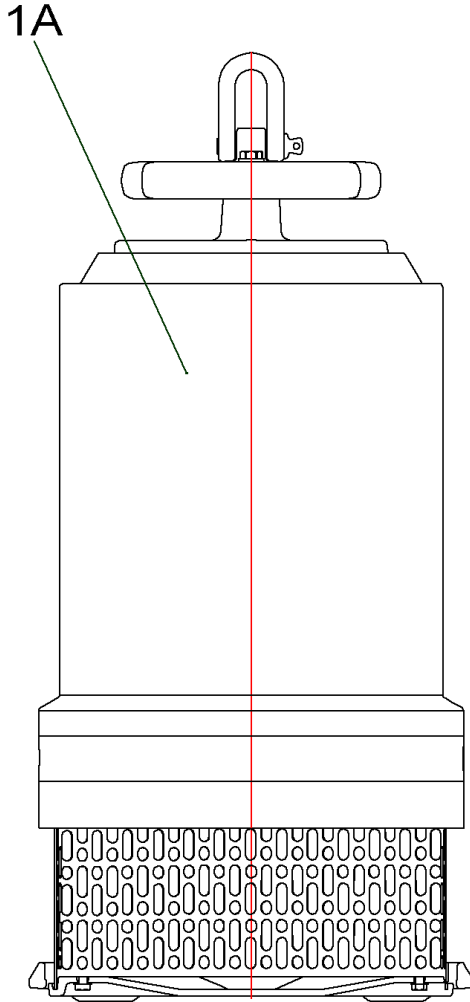

Bm1

S/N > 650118682

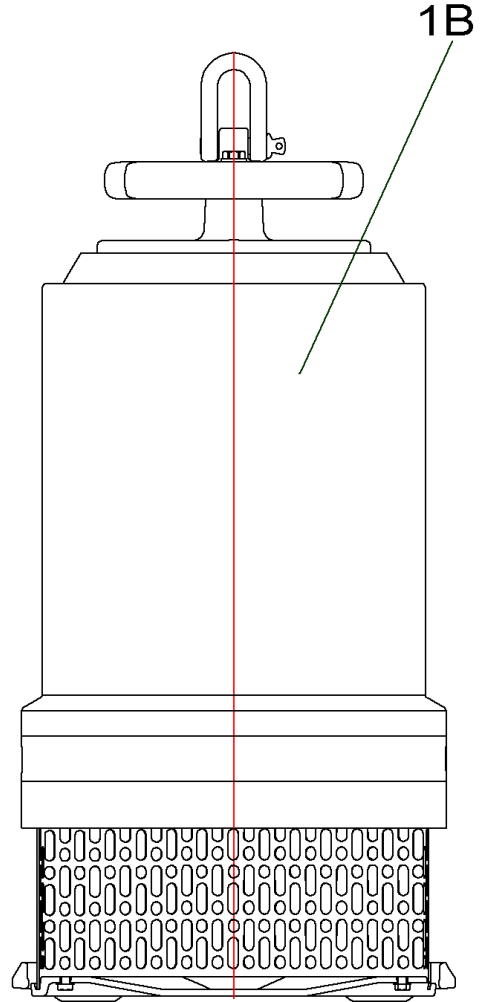

CONTRACTOR'S PUMP KS220H UNIT (6000091)

Item	Description	Quantity
1A	CONTRACTOR'S PUMP KS220H (Bm0)	1
1B	CONTRACTOR'S PUMP KS220H (Bm1)	1

CONTRACTOR'S PUMP KS220H (Bm0)

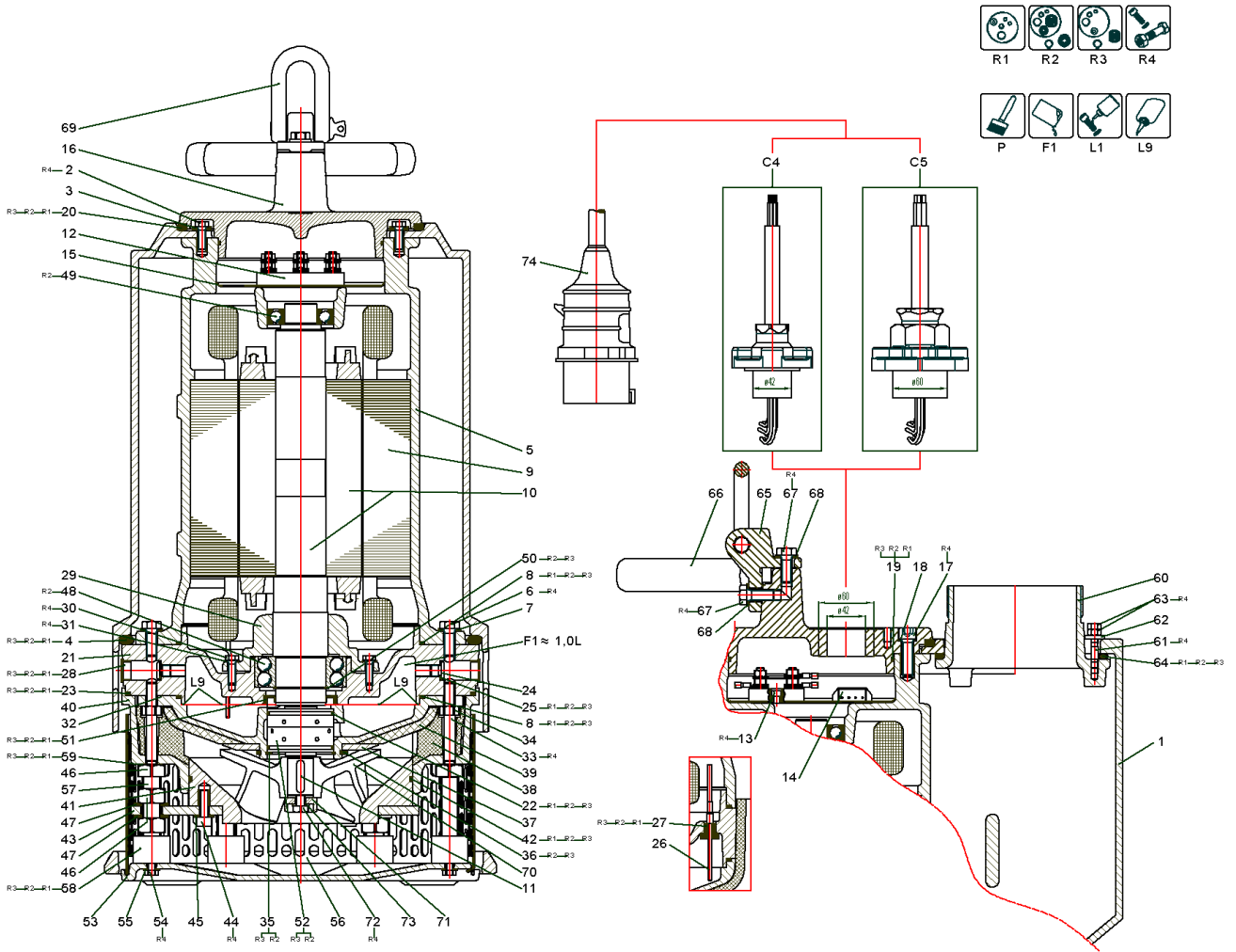

CONTRACTOR'S PUMP KS220H (Bm0)

Item	Article no.	Description	Quantity
R1	6016273	Rep.Kit 1 KS220 Vit	1
R2	6016288	Rep.Kit 2 KS220 Vit	1
R3	6016321	Rep.Kit 3 KS220 Vit	1
R4	6016127	Screws KS220 KIT	1
P	6042254	PAINT SPRAY Pantone334	1
P	6042255	colour 2K-paint IV80 pantone334C 250ml	1
P	6023614	Ceram C0 black 100 ml KIT	1
P	6020579	Ceram C0 black 250 ml KIT	1
P	6023485	Ceram C0 Black 500ml Kit	1
P	6019157	Ceram C0 black 1000 ml KIT	1
F1	6025460	medical white oil 1L KIT	1
F1	6025461	medical white oil 5L KIT	1
L1	6080531	Loctite 243 5g flask VP:	1
L1	2096167	Loctite 243 50ml VP.	1
L9	6080535	Loctite 5203 300ml VP.	1

C5		cable trumpet 60T KIT	1
C4		cable trumpet 42T KIT	2

1	6017268	pump shroud SG6 50.17861 Al/C0 alternativ / alternative / alternative	1
1	6032053	pump shroud SG6 50.17861 3.1371.61/C0	1
2		screw M8x25 DIN933 A4-70 (10pc)	1
3		washer 8,4 DIN7349 A4 (10pc)	1
4		o-ring ID.360,0x15,0 NBR55	1
5		motor casing 51.17863 Al	1
Note: auf Anfrage / on request / sur demande			
6		screw M12x30 DIN933 A4-70	6
7		washer A13 DIN125 A4 (20pc)	1
8		o-ring ID.255,0x4,0 Viton	1
9	6081415	Stator T24-2/21 400/690 50 PTC110° VP.	1
10	6010512	rotor D.133,5x537 2/21 1.4021 alternativ / alternative / alternative	1
10	6042221	rotor D.133,5x537 2/21 4021/4462 g	1

CONTRACTOR'S PUMP KS220H (Bm0)

Item	Article no.	Description	Quantity
11	6076643	key A 8x5x36 DIN6885 A4 VP.	1
12	6070362	terminal board 6pol. konf.	1
13		screw M6x16 DIN912 A4 (10pc)	1
14	6002712	connectors pin strip 4-polig	1
15	6010193	cover disc D.182 54.18083 MVL-UE 1x Ø 60mm gebohrt / drilled / percé	1
16	6010758	motor cover D.60 51.17865 GG/C0 2xØ 42mm gebohrt / drilled / percé	1
16	6010757	motor cover D.42 51.17865 GG/C0	1
17		screw M12x40 DIN912 A4-70 (10pc)	1
18		lock washer 12 DIN7980 A4	4
19		o-ring ID.170,0x3,0 NBR70	1
20		o-ring ID.250,0x8,0 NBR70	1
21	6010652	bearing housing 51.17867 GG/C0	1
8		o-ring ID.255,0x4,0 Viton	1
23		O-Ring ID.360,0x4,0 Viton 75 VP.	1
24	6002435	screw plug G1/4 A DIN908 A4	2
25	6007522	seal ring A14/18x1,5 DIN7603 PA	2
26	6017145	electrode rod D.4x77 54.13422 A2	2
27	6078171	sealing plug 13421 NBR 80 VP.	2
28	6007419	plug GPN300 F19 Plastik	2
29	6010648	bearing cover D.110H7 52.17868 Al	1
30		screw M8x25 DIN933 A4-70 (10pc)	1
31		washer A8,4 DIN125 1.4401 (20pc)	1
32	6010622	sealing flange D.355 51.17870 Al/C0	1
33		screw M12x85 DIN939 A2-70	6
34		nut M12 DIN934 A4-80 (10pcs)	1
35	6002185	circlips 72x2,5 DIN472 A2	1
36	6002053	circlips 90x3 DIN471 A2	1
37	6016948	washer D.90/170x7 54.18086 1.4301	1
38	6004316	guide casing 17871 PUR raw	1
39	6004703	wear plate 17873 PUR raw	1
40	6010927	pump housing A 51.17874 Al/C0	1
41	6010646	suction port D.244 52.17875 PA12G	1

CONTRACTOR'S PUMP KS220H (Bm0)

Item	Article no.	Description	Quantity
42		o-ring ID.230,0x4,0 NBR70	1
43	6016949	supporting plate 52.18084 1.4301	1
44		screw M10x30 ISO4762 A4-70	3
45		Washer A10,5 DIN125 A4 (20pcs)	1
46		nut M20 DIN934 A4-80 (10pc)	1
47		WASHER A21 DIN125 A4 (10pc)	1
48	6081300	ball bearing 5211 VP.	1
49	6081345	ball bearing 6207 w.2 Dichtschr. VP.	1
50	6081303	Circlip 55x2 DIN471 FSt VP.	1
51	6007473	shaft seal ring B55/80x10 Domsel NBR+A2	1
52	6074592	shaft sealing H35/2 VP.	1
		alternativ / alternative / alternative	
52	6075005	shaft sealing H35/2 1.4462 VP.	1
22	6080478	o-ring ID.65,0x3,0 Viton molyk.70 (2pc)	1
53	6017267	base plate D.392 51.17882 Al/C0	1
54		screw M8x16 DIN933 A4-70	6
55		washer A8,4 DIN125 1.4401 (20pc)	1
56	6004875	strainer 175x380x2 51.17883 1.4301	1
57	6010755	spacer M20x65 DIN933 54.17884 A4	6
58	6002685	rubber buffer Tiegler B/GM40 NB	6
59		Dubo-washer M12 NR.207 PA	6
60	6010756	discharge piece G6 52.17885 GGG/C0	1
61		screw M8x40 DIN939 A4	4
62		washer 8,4 DIN7349 A4 (10pc)	1
63		nut M8 DIN934 A4	8
64		O-RING ID.184X8N DIN3771 NBR70	1
65	6017259	handle 52.17887 1.4581	1
66	6003986	handle 52.17333 St-Gummi	1
67		screw M12x30 DIN933 A4-70	2
68		washer A13 DIN125 A4 (20pc)	1
69	6003030	shackle 16mm 1.4401	1
		Laufrad / Impeller / Roue 50Hz	
70	6033182	impeller-H/MH D.230 52.17966 Abrasit	1
		Laufrad / Impeller / Roue 60Hz	

CONTRACTOR'S PUMP KS220H (Bm0)

Item	Article no.	Description	Quantity
70	6033183	impeller-H/MH D.208 52.17966 Abrasit	1
71	6011711	washer D.35/11x16 55.1865 1.4021	1
		alternativ / alternative / alternative	
71	6011710	washer D.35/11x16 55.1865 1.4462	1
72	6003623	screw M10x30 DIN933 10.9 Geomet	1
73	2043863	SCREW LOCKING NORD-LOCK 16/10,7 A4	1
74	6003012	plug CEE63A/400V/5P-6H/IP67	1

cablE trumpet 60T KIT

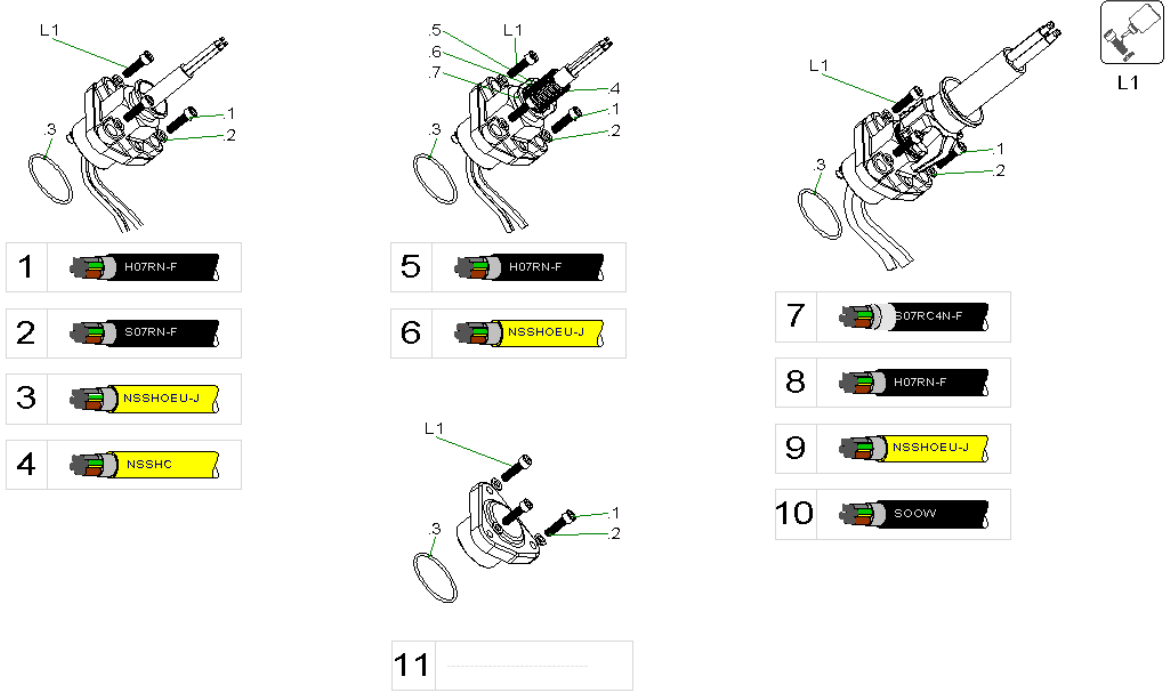

cable trumpet 60T KIT

Item	Article no.	Description	Quantity
L1	6080531	Loctite 243 5g flask VP:	1
.1	6078159	screw M8x30 DIN912 A4-70 (10pc)	3
.2	6078161	shim ring 8x14x1,0 DIN988 A2 (10pc)	3
.3	6007747	o-ring ID.60,0x3,0 NBR70	1
.4	6062009	protecting cover 42,5/35,5 PA6	
.5	6017168	screw cap D.29 54.13974 1.4401	1
.6	6078163	o-ring ID.20,0x3,0 Viton 75 (3pc)	1
.7	6017170	screwed hose connection Pg29 55.13614 1.	1
1	6001513	cable trumpet 60T 20m H07 4x1,5 KIT	1
1	6001535	cable trumpet 60T 10m H07 10x1,5 KIT	1
2	6035224	cable trumpet 60T 20m S07RN-F 4G6(4x1)	1
2	6045369	cable trumpet 60T 50m S07RN-F 4G6(4x1)	1
3	6001346	cable trumpet 60T 5m NSS 4x1,5 KIT	1
3	6001347	cable trumpet 60T 10m NSS 4x1,5 KIT	1
3	6001348	cable trumpet 60T 15m NSS 4x1,5 KIT	1
3	6001349	cable trumpet 60T 20m NSS 4x1,5 KIT	1
3	6001354	cable trumpet 60T 5m NSS 4x2,5 KIT	1
3	6001355	cable trumpet 60T 10m NSS 4x2,5 KIT	1
3	6001356	cable trumpet 60T 15m NSS 4x2,5 KIT	1
3	6001357	cable trumpet 60T 20m NSS 4x2,5 KIT	1
3	6001358	cable trumpet 60T 5m NSS 4x4 KIT	1
3	6001359	cable trumpet 60T 10m NSS 4x4 KIT	1
3	6001360	Cable Trumpet 60T 15m NSS 4x4 KIT	1
3	6001361	cable trumpet 60T 20m NSS 4x4 KIT	1
3	6042246	cable trumpet 60T 25m NSS 4x4 KIT	1
3	6001482	cable trumpet 60T 5m NSS 4x6 KIT	1
3	6001483	Leitungsdurchf. 60T 10m NSS 4x6 SET	1
3	6001484	cable trumpet 60T 15M NSS 4x6 KIT	1
3	6001485	cable trumpet 60T 20m NSS 4x6 KIT	1
3	6001486	cable trumpet 60T 5m NSS 4x10 KIT	1
3	6001487	cable trumpet 60T 10M NSS 4x10 KIT	1
3	6001488	cable trumpet 60T 15m NSS 4x10 KIT	1
3	6001489	cable trumpet 60T 20m NSS 4x10 KIT	1
3	6001364	cable trumpet 60T 5m NSS 7x1,5 KIT	1

cable trumpet 60T KIT

Item	Article no.	Description	Quantity
3	6001365	cable trumpet 60T 10m NSS 7x1,5 KIT	1
3	6001366	cable trumpet 60T 15m NSS 7x1,5 KIT	1
3	6001367	cable trumpet 60T 20m NSS 7x1,5 KIT	1
3	6001335	cable trumpet 60T 5m NSS 7x2,5 KIT	1
3	6001334	cable trumpet 60T 10m NSS 7x2,5 KIT	1
3	6001336	cable trumpet 60T 15m NSS 7x2,5 KIT	1
3	6001337	cable trumpet 60T 20m NSS 7x2,5 KIT	1
3	6020377	cable trumpet 60T 25m NSS 7x2,5 KIT	1
3	6038669	cable trumpet 60T 50m NSS 7x2,5 KIT	1
3	6001368	cable trumpet 60T 5m NSS 10x1,5 KIT	1
3	6001369	cable trumpet 60T 10m NSS 10x1,5 KIT	1
3	6001480	cable trumpet 60T 15m NSS 10x1,5 KIT	1
3	6001481	cable trumpet 60T 20m NSS 10x1,5 KIT	1
4	6070013	cable trumpet 60T 15m NSSHC 3x16+3x2,5	1
6	6067482	cable trumpet 60T 10m NSS 4x10 C KIT	1
6	6039693	cable trumpet 60T 10m NSS 7x2,5 C KIT	1
7	6081596	cable trumpet 60T 10m S07RC4N-F 4G4	1
7	6085233	cable trumpet 60T 15m S07RC4N-F 4G4	1
7	6026674	cable trumpet 60T 20m S07RC4N-F 4G4	1
7	6066387	cable trumpet 60T 10m S07RC4N8-F 4G16	1
7	6061984	cable trumpet 60T 15m S07RC4N8-F 4G16	1
7	6063564	cable trumpet 60T 40m S07RC4N8-F 4G16	1
7	6085234	cable trumpet 60T 15m S07RC4N8-F 4G25	1
9	6001490	cable trumpet 60T 5m NSS 4x16 KIT	1
9	6001491	cable trumpet 60T 10m NSS 4x16 KIT	1
9	6001492	cable trumpet 60T 15m NSS 4x16 KIT	1
9	6001493	cable trumpet 60T 20m NSS 4x16 KIT	1
9	6021510	cable trumpet 60T 30m NSS 4x16 KIT	1
9	6042287	cable trumpet 60T 60m NSS 4x16 KIT	1
9	6001494	cable trumpet 60T 5m NSS 4x25 KIT	1
9	6001495	cable trumpet 60T 10m NSS 4x25 KIT	1
9	6001496	cable trumpet 60T 15m NSS 4x25 KIT	1
9	6001497	cable trumpet 60T 20m NSS 4x25 KIT	1
9	6034270	cable trumpet 60T 30m NSS 4x25 KIT	1

cable trumpet 60T KIT

Item	Article no.	Description	Quantity
9	6070758	cable trumpet 60T 40m NSS 4x25 KIT	1
10	6065154	cable trumpet 60T 10m 4* AWG4	1
10	6065155	cable trumpet 60T 20m 4* AWG4	1
11	6044718	plug 60T KIT	1

cablE trumpet 42T KIT

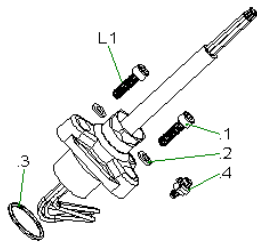

- 1 H07RN-F
- 2 S07RN-F
- 3 NSSHOEU-J
- 4 S07RC4N-F
- 5 SOOW
- 6 NSSHC0U-J

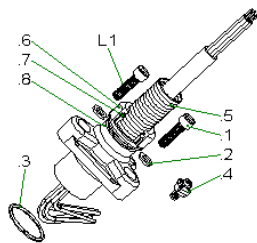

- 7 S07RC4N-F
- 8 H07RN-F
- 9 NSSHOEU-J
- 10 H07RN-F
- 11 NSSHOEU-J

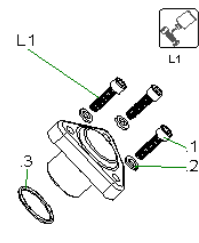

- 12 -----
- 13 NSSHC0U-J
- 14 NSSHOEU-J
- 15 S07RC4N-F
- 16 SOOW

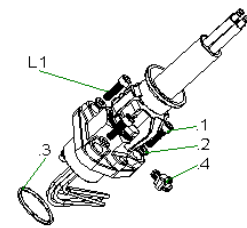

cable trumpet 42T KIT

Item	Article no.	Description	Quantity
L1	6080531	Loctite 243 5g flask VP:	1
.1	6078159	screw M8x30 DIN912 A4-70 (10pc)	3
.2	6078161	shim ring 8x14x1,0 DIN988 A2 (10pc)	3
.3	6078162	o-ring ID.40,0x3,0 Viton (3pc)	1
.4	6067407	Barlian bow terminal M5 A2	1
.5	6007918	protecting hose 28,5/22,8 PA6	
.6	6017168	screw cap D.29 54.13974 1.4401	1
.7	6078163	o-ring ID.20,0x3,0 Viton 75 (3pc)	1
1	6000688	cable trumpet 42T 5m H07 7G1,5 KIT	1
1	6000689	CABLE TRUMPET 42T 10M H07 7G1,5 KIT	1
1	6000690	cable trumpet 42T 15m H07 7G1,5 KIT	1
1	6000691	cable trumpet 42T 20m H07 7G1,5 SET	1
1	6024687	cable trumpet 42T 25m H07 7G1,5 KIT	1
1	6032527	cable trumpet 42T 30m H07 7G1,5 KIT	1
1	6066420	cable trumpet 42T 35m H07 7G1,5 KIT	1
1	6000692	cable trumpet 42T 5m H07 10G1,5 KIT	1
1	6001115	cable trumpet 42T 10m H07 10G1,5 KIT	1
1	6000693	cable trumpet 42T 15m H07 10G1,5 KIT	1
1	6000694	cable trumpet 42T 20m H07 10G1,5 KIT	1
1	6046176	cable trumpet 42T 25m H07 10G1,5 KIT	1
2	6038293	cable trumpet 42T 10m S07RN-F 4G6(4x1)	1
3	6000699	cable trumpet 42T 5m NSS 2x1,5 KIT	1
3	6000700	cable trumpet 42T 10m NSS 2x1,5 KIT	1
3	6000701	cable trumpet 42T 15m NSS 2x1,5 KIT	1
3	6000702	cable trumpet 42T 20m NSS 2x1,5 KIT	1
3	6075910	cable trumpet 42T 25m NSS 2x1,5 KIT	1
3	6061578	cable trumpet 42T 30m NSS 2x1,5 KIT	1
3	6065996	cable trumpet 42T 45m NSS 2x1,5 KIT	1
3	6000703	cable trumpet 42T 5m NSS 4x1,5 KIT	1
3	6000704	cable trumpet 42T 10m NSS 4x1,5 KIT	1
3	6000705	Cable Trumpet 42T 15m NSS 4x1,5 KIT	1
3	6000706	cable trumpet 42T 20m NSS 4x1,5 KIT	1
3	6020376	cable trumpet 42T 25m NSS 4x1,5 KIT	1
3	6019867	cable trumpet 42T 30m NSS 4x1,5 KIT	1

cable trumpet 42T KIT

Item	Article no.	Description	Quantity
3	6036907	cable trumpet 42T 35m NSS 4x1,5 KIT	1
3	6038670	cable trumpet 42T 50m NSS 4x1,5 KIT	1
3	6040496	cable trumpet 42T 60m NSS 4x1,5 KIT	1
3	6000707	cable trumpet 42T 5m NSS 4x2,5 KIT	1
3	6000708	cable trumpet 42T 10m NSS 4x2,5 KIT	1
3	6000709	cable trumpet 42T 15m NSS 4x2,5 KIT	1
3	6001426	cable trumpet 42T 20m NSS 4x2,5 KIT	1
3	6066888	cable trumpet 42T 25m NSS 4x2,5 KIT	1
3	6001427	cable trumpet 42T 5m NSS 4x4 KIT	1
3	6001428	cable trumpet 42T 10m NSS 4x4 KIT	1
3	6001429	cable trumpet 42T 15m NSS 4x4 KIT	1
3	6001430	cable trumpet 42T 20m NSS 4x4 KIT	1
3	6075909	cable trumpet 42T 25m NSS 4x4 KIT	1
3	6067861	cable trumpet 42T 30m NSS 4x4 KIT	1
3	6072786	cable trumpet 42T 10m NSS 4x6 KIT	1
3	6066425	cable trumpet 42T 15m NSS 4x6 KIT	1
3	6068990	cable trumpet 42T 20m NSS 4x6 KIT	1
3	6065995	cable trumpet 42T 30m NSS 4x6 KIT	1
3	6065994	cable trumpet 42T 45m NSS 4x6 KIT	1
3	6040497	cable trumpet 42T 60m NSS 4x6 KIT	1
3	6044835	cable trumpet 42T 10m NSS 4x10 KIT	1
3	6067481	cable trumpet 42T 15m NSS 4x10 KIT	1
3	6070122	cable trumpet 42T 30m NSS 4x10 KIT	1
3	6001431	cable trumpet 42T 5m NSS 7x1,5 KIT	1
3	6001432	cable trumpet 42T 10m NSS 7x1,5 KIT	1
3	6001433	cable trumpet 42T 15m NSS 7x1,5 KIT	1
3	6001434	cable trumpet 42T 20m NSS 7x1,5 KIT	1
3	6040684	cable trumpet 42T 25m NSS 7x1,5 KIT	1
3	6074636	cable trumpet 42T 40m NSS 7x1,5 KIT	1
3	6001435	cable trumpet 42T 5m NSS 7x2,5 KIT	1
3	6001436	cable trumpet 42T 10M NSS 7x2,5 KIT	1
3	6001437	cable trumpet 42T 15m NSS 7x2,5 KIT	1
3	6001438	cable trumpet 42T 20m NSS 7x2,5 KIT	1
3	6036937	cable trumpet 42T 25m NSS 7x2,5 KIT	1

cable trumpet 42T KIT

Item	Article no.	Description	Quantity
3	6036906	cable trumpet 42T 35m NSS 7x2,5 KIT	1
3	6086145	cable trumpet 42T 10m NSS 10x1,5 SET	1
3	6068144	cable trumpet 42T 15m NSS 10x1,5 KIT	1
3	6078651	cable trumpet 42T 20m NSS 10x1,5 SET	1
3	6078807	cable trumpet 42T 25m NSS 10x1,5 SET	1
4	6046317	cable trumpet 42T 10m S07RC4N-F 4x1,5	1
4	6063563	cable trumpet 42T 40m S07RC4N-F 4x1,5	1
4	6066388	cable trumpet 42T 10m S07RC4N-F 7x1,5KIT	1
4	6061983	cable trumpet 42T 15m S07RC4N-F 4x1,5KIT	1
4	6046316	cable trumpet 42T 20m S07RC4N-F 4x4	1
5	6065152	cable trumpet 42T 10m 2* AWG14	1
5	6065153	cable trumpet 42T 20m 2* AWG14	1
5	6066488	cable trumpet 42T 20m 4* AWG14	1
5	6065151	cable trumpet 42T 10m 7* AWG14	1
5	6066489	cable trumpet 42T 20m 7* AWG14	1
5	6065150	cable trumpet 42T 10m 4* AWG10	1
6	2132620	on request	1

7	6067898	cable trumpet 42T 10m S07RC4N-F 12G1,5 C	1
8	6019360	cable trumpet 42T 5m H07 7G1,5 C KIT	1
8	6019362	cable trumpet 42T 15m H07 7G1,5 C KIT	1
9	6037455	cable trumpet 42T 10m NSS 4x1,5 C KIT	1
9	6019374	cable trumpet 42T 15m NSS 4x2,5 C KIT	1
9	6019381	cable trumpet 42T 10m NSS 7x1,5 C KIT	1
9	6019382	cable trumpet 42T 15m NSS 7x1,5 C KIT	1
9	6037454	cable trumpet 42T 10m NSS 7x2,5 C KIT	1
9	6019387	cable trumpet 42T 20m NSS 7x2,5 C KIT	1
9	6079792	cable trumpet 42T 30m NSS 7x2,5 C KIT	1
10	6019849	cable trumpet 42T RF 10m H07 7G1,5 KIT	1
10	6035148	cable trumpet 42T RF 15m H07 7G1,5 KIT	1
10	6038689	cable trumpet 42T RF 20m H07 7G1,5 KIT	1
11	6032612	cable trumpet 42T RF 10m NSS 7x1,5 KIT	1
11	6034277	cable trumpet 42T RF 30m NSS 7x1,5 KIT	1

cable trumpet 42T KIT

Item	Article no.	Description	Quantity
12	6044717	plug 42T KIT	1
13	6070010	cable trumpet 42T 15m NSSHC 3x16+3x2,5	1
14	6044834	cable trumpet 42T 10m NSS 4x16 KIT	1
14	6067480	cable trumpet 42T 15m NSS 4x16 KIT	1
14	6066168	cable trumpet 42T 20m NSS 4x16 KIT	1
14	6069678	cable trumpet 42T 25m NSS 4x16 KIT	1
14	6081974	cable trumpet 42T 40m NSS 4x16 KIT	1
15	6063562	cable trumpet 42T 40m S07RC4N-F 4x16	1
16	6067560	cable trumpet 42T 20m 4* AWG6	1

CONTRACTOR'S PUMP KS220H (Bm1)

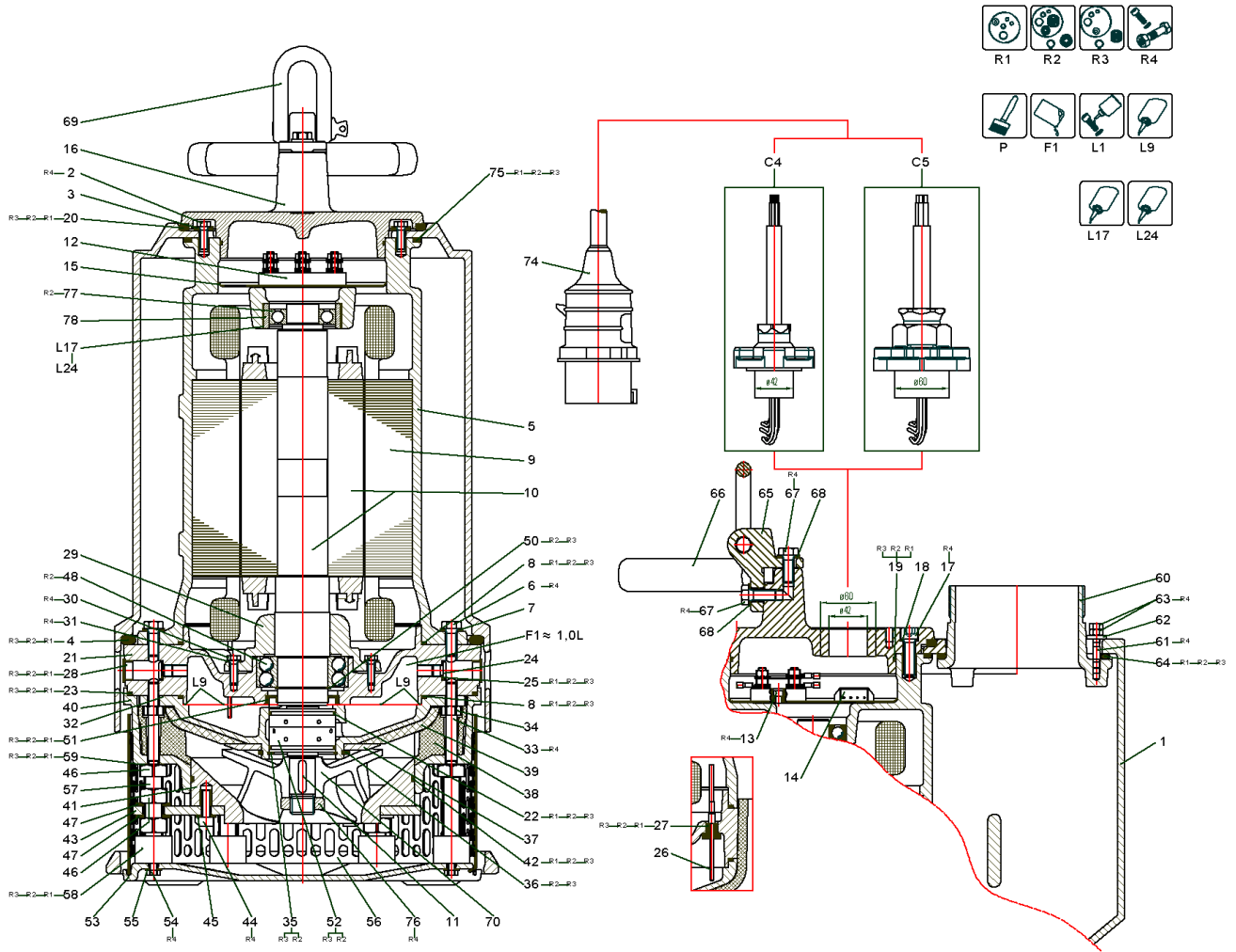

CONTRACTOR'S PUMP KS220H (Bm1)

Item	Article no.	Description	Quantity
R1	6016273	Rep.Kit 1 KS220 Vit	1
R2	6016288	Rep.Kit 2 KS220 Vit	1
R3	6016321	Rep.Kit 3 KS220 Vit	1
R4	6016127	Screws KS220 KIT	1
P	6042254	PAINT SPRAY Pantone334	1
P	6042255	colour 2K-paint IV80 pantone334C 250ml	1
P	6023614	Ceram C0 black 100 ml KIT	1
P	6020579	Ceram C0 black 250 ml KIT	1
P	6023485	Ceram C0 Black 500ml Kit	1
P	6019157	Ceram C0 black 1000 ml KIT	1
F1	6025460	medical white oil 1L KIT	1
F1	6025461	medical white oil 5L KIT	1
L1	6080531	Loctite 243 5g flask VP:	1
L1	2096167	Loctite 243 50ml VP.	1
L9	6080535	Loctite 5203 300ml VP.	1
L17		Loctite 7649 500ml	1
L24	6063947	Loctite 3504 50ml	1

C5		cable trumpet 60T KIT	1
C4		cable trumpet 42T KIT	2

1	6017268	pump shroud SG6 50.17861 Al/C0 alternativ / alternative / alternative	1
1	6032053	pump shroud SG6 50.17861 3.1371.61/C0	1
2		screw M8x25 DIN933 A4-70 (10pc)	1
3		washer 8,4 DIN7349 A4 (10pc)	1
4		o-ring ID.360,0x15,0 NBR55	1
5		motor casing 51.17863/1 Al	1
Note: auf Anfrage / on request / sur demande			
78		bush D.85/71x27 6050391 1.4462	1
Note: auf Anfrage / on request / sur demande			
75	6063517	o-ring ID.242,0x6,0 Viton	1
6		screw M12x30 DIN933 A4-70	6
7		washer A13 DIN125 A4 (20pc)	1

CONTRACTOR'S PUMP KS220H (Bm1)

Item	Article no.	Description	Quantity
8		o-ring ID.255,0x4,0 Viton	1
9	6081415	Stator T24-2/21 400/690 50 PTC110° VP.	1
10	6045397	rotor D.133,5x557 2/21 4021/4462 g	1
		alternativ / alternative / alternative	
10	6045395	rotor D.133,5x557 2/21 4021/4462 g	1
76	6038971	nut M27x2,0 DIN439 A2	1
11	6076643	key A 8x5x36 DIN6885 A4 VP.	1
12	6070362	terminal board 6pol. konf.	1
13		screw M6x16 DIN912 A4 (10pc)	1
14	6002712	connectors pin strip 4-polig	1
15	6010193	cover disc D.182 54.18083 MVL-UE	1
		1x Ø 60mm gebohrt / drilled / percè	
16	6010758	motor cover D.60 51.17865 GG/C0	1
		2xØ 42mm gebohrt / drilled / percè	
16	6010757	motor cover D.42 51.17865 GG/C0	1
17		screw M12x40 DIN912 A4-70 (10pc)	1
18		lock washer 12 DIN7980 A4	4
19		o-ring ID.170,0x3,0 NBR70	1
20		o-ring ID.250,0x8,0 NBR70	1
21	6010652	bearing housing 51.17867 GG/C0	1
8		o-ring ID.255,0x4,0 Viton	1
23		O-Ring ID.360,0x4,0 Viton 75 VP.	1
24	6002435	screw plug G1/4 A DIN908 A4	2
25	6007522	seal ring A14/18x1,5 DIN7603 PA	2
26	6017145	electrode rod D.4x77 54.13422 A2	2
27	6078171	sealing plug 13421 NBR 80 VP.	2
28	6007419	plug GPN300 F19 Plastik	2
29	6010648	bearing cover D.110H7 52.17868 Al	1
30		screw M8x25 DIN933 A4-70 (10pc)	1
31		washer A8,4 DIN125 1.4401 (20pc)	1
32	6010622	sealing flange D.355 51.17870 Al/C0	1
33		screw M12x85 DIN939 A2-70	6
34		nut M12 DIN934 A4-80 (10pcs)	1
35	6002185	circlips 72x2,5 DIN472 A2	1

CONTRACTOR'S PUMP KS220H (Bm1)

Item	Article no.	Description	Quantity
36	6002053	circlips 90x3 DIN471 A2	1
37	6016948	washer D.90/170x7 54.18086 1.4301	1
38	6004316	guide casing 17871 PUR raw	1
39	6004703	wear plate 17873 PUR raw	1
40	6010927	pump housing A 51.17874 Al/C0	1
41	6010646	suction port D.244 52.17875 PA12G	1
42		o-ring ID.230,0x4,0 NBR70	1
43	6016949	supporting plate 52.18084 1.4301	1
44		screw M10x30 ISO4762 A4-70	3
45		Washer A10,5 DIN125 A4 (20pcs)	1
46		nut M20 DIN934 A4-80 (10pc)	1
47		WASHER A21 DIN125 A4 (10pc)	1
48	6081300	ball bearing 5211 VP.	1
77	6081345	ball bearing 6207 w.2 Dichts. VP.	1
50	6081303	Circlip 55x2 DIN471 FSt VP.	1
51	6007473	shaft seal ring B55/80x10 Domsel NBR+A2	1
52	6074592	shaft sealing H35/2 VP.	1
		alternativ / alternative / alternative	
52	6075005	shaft sealing H35/2 1.4462 VP.	1
22	6080478	o-ring ID.65,0x3,0 Viton molyk.70 (2pc)	1
53	6017267	base plate D.392 51.17882 Al/C0	1
54		screw M8x16 DIN933 A4-70	6
55		washer A8,4 DIN125 1.4401 (20pc)	1
56	6004875	strainer 175x380x2 51.17883 1.4301	1
57	6010755	spacer M20x65 DIN933 54.17884 A4	6
58	6002685	rubber buffer Tiegler B/GM40 NB	6
59		Dubo-washer M12 NR.207 PA	6
60	6010756	discharge piece G6 52.17885 GGG/C0	1
61		screw M8x40 DIN939 A4	4
62		washer 8,4 DIN7349 A4 (10pc)	1
63		nut M8 DIN934 A4	8
64		O-RING ID.184X8N DIN3771 NBR70	1
65	6017259	handle 52.17887 1.4581	1
66	6003986	handle 52.17333 St-Gummi	1

CONTRACTOR'S PUMP KS220H (Bm1)

Item	Article no.	Description	Quantity
67		screw M12x30 DIN933 A4-70	2
68		washer A13 DIN125 A4 (20pc)	1
69	6003030	shackle 16mm 1.4401	1
		Laufrad / Impeller / Roue 50Hz	
70	6033182	impeller-H/MH D.230 52.17966 Abrasit	1
		Laufrad / Impeller / Roue 60Hz	
70	6033183	impeller-H/MH D.208 52.17966 Abrasit	1
74	6003012	plug CEE63A/400V/5P-6H/IP67	1

cablE trumpet 60T KIT

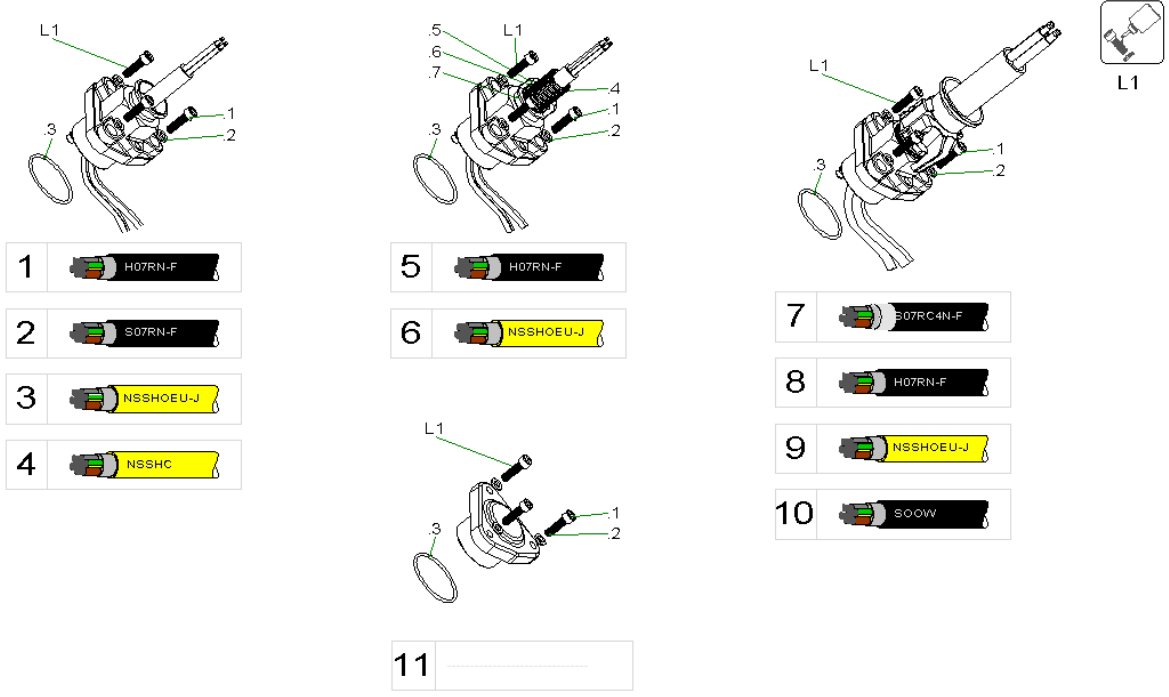

cable trumpet 60T KIT

Item	Article no.	Description	Quantity
L1	6080531	Loctite 243 5g flask VP:	1
.1	6078159	screw M8x30 DIN912 A4-70 (10pc)	3
.2	6078161	shim ring 8x14x1,0 DIN988 A2 (10pc)	3
.3	6007747	o-ring ID.60,0x3,0 NBR70	1
.4	6062009	protecting cover 42,5/35,5 PA6	
.5	6017168	screw cap D.29 54.13974 1.4401	1
.6	6078163	o-ring ID.20,0x3,0 Viton 75 (3pc)	1
.7	6017170	screwed hose connection Pg29 55.13614 1.	1
1	6001513	cable trumpet 60T 20m H07 4x1,5 KIT	1
1	6001535	cable trumpet 60T 10m H07 10x1,5 KIT	1
2	6035224	cable trumpet 60T 20m S07RN-F 4G6(4x1)	1
2	6045369	cable trumpet 60T 50m S07RN-F 4G6(4x1)	1
3	6001346	cable trumpet 60T 5m NSS 4x1,5 KIT	1
3	6001347	cable trumpet 60T 10m NSS 4x1,5 KIT	1
3	6001348	cable trumpet 60T 15m NSS 4x1,5 KIT	1
3	6001349	cable trumpet 60T 20m NSS 4x1,5 KIT	1
3	6001354	cable trumpet 60T 5m NSS 4x2,5 KIT	1
3	6001355	cable trumpet 60T 10m NSS 4x2,5 KIT	1
3	6001356	cable trumpet 60T 15m NSS 4x2,5 KIT	1
3	6001357	cable trumpet 60T 20m NSS 4x2,5 KIT	1
3	6001358	cable trumpet 60T 5m NSS 4x4 KIT	1
3	6001359	cable trumpet 60T 10m NSS 4x4 KIT	1
3	6001360	Cable Trumpet 60T 15m NSS 4x4 KIT	1
3	6001361	cable trumpet 60T 20m NSS 4x4 KIT	1
3	6042246	cable trumpet 60T 25m NSS 4x4 KIT	1
3	6001482	cable trumpet 60T 5m NSS 4x6 KIT	1
3	6001483	Leitungsdurchf. 60T 10m NSS 4x6 SET	1
3	6001484	cable trumpet 60T 15M NSS 4x6 KIT	1
3	6001485	cable trumpet 60T 20m NSS 4x6 KIT	1
3	6001486	cable trumpet 60T 5m NSS 4x10 KIT	1
3	6001487	cable trumpet 60T 10M NSS 4x10 KIT	1
3	6001488	cable trumpet 60T 15m NSS 4x10 KIT	1
3	6001489	cable trumpet 60T 20m NSS 4x10 KIT	1
3	6001364	cable trumpet 60T 5m NSS 7x1,5 KIT	1

cable trumpet 60T KIT

Item	Article no.	Description	Quantity
3	6001365	cable trumpet 60T 10m NSS 7x1,5 KIT	1
3	6001366	cable trumpet 60T 15m NSS 7x1,5 KIT	1
3	6001367	cable trumpet 60T 20m NSS 7x1,5 KIT	1
3	6001335	cable trumpet 60T 5m NSS 7x2,5 KIT	1
3	6001334	cable trumpet 60T 10m NSS 7x2,5 KIT	1
3	6001336	cable trumpet 60T 15m NSS 7x2,5 KIT	1
3	6001337	cable trumpet 60T 20m NSS 7x2,5 KIT	1
3	6020377	cable trumpet 60T 25m NSS 7x2,5 KIT	1
3	6038669	cable trumpet 60T 50m NSS 7x2,5 KIT	1
3	6001368	cable trumpet 60T 5m NSS 10x1,5 KIT	1
3	6001369	cable trumpet 60T 10m NSS 10x1,5 KIT	1
3	6001480	cable trumpet 60T 15m NSS 10x1,5 KIT	1
3	6001481	cable trumpet 60T 20m NSS 10x1,5 KIT	1
4	6070013	cable trumpet 60T 15m NSSHC 3x16+3x2,5	1
6	6067482	cable trumpet 60T 10m NSS 4x10 C KIT	1
6	6039693	cable trumpet 60T 10m NSS 7x2,5 C KIT	1
7	6081596	cable trumpet 60T 10m S07RC4N-F 4G4	1
7	6085233	cable trumpet 60T 15m S07RC4N-F 4G4	1
7	6026674	cable trumpet 60T 20m S07RC4N-F 4G4	1
7	6066387	cable trumpet 60T 10m S07RC4N8-F 4G16	1
7	6061984	cable trumpet 60T 15m S07RC4N8-F 4G16	1
7	6063564	cable trumpet 60T 40m S07RC4N8-F 4G16	1
7	6085234	cable trumpet 60T 15m S07RC4N8-F 4G25	1
9	6001490	cable trumpet 60T 5m NSS 4x16 KIT	1
9	6001491	cable trumpet 60T 10m NSS 4x16 KIT	1
9	6001492	cable trumpet 60T 15m NSS 4x16 KIT	1
9	6001493	cable trumpet 60T 20m NSS 4x16 KIT	1
9	6021510	cable trumpet 60T 30m NSS 4x16 KIT	1
9	6042287	cable trumpet 60T 60m NSS 4x16 KIT	1
9	6001494	cable trumpet 60T 5m NSS 4x25 KIT	1
9	6001495	cable trumpet 60T 10m NSS 4x25 KIT	1
9	6001496	cable trumpet 60T 15m NSS 4x25 KIT	1
9	6001497	cable trumpet 60T 20m NSS 4x25 KIT	1
9	6034270	cable trumpet 60T 30m NSS 4x25 KIT	1

cable trumpet 60T KIT

Item	Article no.	Description	Quantity
9	6070758	cable trumpet 60T 40m NSS 4x25 KIT	1
10	6065154	cable trumpet 60T 10m 4* AWG4	1
10	6065155	cable trumpet 60T 20m 4* AWG4	1
11	6044718	plug 60T KIT	1

cablE trumpet 42T KIT

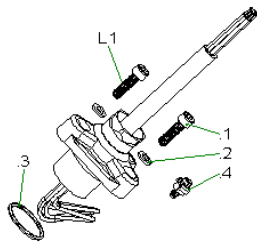

- 1 H07RN-F
- 2 S07RN-F
- 3 NSSHOEU-J
- 4 S07RC4N-F
- 5 SOOW
- 6 NSSHC0U-J

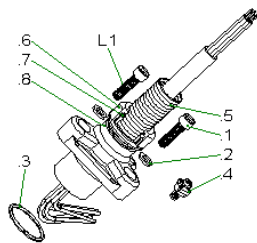

- 7 S07RC4N-F
- 8 H07RN-F
- 9 NSSHOEU-J
- 10 H07RN-F
- 11 NSSHOEU-J

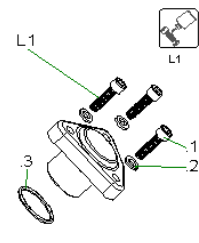

- 12 -----
- 13 NSSHC0U-J
- 14 NSSHOEU-J
- 15 S07RC4N-F
- 16 SOOW

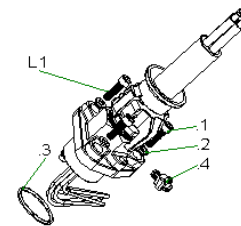

cable trumpet 42T KIT

Item	Article no.	Description	Quantity
L1	6080531	Loctite 243 5g flask VP:	1
.1	6078159	screw M8x30 DIN912 A4-70 (10pc)	3
.2	6078161	shim ring 8x14x1,0 DIN988 A2 (10pc)	3
.3	6078162	o-ring ID.40,0x3,0 Viton (3pc)	1
.4	6067407	Barlian bow terminal M5 A2	1
.5	6007918	protecting hose 28,5/22,8 PA6	
.6	6017168	screw cap D.29 54.13974 1.4401	1
.7	6078163	o-ring ID.20,0x3,0 Viton 75 (3pc)	1
1	6000688	cable trumpet 42T 5m H07 7G1,5 KIT	1
1	6000689	CABLE TRUMPET 42T 10M H07 7G1,5 KIT	1
1	6000690	cable trumpet 42T 15m H07 7G1,5 KIT	1
1	6000691	cable trumpet 42T 20m H07 7G1,5 SET	1
1	6024687	cable trumpet 42T 25m H07 7G1,5 KIT	1
1	6032527	cable trumpet 42T 30m H07 7G1,5 KIT	1
1	6066420	cable trumpet 42T 35m H07 7G1,5 KIT	1
1	6000692	cable trumpet 42T 5m H07 10G1,5 KIT	1
1	6001115	cable trumpet 42T 10m H07 10G1,5 KIT	1
1	6000693	cable trumpet 42T 15m H07 10G1,5 KIT	1
1	6000694	cable trumpet 42T 20m H07 10G1,5 KIT	1
1	6046176	cable trumpet 42T 25m H07 10G1,5 KIT	1
2	6038293	cable trumpet 42T 10m S07RN-F 4G6(4x1)	1
3	6000699	cable trumpet 42T 5m NSS 2x1,5 KIT	1
3	6000700	cable trumpet 42T 10m NSS 2x1,5 KIT	1
3	6000701	cable trumpet 42T 15m NSS 2x1,5 KIT	1
3	6000702	cable trumpet 42T 20m NSS 2x1,5 KIT	1
3	6075910	cable trumpet 42T 25m NSS 2x1,5 KIT	1
3	6061578	cable trumpet 42T 30m NSS 2x1,5 KIT	1
3	6065996	cable trumpet 42T 45m NSS 2x1,5 KIT	1
3	6000703	cable trumpet 42T 5m NSS 4x1,5 KIT	1
3	6000704	cable trumpet 42T 10m NSS 4x1,5 KIT	1
3	6000705	Cable Trumpet 42T 15m NSS 4x1,5 KIT	1
3	6000706	cable trumpet 42T 20m NSS 4x1,5 KIT	1
3	6020376	cable trumpet 42T 25m NSS 4x1,5 KIT	1
3	6019867	cable trumpet 42T 30m NSS 4x1,5 KIT	1

cable trumpet 42T KIT

Item	Article no.	Description	Quantity
3	6036907	cable trumpet 42T 35m NSS 4x1,5 KIT	1
3	6038670	cable trumpet 42T 50m NSS 4x1,5 KIT	1
3	6040496	cable trumpet 42T 60m NSS 4x1,5 KIT	1
3	6000707	cable trumpet 42T 5m NSS 4x2,5 KIT	1
3	6000708	cable trumpet 42T 10m NSS 4x2,5 KIT	1
3	6000709	cable trumpet 42T 15m NSS 4x2,5 KIT	1
3	6001426	cable trumpet 42T 20m NSS 4x2,5 KIT	1
3	6066888	cable trumpet 42T 25m NSS 4x2,5 KIT	1
3	6001427	cable trumpet 42T 5m NSS 4x4 KIT	1
3	6001428	cable trumpet 42T 10m NSS 4x4 KIT	1
3	6001429	cable trumpet 42T 15m NSS 4x4 KIT	1
3	6001430	cable trumpet 42T 20m NSS 4x4 KIT	1
3	6075909	cable trumpet 42T 25m NSS 4x4 KIT	1
3	6067861	cable trumpet 42T 30m NSS 4x4 KIT	1
3	6072786	cable trumpet 42T 10m NSS 4x6 KIT	1
3	6066425	cable trumpet 42T 15m NSS 4x6 KIT	1
3	6068990	cable trumpet 42T 20m NSS 4x6 KIT	1
3	6065995	cable trumpet 42T 30m NSS 4x6 KIT	1
3	6065994	cable trumpet 42T 45m NSS 4x6 KIT	1
3	6040497	cable trumpet 42T 60m NSS 4x6 KIT	1
3	6044835	cable trumpet 42T 10m NSS 4x10 KIT	1
3	6067481	cable trumpet 42T 15m NSS 4x10 KIT	1
3	6070122	cable trumpet 42T 30m NSS 4x10 KIT	1
3	6001431	cable trumpet 42T 5m NSS 7x1,5 KIT	1
3	6001432	cable trumpet 42T 10m NSS 7x1,5 KIT	1
3	6001433	cable trumpet 42T 15m NSS 7x1,5 KIT	1
3	6001434	cable trumpet 42T 20m NSS 7x1,5 KIT	1
3	6040684	cable trumpet 42T 25m NSS 7x1,5 KIT	1
3	6074636	cable trumpet 42T 40m NSS 7x1,5 KIT	1
3	6001435	cable trumpet 42T 5m NSS 7x2,5 KIT	1
3	6001436	cable trumpet 42T 10M NSS 7x2,5 KIT	1
3	6001437	cable trumpet 42T 15m NSS 7x2,5 KIT	1
3	6001438	cable trumpet 42T 20m NSS 7x2,5 KIT	1
3	6036937	cable trumpet 42T 25m NSS 7x2,5 KIT	1

cable trumpet 42T KIT

Item	Article no.	Description	Quantity
3	6036906	cable trumpet 42T 35m NSS 7x2,5 KIT	1
3	6086145	cable trumpet 42T 10m NSS 10x1,5 SET	1
3	6068144	cable trumpet 42T 15m NSS 10x1,5 KIT	1
3	6078651	cable trumpet 42T 20m NSS 10x1,5 SET	1
3	6078807	cable trumpet 42T 25m NSS 10x1,5 SET	1
4	6046317	cable trumpet 42T 10m S07RC4N-F 4x1,5	1
4	6063563	cable trumpet 42T 40m S07RC4N-F 4x1,5	1
4	6066388	cable trumpet 42T 10m S07RC4N-F 7x1,5KIT	1
4	6061983	cable trumpet 42T 15m S07RC4N-F 4x1,5KIT	1
4	6046316	cable trumpet 42T 20m S07RC4N-F 4x4	1
5	6065152	cable trumpet 42T 10m 2* AWG14	1
5	6065153	cable trumpet 42T 20m 2* AWG14	1
5	6066488	cable trumpet 42T 20m 4* AWG14	1
5	6065151	cable trumpet 42T 10m 7* AWG14	1
5	6066489	cable trumpet 42T 20m 7* AWG14	1
5	6065150	cable trumpet 42T 10m 4* AWG10	1
6	2132620	on request	1

7	6067898	cable trumpet 42T 10m S07RC4N-F 12G1,5 C	1
8	6019360	cable trumpet 42T 5m H07 7G1,5 C KIT	1
8	6019362	cable trumpet 42T 15m H07 7G1,5 C KIT	1
9	6037455	cable trumpet 42T 10m NSS 4x1,5 C KIT	1
9	6019374	cable trumpet 42T 15m NSS 4x2,5 C KIT	1
9	6019381	cable trumpet 42T 10m NSS 7x1,5 C KIT	1
9	6019382	cable trumpet 42T 15m NSS 7x1,5 C KIT	1
9	6037454	cable trumpet 42T 10m NSS 7x2,5 C KIT	1
9	6019387	cable trumpet 42T 20m NSS 7x2,5 C KIT	1
9	6079792	cable trumpet 42T 30m NSS 7x2,5 C KIT	1
10	6019849	cable trumpet 42T RF 10m H07 7G1,5 KIT	1
10	6035148	cable trumpet 42T RF 15m H07 7G1,5 KIT	1
10	6038689	cable trumpet 42T RF 20m H07 7G1,5 KIT	1
11	6032612	cable trumpet 42T RF 10m NSS 7x1,5 KIT	1
11	6034277	cable trumpet 42T RF 30m NSS 7x1,5 KIT	1

cable trumpet 42T KIT

Item	Article no.	Description	Quantity
12	6044717	plug 42T KIT	1
13	6070010	cable trumpet 42T 15m NSSHC 3x16+3x2,5	1
14	6044834	cable trumpet 42T 10m NSS 4x16 KIT	1
14	6067480	cable trumpet 42T 15m NSS 4x16 KIT	1
14	6066168	cable trumpet 42T 20m NSS 4x16 KIT	1
14	6069678	cable trumpet 42T 25m NSS 4x16 KIT	1
14	6081974	cable trumpet 42T 40m NSS 4x16 KIT	1
15	6063562	cable trumpet 42T 40m S07RC4N-F 4x16	1
16	6067560	cable trumpet 42T 20m 4* AWG6	1