

## PLAGES D'UTILISATION

Débits jusqu'à :	450 m <sup>3</sup> /h
Hauteurs mano. jusqu'à :	150 mCE
Pression de service :	16 bar
Plage de température :	-20 à +120°C
Eau chaude jusqu'à :	+120°C
MEI* de référence :	≥ 0,10

\*Minimum Efficiency Index

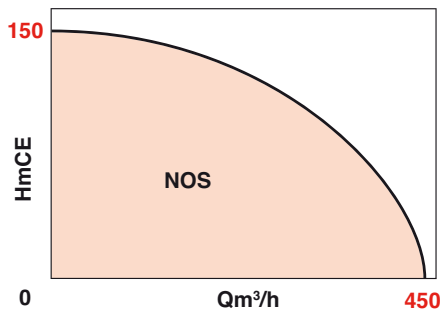

## AVANTAGES

- Performances hydrauliques et cotes fonctionnelles de raccordement conformes à la norme EN 733 en 39 tailles.
- Arbre et paliers renforcés pour répondre à la norme ISO 5199.
- La gamme standard est équipée de châssis fonte pour assurer une meilleure rigidité de l'ensemble.
- Maintenance aisée grâce au système "process" permettant le démontage du mobile sans débrider le corps de pompe ni déplacer le moteur (avec l'option spacer).

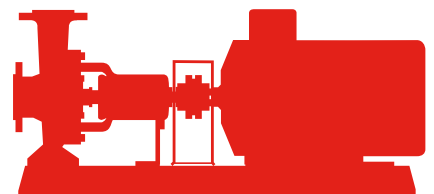
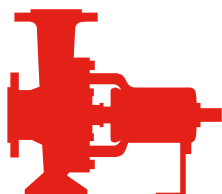

# NOS

## POMPES CENTRIFUGES MONOCELLAIRES NORMALISEES EN 733 (NFE 44111), ISO 5199 Chauffage - Climatisation Industrie - Agriculture

### APPLICATIONS

Pompage de fluides clairs ou légèrement troubles sans particules solides dans les domaines d'applications suivants :

- Chauffage et climatisation.
- Industrie générale, plastique, peinture, textile, papier, etc.
- Industrie alimentaires, pharmaceutique, etc.
- Lutttes contre l'incendie\*
- Relevage d'effluents

• ACS sur demande

\* bien respecter les vitesses maximales pompes préconisées

• NOS version arbre nu

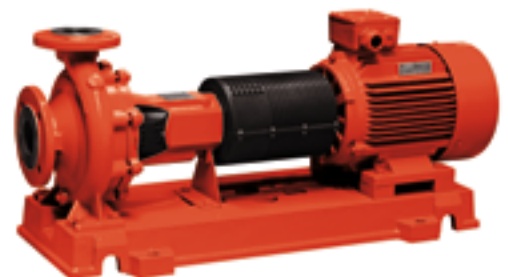

# NOS

## CONCEPTION

### Partie hydraulique :

- Centrifuge monocellulaire, axe horizontal. Aspiration axiale, refoulement radial vers le haut.
- Pattes de fixation sous le corps.
- Palier monobloc, roulements renforcés de guidage de l'arbre lubrifiés par graisse ou par bain d'huile (selon l'option).
- Étanchéité par garniture mécanique directement montée sur l'arbre ou par tresse avec chemise d'arbre.
- Adaptation du diamètre de la roue pour obtenir un point de fonctionnement donné.

### Moteur

Normalisé selon I.E.C. et DIN/VDE 0530	
Vitesse :	1450 – 2900 tr/min
Tension :	230 / 400 V
au delà de 4 kW :	400 / 690V
Fréquence :	50 Hz - 60 Hz*
Classe d'isolation :	155 (F)
Protection :	IP 55
Conformité CE :	EN 809

\* (Nous consulter)

## DESCRIPTION

### Raccordement de brides :

Matière ML : DIN 2533 PN 16

### Paliers :

Paliers de 25, 35 et 45 : deux roulements à billes, graissés à vie (2Z), désignation B, ou lubrification par huile, désignation C.

**Observation :** les recommandations techniques et les règles de sécurité doivent être observées. (Consulter la notice de mise en service)

**Orientation des brides :** Bride d'aspiration axiale, bride de refoulement radiale vers le haut.

### Étanchéité de corps :

Le matériau standard est de la fibre.

## SPECIFICATION

### Corps

Ouvert côté entraînement pour permettre le démontage par l'arrière de l'ensemble mécanique. Pattes de fixation sous la volute.

Aspiration axiale, refoulement radial vers le haut.

Brides usinées selon la norme NFE 29201 (DIN 2533).

-Brides PN16.

### Fond

Fixé entre le corps et le palier. Prévu avec un logement recevant le système d'étanchéité d'arbre, garniture mécanique ou tresses.

### Palier

Monobloc, largement dimensionné pour répondre à la norme ISO 5199 et supporté par une béquille. Roulements à billes à gorge profonde de guidage de l'arbre, lubrifiés par graisse. Un déflecteur centrifuge assure la protection contre toute pénétration de liquide.

### Arbre

Largement dimensionné pour répondre à la norme ISO 5199, il accroît la durée de vie de la garniture d'étanchéité. Chemisé avec garniture tresse.

### Roue

Fonte ou bronze.

Fermée haut rendement, radiale avec étanchéité arrière et trous d'équilibrage. Adaptée (rognée) sur demande pour l'obtention du Q/H requis par l'installation.

Inox sur demande.

### Étanchéité d'arbre

Par garniture mécanique simple normalisée, adaptée au liquide pompé, ne nécessitant aucun entretien en cours de fonctionnement. Tresse possible sur demande.

Garniture carbure/carbure EPDM ou viton sur demande

### Accouplement

Standard, semi-élastique avec ou sans pièce d'espacement en fonction de la demande.

## IDENTIFICATION

NOS 32 / 200 B - 0.75 - 4 - 05

Code pompe normalisée	32	/	200	B	-	0.75	-	4	-	05
DN orifice de refoulement en mm	32									
Diamètre de roue maximum en mm			200							
Type hydraulique				B						
Puissance du moteur en Kw						0.75				
Rien = sans moteur										
Moteur 2 ou 4 pôles								4		
Rien = sans moteur										

Variantes de construction		Code	01	02	05	06	08	10	11	12	23	24	26	44
Type de pompe	Pompe + moteur + socle		.	.	.	.	.	.	.	.	.	.	.	.
	Pompe nue		.	.	.	.	.	.	.	.	.	.	.	.
Accoup.	Avec spacer		.	.	.	.	.	.	.	.	.	.	.	.
	Sans spacer		.	.	.	.	.	.	.	.	.	.	.	.
Corps	EN GJL 250		.	.	.	.	.	.	.	.	.	.	.	.
	EN GJL 250		.	.	.	.	.	.	.	.	.	.	.	.
Roue	CUSN8		.	.	.	.	.	.	.	.	.	.	.	.
	X20Cr13		.	.	.	.	.	.	.	.	.	.	.	.
Arbre	X20Cr13		.	.	.	.	.	.	.	.	.	.	.	.
Ch. Arbre	X20Cr13		.	.	.	.	.	.	.	.	.	.	.	.
Tresse	GRAPHITE / PTFE		.	.	.	.	.	.	.	.	.	.	.	.
G.M.	Carbone/Carbure Si/EPDM		.	.	.	.	.	.	.	.	.	.	.	.

## DESCRIPTION

Palier en fonction des tailles de pompe :

Palier de 25	32/125	32/160	32/200	32/250	40/125	40/160	40/200	40/250	50/125	50/160	50/200	50/250	65/125	65/160	65/200	80/160
Palier de 35	40/315	50/315	65/250	65/315	80/200	80/250	80/315	100/160	100/200	100/250	100/315	125/200	125/250	150/200	150/250	
Palier de 45	80/400	100/400	125/315	125/400	150/315	150/400										

### Puissance moteur :

Les moteurs électriques standards équipant les pompes NOS sont de type de construction IM B3.

Lors de la détermination de la puissance moteur, nous recommandons d'appliquer les marges de sécurité suivantes :

Jusqu'à 4 kW : +25%  
 de 4 à 7,5 kW : +20%  
 au delà de 7,5 kW : +15%

Les vitesses maximales suivantes doivent être respectées en fonction des tailles de pompes :

Modèle	Vmax. (min-1)	Modèle	Vmax. (min-1)	Modèle	Vmax. (min-1)
32/125	3600	32/250	3000	40/315	1800
32/160		40/250		50/315	
32/200		50/250		65/315	
40/125		65/250		80/315	
40/160		80/250		80/400	
40/200		100/250		100/315	
50/125		125/200		100/400	
50/160				125/250 125/315	
50/200				125/400	
65/125				150/200 150/250	
65/160 65/200		150/315 150/400			
80/160 80/200					
100/160 100/200					

## PLAN COUPE DE PRINCIPE

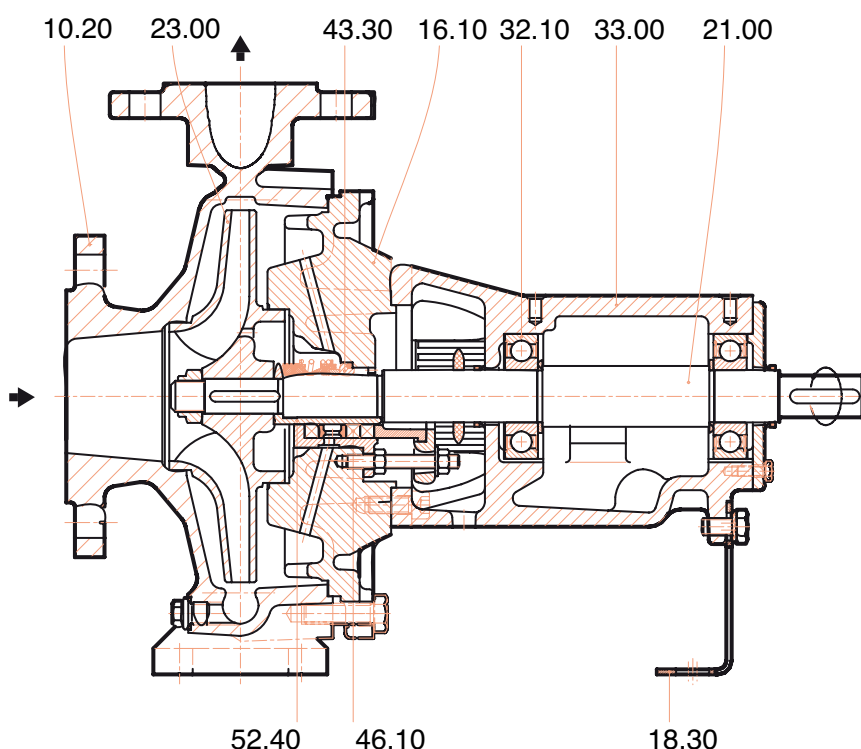

### Palier taille 25, 35, 45

- 10.20 volute
- 16.10 fond de volute
- 18.30 pied support
- 21.00 arbre
- 23.00 roue
- 32.10 roulement
- 33.00 corps de palier
- 43.30 garniture mécanique
- 46.10 boîtier de presse-étoupe
- 52.40 chemise d'arbre (presse-étoupe)

## GUIDE DE PRESELECTION HYDRAULIQUE

• 4 pôles

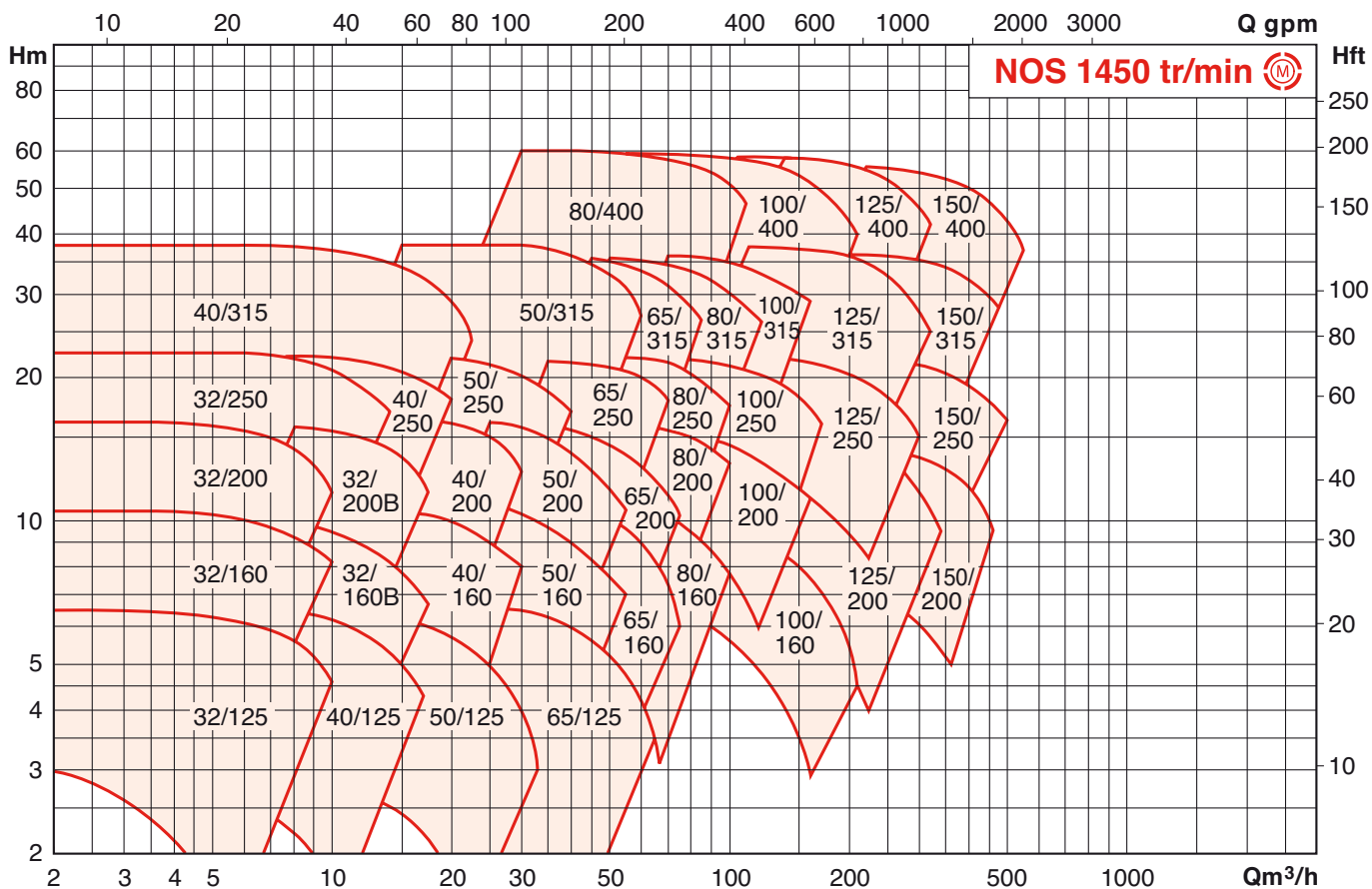

<b>4 pôles</b>	<b>4 pôles</b>	<b>4 pôles</b>
32/125	50/315	100/400
32/160A	65/125	125/200
32/160B	65/160	125/250
32/200A	65/200	125/315
32/200B	65/250	125/400
32/250	65/315	150/200
40/125	80/160	150/250
40/160	80/200	150/315
40/200	80/250	150/400
40/250	80/315	
40/315	80/400	
50/125	100/160	
50/160	100/200	
50/200	100/250	
50/250	100/315	

## GUIDE DE PRESELECTION HYDRAULIQUE

• 2 pôles

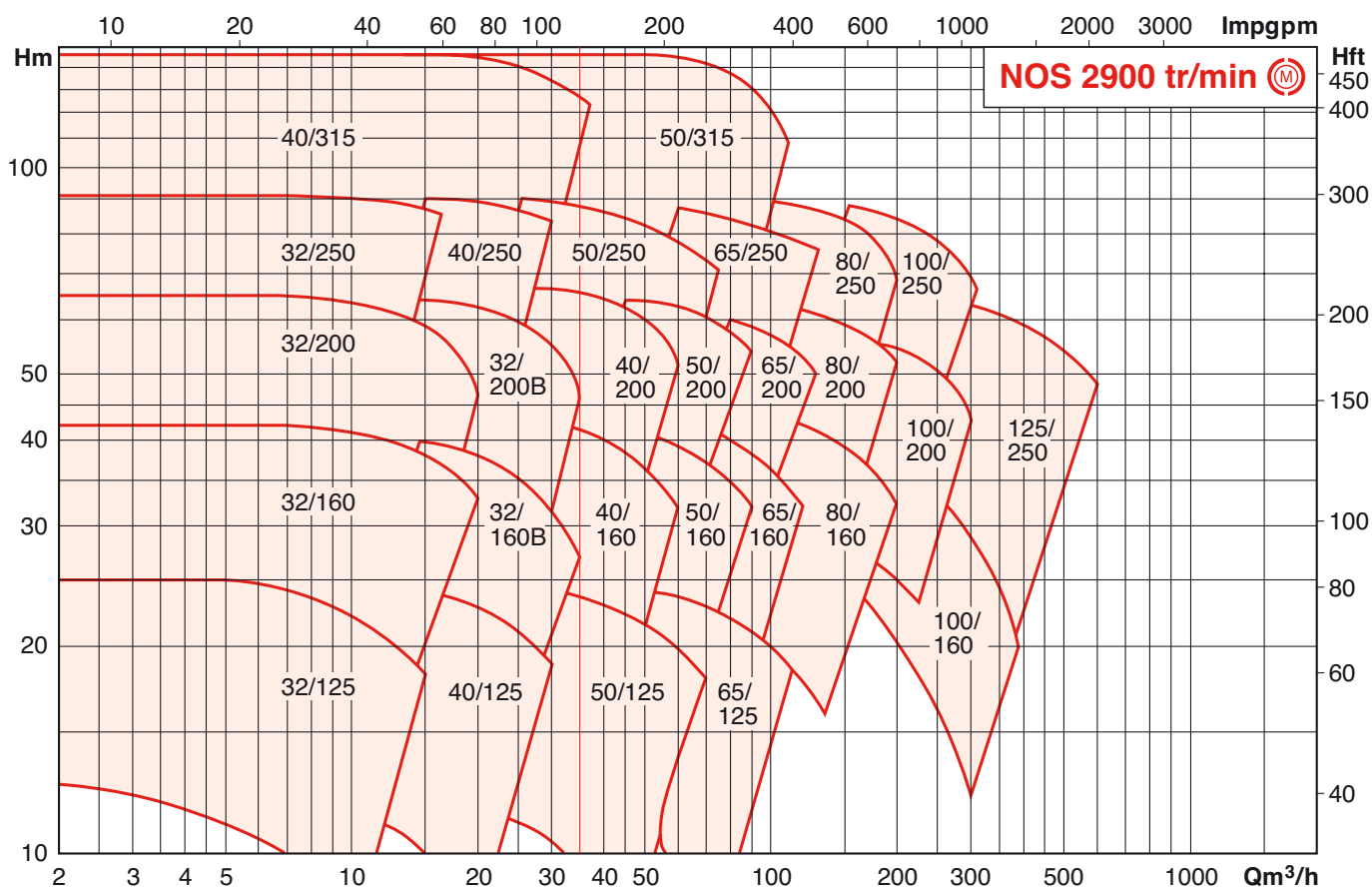

Génie climatique  
Pompes à rotor sec

2 pôles
32/125
32/160A
32/160B
32/200A
32/200B
32/250
40/125
40/160
40/200
40/250
40/315
50/125
50/160
50/200
50/250

2 pôles
50/315
65/125
65/160
65/200
65/250
80/160
80/200
80/250
100/160
100/200
100/250
125/200

## PERFORMANCES HYDRAULIQUES

## 1450 TR/MIN

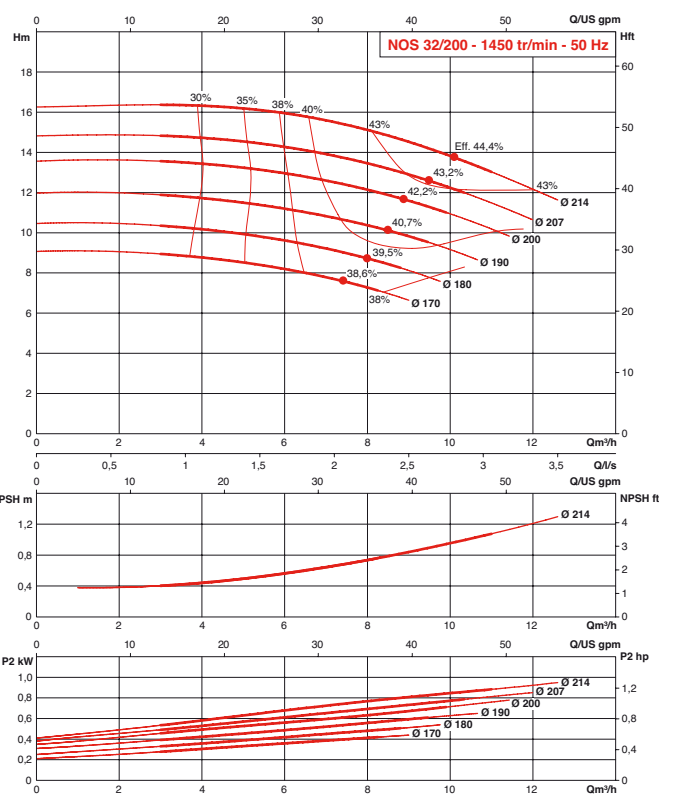
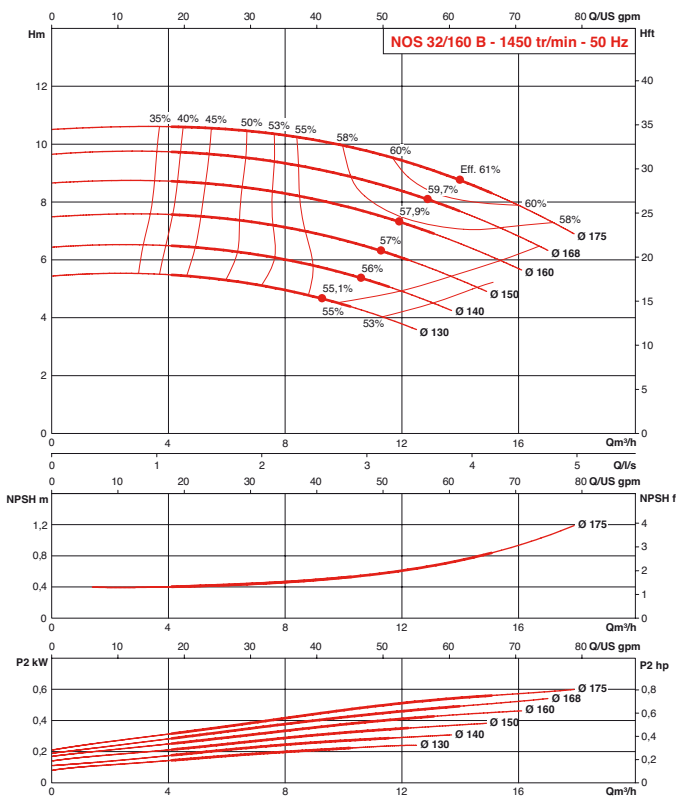
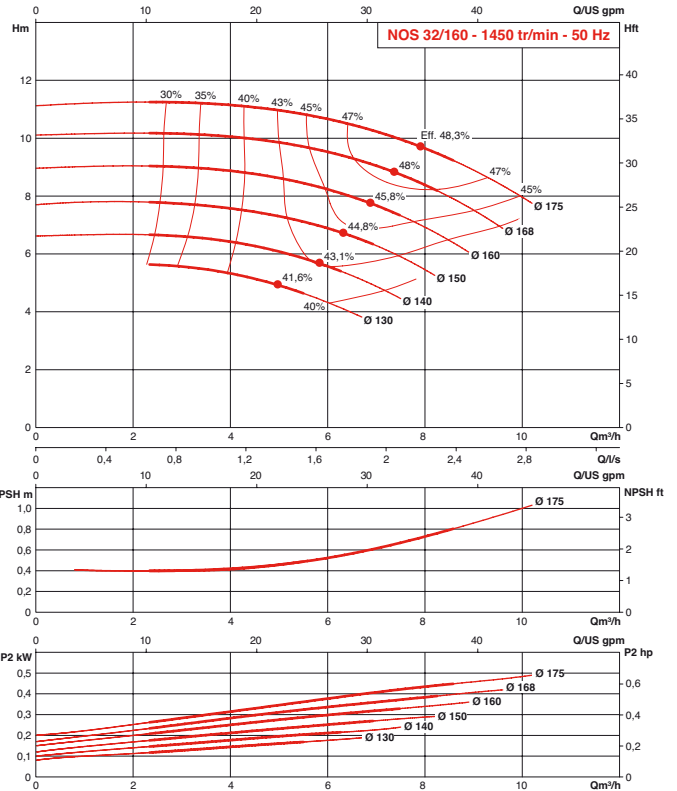
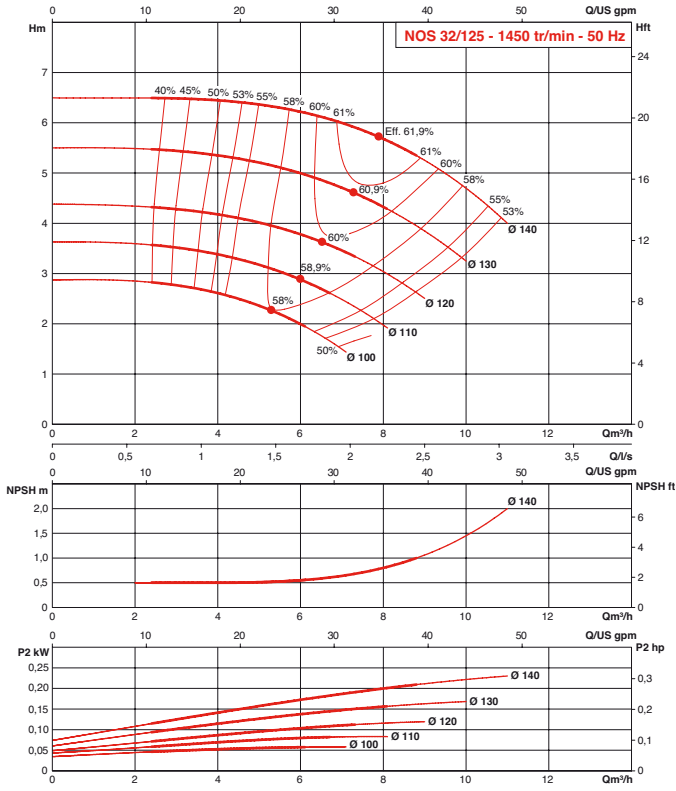

## PERFORMANCES HYDRAULIQUES

## 1450 TR/MIN

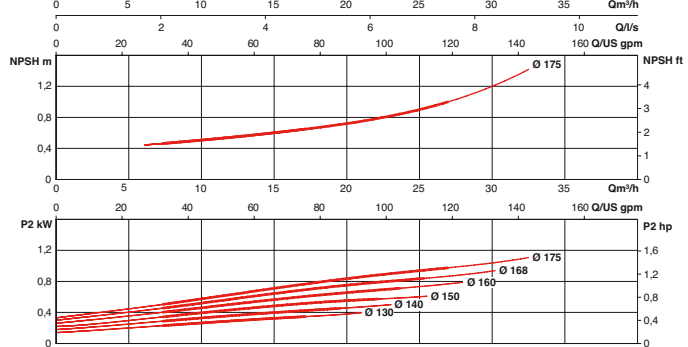
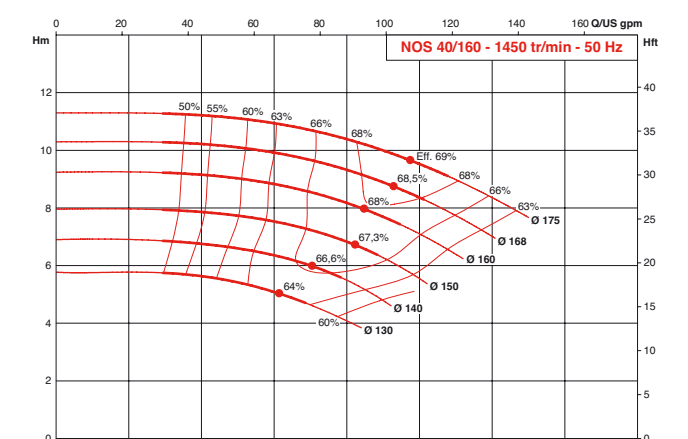
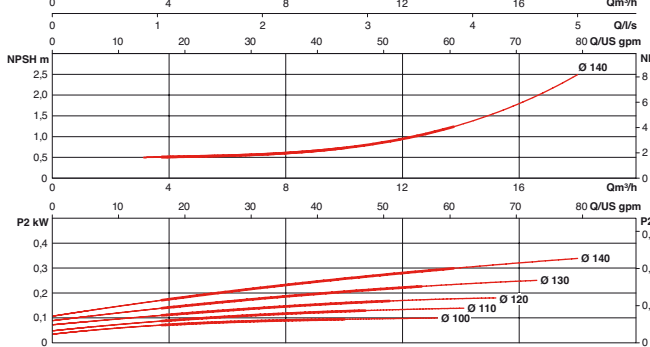
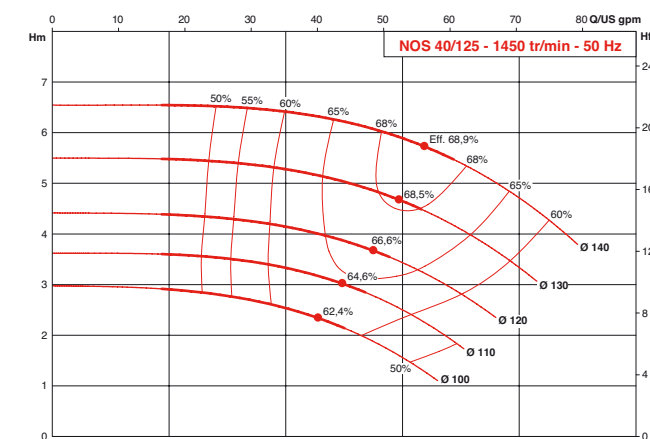
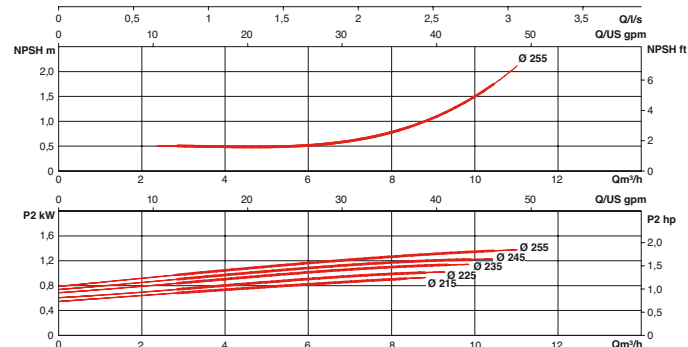
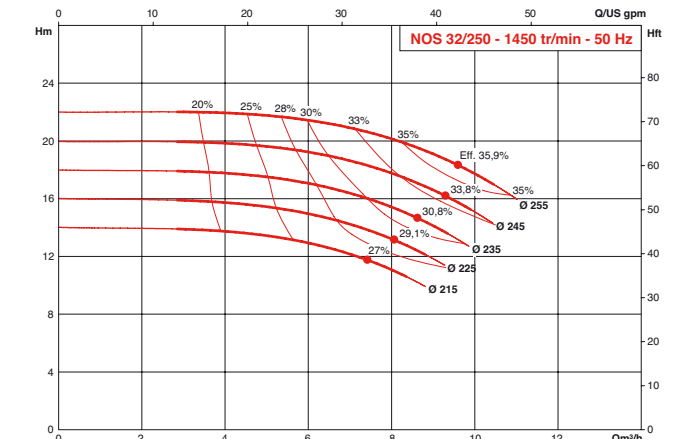
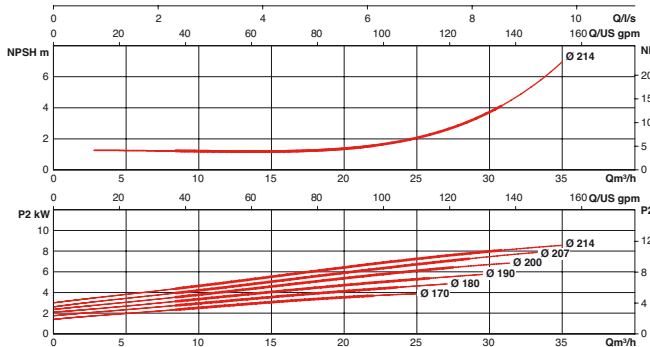
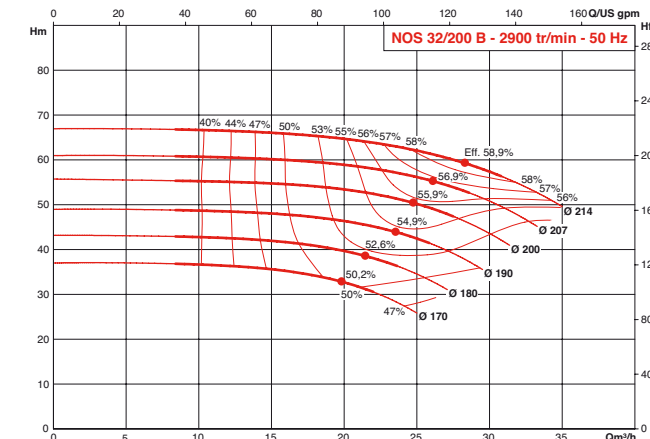

Génie climatique  
Pompes à rotor sec

## PERFORMANCES HYDRAULIQUES

## 1450 TR/MIN

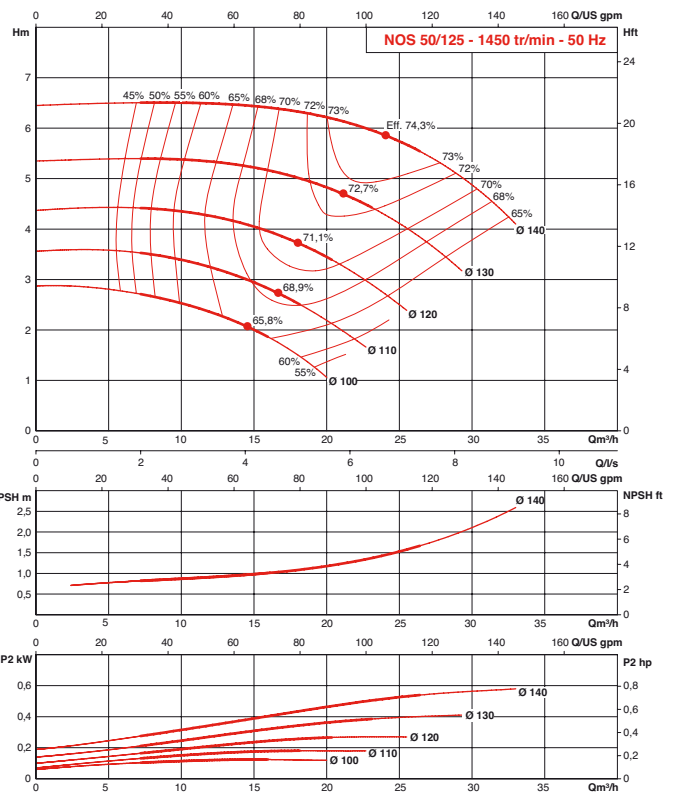
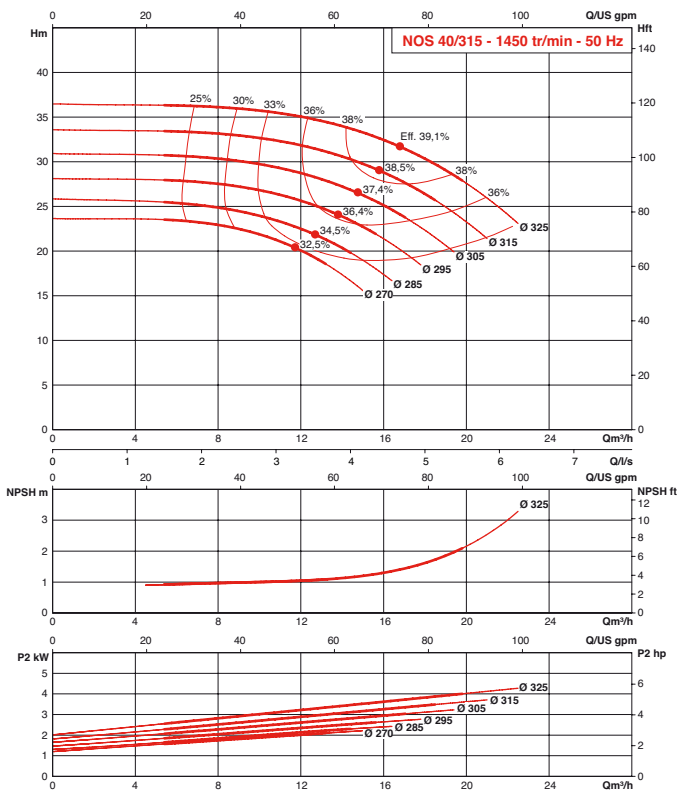
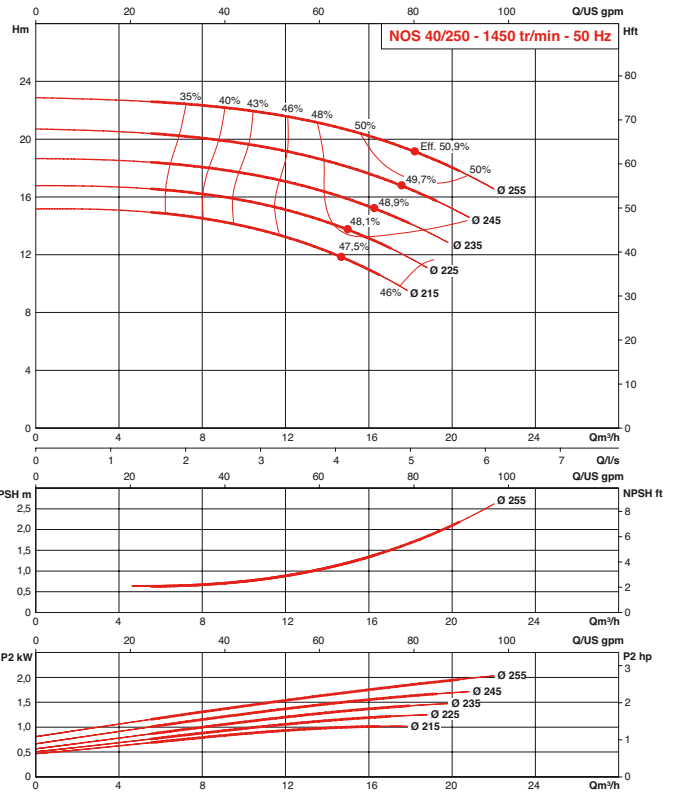
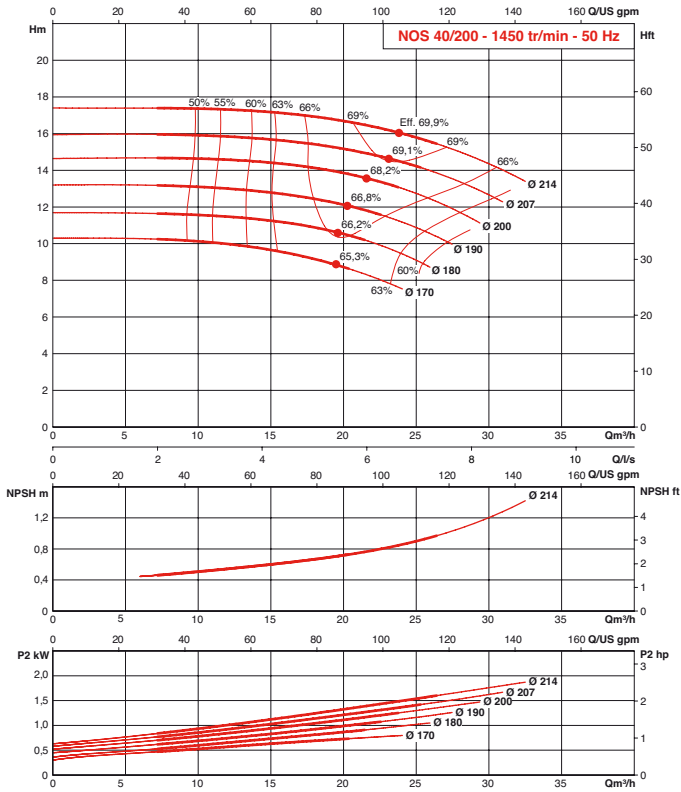



## PERFORMANCES HYDRAULIQUES

## 1450 TR/MIN

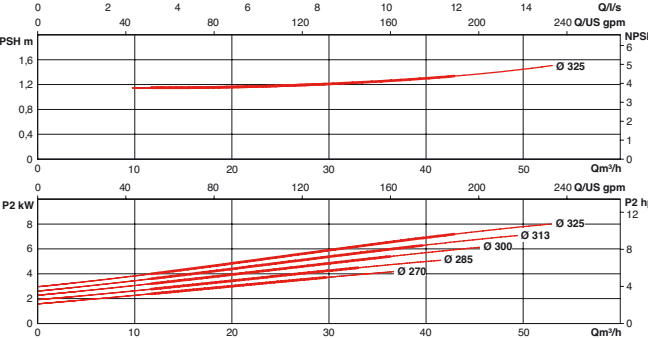
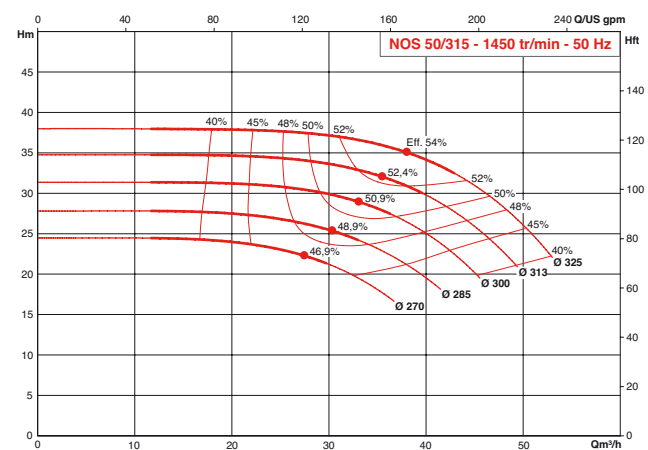
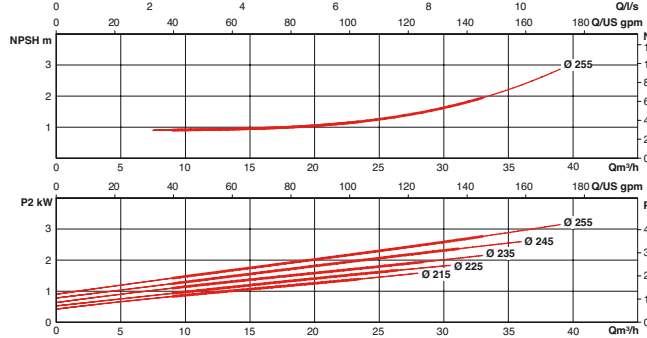
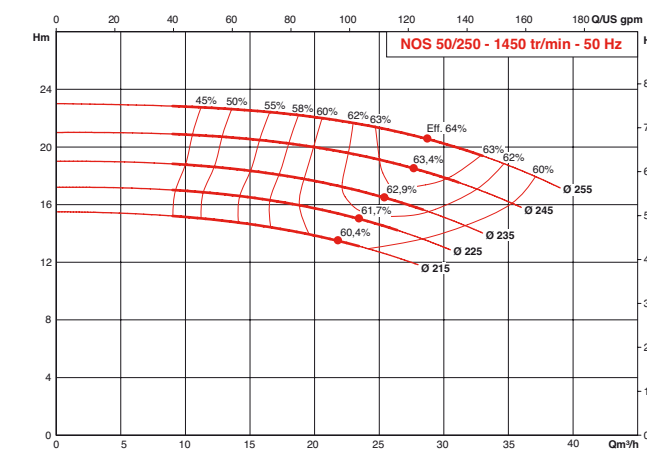
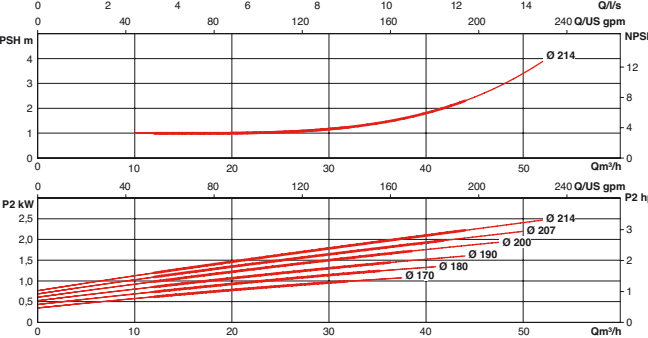
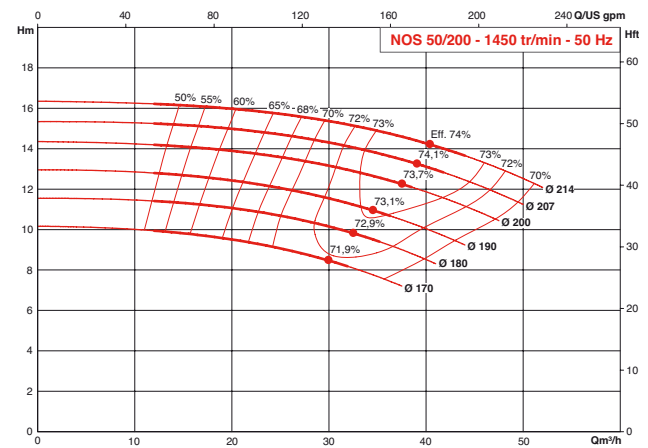
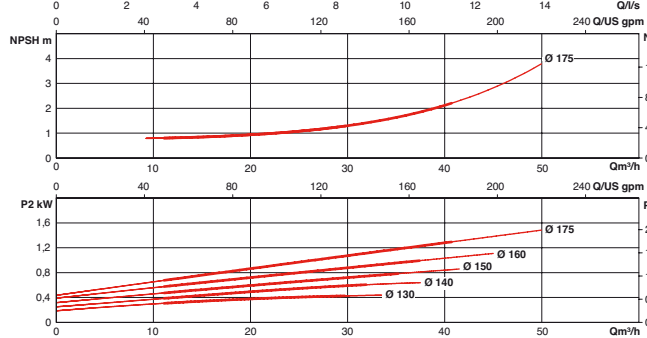
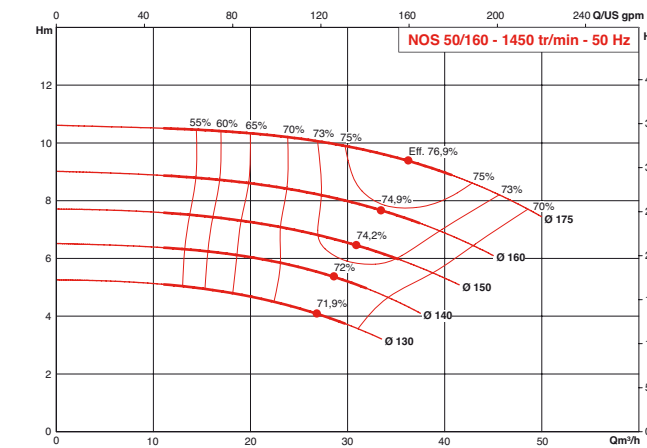

Génie climatique  
Pompes à rotor sec

## PERFORMANCES HYDRAULIQUES

## 1450 TR/MIN

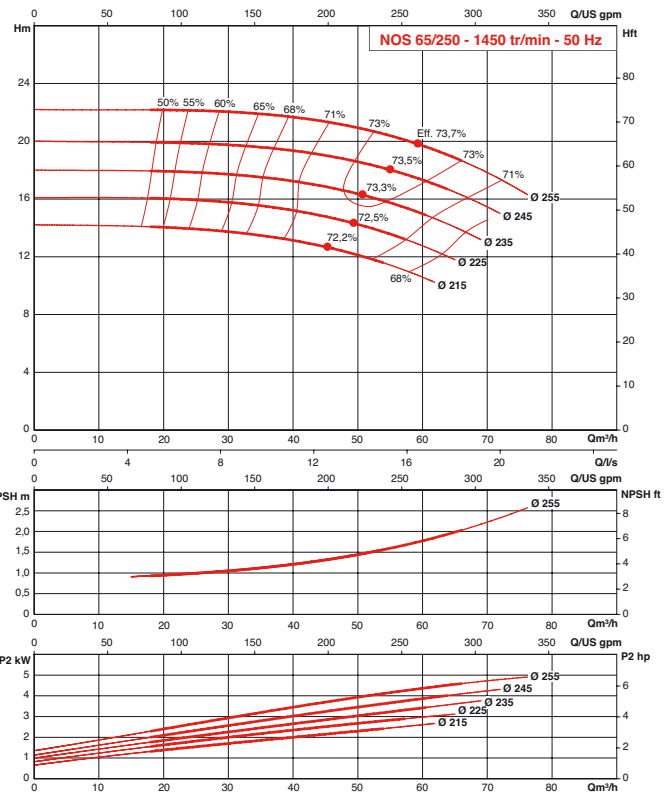
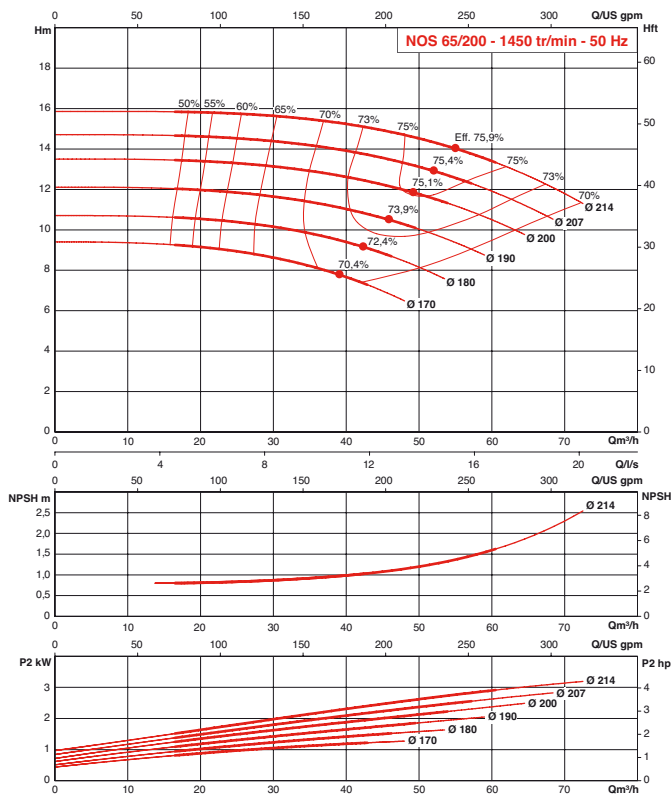
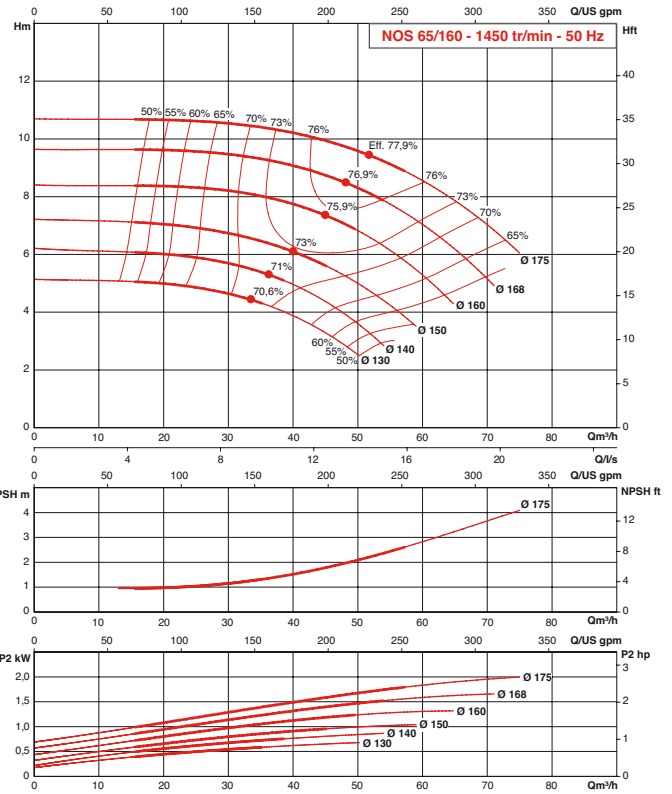
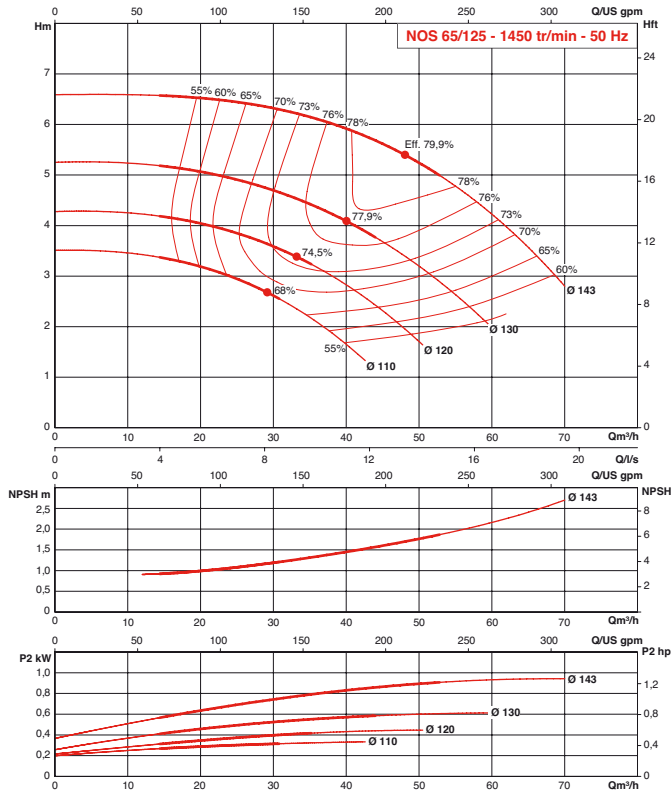

## PERFORMANCES HYDRAULIQUES

## 1450 TR/MIN

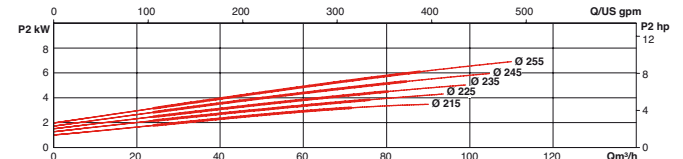
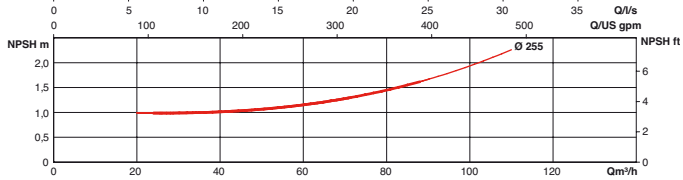
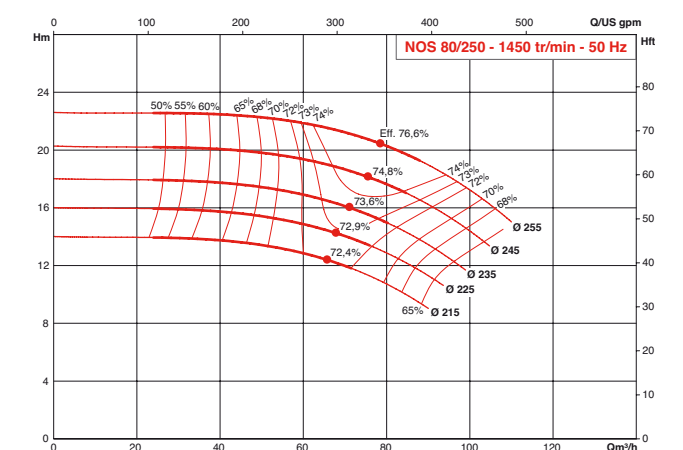
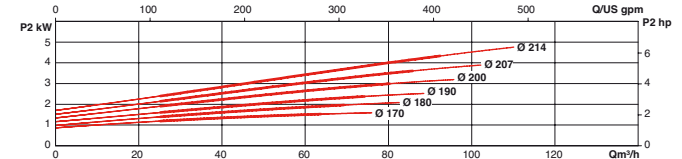
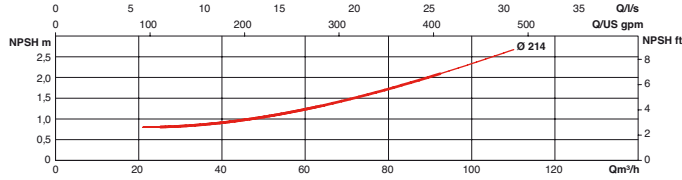
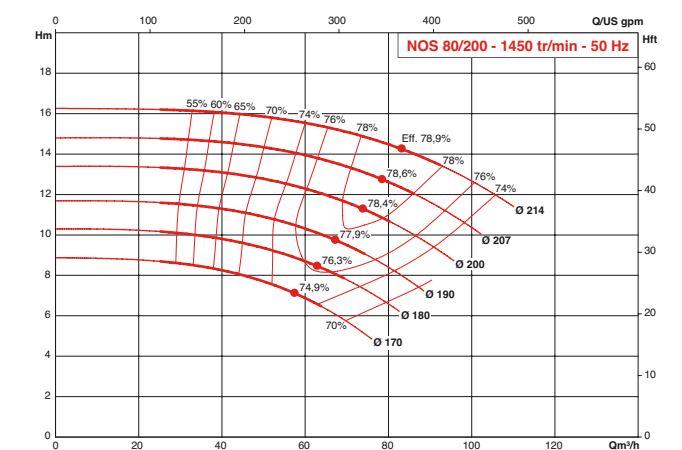
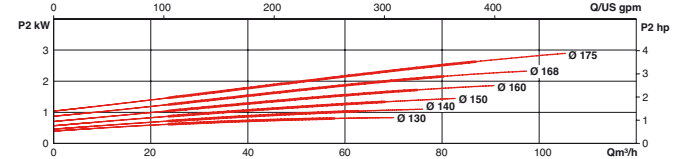
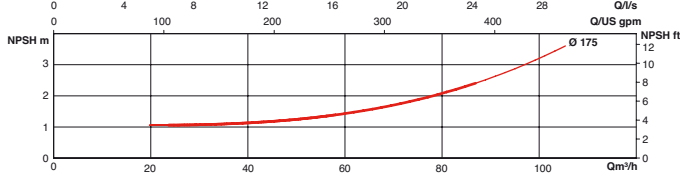
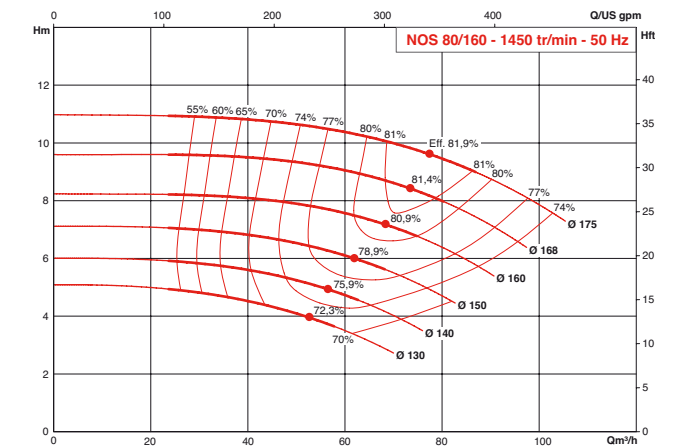
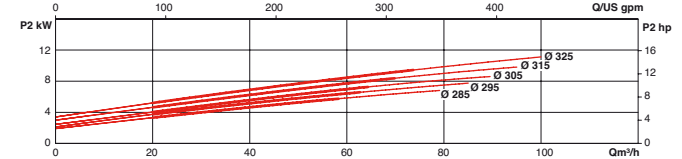
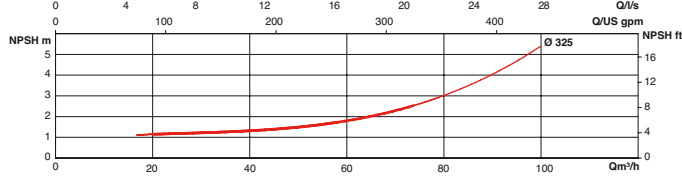
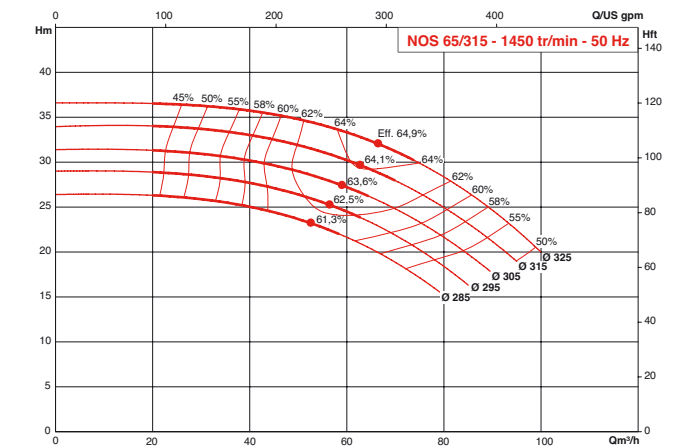

Génie climatique  
Pompes à rotor sec

## PERFORMANCES HYDRAULIQUES

## 1450 TR/MIN

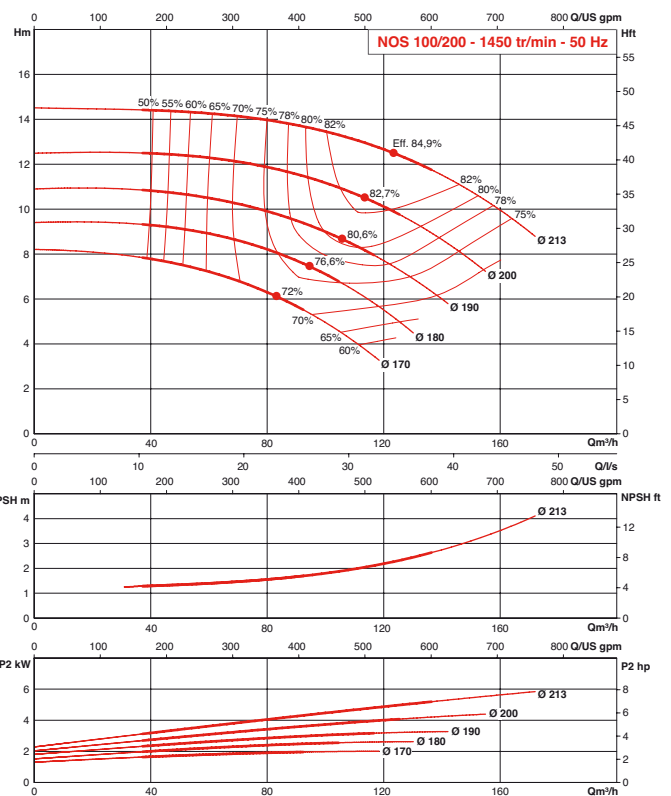
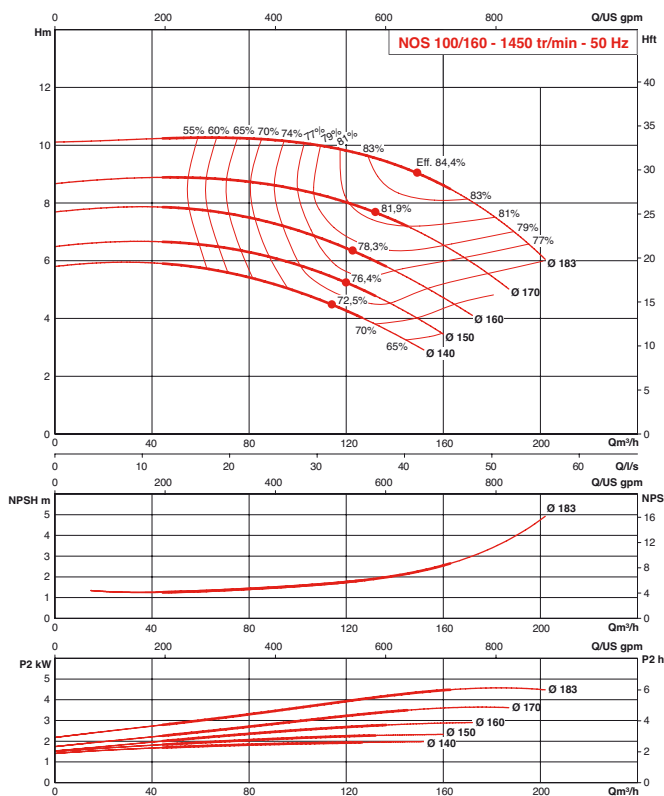
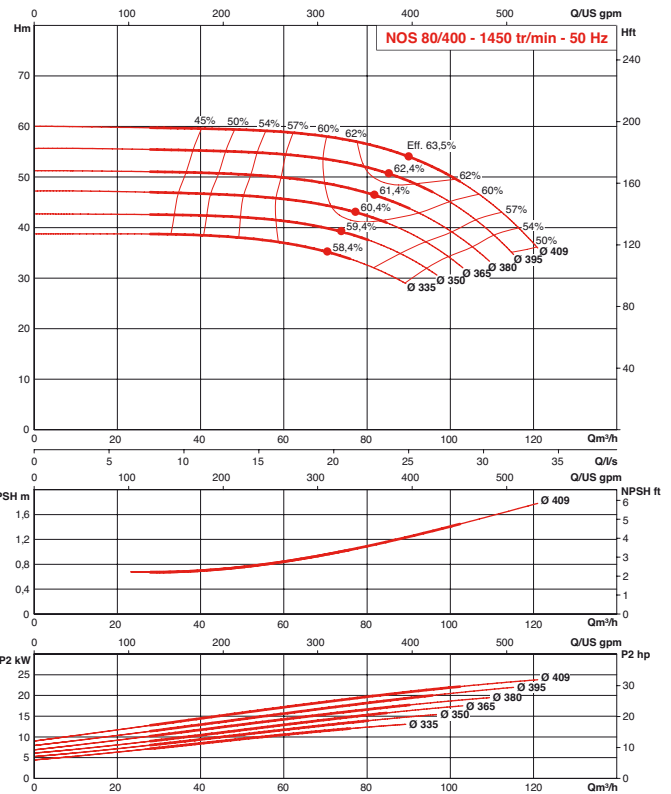
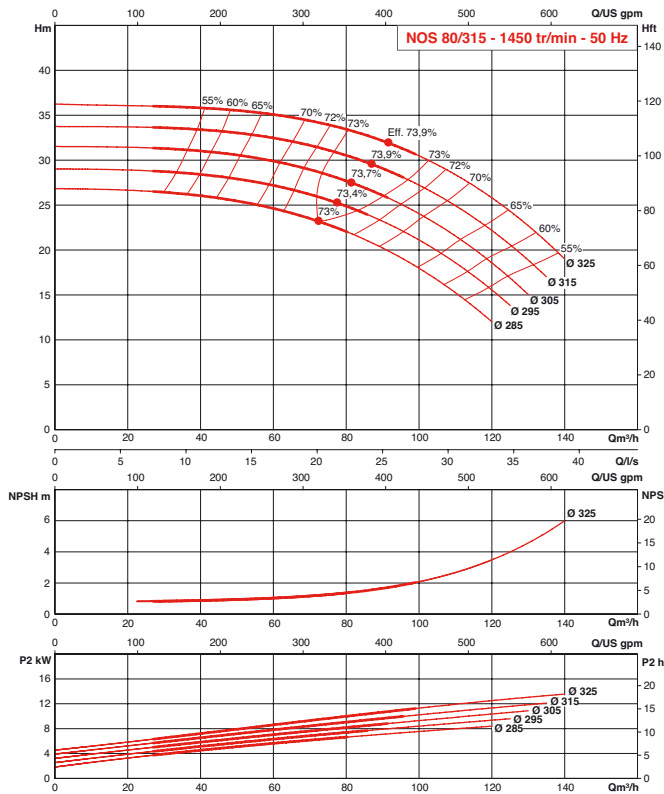

## PERFORMANCES HYDRAULIQUES

## 1450 TR/MIN

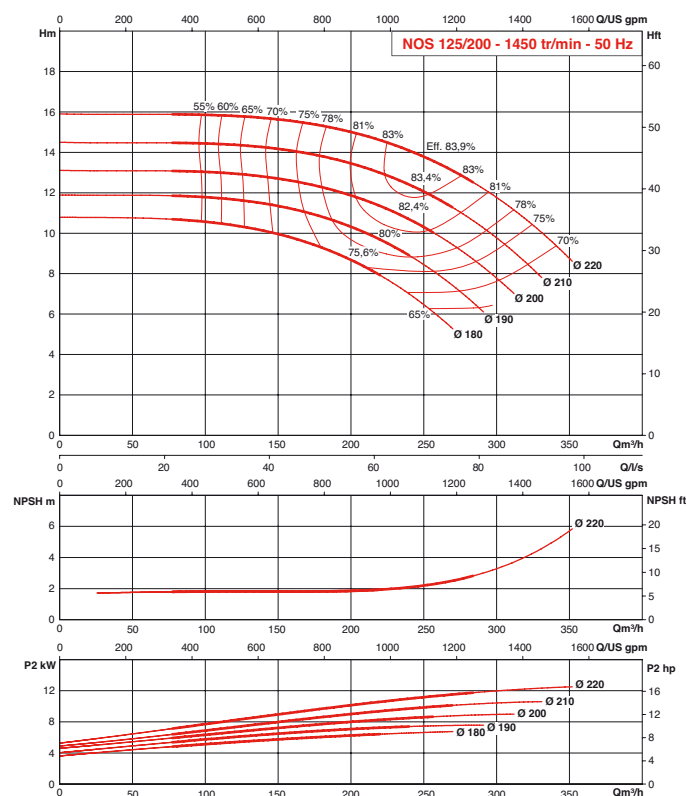
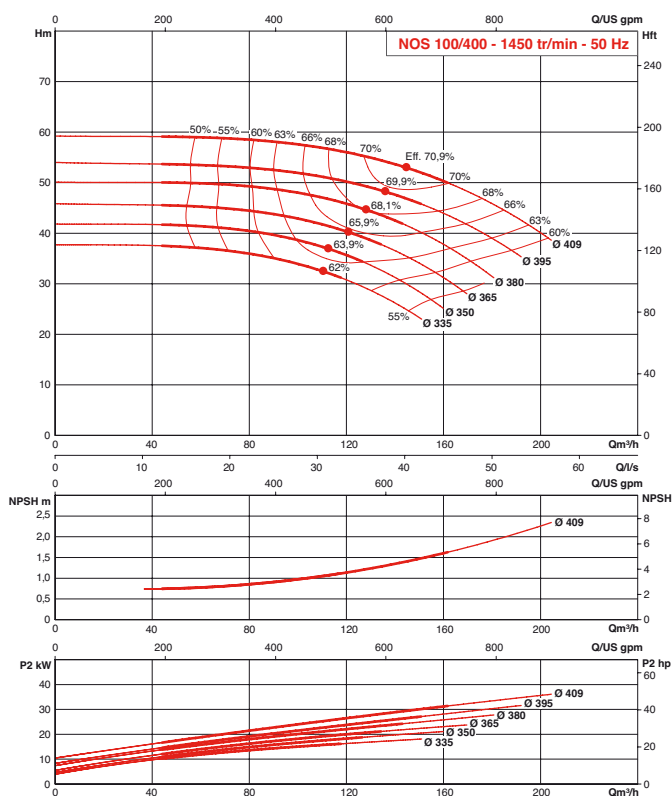
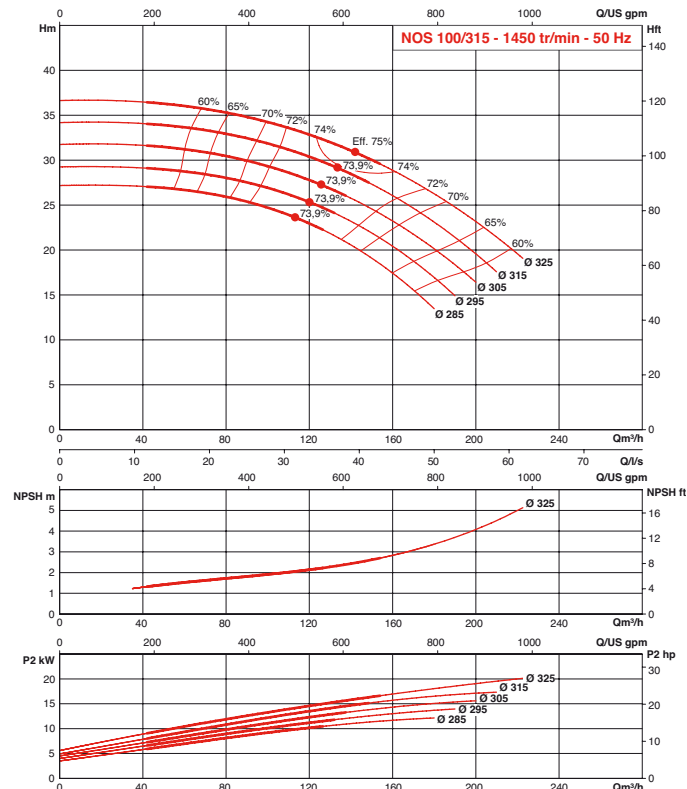
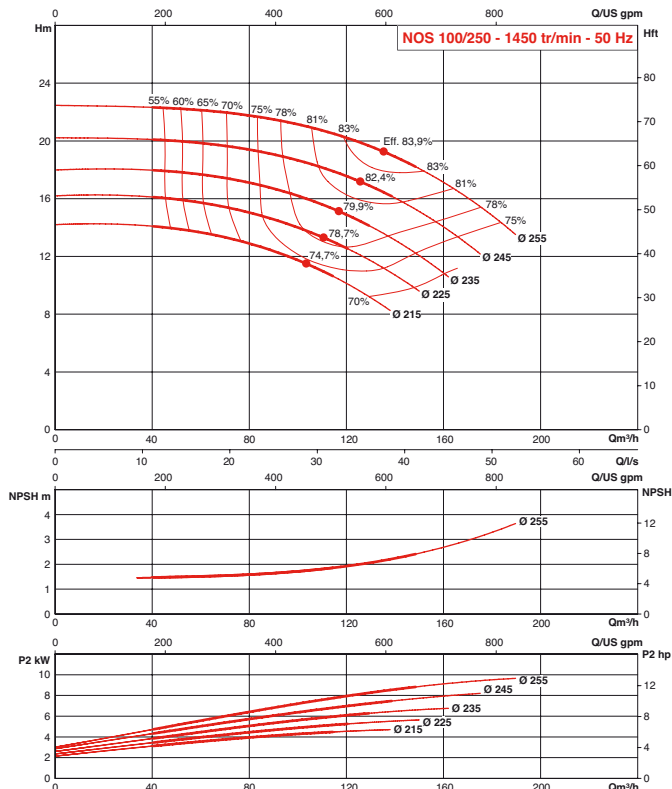

## PERFORMANCES HYDRAULIQUES

## 1450 TR/MIN

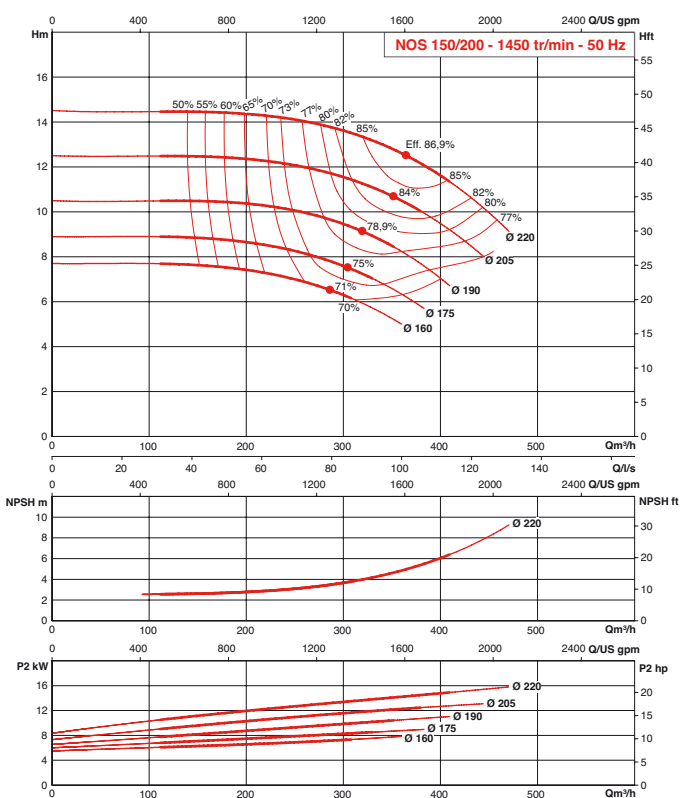
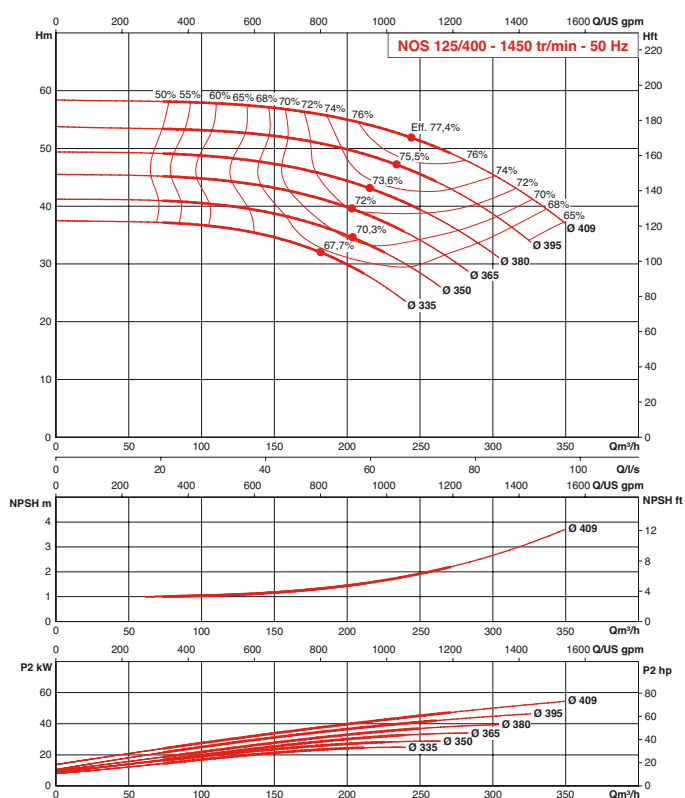
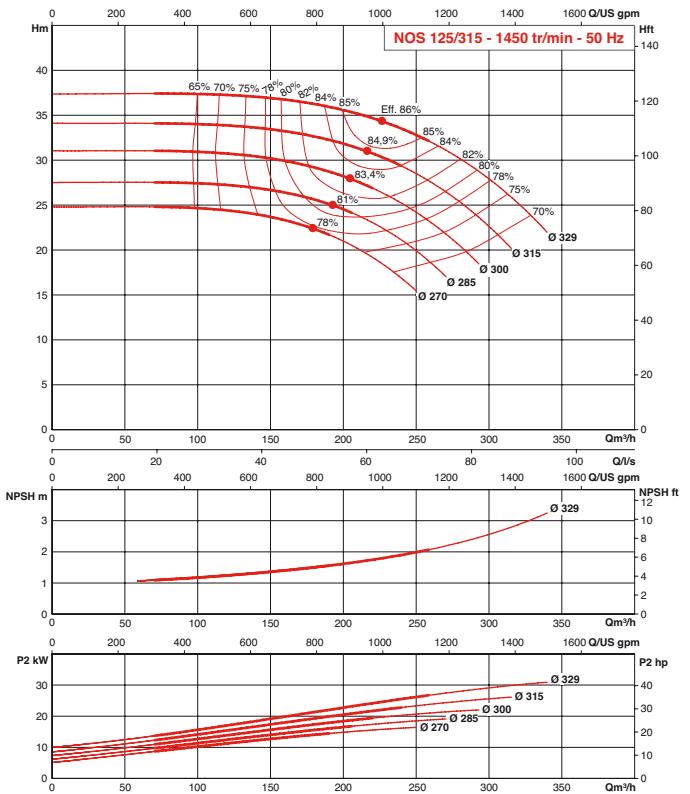
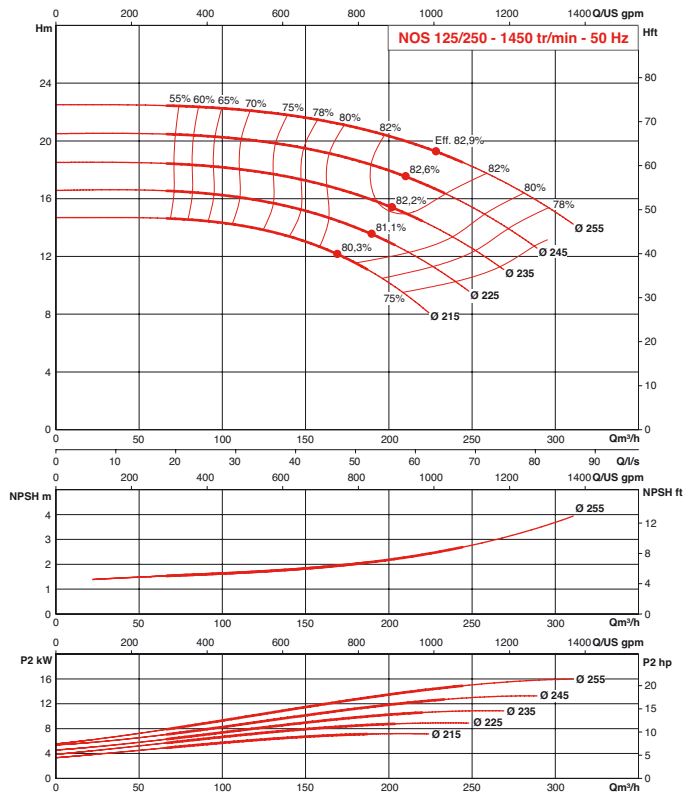

## PERFORMANCES HYDRAULIQUES

## 1450 TR/MIN

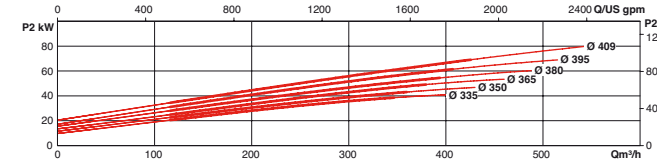
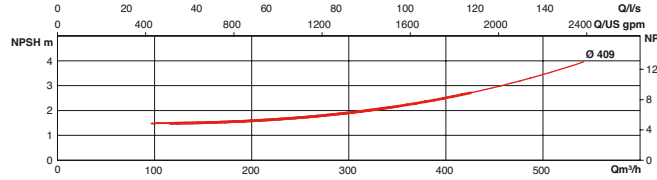
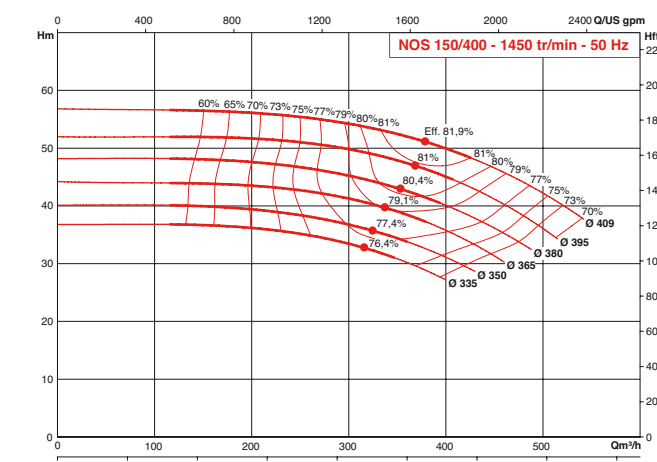
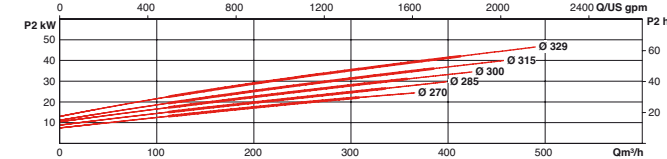
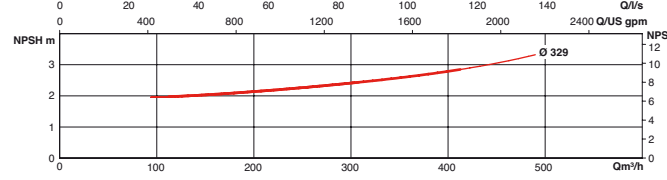
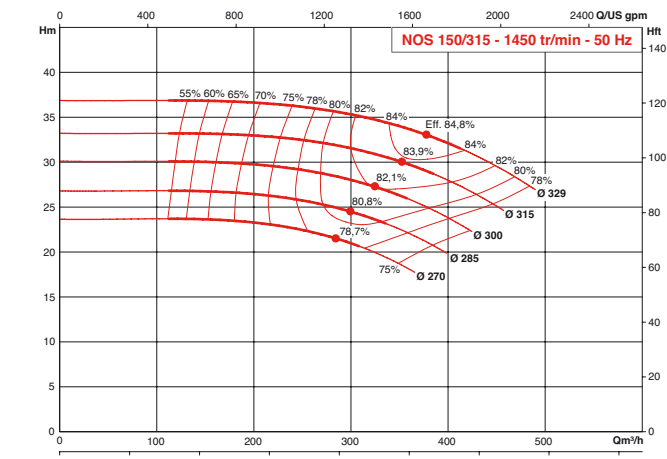
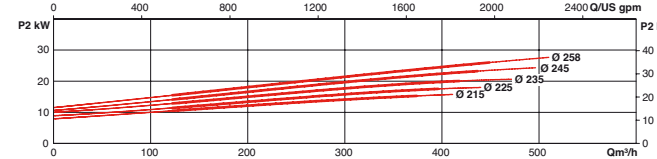
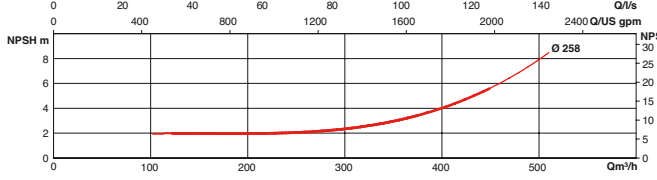
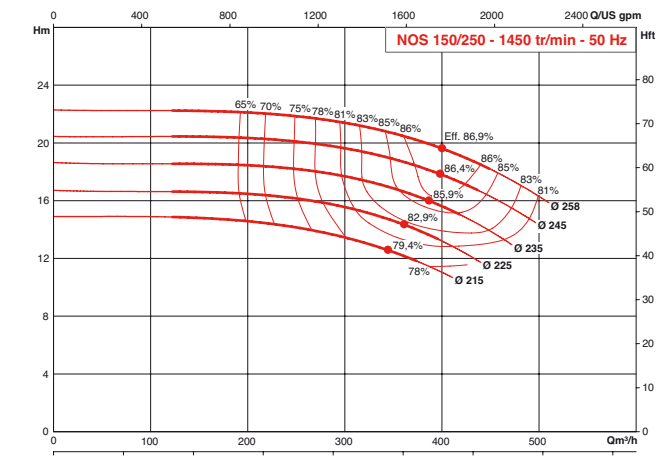

Génie climatique  
Pompes à rotor sec

## PERFORMANCES HYDRAULIQUES

## 2900 TR/MIN

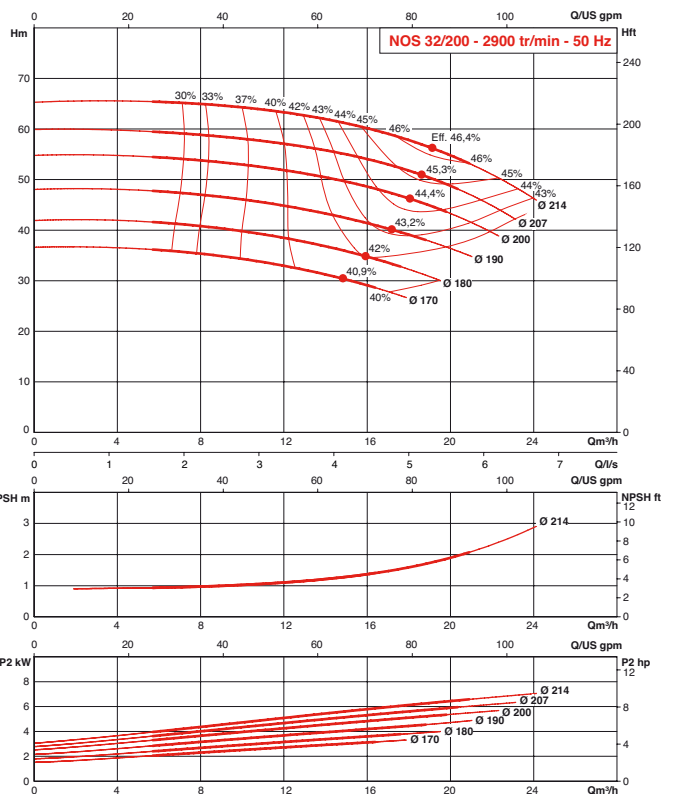
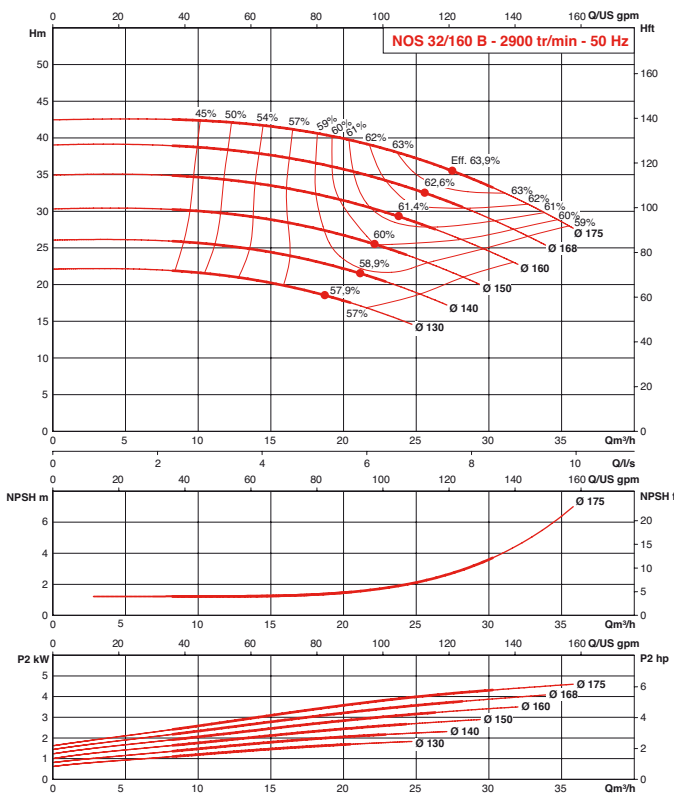
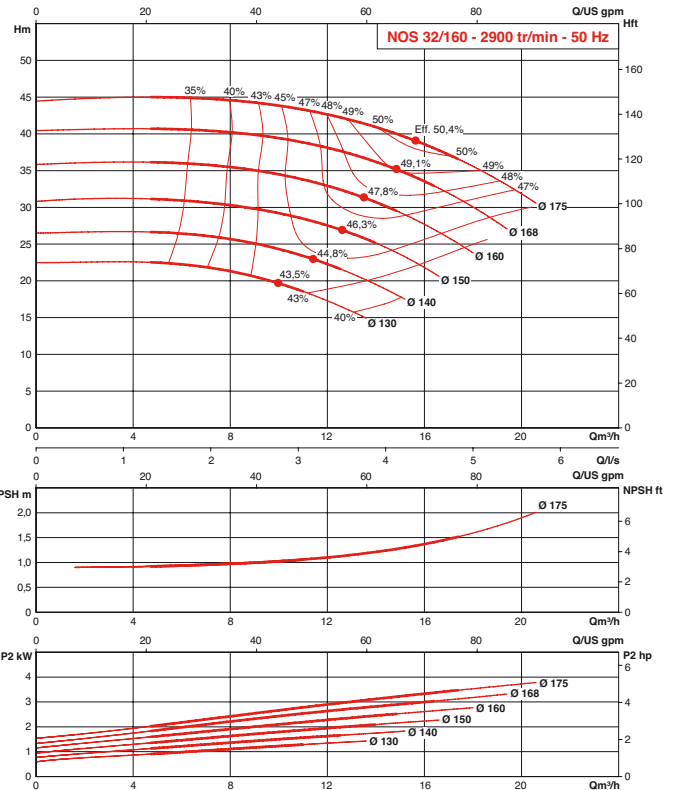
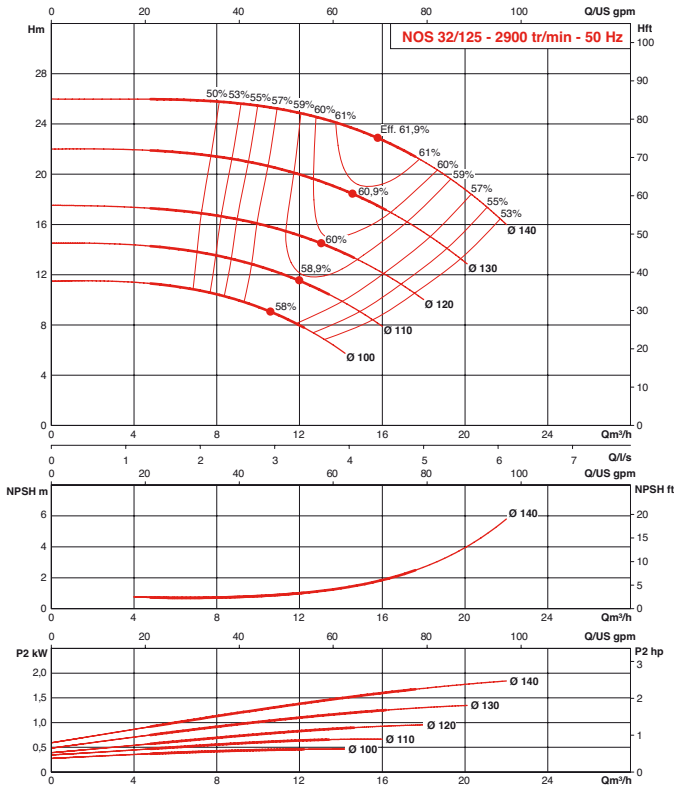



## PERFORMANCES HYDRAULIQUES

## 2900 TR/MIN

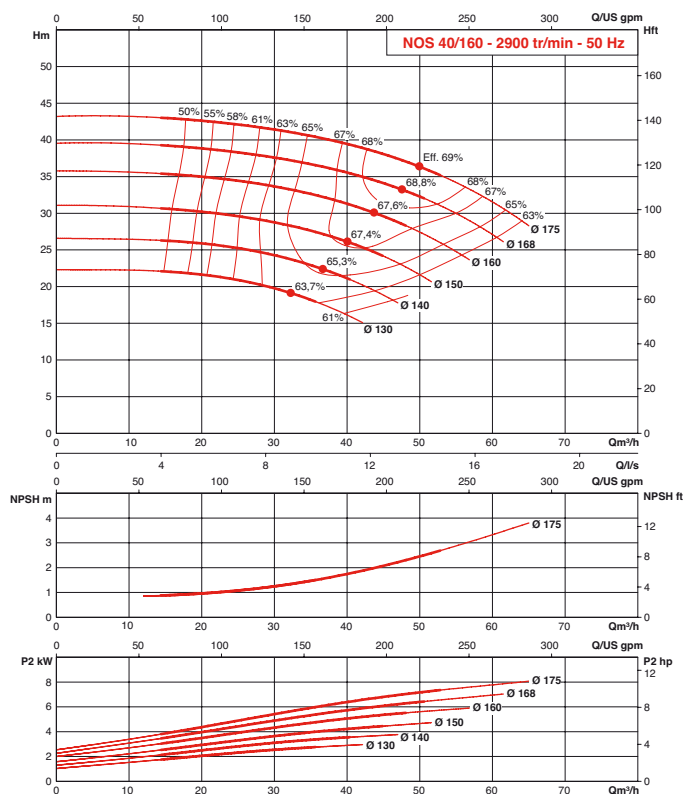
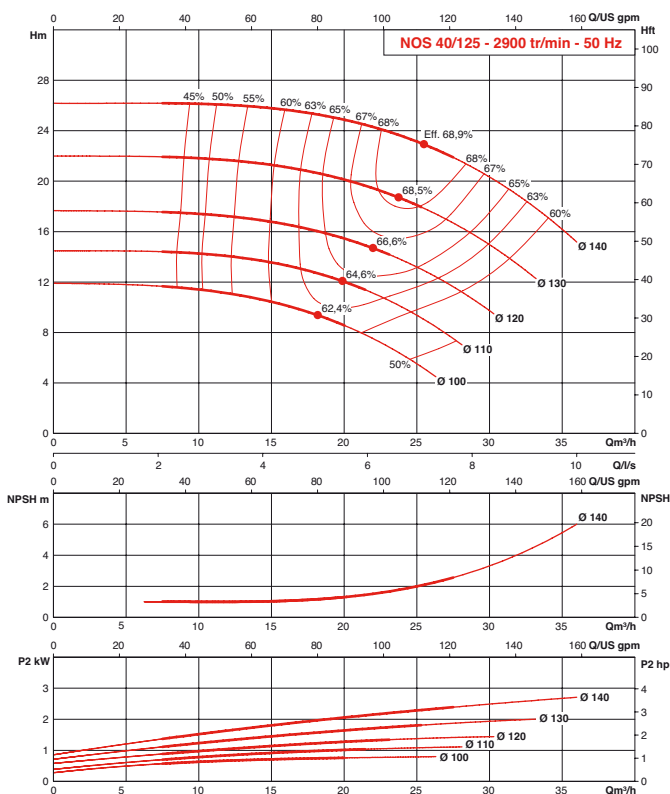
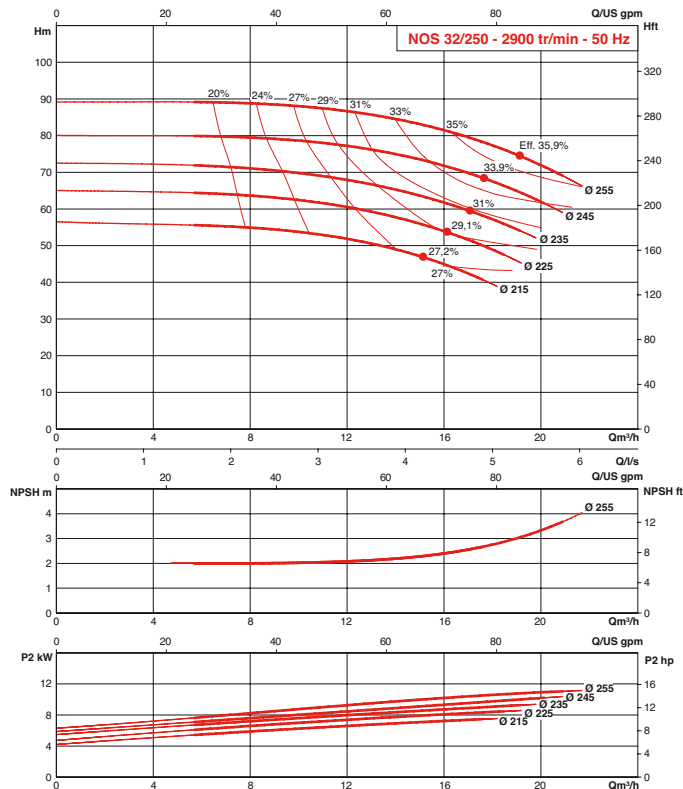
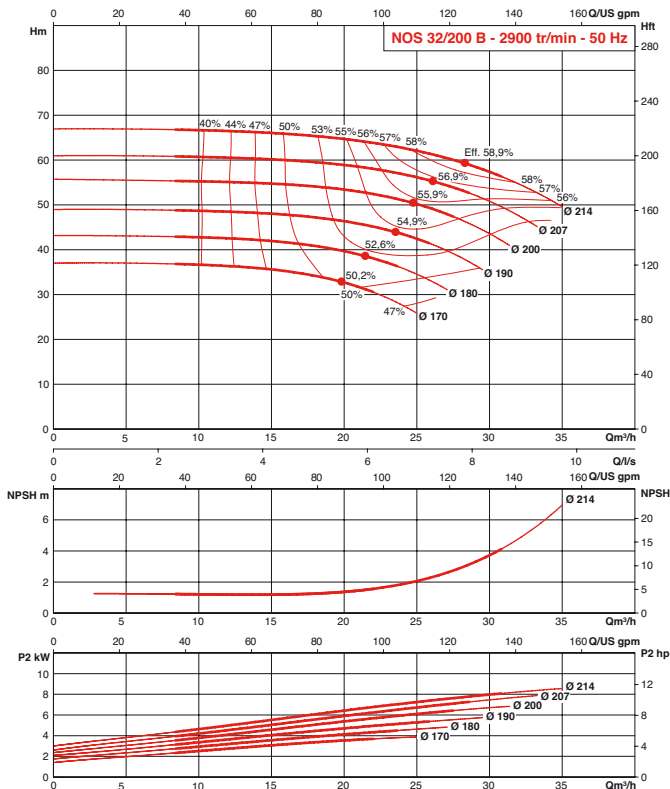

## PERFORMANCES HYDRAULIQUES

## 2900 TR/MIN

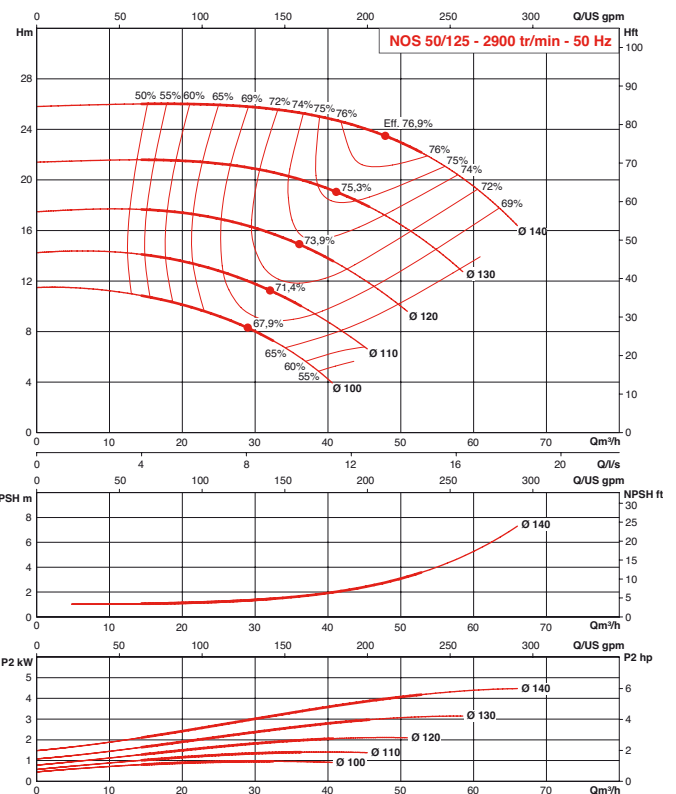
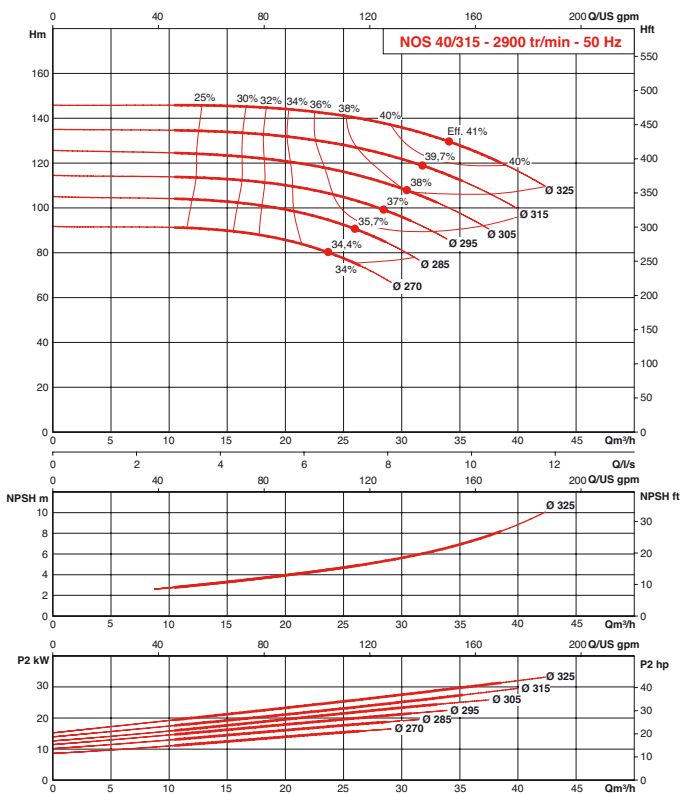
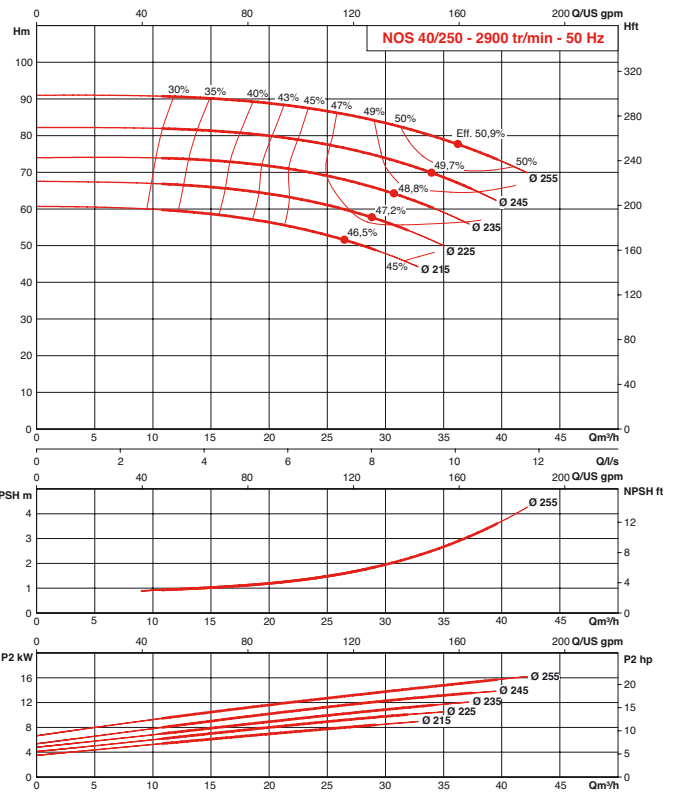
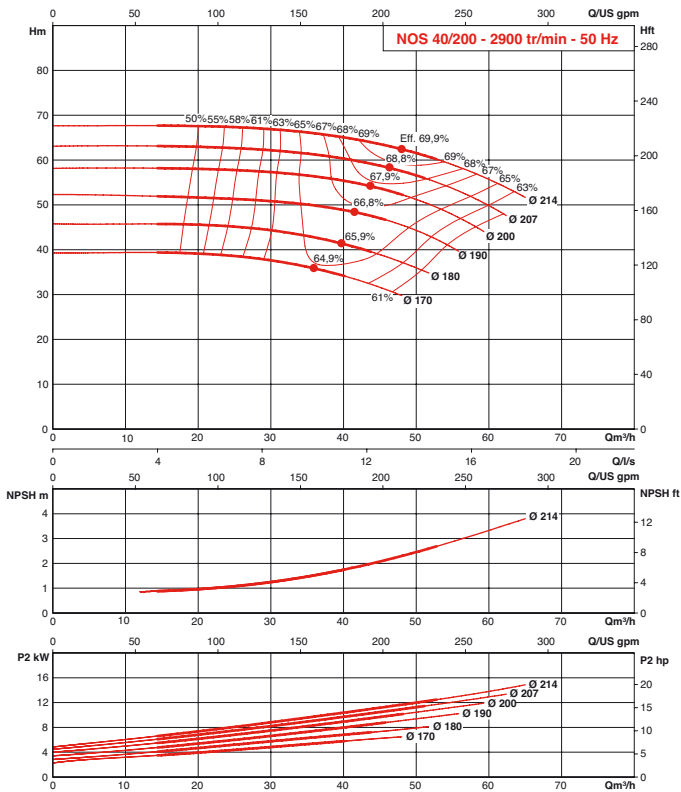

## PERFORMANCES HYDRAULIQUES

## 2900 TR/MIN

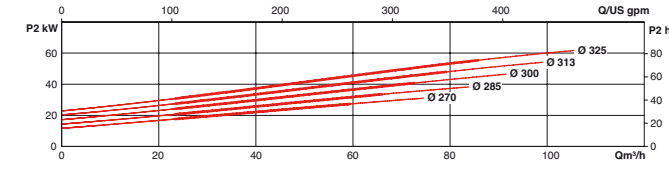
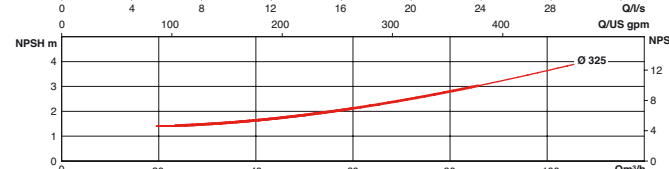
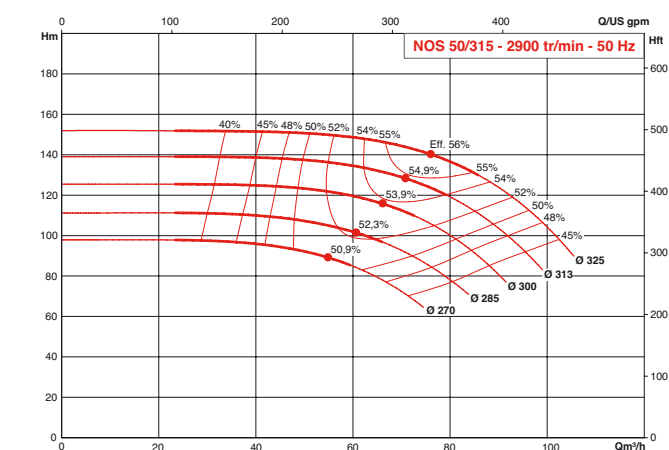
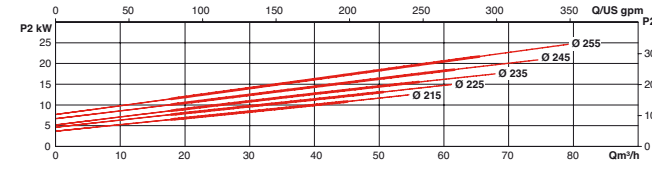
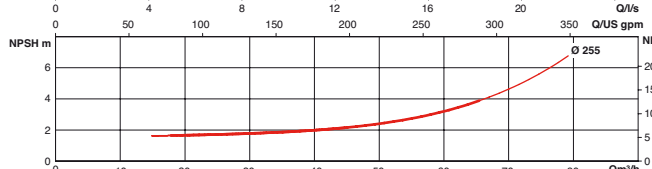
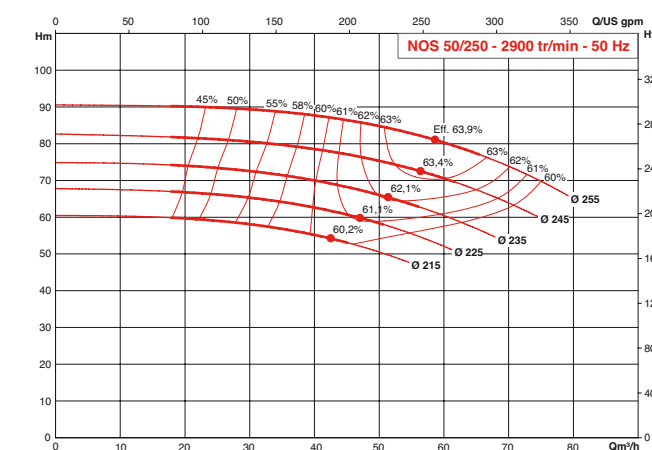
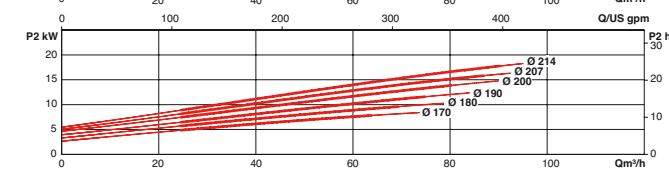
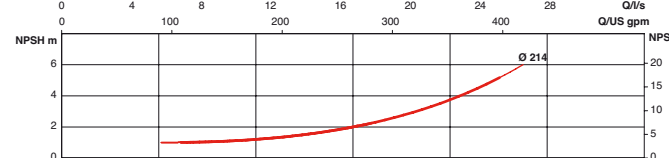
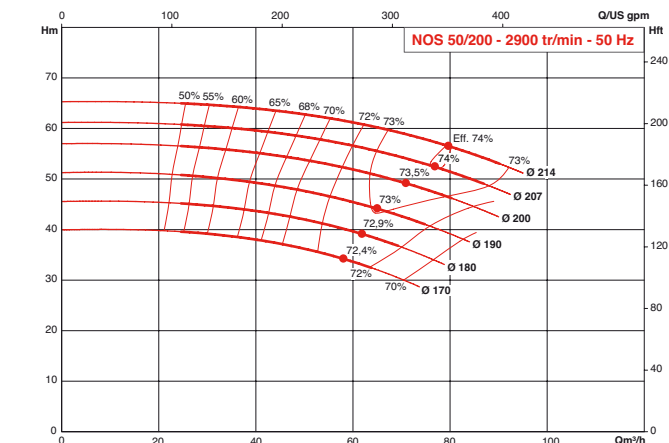
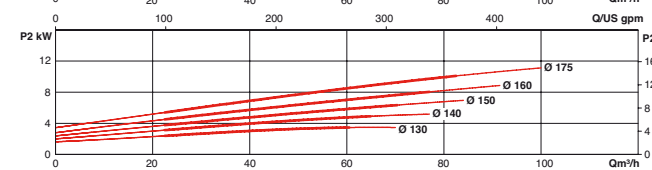
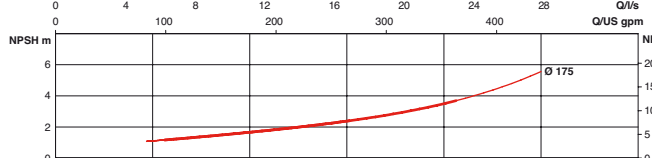
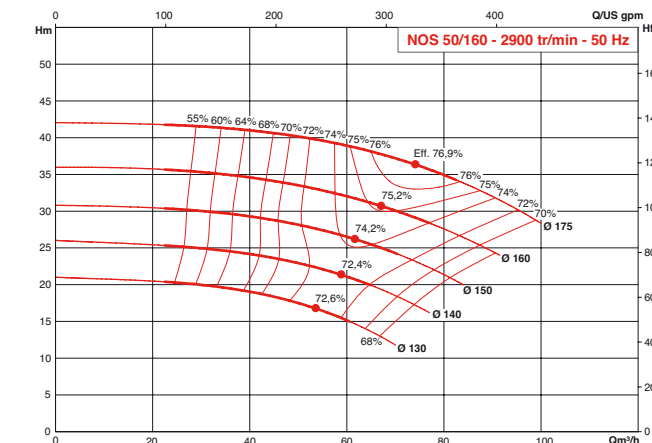

Génie climatique  
Pompes à rotor sec

## PERFORMANCES HYDRAULIQUES

2900 TR/MIN

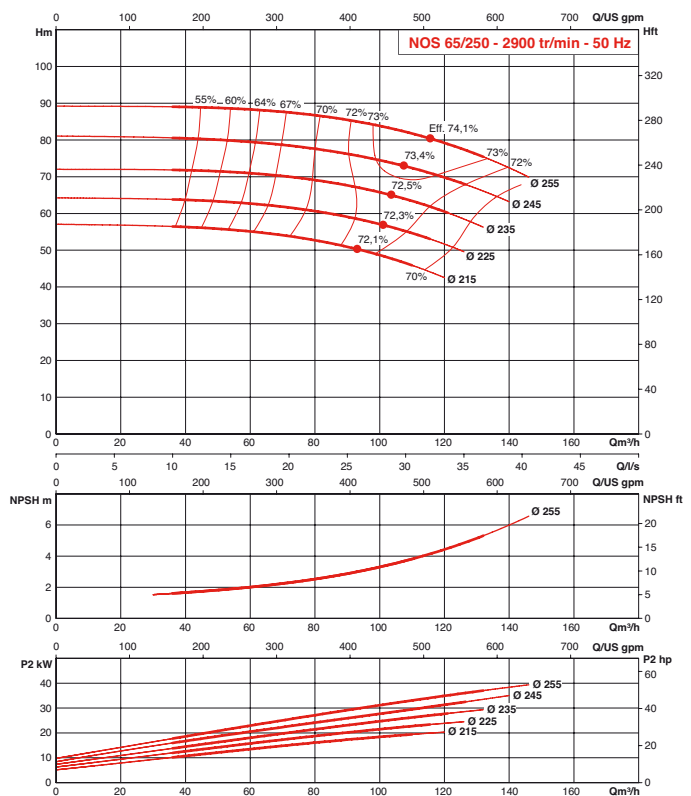
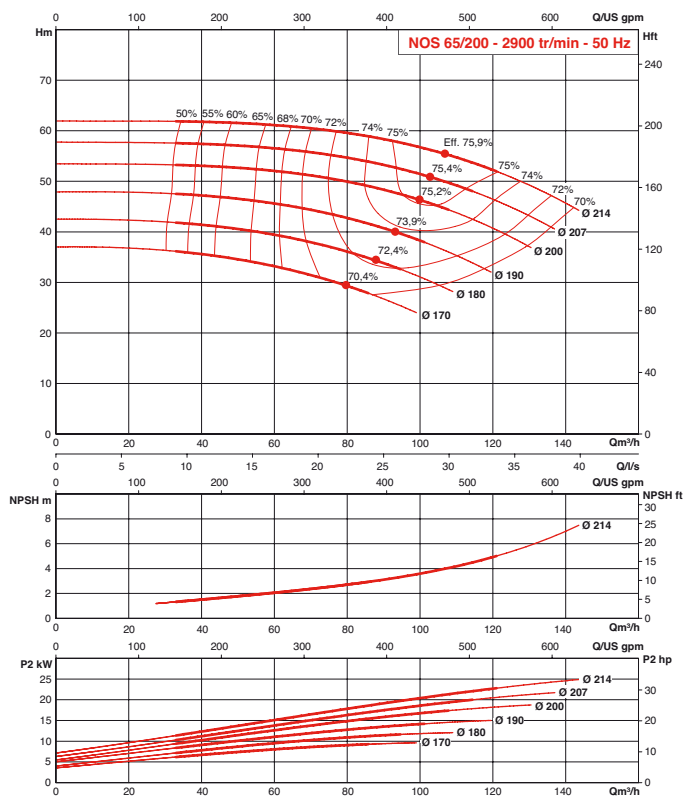
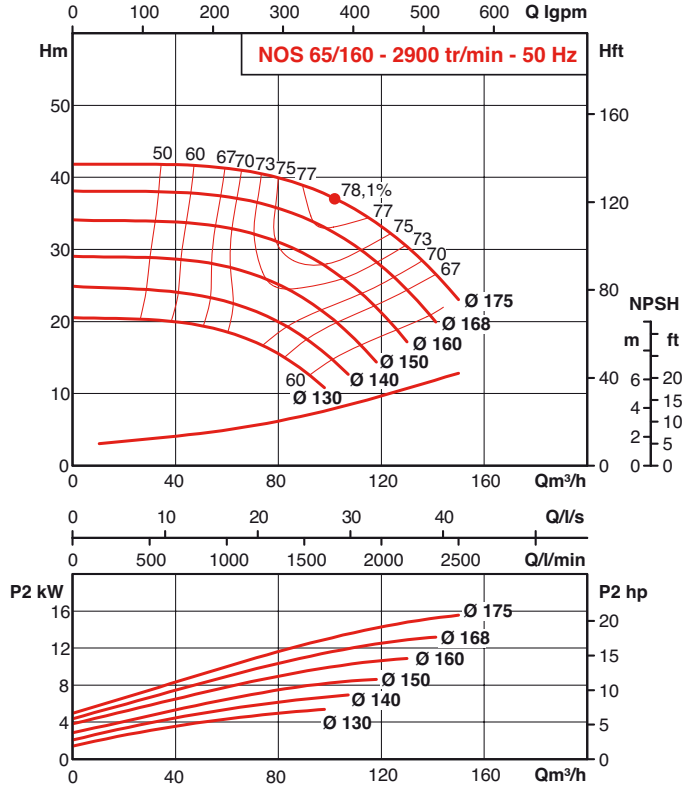
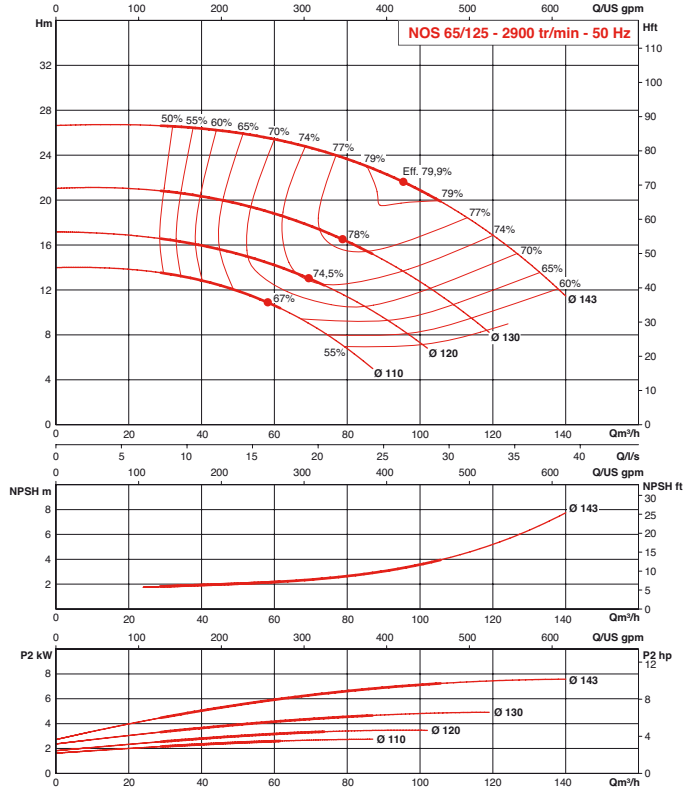

## PERFORMANCES HYDRAULIQUES

## 2900 TR/MIN

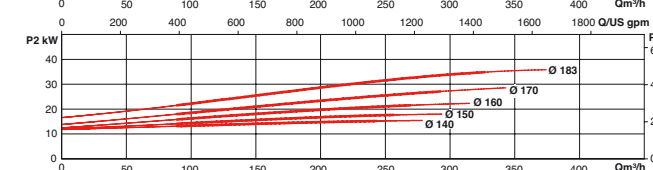
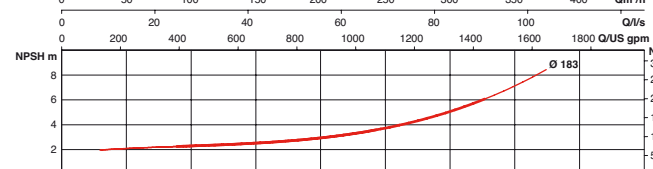
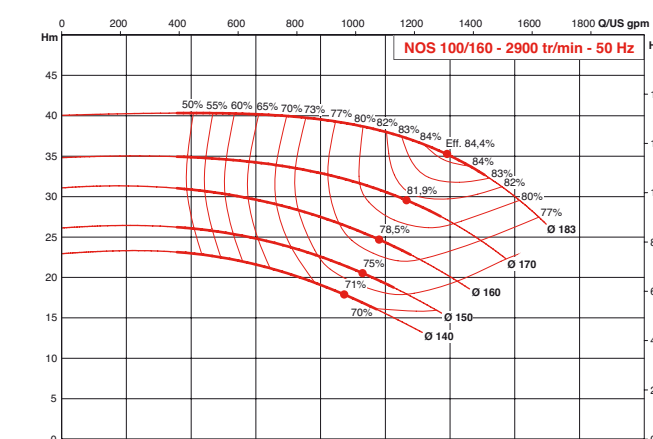
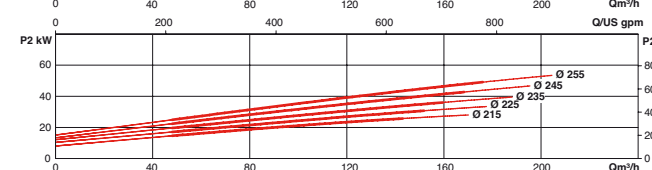
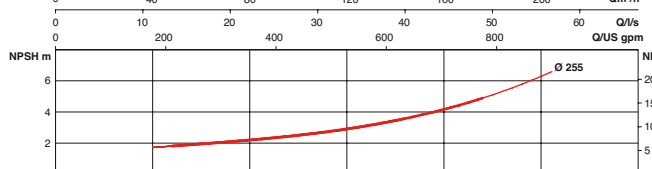
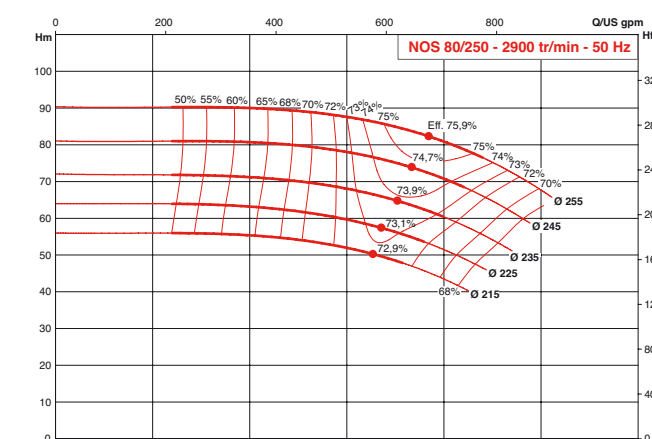
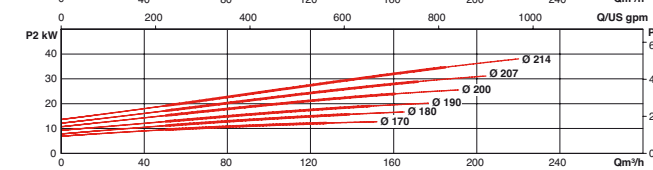
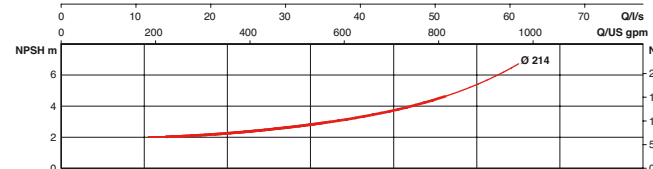
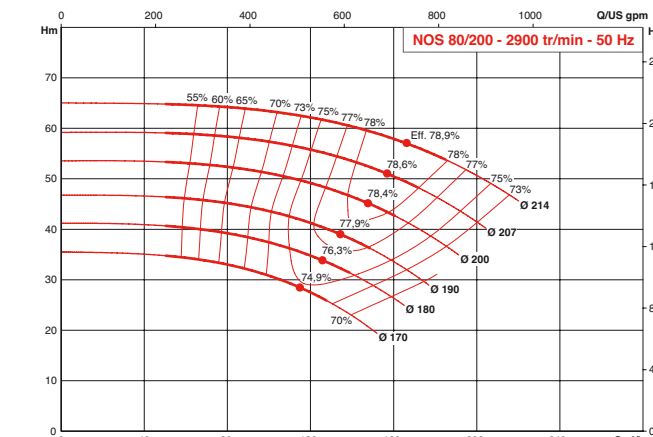
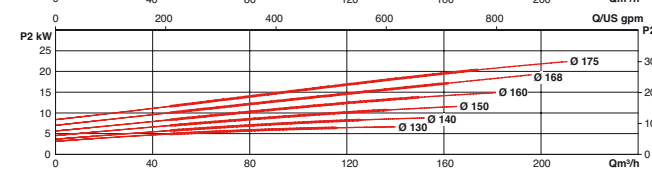
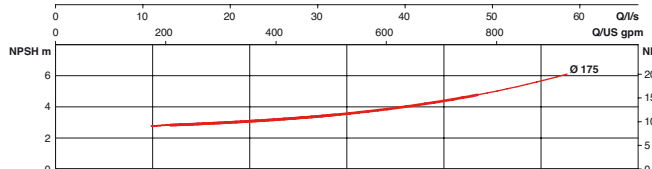
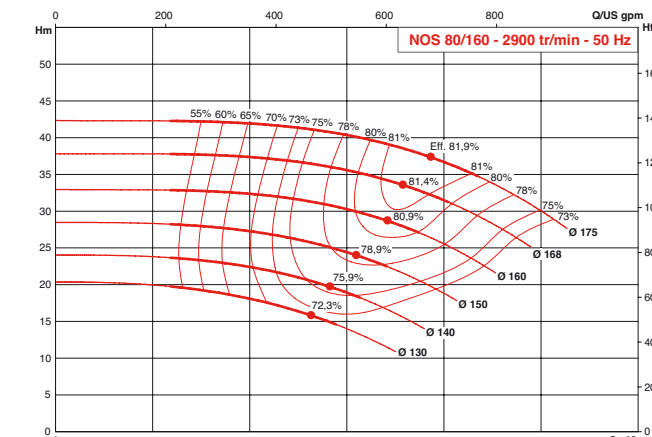

Génie climatique  
Pompes à rotor sec

## PERFORMANCES HYDRAULIQUES

## 2900 TR/MIN

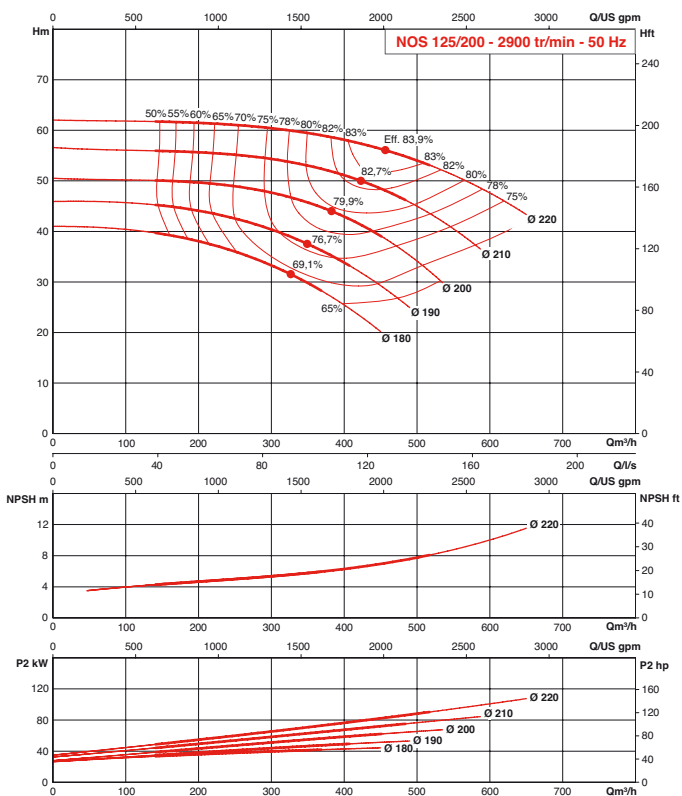
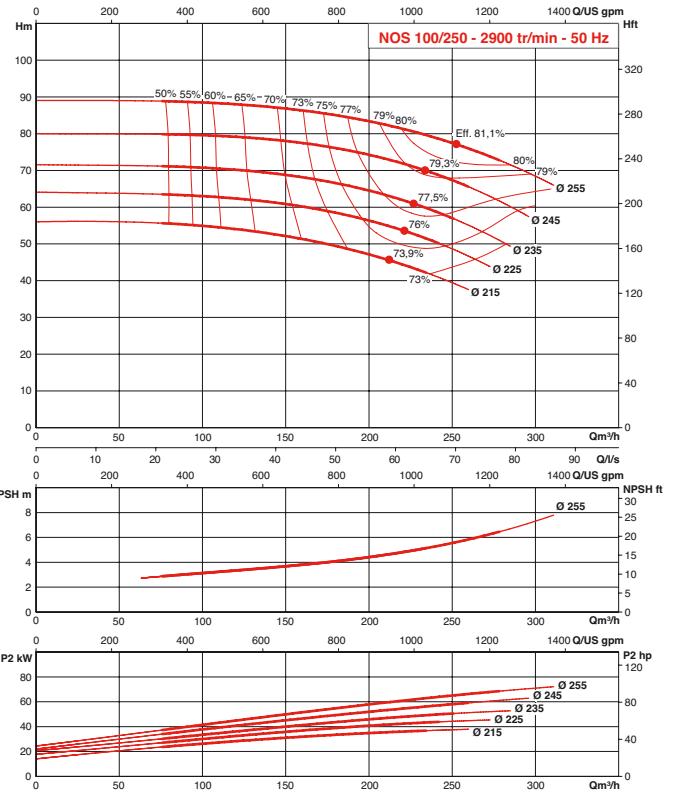
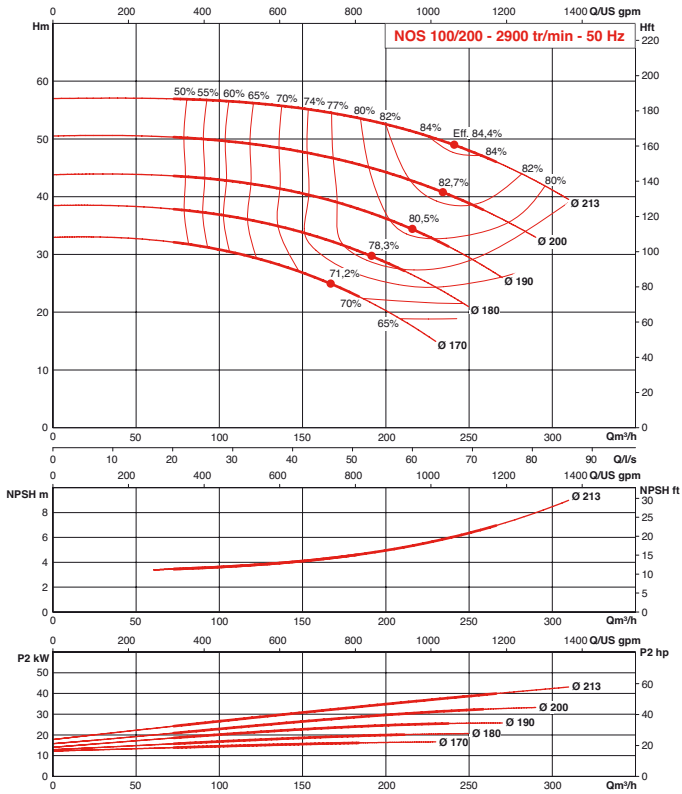

## DIMENSIONS – POMPE ARBRE NU – PALIER 25, 35, 45

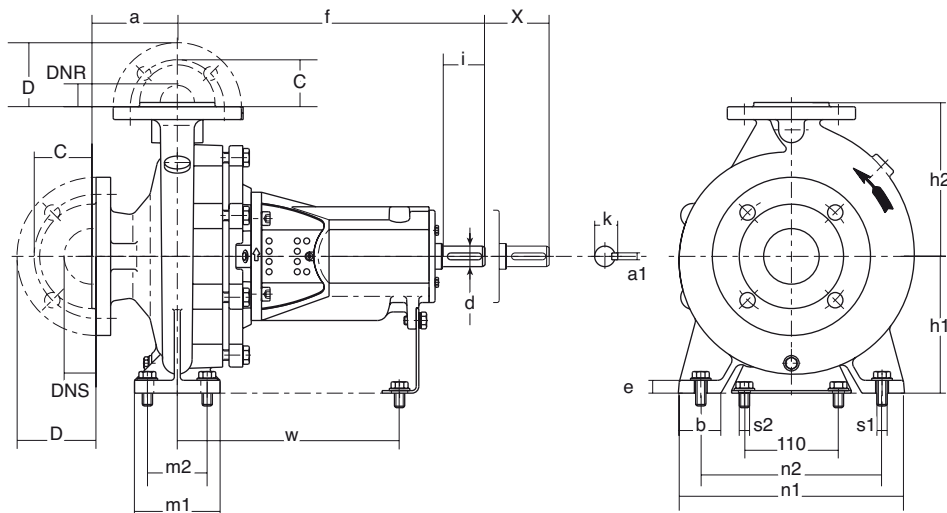

TYPE	Type de palier	Pmax à 20°C	Brides			X	m1	m2	h1	h2	n1	n2	s1	s2	b	e	w	a	f	i	d	a1	k	Masse Net
			bar	DNR	DNS																			
NOS32/125-08	25	16	32	50	16	100	100	70	112	140	190	140	M12	M12	50	15	260	80	360	50	24	8	27	31
NOS32/160-08	25	16	32	50	16	100	100	70	132	160	240	190	M12	M12	50	15	260	80	360	50	24	8	27	33
NOS32/160B-08	25	16	32	50	16	100	100	70	132	160	240	190	M12	M12	50	15	260	80	360	50	24	8	27	33
NOS32/200-08	25	16	32	50	16	100	100	70	160	180	240	190	M12	M12	50	15	260	80	360	50	24	8	27	34
NOS32/200B-08	25	16	32	50	16	100	100	70	160	180	240	190	M12	M12	50	15	260	80	360	50	24	8	27	34
NOS32/250-08	25	16	32	50	16	100	125	95	180	225	320	250	M12	M12	65	15	260	100	360	50	24	8	27	46
NOS40/125-08	25	16	40	65	16	100	100	70	112	140	210	160	M12	M12	50	15	260	80	360	50	24	8	27	28
NOS40/160-08	25	16	40	65	16	100	100	70	132	160	240	190	M12	M12	50	15	260	80	360	50	24	8	27	30
NOS40/200-08	25	16	40	65	16	100	100	70	160	180	265	212	M12	M12	50	15	260	100	360	50	24	8	27	36
NOS40/250-08	25	16	40	65	16	100	125	95	180	225	320	250	M12	M12	65	15	260	100	360	50	24	8	27	46
NOS40/315-08	35	16	40	65	16	100	125	95	225	250	345	280	M12	M12	65	18	340	125	470	80	32	10	35	73
NOS50/125-08	25	16	50	65	16	100	100	70	132	160	240	190	M12	M12	50	15	260	100	360	50	24	8	27	30
NOS50/160-08	25	16	50	65	16	100	100	70	160	180	265	212	M12	M12	50	15	260	100	360	50	24	8	27	36
NOS50/200-08	25	16	50	65	16	100	100	70	160	200	265	212	M12	M12	50	15	260	100	360	50	24	8	27	40
NOS50/250-08	25	16	50	65	16	100	125	95	180	225	320	250	M12	M12	65	15	260	100	360	50	24	8	27	50
NOS50/315-08	35	16	50	65	16	100	125	95	225	280	345	280	M12	M12	65	17	340	125	470	80	32	10	35	88
NOS65/125-08	25	16	65	80	16	100	125	95	160	180	280	212	M12	M12	65	15	260	100	360	50	24	8	27	33
NOS65/160-08	25	16	65	80	16	100	125	95	160	200	280	212	M12	M12	65	15	260	100	360	50	24	8	27	39
NOS65/200-08	25	16	65	80	16	100	125	95	180	225	320	250	M12	M12	65	15	260	100	360	50	24	8	27	45
NOS65/250-08	35	16	65	80	16	100	160	120	200	250	360	280	M16	M12	80	15	340	100	470	80	32	10	35	70
NOS65/315-08	35	16	65	80	16	100	160	120	225	280	400	315	M16	M12	80	18	340	125	470	80	32	10	35	92
NOS80/160-08	25	16	80	100	16	140	125	95	180	225	320	250	M12	M12	65	15	260	125	360	50	24	8	27	43
NOS80/200-08	35	16	80	100	16	140	125	95	180	250	345	280	M12	M12	65	15	340	125	470	80	32	10	35	60
NOS80/250-08	35	16	80	100	16	140	160	120	200	280	400	315	M16	M12	80	18	340	125	470	80	32	10	35	75
NOS80/315-08	35	16	80	100	16	140	160	120	250	315	400	315	M16	M12	80	18	340	125	470	80	32	10	35	95
NOS80/400-08	45	16	80	125	16	140	160	120	280	355	435	355	M16	M12	80	18	370	125	530	110	42	12	45	154
NOS100/160-08	35	16	100	125	16	140	160	120	200	280	360	280	M16	M12	80	18	340	125	470	80	32	10	35	78
NOS100/200-08	35	16	100	125	16	140	160	120	200	280	360	280	M16	M12	80	18	340	125	470	80	32	10	35	70
NOS100/250-08	35	16	100	125	16	140	160	120	225	280	400	315	M16	M12	80	18	340	140	470	80	32	10	35	85
NOS100/315-08	35	16	100	125	16	140	160	120	250	315	400	315	M16	M12	80	18	340	140	470	80	32	10	35	104
NOS100/400-08	45	16	100	125	16	140	200	150	280	355	500	400	M20	M12	100	18	370	140	530	110	42	12	45	166
NOS125/200-08	35	16	125	150	16	140	160	120	250	315	400	315	M16	M12	80	18	340	140	470	80	32	10	35	100
NOS125/250-08	35	16	125	150	16	140	160	120	250	355	400	315	M16	M12	80	18	340	140	470	80	32	10	35	102
NOS125/315-08	45	16	125	150	16	140	200	150	280	355	500	400	M20	M12	100	18	370	140	530	110	42	12	45	145
NOS125/400-08	45	16	125	150	16	140	200	150	315	400	500	400	M20	M12	100	18	370	140	530	110	42	12	45	177
NOS150/200-08	35	16	150	200	16	140	200	150	280	400	550	450	M20	M12	100	20	340	160	470	80	32	10	35	123
NOS150/250-08	35	16	150	200	16	140	200	150	280	400	500	400	M20	M12	100	20	340	160	470	80	32	10	35	128
NOS150/315-08	45	16	150	200	16	140	200	150	280	400	550	450	M20	M12	100	18	370	160	530	110	42	12	45	159
NOS150/400-08	45	16	150	200	16	140	200	150	315	450	550	450	M20	M12	100	18	370	160	530	110	42	12	45	207

## DIMENSIONS ET LOCALISATION – RACCORDS ACCESSOIRES – PALIER 25, 35, 45

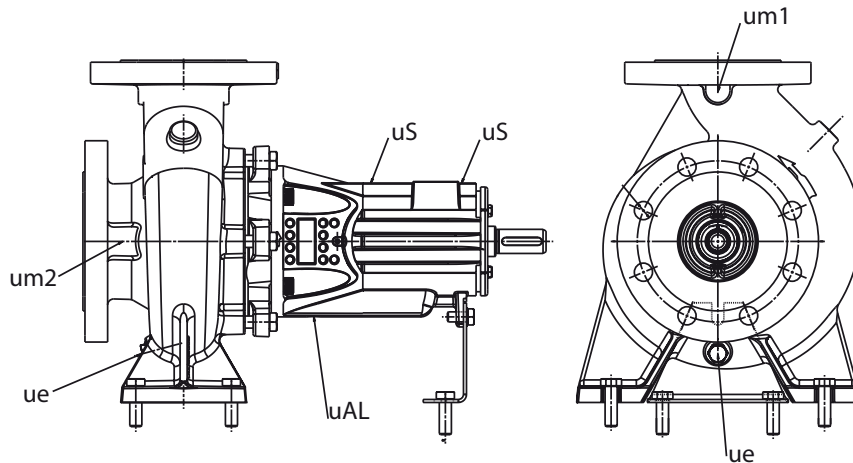

### Signification des codes

um1	Mesure de pression seulement sur demande
um2	Mesure de pression seulement sur demande
ue	Vidange
uAL	Récupération égouttures
us	Trou pour capteur

### Dimensions des raccords

Taille	um1	um2	ue	uAL	us
32/125 <sup>1)</sup>					
32/160					
32/200					
32/250					
40/125 <sup>1)</sup>					
40/160					
40/200					
40/250					
40/315					
50/125 <sup>1)</sup>					
50/160					
50/200					
50/250					
50/315					
65/125 <sup>1)</sup>					
65/160					
65/200					
65/250					
65/315	G1/4	G1/4		13	M8
80/160					
80/200					
80/250					
80/315					
80/400					
100/160					
100/200					
100/250					
100/315					
100/400					
125/200					
125/250					
125/315					
125/400					
150/200					
150/250					
150/315					
150/400					



## DIMENSIONS – GROUPES – 1450 MIN-1 AVEC SPACER

\*: Cotes liées au moteur, non contractuel

Récupérateur d'égoutures et 3ème point de fixation optionnels voir tableau

Brides aspiration-refoulement usinées suivant norme ISO 7005 voir encombrement pompe nue

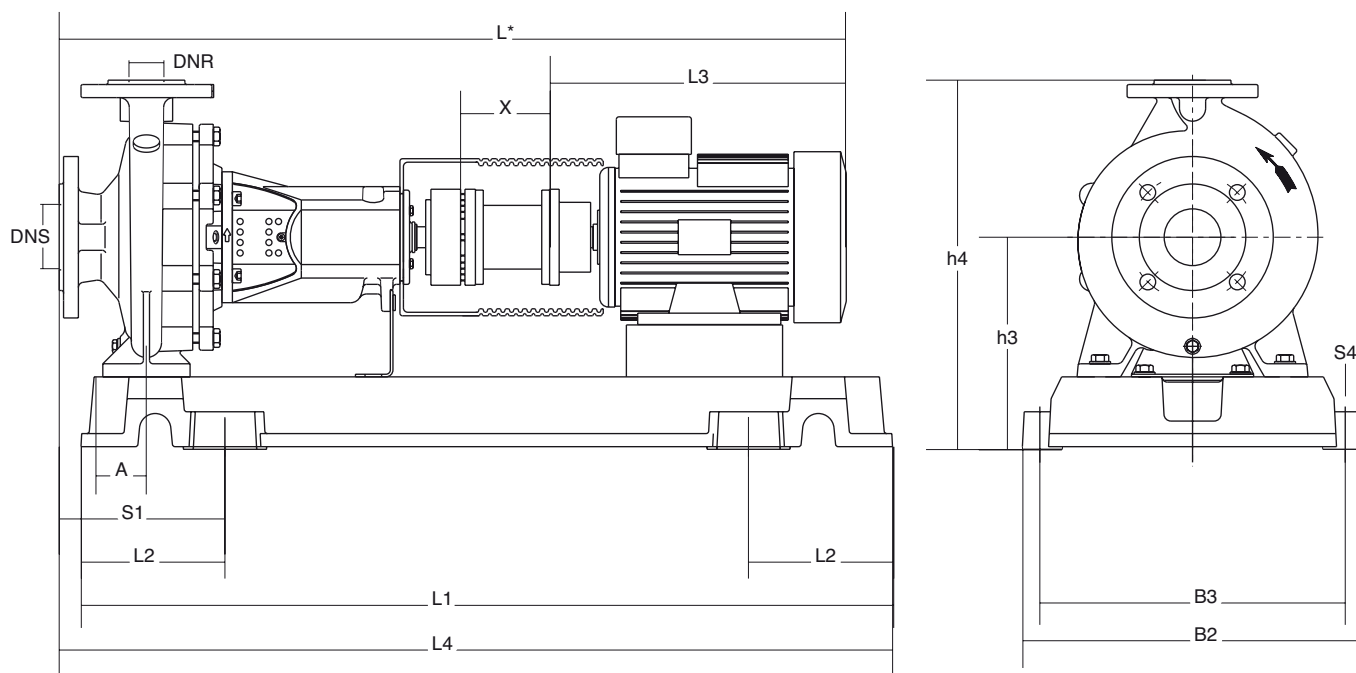

## DIMENSIONS – GROUPES – 1450 MIN-1 AVEC SPACER

TYPE	Type de carcasse	Kw	min-1	Socle	Type accept.	DNR	DNS	Tension	Groupe								Socle					Masse Net	
									A	L	L3	L4	h3	h4	S1	X	L1	L2	B2	B3	S4		
		kW						v	mm	mm	mm	mm	mm	mm	mm	mm	mm	mm	mm	mm	mm	mm	kg
NOS32/125-0.37-4-12	71	0,37	1450	N2	H80	32	50	3-230-400	60	792,5	252,5	835	195	335	150	100	830	145	360	320	19	85	
NOS32/160-0.37-4-12	71	0,37	1450	N2	H80	32	50	3-230-400	60	792,5	252,5	835	215	375	150	100	830	145	360	320	19	97	
NOS32/160-0.55-4-12	80	0,55	1450	N2	H80	32	50	3-230-400	60	823,5	283,5	835	215	375	150	100	830	145	360	320	19	90	
NOS32/160-0.75-4-12	80	0,75	1450	N2	H80	32	50	3-230-400	60	823,5	283,5	835	215	375	150	100	830	145	360	320	19	94	
NOS32/160B-0.37-4-12	71	0,37	1450	N2	H80	32	50	3-230-400	60	792,5	252,5	835	215	375	150	100	830	145	360	320	19	97	
NOS32/160B-0.55-4-12	80	0,55	1450	N2	H80	32	50	3-230-400	60	823,5	283,5	835	215	375	150	100	830	145	360	320	19	90	
NOS32/160B-0.75-4-12	80	0,75	1450	N2	H80	32	50	3-230-400	60	823,5	283,5	835	215	375	150	100	830	145	360	320	19	94	
NOS32/200-0.55-4-12	80	0,55	1450	N2	H80	32	50	3-230-400	60	823,5	283,5	835	243	423	150	100	830	145	360	320	19	93	
NOS32/200-0.75-4-12	80	0,75	1450	N2	H80	32	50	3-230-400	60	823,5	283,5	835	243	423	150	100	830	145	360	320	19	96	
NOS32/200-1.1-4-12	90S	1,1	1450	N3	H80	32	50	3-230-400	60	836,5	296,5	935	243	423	170	100	930	165	390	350	19	117	
NOS32/200-1.5-4-12	90L	1,5	1450	N3	H80	32	50	3-230-400	60	856,5	316,5	935	243	423	170	100	930	165	390	350	19	117	
NOS32/200B-0.55-4-12	80	0,55	1450	N2	H80	32	50	3-230-400	60	823,5	283,5	835	243	423	150	100	830	145	360	320	19	93	
NOS32/200B-0.75-4-12	80	0,75	1450	N2	H80	32	50	3-230-400	60	823,5	283,5	835	243	423	150	100	830	145	360	320	19	96	
NOS32/200B-1.1-4-12	90S	1,1	1450	N3	H80	32	50	3-230-400	60	836,5	296,5	935	243	423	170	100	930	165	390	350	19	117	
NOS32/200B-1.5-4-12	90L	1,5	1450	N3	H80	32	50	3-230-400	60	856,5	316,5	935	243	423	170	100	930	165	390	350	19	117	
NOS32/250-0.75-4-12	80	0,75	1450	N4	H80	32	50	3-230-400	72,5	843,5	283,5	1042,5	283	508	197,5	100	1030	185	450	400	24	141	
NOS32/250-1.1-4-12	90S	1,1	1450	N4	H80	32	50	3-230-400	72,5	856,5	296,5	1042,5	283	508	197,5	100	1030	185	450	400	24	146	
NOS32/250-1.5-4-12	90L	1,5	1450	N4	H80	32	50	3-230-400	72,5	876,5	316,5	1042,5	283	508	197,5	100	1030	185	450	400	24	146	
NOS32/250-2.2-4-12	100L	2,2	1450	N4	H80	32	50	3-230-400	72,5	912	352	1042,5	283	508	197,5	100	1030	185	450	400	24	152	

## DIMENSIONS – GROUPES – 1450 MIN-1 AVEC SPACER

TYPE	Type de carcasse	Kw	min-1	Socle	Type accept.	DNR	DNS	Tension	Groupe								Socle					Masse Net
									A	L	L3	L4	h3	h4	S1	X	L1	L2	B2	B3	S4	
									mm	mm	mm	mm	mm	mm	mm	mm	mm	mm	mm	mm	mm	
NOS40/125-0.37-4-12	71	0,37	1450	N2	H80	40	65	3-230-400	60	792,5	252,5	835	195	335	150	100	830	145	360	320	19	82
NOS40/125-0.55-4-12	80	0,55	1450	N2	H80	40	65	3-230-400	60	823,5	283,5	835	310	195	150	100	830	145	360	320	19	84
NOS40/160-0.37-4-12	71	0,37	1450	N2	H80	40	65	3-230-400	60	792,5	252,5	835	322	215	150	100	830	145	360	320	19	94
NOS40/160-0.55-4-12	80	0,55	1450	N2	H80	40	65	3-230-400	60	823,5	283,5	835	330	215	150	100	830	145	360	320	19	87
NOS40/160-0.75-4-12	80	0,75	1450	N2	H80	40	65	3-230-400	60	823,5	283,5	835	330	215	150	100	830	145	360	320	19	91
NOS40/160-1.1-4-12	90S	1,1	1450	N2	H80	40	65	3-230-400	60	836,5	296,5	835	347	215	150	100	830	145	360	320	19	96
NOS40/160-1.5-4-12	90L	1,5	1450	N3	H80	40	65	3-230-400	60	856,5	316,5	935	347	215	170	100	930	165	390	350	19	106
NOS40/200-0.55-4-12	80	0,55	1450	N3	H80	40	65	3-230-400	60	843,5	283,5	955	358	243	190	100	930	165	390	350	19	105
NOS40/200-0.75-4-12	80	0,75	1450	N3	H80	40	65	3-230-400	60	843,5	283,5	955	358	243	190	100	930	165	390	350	19	109
NOS40/200-1.1-4-12	90S	1,1	1450	N3	H80	40	65	3-230-400	60	856,5	296,5	955	375	243	190	100	930	165	390	350	19	119
NOS40/200-1.5-4-12	90L	1,5	1450	N3	H80	40	65	3-230-400	60	876,5	316,5	955	375	243	190	100	930	165	390	350	19	119
NOS40/200-2.2-4-12	100L	2,2	1450	N3	H80	40	65	3-230-400	60	912	352	955	384	243	190	100	930	165	390	350	19	125
NOS40/250-1.1-4-12	90S	1,1	1450	N4	H80	40	65	3-230-400	72,5	856,5	296,5	1042,5	415	283	197,5	100	1030	185	450	400	24	146
NOS40/250-1.5-4-12	90L	1,5	1450	N4	H80	40	65	3-230-400	72,5	876,5	316,5	1042,5	415	283	197,5	100	1030	185	450	400	24	146
NOS40/250-2.2-4-12	100L	2,2	1450	N4	H80	40	65	3-230-400	72,5	912	352	1042,5	424	283	197,5	100	1030	185	450	400	24	152
NOS40/250-3-4-12	100L	3	1450	N4	H80	40	65	3-230-400	72,5	912	352	1042,5	424	283	197,5	100	1030	185	450	400	24	153
NOS40/315-2.2-4-12	100L	2,2	1450	N5	H95	40	65	3-230-400	72,5	1047	352	1187,5	469	328	242,5	100	1150	205	490	440	24	217
NOS40/315-3-4-12	100L	3	1450	N5	H95	40	65	3-230-400	72,5	1047	352	1187,5	469	328	242,5	100	1150	205	490	440	24	218
NOS40/315-4-4-12	112M	4	1450	N5	H95	40	65	3-230-400	72,5	1090,5	395,5	1187,5	477	328	242,5	100	1150	205	490	440	24	227
NOS40/315-5.5-4-12	123S	5,5	1450	N5	H95	40	65	3-400	72,5	1135,5	440,5	1187,5	510	328	242,5	100	1150	205	490	440	24	248
NOS50/125-0.37-4-12	71	0,37	1450	N2	H80	50	65	3-230-400	60	812,5	252,5	855	322	215	170	100	830	145	360	320	19	94
NOS50/125-0.55-4-12	80	0,55	1450	N2	H80	50	65	3-230-400	60	843,5	283,5	855	330	215	170	100	830	145	360	320	19	87
NOS50/125-0.75-4-12	80	0,75	1450	N2	H80	50	65	3-230-400	60	843,5	283,5	855	330	215	170	100	830	145	360	320	19	91
NOS50/160-0.55-4-12	80	0,55	1450	N3	H80	50	65	3-230-400	60	843,5	283,5	955	358	243	190	100	930	165	390	350	19	105
NOS50/160-0.75-4-12	80	0,75	1450	N3	H80	50	65	3-230-400	60	843,5	283,5	955	358	243	190	100	930	165	390	350	19	109
NOS50/160-1.1-4-12	90S	1,1	1450	N3	H80	50	65	3-230-400	60	856,5	296,5	955	375	243	190	100	930	165	390	350	19	119
NOS50/160-1.5-4-12	90L	1,5	1450	N3	H80	50	65	3-230-400	60	876,5	316,5	955	375	243	190	100	930	165	390	350	19	119
NOS50/160-2.2-4-12	100L	2,2	1450	N3	H80	50	65	3-230-400	60	912	352	955	384	243	190	100	930	165	390	350	19	125
NOS50/200-1.1-4-12	90S	1,1	1450	N3	H80	50	65	3-230-400	60	856,5	296,5	955	375	243	190	100	930	165	390	350	19	123
NOS50/200-1.5-4-12	90L	1,5	1450	N3	H80	50	65	3-230-400	60	876,5	316,5	955	375	243	190	100	930	165	390	350	19	123
NOS50/200-2.2-4-12	100L	2,2	1450	N3	H80	50	65	3-230-400	60	912	352	955	384	243	190	100	930	165	390	350	19	129
NOS50/200-3-4-12	100L	3	1450	N3	H80	50	65	3-230-400	60	912	352	955	384	243	190	100	930	165	390	350	19	130
NOS50/250-1.5-4-12	90L	1,5	1450	N4	H80	50	65	3-230-400	72,5	876,5	316,5	1042,5	415	283	197,5	100	1030	185	450	400	24	150
NOS50/250-2.2-4-12	100L	2,2	1450	N4	H80	50	65	3-230-400	72,5	912	352	1042,5	424	283	197,5	100	1030	185	450	400	24	156
NOS50/250-3-4-12	100L	3	1450	N4	H80	50	65	3-230-400	72,5	912	352	1042,5	424	283	197,5	100	1030	185	450	400	24	157
NOS50/250-4-4-12	112M	4	1450	N4	H80	50	65	3-230-400	72,5	955,5	395,5	1042,5	432	283	197,5	100	1030	185	450	400	24	162
NOS50/315-4-4-12	112M	4	1450	N5	H95	50	65	3-230-400	72,5	1090,5	395,5	1187,5	477	328	242,5	100	1150	205	490	440	24	242
NOS50/315-5.5-4-12	123S	5,5	1450	N5	H95	50	65	3-400	72,5	1135,5	440,5	1187,5	510	328	242,5	100	1150	205	490	440	24	263
NOS50/315-7.5-4-12	132M	7,5	1450	N5	H95	50	65	3-400	72,5	1170,5	475,5	1187,5	510	328	242,5	100	1150	205	490	440	24	265
NOS50/315-9-4-12	132M	9	1450	N5	H95	50	65	3-400	72,5	1170,5	475,5	1187,5	510	328	242,5	100	1150	205	490	440	24	278
NOS65/125-0.55-4-12	80	0,55	1450	N3	H80	65	80	3-230-400	72,5	843,5	283,5	942,5	358	243	177,5	100	930	165	390	350	19	102
NOS65/125-0.75-4-12	80	0,75	1450	N3	H80	65	80	3-230-400	72,5	843,5	283,5	942,5	358	243	177,5	100	930	165	390	350	19	105
NOS65/125-1.1-4-12	90S	1,1	1450	N4	H80	65	80	3-230-400	72,5	856,5	296,5	1042,5	395	263	197,5	100	1030	185	450	400	24	128
NOS65/160-0.75-4-12	80	0,75	1450	N3	H80	65	80	3-230-400	72,5	843,5	283,5	942,5	358	243	177,5	100	930	165	390	350	19	112
NOS65/160-1.5-4-12	90L	1,5	1450	N3	H80	65	80	3-230-400	72,5	876,5	316,5	942,5	375	243	177,5	100	930	165	390	350	19	122
NOS65/160-2.2-4-12	100L	2,2	1450	N3	H80	65	80	3-230-400	72,5	912	352	942,5	384	243	177,5	100	930	165	390	350	19	128
NOS65/200-1.1-4-12	90S	1,1	1450	N4	H80	65	80	3-230-400	72,5	856,5	296,5	1042,5	415	283	197,5	100	1030	185	450	400	24	145
NOS65/200-1.5-4-12	90L	1,5	1450	N4	H80	65	80	3-230-400	72,5	876,5	316,5	1042,5	415	283	197,5	100	1030	185	450	400	24	145
NOS65/200-2.2-4-12	100L	2,2	1450	N4	H80	65	80	3-230-400	72,5	912	352	1042,5	424	283	197,5	100	1030	185	450	400	24	151

## DIMENSIONS – GROUPES – 1450 MIN-1 AVEC SPACER

TYPE	Type de carcassee	Kw	min-1	Socle	Type accept.	DNR	DNS	Tension	Groupe								Socle					Masse Net
									A	L	L3	L4	h3	h4	S1	X	L1	L2	B2	B3	S4	
									mm	mm	mm	mm	mm	mm	mm	mm	mm	mm	mm	mm	mm	
NOS65/200-3-4-12	100L	3	1450	N4	H80	65	80	3-230-400	72,5	912	352	1042,5	283	508	197,5	100	1030	185	450	400	24	152
NOS65/200-4-4-12	112M	4	1450	N4	H80	65	80	3-230-400	72,5	955,5	395,5	1042,5	283	508	197,5	100	1030	185	450	400	24	157
NOS65/250-2.2-4-12	100L	2,2	1450	N5	H95	65	80	3-230-400	90	1022	352	1145	303	553	200	100	1150	205	490	440	24	213
NOS65/250-3-4-12	100L	3	1450	N5	H95	65	80	3-230-400	90	1022	352	1145	303	553	200	100	1150	205	490	440	24	214
NOS65/250-4-4-12	112M	4	1450	N5	H95	65	80	3-230-400	90	1065,5	395,5	1145	303	553	200	100	1150	205	490	440	24	221
NOS65/250-5.5-4-12	123S	5,5	1450	N5	H95	65	80	3-400	90	1110,5	440,5	1145	303	553	200	100	1150	205	490	440	24	240
NOS65/315-5.5-4-12	123S	5,5	1450	N6	H95	65	80	3-400	90	1135,5	440,5	1305	328	608	240	100	1290	225	540	490	24	298
NOS65/315-7.5-4-12	132M	7,5	1450	N6	H95	65	80	3-400	90	1170,5	475,5	1305	328	608	240	100	1290	225	540	490	24	300
NOS65/315-9-4-12	132M	9	1450	N6	H95	65	80	3-400	90	1170,5	475,5	1305	328	608	240	100	1290	225	540	490	24	313
NOS65/315-11-4-12	160M	11	1450	N6	H95	65	80	3-400	90	1281	586	1305	328	608	240	100	1290	225	540	490	24	320
NOS65/315-15-4-12	160L	15	1450	N7	H110	65	80	3-400	90	1281	586	1455	328	608	265	100	1440	250	610	550	29	382
NOS80/160-1.1-4-12	90S	1,1	1450	N4	H80	80	100	3-230-400	72,5	921,5	296,5	1067,5	283	508	222,5	140	1030	185	450	400	24	143
NOS80/160-1.5-4-12	90L	1,5	1450	N4	H80	80	100	3-230-400	72,5	941,5	316,5	1067,5	283	508	222,5	140	1030	185	450	400	24	143
NOS80/160-2.2-4-12	100L	2,2	1450	N4	H80	80	100	3-230-400	72,5	977	352	1067,5	283	508	222,5	140	1030	185	450	400	24	149
NOS80/160-3-4-12	100L	3	1450	N4	H80	80	100	3-230-400	72,5	977	352	1067,5	283	508	222,5	140	1030	185	450	400	24	150
NOS80/160-4-4-12	112M	4	1450	N4	H80	80	100	3-230-400	72,5	1020,5	395,5	1067,5	283	508	222,5	140	1030	185	450	400	24	155
NOS80/200-1.5-4-12	90L	1,5	1450	N5	H95	80	100	3-230-400	72,5	1051,5	316,5	1187,5	283	533	242,5	140	1150	205	490	440	24	195
NOS80/200-2.2-4-12	100L	2,2	1450	N5	H95	80	100	3-230-400	72,5	1087	352	1187,5	283	533	242,5	140	1150	205	490	440	24	201
NOS80/200-3-4-12	100L	3	1450	N5	H95	80	100	3-230-400	72,5	1087	352	1187,5	283	533	242,5	140	1150	205	490	440	24	202
NOS80/200-4-4-12	112M	4	1450	N5	H95	80	100	3-230-400	72,5	1130,5	395,5	1187,5	283	533	242,5	140	1150	205	490	440	24	207
NOS80/200-5.5-4-12	123S	5,5	1450	N5	H95	80	100	3-400	72,5	1175,5	440,5	1187,5	283	533	242,5	140	1150	205	490	440	24	226
NOS80/250-3-4-12	100L	3	1450	N6	H95	80	100	3-230-400	90	1087	352	1305	303	583	240	140	1290	225	540	490	24	250
NOS80/250-4-4-12	112M	4	1450	N6	H95	80	100	3-230-400	90	1130,5	395,5	1305	303	583	240	140	1290	225	540	490	24	257
NOS80/250-5.5-4-12	123S	5,5	1450	N6	H95	80	100	3-400	90	1175,5	440,5	1305	303	583	240	140	1290	225	540	490	24	276
NOS80/250-7.5-4-12	132M	7,5	1450	N6	H95	80	100	3-400	90	1210,5	475,5	1305	303	583	240	140	1290	225	540	490	24	278
NOS80/315-5.5-4-12	123S	5,5	1450	N6	H95	80	100	3-400	90	1175,5	440,5	1305	353	668	240	140	1290	225	540	490	24	304
NOS80/315-7.5-4-12	132M	7,5	1450	N6	H95	80	100	3-400	90	1210,5	475,5	1305	353	668	240	140	1290	225	540	490	24	306
NOS80/315-9-4-12	132M	9	1450	N6	H95	80	100	3-400	90	1210,5	475,5	1305	353	668	240	140	1290	225	540	490	24	319
NOS80/315-11-4-12	160M	11	1450	N6	H95	80	100	3-400	90	1321	586	1305	353	668	240	140	1290	225	540	490	24	329
NOS80/315-15-4-12	160L	15	1450	N6	H110	80	100	3-400	90	1321	586	1305	353	668	240	140	1290	225	540	490	24	345
NOS80/400-11-4-12	160M	11	1450	N7	H95	80	125	3-400	90	1381	586	1455	383	738	265	140	1440	250	610	550	29	443
NOS80/400-15-4-12	160L	15	1450	N7	H110	80	125	3-400	90	1381	586	1455	383	738	265	140	1440	250	610	550	29	459
NOS80/400-18.5-4-12	180M	18,5	1450	N7	H110	80	125	3-400	90	1424	629	1455	383	738	265	140	1440	250	610	550	29	483
NOS80/400-22-4-12	180L	22	1450	N7	H125	80	125	3-400	90	1424	629	1455	383	738	265	140	1440	250	610	550	29	503
NOS80/400-30-4-12	200L	30	1450	N7	H125	80	125	3-400	90	1460	665	1455	383	738	265	140	1440	250	610	550	29	534
NOS100/160-2.2-4-12	100L	2,2	1450	N5	H95	100	125	3-230-400	90	1087	352	1170	303	583	225	140	1150	205	490	440	24	221
NOS100/160-3-4-12	100L	3	1450	N5	H95	100	125	3-230-400	90	1087	352	1170	303	583	225	140	1150	205	490	440	24	222
NOS100/160-4-4-12	112M	4	1450	N5	H95	100	125	3-230-400	90	1130,5	395,5	1170	303	583	225	140	1150	205	490	440	24	229
NOS100/160-5.5-4-12	123S	5,5	1450	N5	H95	100	125	3-400	90	1175,5	440,5	1170	303	583	225	140	1150	205	490	440	24	248
NOS100/200-2.2-4-12	100L	2,2	1450	N5	H95	100	125	3-230-400	90	1087	352	1170	303	583	225	140	1150	205	490	440	24	213
NOS100/200-3-4-12	100L	3	1450	N5	H95	100	125	3-230-400	90	1087	352	1170	303	583	225	140	1150	205	490	440	24	214
NOS100/200-4-4-12	112M	4	1450	N5	H95	100	125	3-230-400	90	1130,5	395,5	1170	303	583	225	140	1150	205	490	440	24	221
NOS100/200-5.5-4-12	123S	5,5	1450	N5	H95	100	125	3-400	90	1175,5	440,5	1170	303	583	225	140	1150	205	490	440	24	240
NOS100/200-7.5-4-12	132M	7,5	1450	N5	H95	100	125	3-400	90	1210,5	475,5	1170	303	583	225	140	1150	205	490	440	24	242
NOS100/250-4-4-12	112M	4	1450	N6	H95	100	125	3-230-400	90	1145,5	395,5	1320	328	608	255	140	1290	225	540	490	24	270
NOS100/250-5.5-4-12	123S	5,5	1450	N6	H95	100	125	3-400	90	1190,5	440,5	1320	328	608	255	140	1290	225	540	490	24	291
NOS100/250-7.5-4-12	132M	7,5	1450	N6	H95	100	125	3-400	90	1225,5	475,5	1320	328	608	255	140	1290	225	540	490	24	293
NOS100/250-9-4-12	132M	9	1450	N6	H95	100	125	3-400	90	1225,5	475,5	1320	328	608	255	140	1290	225	540	490	24	306
NOS100/250-11-4-12	160M	11	1450	N6	H95	100	125	3-400	90	1336	586	1320	328	608	255	140	1290	225	540	490	24	313

## DIMENSIONS – GROUPES – 1450 MIN-1 AVEC SPACER

TYPE	Type de carcasse	Kw	min-1	Socle	Type accept.	DNR	DNS	Tension	Groupe								Socle				Masse Net	
									A	L	L3	L4	h3	h4	S1	X	L1	L2	B2	B3		S4
									mm	mm	mm	mm	mm	mm	mm	mm	mm	mm	mm	mm		mm
NOS100/315-11-4-12	160M	11	1450	N6	H95	100	125	3-400	90	1336	586	1320	353	668	255	140	1290	225	540	490	24	339
NOS100/315-15-4-12	160L	15	1450	N6	H110	100	125	3-400	90	1336	586	1320	353	668	255	140	1290	225	540	490	24	354
NOS100/315-18.5-4-12	180M	18,5	1450	N7	H110	100	125	3-400	90	1379	629	1470	353	668	280	140	1440	250	610	550	29	424
NOS100/315-22-4-12	180L	22	1450	N7	H125	100	125	3-400	90	1379	629	1470	353	668	280	140	1440	250	610	550	29	444
NOS100/400-15-4-12	160L	15	1450	N8	H110	100	125	3-400	110	1396	586	1650	403	758	300	140	1640	290	660	600	29	511
NOS100/400-18.5-4-12	180M	18,5	1450	N8	H110	100	125	3-400	110	1439	629	1650	403	758	300	140	1640	290	660	600	29	535
NOS100/400-22-4-12	180L	22	1450	N8	H125	100	125	3-400	110	1439	629	1650	403	758	300	140	1640	290	660	600	29	555
NOS100/400-30-4-12	200L	30	1450	N8	H125	100	125	3-400	110	1475	665	1650	403	758	300	140	1640	290	660	600	29	587
NOS100/400-37-4-12	225S	37	1450	N8	H140	100	125	3-400	110	1575	765	1650	403	758	300	140	1640	290	660	600	29	643
NOS100/400-45-4-12	225M	45	1450	N8	H140	100	125	3-400	110	1575	765	1650	403	758	300	140	1640	290	660	600	29	677
NOS125/200-7.5-4-12	132M	7,5	1450	N6	H95	125	150	3-400	90	1225,5	475,5	1320	353	668	255	140	1290	225	540	490	24	311
NOS125/200-9-4-12	132M	9	1450	N6	H95	125	150	3-400	90	1225,5	475,5	1320	353	668	255	140	1290	225	540	490	24	324
NOS125/200-11-4-12	160M	11	1450	N6	H95	125	150	3-400	90	1336	586	1320	353	668	255	140	1290	225	540	490	24	334
NOS125/200-15-4-12	160L	15	1450	N6	H110	125	150	3-400	90	1336	586	1320	353	668	255	140	1290	225	540	490	24	350
NOS125/250-7.5-4-12	132M	7,5	1450	N6	H95	125	150	3-400	90	1225,5	475,5	1320	353	708	255	140	1290	225	540	490	24	313
NOS125/250-9-4-12	132M	9	1450	N6	H95	125	150	3-400	90	1225,5	475,5	1320	353	708	255	140	1290	225	540	490	24	326
NOS125/250-11-4-12	160M	11	1450	N6	H95	125	150	3-400	90	1336	586	1320	353	708	255	140	1290	225	540	490	24	336
NOS125/250-15-4-12	160L	15	1450	N7	H110	125	150	3-400	90	1336	586	1470	353	708	280	140	1440	250	610	550	29	398
NOS125/250-18.5-4-12	180M	18,5	1450	N7	H110	125	150	3-400	90	1379	629	1470	353	708	280	140	1440	250	610	550	29	422
NOS125/315-15-4-12	160L	15	1450	N8	H110	125	150	3-400	110	1396	586	1650	403	758	300	140	1640	290	660	600	29	489
NOS125/315-18.5-4-12	180M	18,5	1450	N8	H110	125	150	3-400	110	1439	629	1650	403	758	300	140	1640	290	660	600	29	514
NOS125/315-22-4-12	180L	22	1450	N8	H125	125	150	3-400	110	1439	629	1650	403	758	300	140	1640	290	660	600	29	534
NOS125/315-30-4-12	200L	30	1450	N8	H125	125	150	3-400	110	1475	665	1650	403	758	300	140	1640	290	660	600	29	565
NOS125/315-37-4-12	225S	37	1450	N8	H140	125	150	3-400	110	1575	765	1650	403	758	300	140	1640	290	660	600	29	622
NOS125/400-30-4-12	200L	30	1450	N8	H125	125	150	3-400	110	1475	665	1650	438	838	300	140	1640	290	660	600	29	609
NOS125/400-37-4-12	225S	37	1450	N8	H140	125	150	3-400	110	1575	765	1650	438	838	300	140	1640	290	660	600	29	665
NOS125/400-45-4-12	225M	45	1450	N8	H140	125	150	3-400	110	1575	765	1650	438	838	300	140	1640	290	660	600	29	699
NOS125/400-55-4-12	250M	55	1450	N8	H160	125	150	3-400	110	1594	784	1650	438	838	300	140	1640	290	660	600	29	731
NOS125/400-75-4-12	280S	75	1450	N9	H180	125	150	3-400	110	1881	1071	1850	438	838	330	140	1840	320	730	670	29	1182
NOS150/200-7.5-4-12	132M	7,5	1450	N9	H95	150	200	3-400	110	1245,5	475,5	1870	403	803	350	140	1840	320	730	670	29	519
NOS150/200-9-4-12	132M	9	1450	N9	H95	150	200	3-400	110	1245,5	475,5	1870	403	803	350	140	1840	320	730	670	29	531
NOS150/200-11-4-12	160M	11	1450	N9	H95	150	200	3-400	110	1356	586	1870	403	803	350	140	1840	320	730	670	29	545
NOS150/200-15-4-12	160L	15	1450	N9	H110	150	200	3-400	110	1356	586	1870	403	803	350	140	1840	320	730	670	29	561
NOS150/200-18.5-4-12	180M	18,5	1450	N9	H110	150	200	3-400	110	1399	629	1870	403	803	350	140	1840	320	730	670	29	585
NOS150/250-15-4-12	160L	15	1450	N8	H110	150	200	3-400	110	1356	586	1670	403	803	320	140	1640	290	660	600	29	472
NOS150/250-18.5-4-12	180M	18,5	1450	N8	H110	150	200	3-400	110	1399	629	1670	403	803	320	140	1640	290	660	600	29	496
NOS150/250-22-4-12	180L	22	1450	N8	H125	150	200	3-400	110	1399	629	1670	403	803	320	140	1640	290	660	600	29	516
NOS150/250-30-4-12	200L	30	1450	N8	H125	150	200	3-400	110	1435	665	1670	403	803	320	140	1640	290	660	600	29	548
NOS150/315-22-4-12	180L	22	1450	N9	H125	150	200	3-400	110	1459	629	1870	403	803	350	140	1840	320	730	670	29	642
NOS150/315-30-4-12	200L	30	1450	N9	H125	150	200	3-400	110	1495	665	1870	403	803	350	140	1840	320	730	670	29	673
NOS150/315-37-4-12	225S	37	1450	N9	H140	150	200	3-400	110	1595	765	1870	403	803	350	140	1840	320	730	670	29	730
NOS150/315-45-4-12	225M	45	1450	N9	H140	150	200	3-400	110	1595	765	1870	403	803	350	140	1840	320	730	670	29	764
NOS150/315-55-4-12	250M	55	1450	N9	H160	150	200	3-400	110	1614	784	1870	403	803	350	140	1840	320	730	670	29	796
NOS150/400-45-4-12	225M	45	1450	N9	H140	150	200	3-400	110	1595	765	1870	438	888	350	140	1840	320	730	670	29	824
NOS150/400-55-4-12	250M	55	1450	N9	H160	150	200	3-400	110	1614	784	1870	438	888	350	140	1840	320	730	670	29	855
NOS150/400-75-4-12	280S	75	1450	N9	H180	150	200	3-400	110	1901	1071	1870	438	888	350	140	1840	320	730	670	29	1213
NOS150/400-90-4-12	280M	90	1450	N9	H180	150	200	3-400	110	1901	1071	1870	438	888	350	140	1840	320	730	670	29	1248

## DIMENSIONS – BRIDES

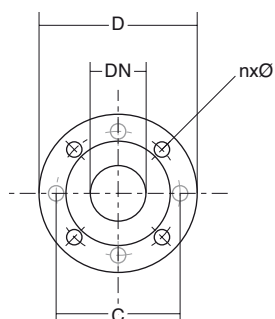

Raccordements des brides DIN 2501 PN 16

DN	32	40	50	65	80	100	125	150	200
<b>D</b>	140	150	165	185	200	220	250	285	340
<b>C</b>	100	110	125	145	160	180	210	240	295
<b>nxØ</b>	4x18	4x18	4x18	4x18	8x18	8x18	8x18	8x22	12x22

## DIMENSIONS – GROUPES – 1450 MIN-1 SANS SPACER

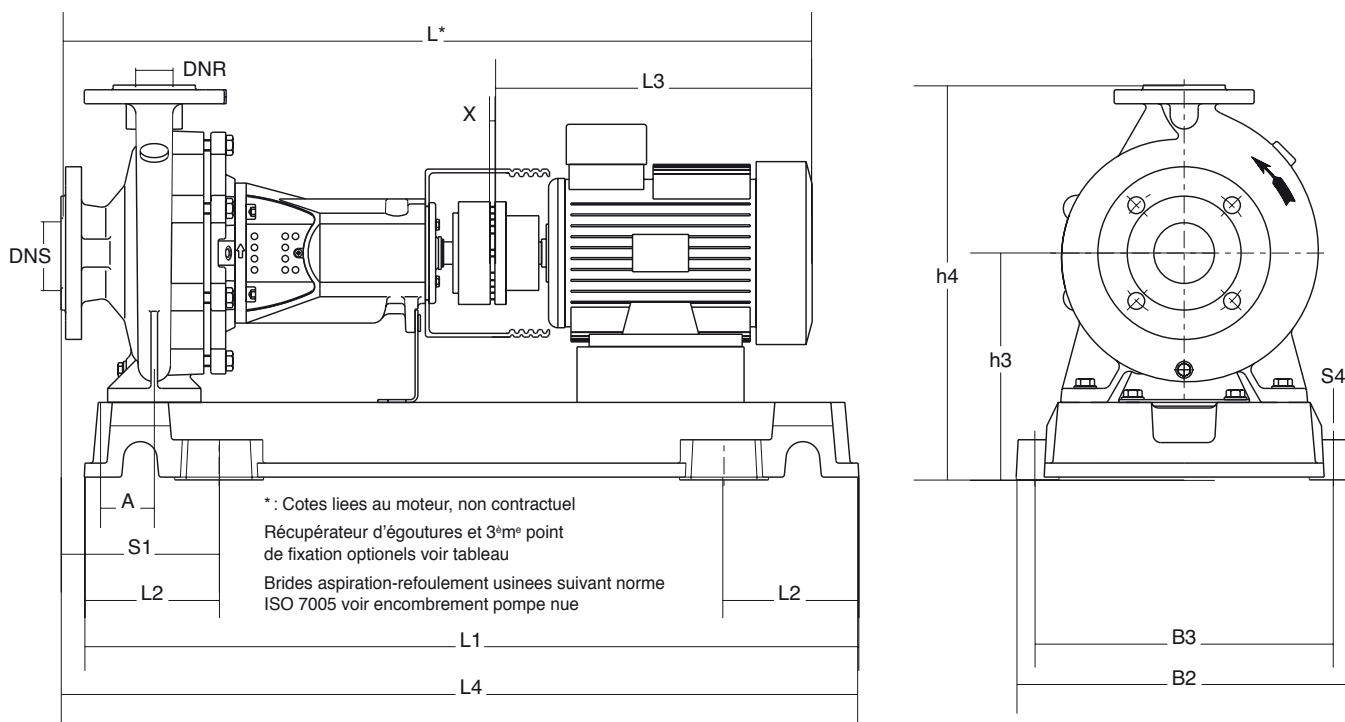

## DIMENSIONS – GROUPES – 1450 MIN-1 SANS SPACER

TYPE	Type de carcassee	Kw	min-1	Socle	Type acpt.	DNR	DNS	Tension	Groupe							Socle					Masse Net		
									A	L	L3	L4	h3	h4	S1	X	L1	L2	B2	B3		S4	
		kW						V	mm	mm	mm	mm	mm	mm	mm	mm	mm	mm	mm	mm	mm	mm	kg
NOS32/125-0.37-4-05	71	0,37	1450	N2	B68	32	50	3-230-400	60	695,5	252,5	835	195	335	150	3	830	145	360	320	19	83	
NOS32/160-0.37-4-05	71	0,37	1450	N2	B68	32	50	3-230-400	60	695,5	252,5	835	215	375	150	3	830	145	360	320	19	95	
NOS32/160-0.55-4-05	80	0,55	1450	N2	B68	32	50	3-230-400	60	726,5	283,5	835	215	375	150	3	830	145	360	320	19	88	
NOS32/160-0.75-4-05	80	0,75	1450	N2	B68	32	50	3-230-400	60	726,5	283,5	835	215	375	150	3	830	145	360	320	19	92	
NOS32/160B-0.37-4-05	71	0,37	1450	N2	B68	32	50	3-230-400	60	695,5	252,5	835	215	375	150	3	830	145	360	320	19	95	
NOS32/160B-0.55-4-05	80	0,55	1450	N2	B68	32	50	3-230-400	60	726,5	283,5	835	215	375	150	3	830	145	360	320	19	88	
NOS32/160B-0.75-4-05	80	0,75	1450	N2	B68	32	50	3-230-400	60	726,5	283,5	835	215	375	150	3	830	145	360	320	19	92	
NOS32/200-0.55-4-05	80	0,55	1450	N2	B68	32	50	3-230-400	60	726,5	283,5	835	243	423	150	3	830	145	360	320	19	90	
NOS32/200-0.75-4-05	80	0,75	1450	N2	B68	32	50	3-230-400	60	726,5	283,5	835	243	423	150	3	830	145	360	320	19	94	
NOS32/200-1.1-4-05	90S	1,1	1450	N2	B68	32	50	3-230-400	60	739,5	296,5	835	243	423	150	3	830	145	360	320	19	104	
NOS32/200-1.5-4-05	90L	1,5	1450	N2	B68	32	50	3-230-400	60	759,5	316,5	835	243	423	150	3	830	145	360	320	19	105	
NOS32/200B-0.55-4-05	80	0,55	1450	N2	B68	32	50	3-230-400	60	726,5	283,5	835	243	423	150	3	830	145	360	320	19	90	
NOS32/200B-0.75-4-05	80	0,75	1450	N2	B68	32	50	3-230-400	60	726,5	283,5	835	243	423	150	3	830	145	360	320	19	94	
NOS32/200B-1.1-4-05	90S	1,1	1450	N2	B68	32	50	3-230-400	60	739,5	296,5	835	243	423	150	3	830	145	360	320	19	104	
NOS32/200B-1.5-4-05	90L	1,5	1450	N2	B68	32	50	3-230-400	60	759,5	316,5	835	243	423	150	3	830	145	360	320	19	105	
NOS32/250-0.75-4-05	80	0,75	1450	N4	B68	32	50	3-230-400	72,5	746,5	283,5	1042,5	283	508	197,5	3	1030	185	450	400	24	139	
NOS32/250-1.1-4-05	90S	1,1	1450	N4	B68	32	50	3-230-400	72,5	759,5	296,5	1042,5	283	508	197,5	3	1030	185	450	400	24	144	
NOS32/250-1.5-4-05	90L	1,5	1450	N4	B68	32	50	3-230-400	72,5	779,5	316,5	1042,5	283	508	197,5	3	1030	185	450	400	24	144	
NOS32/250-2.2-4-05	100L	2,2	1450	N4	B80	32	50	3-230-400	72,5	815	352	1042,5	283	508	197,5	3	1030	185	450	400	24	151	
NOS40/125-0.37-4-05	71	0,37	1450	N2	B68	40	65	3-230-400	60	695,5	252,5	835	195	335	150	3	830	145	360	320	19	80	
NOS40/125-0.55-4-05	80	0,55	1450	N2	B68	40	65	3-230-400	60	726,5	283,5	835	195	335	150	3	830	145	360	320	19	82	
NOS40/160-0.37-4-05	71	0,37	1450	N2	B68	40	65	3-230-400	60	695,5	252,5	835	215	375	150	3	830	145	360	320	19	92	
NOS40/160-0.55-4-05	80	0,55	1450	N2	B68	40	65	3-230-400	60	726,5	283,5	835	215	375	150	3	830	145	360	320	19	85	

## DIMENSIONS – GROUPES – 1450 MIN-1 SANS SPACER

TYPE	Type de carcasse	Kw	min-1	Socle	Type accpt.	DNR	DNS	Tension	Groupe								Socle					Masse Net
									A	L	L3	L4	h3	h4	S1	X	L1	L2	B2	B3	S4	
									mm	mm	mm	mm	mm	mm	mm	mm	mm	mm	mm	mm	mm	
NOS40/160-0.75-4-05	80	0,75	1450	N2	B68	40	65	3-230-400	60	726,5	283,5	835	215	375	150	3	830	145	360	320	19	89
NOS40/160-1.1-4-05	90S	1,1	1450	N2	B68	40	65	3-230-400	60	739,5	296,5	835	215	375	150	3	830	145	360	320	19	93
NOS40/160-1.5-4-05	90L	1,5	1450	N2	B68	40	65	3-230-400	60	759,5	316,5	835	215	375	150	3	830	145	360	320	19	94
NOS40/200-0.55-4-05	80	0,55	1450	N3	B68	40	65	3-230-400	60	746,5	283,5	955	243	423	190	3	930	165	390	350	19	103
NOS40/200-0.75-4-05	80	0,75	1450	N3	B68	40	65	3-230-400	60	746,5	283,5	955	243	423	190	3	930	165	390	350	19	106
NOS40/200-1.1-4-05	90S	1,1	1450	N3	B68	40	65	3-230-400	60	759,5	296,5	955	243	423	190	3	930	165	390	350	19	116
NOS40/200-1.5-4-05	90L	1,5	1450	N3	B68	40	65	3-230-400	60	779,5	316,5	955	243	423	190	3	930	165	390	350	19	117
NOS40/200-2.2-4-05	100L	2,2	1450	N3	B80	40	65	3-230-400	60	815	352	955	243	423	190	3	930	165	390	350	19	124
NOS40/250-1.1-4-05	90S	1,1	1450	N4	B68	40	65	3-230-400	72,5	759,5	296,5	1042,5	283	508	197,5	3	1030	185	450	400	24	144
NOS40/250-1.5-4-05	90L	1,5	1450	N4	B68	40	65	3-230-400	72,5	779,5	316,5	1042,5	283	508	197,5	3	1030	185	450	400	24	144
NOS40/250-2.2-4-05	100L	2,2	1450	N4	B80	40	65	3-230-400	72,5	815	352	1042,5	283	508	197,5	3	1030	185	450	400	24	151
NOS40/250-3-4-05	100L	3	1450	N4	B80	40	65	3-230-400	72,5	815	352	1042,5	283	508	197,5	3	1030	185	450	400	24	152
NOS40/160-2.2-4-05	100L	2,2	1450	N5	B95	40	65	3-230-400	72,5	950	352	1187,5	328	578	242,5	3	1150	205	490	440	24	216
NOS40/315-3-4-05	100L	3	1450	N5	B95	40	65	3-230-400	72,5	950	352	1187,5	328	578	242,5	3	1150	205	490	440	24	217
NOS40/315-4-4-05	112M	4	1450	N5	B95	40	65	3-230-400	72,5	993,5	395,5	1187,5	328	578	242,5	3	1150	205	490	440	24	226
NOS40/315-5.5-4-05	123S	5,5	1450	N5	B95	40	65	3-400	72,5	1038,5	440,5	1187,5	328	578	242,5	3	1150	205	490	440	24	246
NOS50/125-0.37-4-05	71	0,37	1450	N2	B68	50	65	3-230-400	60	715,5	252,5	855	215	375	170	3	830	145	360	320	19	92
NOS50/125-0.55-4-05	80	0,55	1450	N2	B68	50	65	3-230-400	60	746,5	283,5	855	215	375	170	3	830	145	360	320	19	85
NOS50/125-0.75-4-05	80	0,75	1450	N2	B68	50	65	3-230-400	60	746,5	283,5	855	215	375	170	3	830	145	360	320	19	89
NOS50/160-0.55-4-05	80	0,55	1450	N3	B68	50	65	3-230-400	60	746,5	283,5	955	243	423	190	3	930	165	390	350	19	103
NOS50/160-0.75-4-05	80	0,75	1450	N3	B68	50	65	3-230-400	60	746,5	283,5	955	243	423	190	3	930	165	390	350	19	106
NOS50/160-1.1-4-05	90S	1,1	1450	N3	B68	50	65	3-230-400	60	759,5	296,5	955	243	423	190	3	930	165	390	350	19	116
NOS50/160-1.5-4-05	90L	1,5	1450	N3	B68	50	65	3-230-400	60	779,5	316,5	955	243	423	190	3	930	165	390	350	19	117
NOS50/160-2.2-4-05	100L	2,2	1450	N3	B80	50	65	3-230-400	60	815	352	955	243	423	190	3	930	165	390	350	19	124
NOS50/200-1.1-4-05	90S	1,1	1450	N3	B68	50	65	3-230-400	60	759,5	296,5	955	243	443	190	3	930	165	390	350	19	121
NOS50/200-1.5-4-05	90L	1,5	1450	N3	B68	50	65	3-230-400	60	779,5	316,5	955	243	443	190	3	930	165	390	350	19	121
NOS50/200-2.2-4-05	100L	2,2	1450	N3	B80	50	65	3-230-400	60	815	352	955	243	443	190	3	930	165	390	350	19	128
NOS50/200-3-4-05	100L	3	1450	N3	B80	50	65	3-230-400	60	815	352	955	243	443	190	3	930	165	390	350	19	129
NOS50/250-1.5-4-05	90L	1,5	1450	N4	B68	50	65	3-230-400	72,5	779,5	316,5	1042,5	283	508	197,5	3	1030	185	450	400	24	148
NOS50/250-2.2-4-05	100L	2,2	1450	N4	B80	50	65	3-230-400	72,5	815	352	1042,5	283	508	197,5	3	1030	185	450	400	24	155
NOS50/250-3-4-05	100L	3	1450	N4	B80	50	65	3-230-400	72,5	815	352	1042,5	283	508	197,5	3	1030	185	450	400	24	156
NOS50/250-4-4-05	112M	4	1450	N4	B80	50	65	3-230-400	72,5	858,5	395,5	1042,5	283	508	197,5	3	1030	185	450	400	24	161
NOS50/315-4-4-05	112M	4	1450	N5	B95	50	65	3-230-400	72,5	993,5	395,5	1187,5	328	608	242,5	3	1150	205	490	440	24	241
NOS50/315-5.5-4-05	123S	5,5	1450	N5	B95	50	65	3-400	72,5	1038,5	440,5	1187,5	328	608	242,5	3	1150	205	490	440	24	262
NOS50/315-7.5-4-05	132M	7,5	1450	N5	B95	50	65	3-400	72,5	1073,5	475,5	1187,5	328	608	242,5	3	1150	205	490	440	24	264
NOS50/315-9-4-05	132M	9	1450	N5	B95	50	65	3-400	72,5	1073,5	475,5	1187,5	328	608	242,5	3	1150	205	490	440	24	276
NOS65/125-0.55-4-05	80	0,55	1450	N3	B68	65	80	3-230-400	72,5	746,5	283,5	942,5	243	423	177,5	3	930	165	390	350	19	100
NOS65/125-0.75-4-05	80	0,75	1450	N3	B68	65	80	3-230-400	72,5	746,5	283,5	942,5	243	423	177,5	3	930	165	390	350	19	103
NOS65/125-1.1-4-05	90S	1,1	1450	N3	B68	65	80	3-230-400	72,5	759,5	296,5	942,5	243	423	177,5	3	930	165	390	350	19	113
NOS65/160-0.75-4-05	80	0,75	1450	N3	B68	65	80	3-230-400	72,5	746,5	283,5	942,5	243	443	177,5	3	930	165	390	350	19	109
NOS65/160-1.5-4-05	90L	1,5	1450	N3	B68	65	80	3-230-400	72,5	779,5	316,5	942,5	243	443	177,5	3	930	165	390	350	19	120
NOS65/160-2.2-4-05	100L	2,2	1450	N3	B80	65	80	3-230-400	72,5	815	352	942,5	243	443	177,5	3	930	165	390	350	19	127
NOS65/200-1.1-4-05	90S	1,1	1450	N4	B68	65	80	3-230-400	72,5	759,5	296,5	1042,5	283	508	197,5	3	1030	185	450	400	24	143
NOS65/200-1.5-4-05	90L	1,5	1450	N4	B68	65	80	3-230-400	72,5	779,5	316,5	1042,5	283	508	197,5	3	1030	185	450	400	24	143
NOS65/200-2.2-4-05	100L	2,2	1450	N4	B80	65	80	3-230-400	72,5	815	352	1042,5	283	508	197,5	3	1030	185	450	400	24	150
NOS65/200-3-4-05	100L	3	1450	N4	B80	65	80	3-230-400	72,5	815	352	1042,5	283	508	197,5	3	1030	185	450	400	24	151
NOS65/200-4-4-05	112M	4	1450	N4	B80	65	80	3-230-400	72,5	858,5	395,5	1042,5	283	508	197,5	3	1030	185	450	400	24	156
NOS65/250-2.2-4-05	100L	2,2	1450	N5	B95	65	80	3-230-400	90	925	352	1145	303	553	200	3	1150	205	490	440	24	211
NOS65/250-3-4-05	100L	3	1450	N5	B95	65	80	3-230-400	90	925	352	1145	303	553	200	3	1150	205	490	440	24	212
NOS65/250-4-4-05	112M	4	1450	N5	B95	65	80	3-230-400	90	968,5	395,5	1145	303	553	200	3	1150	205	490	440	24	220
NOS65/250-5.5-4-05	123S	5,5	1450	N5	B95	65	80	3-400	90	1013,5	440,5	1145	303	553	200	3	1150	205	490	440	24	238
NOS65/315-5.5-4-05	123S	5,5	1450	N6	B95	65	8															

## DIMENSIONS – GROUPES – 1450 MIN-1 SANS SPACER

TYPE	Type de carcasse	Kw	min-1	Socle	Type accpt.	DNR	DNS	Tension	Groupe								Socle					Masse Net
									A	L	L3	L4	h3	h4	S1	X	L1	L2	B2	B3	S4	
									mm	mm	mm	mm	mm	mm	mm	mm	mm	mm	mm	mm	mm	
NOS65/315-9-4-05	132M	9	1450	N6	B95	65	80	3-400	90	1073,5	475,5	1305	328	608	240	3	1290	225	540	490	24	311
NOS65/315-11-4-05	160M	11	1450	N6	B95	65	80	3-400	90	1184	586	1305	328	608	240	3	1290	225	540	490	24	319
NOS65/315-15-4-05	160L	15	1450	N6	B110	65	80	3-400	90	1184	586	1305	328	608	240	3	1290	225	540	490	24	335
NOS80/160-1.1-4-05	90S	1,1	1450	N4	B68	80	100	3-230-400	72,5	784,5	296,5	1067,5	283	508	222,5	3	1030	185	450	400	24	141
NOS80/160-1.5-4-05	90L	1,5	1450	N4	B68	80	100	3-230-400	72,5	804,5	316,5	1067,5	283	508	222,5	3	1030	185	450	400	24	141
NOS80/160-2.2-4-05	100L	2,2	1450	N4	B80	80	100	3-230-400	72,5	840	352	1067,5	283	508	222,5	3	1030	185	450	400	24	148
NOS80/160-3-4-05	100L	3	1450	N4	B80	80	100	3-230-400	72,5	840	352	1067,5	283	508	222,5	3	1030	185	450	400	24	149
NOS80/160-4-4-05	112M	4	1450	N4	B80	80	100	3-230-400	72,5	883,5	395,5	1067,5	283	508	222,5	3	1030	185	450	400	24	154
NOS80/200-1.5-4-05	90L	1,5	1450	N5	B95	80	100	3-230-400	72,5	914,5	316,5	1187,5	283	533	242,5	3	1150	205	490	440	24	193
NOS80/200-2.2-4-05	100L	2,2	1450	N5	B95	80	100	3-230-400	72,5	950	352	1187,5	283	533	242,5	3	1150	205	490	440	24	199
NOS80/200-3-4-05	100L	3	1450	N5	B95	80	100	3-230-400	72,5	950	352	1187,5	283	533	242,5	3	1150	205	490	440	24	200
NOS80/200-4-4-05	112M	4	1450	N5	B95	80	100	3-230-400	72,5	993,5	395,5	1187,5	283	533	242,5	3	1150	205	490	440	24	205
NOS80/200-5.5-4-05	123S	5,5	1450	N5	B95	80	100	3-400	72,5	1038,5	440,5	1187,5	283	533	242,5	3	1150	205	490	440	24	225
NOS80/250-3-4-05	100L	3	1450	N6	B95	80	100	3-230-400	90	950	352	1305	303	583	240	3	1290	225	540	490	24	248
NOS80/250-4-4-05	112M	4	1450	N6	B95	80	100	3-230-400	90	993,5	395,5	1305	303	583	240	3	1290	225	540	490	24	256
NOS80/250-5.5-4-05	123S	5,5	1450	N6	B95	80	100	3-400	90	1038,5	440,5	1305	303	583	240	3	1290	225	540	490	24	274
NOS80/250-7.5-4-05	132M	7,5	1450	N6	B95	80	100	3-400	90	1073,5	475,5	1305	303	583	240	3	1290	225	540	490	24	276
NOS80/315-5.5-4-05	123S	5,5	1450	N6	B95	80	100	3-400	90	1038,5	440,5	1305	353	668	240	3	1290	225	540	490	24	302
NOS80/315-7.5-4-05	132M	7,5	1450	N6	B95	80	100	3-400	90	1073,5	475,5	1305	353	668	240	3	1290	225	540	490	24	305
NOS80/315-9-4-05	132M	9	1450	N6	B95	80	100	3-400	90	1073,5	475,5	1305	353	668	240	3	1290	225	540	490	24	317
NOS80/315-11-4-05	160M	11	1450	N6	B95	80	100	3-400	90	1184	586	1305	353	668	240	3	1290	225	540	490	24	328
NOS80/315-15-4-05	160L	15	1450	N6	B110	80	100	3-400	90	1184	586	1305	353	668	240	3	1290	225	540	490	24	344
NOS80/400-11-4-05	160M	11	1450	N7	B95	80	125	3-400	90	1244	586	1455	383	738	265	3	1440	250	610	550	29	441
NOS80/400-15-4-05	160L	15	1450	N7	B110	80	125	3-400	90	1244	586	1455	383	738	265	3	1440	250	610	550	29	458
NOS80/400-18.5-4-05	180M	18,5	1450	N7	B110	80	125	3-400	90	1287	629	1455	383	738	265	3	1440	250	610	550	29	482
NOS80/400-22-4-05	180L	22	1450	N7	B125	80	125	3-400	90	1287	629	1455	383	738	265	3	1440	250	610	550	29	500
NOS80/400-30-4-05	200L	30	1450	N7	B125	80	125	3-400	90	1323	665	1455	383	738	265	3	1440	250	610	550	29	532
NOS100/160-2.2-4-05	100L	2,2	1450	N5	B95	100	125	3-230-400	90	950	352	1170	303	583	225	3	1150	205	490	440	24	220
NOS100/160-3-4-05	100L	3	1450	N5	B95	100	125	3-230-400	90	950	352	1170	303	583	225	3	1150	205	490	440	24	221
NOS100/160-4-4-05	112M	4	1450	N5	B95	100	125	3-230-400	90	993,5	395,5	1170	303	583	225	3	1150	205	490	440	24	228
NOS100/160-5.5-4-05	123S	5,5	1450	N5	B95	100	125	3-400	90	1038,5	440,5	1170	303	583	225	3	1150	205	490	440	24	246
NOS100/200-2.2-4-05	100L	2,2	1450	N5	B95	100	125	3-230-400	90	950	352	1170	303	583	225	3	1150	205	490	440	24	211
NOS100/200-3-4-05	100L	3	1450	N5	B95	100	125	3-230-400	90	950	352	1170	303	583	225	3	1150	205	490	440	24	212
NOS100/200-4-4-05	112M	4	1450	N5	B95	100	125	3-230-400	90	993,5	395,5	1170	303	583	225	3	1150	205	490	440	24	220
NOS100/200-5.5-4-05	123S	5,5	1450	N5	B95	100	125	3-400	90	1038,5	440,5	1170	303	583	225	3	1150	205	490	440	24	238
NOS100/200-7.5-4-05	132M	7,5	1450	N5	B95	100	125	3-400	90	1073,5	475,5	1170	303	583	225	3	1150	205	490	440	24	240
NOS100/250-4-4-05	112M	4	1450	N6	B95	100	125	3-230-400	90	1008,5	395,5	1320	328	608	255	3	1290	225	540	490	24	269
NOS100/250-5.5-4-05	123S	5,5	1450	N6	B95	100	125	3-400	90	1053,5	440,5	1320	328	608	255	3	1290	225	540	490	24	290
NOS100/250-7.5-4-05	132M	7,5	1450	N6	B95	100	125	3-400	90	1088,5	475,5	1320	328	608	255	3	1290	225	540	490	24	292
NOS100/250-9-4-05	132M	9	1450	N6	B95	100	125	3-400	90	1088,5	475,5	1320	328	608	255	3	1290	225	540	490	24	304
NOS100/250-11-4-05	160M	11	1450	N6	B95	100	125	3-400	90	1199	586	1320	328	608	255	3	1290	225	540	490	24	311
NOS100/315-11-4-05	160M	11	1450	N6	B95	100	125	3-400	90	1199	586	1320	353	668	255	3	1290	225	540	490	24	337
NOS100/315-15-4-05	160L	15	1450	N6	B110	100	125	3-400	90	1199	586	1320	353	668	255	3	1290	225	540	490	24	354
NOS100/315-18.5-4-05	180M	18,5	1450	N6	B110	100	125	3-400	90	1242	629	1320	353	668	255	3	1290	225	540	490	24	378
NOS100/315-22-4-05	180L	22	1450	N6	B125	100	125	3-400	90	1242	629	1320	353	668	255	3	1290	225	540	490	24	395
NOS100/400-15-4-05	160L	15	1450	N8	B110	100	125	3-400	110	1259	586	1650	403	758	300	3	1640	290	660	600	29	511
NOS100/400-18.5-4-05	180M	18,5	1450	N8	B110	100	125	3-400	110	1302	629	1650	403	758	300	3	1640	290	660	600	29	535
NOS100/400-22-4-05	180L	22	1450	N8	B125	100	125	3-400	110	1302	629	1650	403	758	300	3	1640	290	660	600	29	553
NOS100/400-30-4-05	200L	30	1450	N8	B125	100	125	3-400	110	1338	665	1650	403	758	300	3	1640	290	660	600	29	584
NOS100/400-37-4-05	225S	37	1450	N8	B140	100	125	3-400	110	1438	765	1650	403	758	300	3	1640	290	660	600	29	638
NOS100/400-45-4-05	225M	45	1450	N8	B140	100	125	3-400	110	1438	765	1650	403	758	300	3	1640	290	660	600	29	672
NOS125/200-7.5-4-05	132M	7,5	1450	N6	B95	125	150	3-400	90	1088,5	475,5	1320	353	668	255	3</						



## DIMENSIONS – GROUPES – 1450 MIN-1 SANS SPACER

TYPE	Type de carcassee	Kw	min-1	Socle	Type accpt.	DNR	DNS	Tension	Groupe								Socle					Masse Net
									A	L	L3	L4	h3	h4	S1	X	L1	L2	B2	B3	S4	
									mm	mm	mm	mm	mm	mm	mm	mm	mm	mm	mm	mm	mm	
NOS125/200-11-4-05	160M	11	1450	N6	B95	125	150	3-400	90	1199	586	1320	353	668	255	3	1290	225	540	490	24	333
NOS125/200-15-4-05	160L	15	1450	N6	B110	125	150	3-400	90	1199	586	1320	353	668	255	3	1290	225	540	490	24	350
NOS125/250-7.5-4-05	132M	7,5	1450	N6	B95	125	150	3-400	90	1088,5	475,5	1320	353	708	255	3	1290	225	540	490	24	312
NOS125/250-9-4-05	132M	9	1450	N6	B95	125	150	3-400	90	1088,5	475,5	1320	353	708	255	3	1290	225	540	490	24	324
NOS125/250-11-4-05	160M	11	1450	N6	B95	125	150	3-400	90	1199	586	1320	353	708	255	3	1290	225	540	490	24	335
NOS125/250-15-4-05	160L	15	1450	N6	B110	125	150	3-400	90	1199	586	1320	353	708	255	3	1290	225	540	490	24	352
NOS125/250-18.5-4-05	180M	18,5	1450	N6	B110	125	150	3-400	90	1242	629	1320	353	708	255	3	1290	225	540	490	24	376
NOS125/315-15-4-05	160L	15	1450	N8	B110	125	150	3-400	110	1259	586	1650	403	758	300	3	1640	290	660	600	29	489
NOS125/315-18.5-4-05	180M	18,5	1450	N8	B110	125	150	3-400	110	1302	629	1650	403	758	300	3	1640	290	660	600	29	513
NOS125/315-22-4-05	180L	22	1450	N8	B125	125	150	3-400	110	1302	629	1650	403	758	300	3	1640	290	660	600	29	531
NOS125/315-30-4-05	200L	30	1450	N8	B125	125	150	3-400	110	1338	665	1650	403	758	300	3	1640	290	660	600	29	562
NOS125/315-37-4-05	225S	37	1450	N8	B140	125	150	3-400	110	1438	765	1650	403	758	300	3	1640	290	660	600	29	617
NOS125/400-30-4-05	200L	30	1450	N8	B125	125	150	3-400	110	1338	665	1650	438	838	300	3	1640	290	660	600	29	606
NOS125/400-37-4-05	225S	37	1450	N8	B140	125	150	3-400	110	1438	765	1650	438	838	300	3	1640	290	660	600	29	660
NOS125/400-45-4-05	225M	45	1450	N8	B140	125	150	3-400	110	1438	765	1650	438	838	300	3	1640	290	660	600	29	694
NOS125/400-55-4-05	250M	55	1450	N8	B160	125	150	3-400	110	1457	784	1650	438	838	300	3	1640	290	660	600	29	725
NOS125/400-75-4-05	280S	75	1450	N9	B180	125	150	3-400	110	1744	1071	1850	438	838	330	3	1840	320	730	670	29	1175
NOS150/200-7.5-4-05	132M	7,5	1450	N9	B95	150	200	3-400	110	1108,5	475,5	1870	403	803	350	3	1840	320	730	670	29	517
NOS150/200-9-4-05	132M	9	1450	N9	B95	150	200	3-400	110	1108,5	475,5	1870	403	803	350	3	1840	320	730	670	29	530
NOS150/200-11-4-05	160M	11	1450	N9	B95	150	200	3-400	110	1219	586	1870	403	803	350	3	1840	320	730	670	29	543
NOS150/200-15-4-05	160L	15	1450	N9	B110	150	200	3-400	110	1219	586	1870	403	803	350	3	1840	320	730	670	29	560
NOS150/200-18.5-4-05	180M	18,5	1450	N9	B110	150	200	3-400	110	1262	629	1870	403	803	350	3	1840	320	730	670	29	584
NOS150/250-15-4-05	160L	15	1450	N8	B110	150	200	3-400	110	1219	586	1670	403	803	320	3	1640	290	660	600	29	472
NOS150/250-18.5-4-05	180M	18,5	1450	N8	B110	150	200	3-400	110	1262	629	1670	403	803	320	3	1640	290	660	600	29	496
NOS150/250-22-4-05	180L	22	1450	N8	B125	150	200	3-400	110	1262	629	1670	403	803	320	3	1640	290	660	600	29	514
NOS150/250-30-4-05	200L	30	1450	N8	B125	150	200	3-400	110	1298	665	1670	403	803	320	3	1640	290	660	600	29	545
NOS150/315-22-4-05	180L	22	1450	N9	B125	150	200	3-400	110	1322	629	1870	403	803	350	3	1840	320	730	670	29	639
NOS150/315-30-4-05	200L	30	1450	N9	B125	150	200	3-400	110	1358	665	1870	403	803	350	3	1840	320	730	670	29	671
NOS150/315-37-4-05	225S	37	1450	N9	B140	150	200	3-400	110	1458	765	1870	403	803	350	3	1840	320	730	670	29	725
NOS150/315-45-4-05	225M	45	1450	N9	B140	150	200	3-400	110	1458	765	1870	403	803	350	3	1840	320	730	670	29	759
NOS150/315-55-4-05	250M	55	1450	N9	B160	150	200	3-400	110	1477	784	1870	403	803	350	3	1840	320	730	670	29	790
NOS150/400-45-4-05	225M	45	1450	N9	B140	150	200	3-400	110	1458	765	1870	438	888	350	3	1840	320	730	670	29	819
NOS150/400-55-4-05	250M	55	1450	N9	B160	150	200	3-400	110	1477	784	1870	438	888	350	3	1840	320	730	670	29	849
NOS150/400-75-4-05	280S	75	1450	N9	B180	150	200	3-400	110	1764	1071	1870	438	888	350	3	1840	320	730	670	29	1206
NOS150/400-90-4-05	280M	90	1450	N9	B180	150	200	3-400	110	1764	1071	1870	438	888	350	3	1840	320	730	670	29	1241

## DIMENSIONS – GROUPES – 2900 MIN-1 AVEC SPACER

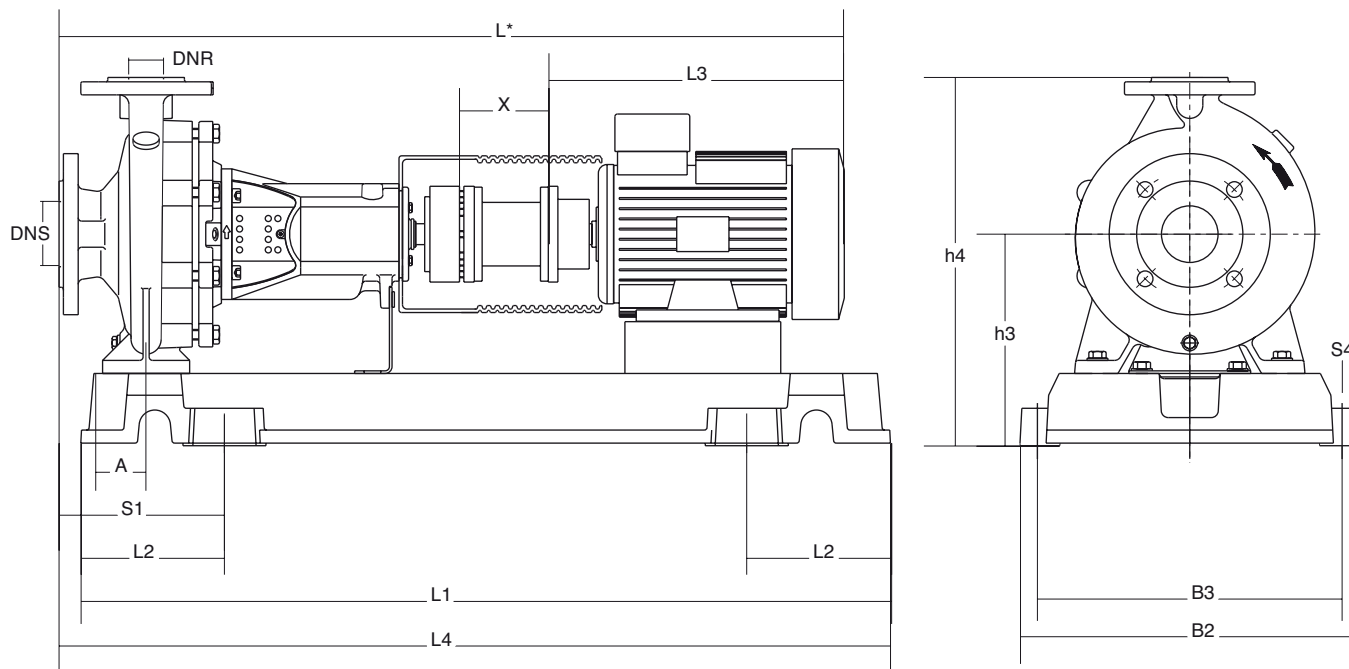

\*: Cotes liées au moteur, non contractuel

Récupérateur d'égoutures et 3ème point de fixation optionels voir tableau

Brides aspiration-refoulement usinées suivant norme ISO 7005 voir encombrement pompe nue

## DIMENSIONS – GROUPES – 2900 MIN-1 AVEC SPACER

TYPE	Type de carcasse	Kw	min-1	Socle	Type accept.	DNR	DNS	Tension	Groupe								Socle					Masse Net	
									A	L	L3	L4	h3	h4	S1	X	L1	L2	B2	B3	S4		
									mm	mm	mm	mm	mm	mm	mm	mm	mm	mm	mm	mm	mm	mm	kg
NOS32/125-0.55-2-12	71	0,55	2900	N2	H80	32	50	3-230-400	60	792,5	252,5	835	195	335	150	100	830	145	360	320	19	85	
NOS32/125-0.75-2-12	80	0,75	2900	N2	H80	32	50	3-230-400	60	823,5	283,5	835	195	335	150	100	830	145	360	320	19	89	
NOS32/125-1.1-2-12	80	1,1	2900	N2	H80	32	50	3-230-400	60	823,5	283,5	835	195	335	150	100	830	145	360	320	19	92	
NOS32/125-1.5-2-12	90S	1,5	2900	N2	H80	32	50	3-230-400	60	836,5	296,5	835	195	335	150	100	830	145	360	320	19	96	
NOS32/125-2.2-2-12	90L	2,2	2900	N3	H80	32	50	3-230-400	60	856,5	316,5	935	195	335	170	100	930	165	390	350	19	107	
NOS32/160-1.5-2-12	90S	1,5	2900	N2	H80	32	50	3-230-400	60	836,5	296,5	835	215	375	150	100	830	145	360	320	19	99	
NOS32/160-2.2-2-12	90L	2,2	2900	N3	H80	32	50	3-230-400	60	856,5	316,5	935	215	375	170	100	930	165	390	350	19	109	
NOS32/160-3-2-12	100L	3	2900	N3	H80	32	50	3-230-400	60	892	352	935	215	375	170	100	930	165	390	350	19	118	
NOS32/160-4-2-12	112M	4	2900	N3	H80	32	50	3-230-400	60	935,5	395,5	935	215	375	170	100	930	165	390	350	19	123	
NOS32/160-5.5-2-12	132S	5,5	2900	N3	H95	32	50	3-400	60	980,5	440,5	935	215	375	170	100	930	165	390	350	19	138	
NOS32/160B-1.5-2-12	90S	1,5	2900	N2	H80	32	50	3-230-400	60	836,5	296,5	835	215	375	150	100	830	145	360	320	19	99	
NOS32/160B-2.2-2-12	90L	2,2	2900	N3	H80	32	50	3-230-400	60	856,5	316,5	935	215	375	170	100	930	165	390	350	19	109	
NOS32/160B-3-2-12	100L	3	2900	N3	H80	32	50	3-230-400	60	892	352	935	215	375	170	100	930	165	390	350	19	118	
NOS32/160B-4-2-12	112M	4	2900	N3	H80	32	50	3-230-400	60	935,5	395,5	935	215	375	170	100	930	165	390	350	19	123	
NOS32/160B-5.5-2-12	132S	5,5	2900	N3	H95	32	50	3-400	60	980,5	440,5	935	215	375	170	100	930	165	390	350	19	138	
NOS32/200-2.2-2-12	90L	2,2	2900	N3	H80	32	50	3-230-400	60	856,5	316,5	935	243	423	170	100	930	165	390	350	19	117	
NOS32/200-3-2-12	100L	3	2900	N3	H80	32	50	3-230-400	60	892	352	935	243	423	170	100	930	165	390	350	19	124	
NOS32/200-4-2-12	112M	4	2900	N3	H80	32	50	3-230-400	60	935,5	395,5	935	243	423	170	100	930	165	390	350	19	127	

## DIMENSIONS – GROUPES – 2900 MIN-1 AVEC SPACER

TYPE	Type de carcasse	Kw	min-1	Socle	Type accept.	DNR	DNS	Tension	Groupe								Socle					Masse Net
									A	L	L3	L4	h3	h4	S1	X	L1	L2	B2	B3	S4	
									V	mm	mm	mm	mm	mm	mm	mm	mm	mm	mm	mm	mm	
NOS32/200-5.5-2-12	132S	5,5	2900	N3	H95	32	50	3-400	60	980,5	440,5	935	243	423	170	100	930	165	390	350	19	143
NOS32/200-7.5-2-12	132S	7,5	2900	N3	H95	32	50	3-400	60	980,5	440,5	935	243	423	170	100	930	165	390	350	19	149
NOS32/200-9-2-12	132M	9	2900	N3	H95	32	50	3-400	60	1015,5	475,5	935	243	423	170	100	930	165	390	350	19	148
NOS32/200-11-2-12	160M	11	2900	N4	H95	32	50	3-400	60	1126	586	1035	263	443	190	100	1030	185	450	400	24	175
NOS32/200B-2.2-2-12	90L	2,2	2900	N3	H80	32	50	3-230-400	60	856,5	316,5	935	243	423	170	100	930	165	390	350	19	117
NOS32/200B-3-2-12	100L	3	2900	N3	H80	32	50	3-230-400	60	892	352	935	243	423	170	100	930	165	390	350	19	124
NOS32/200B-4-2-12	112M	4	2900	N3	H80	32	50	3-230-400	60	935,5	395,5	935	243	423	170	100	930	165	390	350	19	127
NOS32/200B-5.5-2-12	132S	5,5	2900	N3	H95	32	50	3-400	60	980,5	440,5	935	243	423	170	100	930	165	390	350	19	143
NOS32/200B-7.5-2-12	132S	7,5	2900	N3	H95	32	50	3-400	60	980,5	440,5	935	243	423	170	100	930	165	390	350	19	149
NOS32/200B-9-2-12	132M	9	2900	N3	H95	32	50	3-400	60	1015,5	475,5	935	243	423	170	100	930	165	390	350	19	148
NOS32/200B-11-2-12	160M	11	2900	N4	H95	32	50	3-400	60	1126	586	1035	263	443	190	100	1030	185	450	400	24	175
NOS32/250-7.5-2-12	132S	7,5	2900	N4	H95	32	50	3-400	72,5	1000,5	440,5	1042,5	283	508	197,5	100	1030	185	450	400	24	176
NOS32/250-9-2-12	132M	9	2900	N4	H95	32	50	3-400	72,5	1035,5	475,5	1042,5	283	508	197,5	100	1030	185	450	400	24	175
NOS32/250-11-2-12	160M	11	2900	N4	H95	32	50	3-400	72,5	1146	586	1042,5	283	508	197,5	100	1030	185	450	400	24	192
NOS32/250-15-2-12	160M	15	2900	N4	H95	32	50	3-400	72,5	1146	586	1042,5	283	508	197,5	100	1030	185	450	400	24	204
NOS40/125-1.1-2-12	80	1,1	2900	N2	H80	40	65	3-230-400	60	823,5	283,5	835	195	335	150	100	830	145	360	320	19	88
NOS40/125-1.5-2-12	90S	1,5	2900	N2	H80	40	65	3-230-400	60	836,5	296,5	835	195	335	150	100	830	145	360	320	19	93
NOS40/125-2.2-2-12	90L	2,2	2900	N3	H80	40	65	3-230-400	60	856,5	316,5	935	195	335	170	100	930	165	390	350	19	103
NOS40/125-3-2-12	100L	3	2900	N3	H80	40	65	3-230-400	60	892	352	935	195	335	170	100	930	165	390	350	19	111
NOS40/160-2.2-2-12	90L	2,2	2900	N3	H80	40	65	3-230-400	60	856,5	316,5	935	215	375	170	100	930	165	390	350	19	106
NOS40/160-3-2-12	100L	3	2900	N3	H80	40	65	3-230-400	60	892	352	935	215	375	170	100	930	165	390	350	19	115
NOS40/160-4-2-12	112M	4	2900	N3	H80	40	65	3-230-400	60	935,5	395,5	935	215	375	170	100	930	165	390	350	19	120
NOS40/160-5.5-2-12	132S	5,5	2900	N3	H95	40	65	3-400	60	980,5	440,5	935	215	375	170	100	930	165	390	350	19	135
NOS40/160-7.5-2-12	132S	7,5	2900	N3	H95	40	65	3-400	60	980,5	440,5	935	215	375	170	100	930	165	390	350	19	142
NOS40/160-9-2-12	132M	9	2900	N3	H95	40	65	3-400	60	1015,5	475,5	935	215	375	170	100	930	165	390	350	19	140
NOS40/200-5.5-2-12	132S	5,5	2900	N3	H95	40	65	3-400	60	1000,5	440,5	955	243	423	190	100	930	165	390	350	19	145
NOS40/200-7.5-2-12	132S	7,5	2900	N3	H95	40	65	3-400	60	1000,5	440,5	955	243	423	190	100	930	165	390	350	19	151
NOS40/200-9-2-12	132M	9	2900	N3	H95	40	65	3-400	60	1035,5	475,5	955	243	423	190	100	930	165	390	350	19	150
NOS40/200-11-2-12	160M	11	2900	N4	H95	40	65	3-400	60	1146	586	1055	263	443	210	100	1030	185	450	400	24	178
NOS40/200-15-2-12	160M	15	2900	N4	H95	40	65	3-400	60	1146	586	1055	263	443	210	100	1030	185	450	400	24	190
NOS40/200-18.5-2-12	160L	18,5	2900	N5	H95	40	65	3-400	60	1146	586	1175	263	443	230	100	1150	205	490	440	24	234
NOS40/250-7.5-2-12	132S	7,5	2900	N4	H95	40	65	3-400	72,5	1000,5	440,5	1042,5	283	508	197,5	100	1030	185	450	400	24	176
NOS40/250-9-2-12	132M	9	2900	N4	H95	40	65	3-400	72,5	1035,5	475,5	1042,5	283	508	197,5	100	1030	185	450	400	24	175
NOS40/250-11-2-12	160M	11	2900	N4	H95	40	65	3-400	72,5	1146	586	1042,5	283	508	197,5	100	1030	185	450	400	24	192
NOS40/250-15-2-12	160M	15	2900	N4	H95	40	65	3-400	72,5	1146	586	1042,5	283	508	197,5	100	1030	185	450	400	24	204
NOS40/250-18.5-2-12	160L	18,5	2900	N5	H95	40	65	3-400	72,5	1146	586	1162,5	283	508	217,5	100	1150	205	490	440	24	249
NOS40/315-15-2-12	160M	15	2900	N6	H95	40	65	3-400	72,5	1281	586	1322,5	328	578	257,5	100	1290	225	540	490	24	305
NOS40/315-18.5-2-12	160L	18,5	2900	N6	H95	40	65	3-400	72,5	1281	586	1322,5	328	578	257,5	100	1290	225	540	490	24	316
NOS40/315-22-2-12	180M	22	2900	N6	H110	40	65	3-400	72,5	1324	629	1322,5	328	578	257,5	100	1290	225	540	490	24	333
NOS40/315-30-2-12	200L	30	2900	N6	H125	40	65	3-400	72,5	1360	665	1322,5	328	578	257,5	100	1290	225	540	490	24	369
NOS40/315-37-2-12	200L	37	2900	N6	H125	40	65	3-400	72,5	1360	665	1322,5	328	578	257,5	100	1290	225	540	490	24	402
NOS50/125-1.5-2-12	90S	1,5	2900	N2	H80	50	65	3-230-400	60	856,5	296,5	855	215	375	170	100	830	145	360	320	19	96
NOS50/125-2.2-2-12	90L	2,2	2900	N3	H80	50	65	3-230-400	60	876,5	316,5	955	215	375	190	100	930	165	390	350	19	106
NOS50/125-3-2-12	100L	3	2900	N3	H80	50	65	3-230-400	60	912	352	955	215	375	190	100	930	165	390	350	19	115
NOS50/125-4-2-12	112M	4	2900	N3	H80	50	65	3-230-400	60	955,5	395,5	955	215	375	190	100	930	165	390	350	19	120
NOS50/125-5.5-2-12	132S	5,5	2900	N3	H95	50	65	3-400	60	1000,5	440,5	955	215	375	190	100	930	165	390	350	19	135
NOS50/160-3-2-12	100L	3	2900	N3	H80	50	65	3-230-400	60	912	352	955	243	423	190	100	930	165	390	350	19	126
NOS50/160-4-2-12	112M	4	2900	N3	H95	50	65	3-230-400	60	955,5	395,5	955	243	423	190	100	930	165	390	350	19	130
NOS50/160-5.5-2-12	132S	5,5	2900	N3	H95	50	65	3-400	60	1000,5	440,5	955	243	423	190	100	930	165	390	350	19	145
NOS50/160-7.5-2-12	132S	7,5	2900	N3	H95	50	65	3-400	60	1000,5	440,5	955	243	423	190	100	930	165	390	350	19	151

## DIMENSIONS – GROUPES – 2900 MIN-1 AVEC SPACER

TYPE	Type de carcasse	Kw	min-1	Socle	Type accept.	DNR	DNS	Tension	Groupe								Socle					Masse Net
									A	L	L3	L4	h3	h4	S1	X	L1	L2	B2	B3	S4	
									V	mm	mm	mm	mm	mm	mm	mm	mm	mm	mm	mm	mm	
NOS50/160-9-2-12	132M	9	2900	N3	H95	50	65	3-400	60	1035,5	475,5	955	243	423	190	100	930	165	390	350	19	150
NOS50/160-11-2-12	160M	11	2900	N4	H95	50	65	3-400	60	1146	586	1055	263	443	210	100	1030	185	450	400	24	178
NOS50/160-15-2-12	160M	15	2900	N4	H95	50	65	3-400	60	1146	586	1055	263	443	210	100	1030	185	450	400	24	190
NOS50/200-7.5-2-12	132S	7,5	2900	N3	H95	50	65	3-400	60	1000,5	440,5	955	243	443	190	100	930	165	390	350	19	155
NOS50/200-9-2-12	132M	9	2900	N3	H95	50	65	3-400	60	1035,5	475,5	955	243	443	190	100	930	165	390	350	19	154
NOS50/200-11-2-12	160M	11	2900	N4	H95	50	65	3-400	60	1146	586	1055	263	463	210	100	1030	185	450	400	24	182
NOS50/200-15-2-12	160M	15	2900	N4	H95	50	65	3-400	60	1146	586	1055	263	463	210	100	1030	185	450	400	24	194
NOS50/200-18.5-2-12	160L	18,5	2900	N5	H95	50	65	3-400	60	1146	586	1175	263	463	230	100	1150	205	490	440	24	238
NOS50/200-22-2-12	180M	22	2900	N5	H110	50	65	3-400	60	1189	629	1175	283	483	230	100	1150	205	490	440	24	263
NOS50/250-11-2-12	160M	11	2900	N4	H95	50	65	3-400	72,5	1146	586	1042,5	283	508	197,5	100	1030	185	450	400	24	196
NOS50/250-15-2-12	160M	15	2900	N4	H95	50	65	3-400	72,5	1146	586	1042,5	283	508	197,5	100	1030	185	450	400	24	208
NOS50/250-18.5-2-12	160L	18,5	2900	N5	H95	50	65	3-400	72,5	1146	586	1162,5	283	508	217,5	100	1150	205	490	440	24	253
NOS50/250-22-2-12	180M	22	2900	N5	H110	50	65	3-400	72,5	1189	629	1162,5	283	508	217,5	100	1150	205	490	440	24	269
NOS50/250-30-2-12	200L	30	2900	N6	H125	50	65	3-400	72,5	1225	665	1297,5	303	528	232,5	100	1290	225	540	490	24	345
NOS50/315-15-2-12	160M	15	2900	N6	H95	50	65	3-400	72,5	1281	586	1322,5	328	608	257,5	100	1290	225	540	490	24	321
NOS50/315-18.5-2-12	160L	18,5	2900	N6	H95	50	65	3-400	72,5	1281	586	1322,5	328	608	257,5	100	1290	225	540	490	24	331
NOS50/315-22-2-12	180M	22	2900	N6	H110	50	65	3-400	72,5	1324	629	1322,5	328	608	257,5	100	1290	225	540	490	24	348
NOS50/315-30-2-12	200L	30	2900	N6	H125	50	65	3-400	72,5	1360	665	1322,5	328	608	257,5	100	1290	225	540	490	24	385
NOS50/315-37-2-12	200L	37	2900	N6	H125	50	65	3-400	72,5	1360	665	1322,5	328	608	257,5	100	1290	225	540	490	24	418
NOS50/315-45-2-12	225S-M	45	2900	N7	H125	50	65	3-400	72,5	1430	735	1472,5	328	608	282,5	100	1440	250	610	550	29	530
NOS50/315-55-2-12	250S-M	55	2900	N7	H140	50	65	3-400	72,5	1479	784	1472,5	353	633	282,5	100	1440	250	610	550	29	542
NOS50/315-75-2-12	280S-M	75	2900	N9	H160	50	65	3-400	72,5	1766	1071	1872,5	403	683	352,5	100	1840	320	730	670	29	1079
NOS65/125-3-2-12	100L	3	2900	N3	H80	65	80	3-230-400	72,5	912	352	942,5	243	423	177,5	100	930	165	390	350	19	123
NOS65/125-4-2-12	112M	4	2900	N3	H80	65	80	3-230-400	72,5	955,5	395,5	942,5	243	423	177,5	100	930	165	390	350	19	126
NOS65/125-5.5-2-12	132S	5,5	2900	N3	H95	65	80	3-400	72,5	1000,5	440,5	942,5	243	423	177,5	100	930	165	390	350	19	142
NOS65/125-7.5-2-12	132S	7,5	2900	N3	H95	65	80	3-400	72,5	1000,5	440,5	942,5	243	423	177,5	100	930	165	390	350	19	148
NOS65/125-9-2-12	132M	9	2900	N3	H95	65	80	3-400	72,5	1035,5	475,5	942,5	243	423	177,5	100	930	165	390	350	19	147
NOS65/160-5.5-2-12	132S	5,5	2900	N3	H95	65	80	3-400	72,5	1000,5	440,5	942,5	243	443	177,5	100	930	165	390	350	19	148
NOS65/160-7.5-2-12	132S	7,5	2900	N3	H95	65	80	3-400	72,5	1000,5	440,5	942,5	243	443	177,5	100	930	165	390	350	19	154
NOS65/160-9-2-12	132M	9	2900	N3	H95	65	80	3-400	72,5	1035,5	475,5	942,5	243	443	177,5	100	930	165	390	350	19	153
NOS65/160-11-2-12	160M	11	2900	N4	H95	65	80	3-400	72,5	1146	586	1042,5	263	463	197,5	100	1030	185	450	400	24	181
NOS65/160-15-2-12	160M	15	2900	N4	H95	65	80	3-400	72,5	1146	586	1042,5	263	463	197,5	100	1030	185	450	400	24	193
NOS65/160-18.5-2-12	160L	18,5	2900	N5	H95	65	80	3-400	72,5	1146	586	1162,5	263	463	217,5	100	1150	205	490	440	24	237
NOS65/200-9-2-12	132M	9	2900	N4	H95	65	80	3-400	72,5	1035,5	475,5	1042,5	283	508	197,5	100	1030	185	450	400	24	174
NOS65/200-11-2-12	160M	11	2900	N5	H95	65	80	3-400	72,5	1146	586	1162,5	283	508	217,5	100	1150	205	490	440	24	225
NOS65/200-15-2-12	160M	15	2900	N5	H95	65	80	3-400	72,5	1146	586	1162,5	283	508	217,5	100	1150	205	490	440	24	237
NOS65/200-18.5-2-12	160L	18,5	2900	N5	H95	65	80	3-400	72,5	1146	586	1162,5	283	508	217,5	100	1150	205	490	440	24	248
NOS65/200-22-2-12	180M	22	2900	N5	H110	65	80	3-400	72,5	1189	629	1162,5	283	508	217,5	100	1150	205	490	440	24	264
NOS65/200-30-2-12	200L	30	2900	N6	H125	65	80	3-400	72,5	1225	665	1297,5	303	528	232,5	100	1290	225	540	490	24	340
NOS65/250-18.5-2-12	160L	18,5	2900	N6	H95	65	80	3-400	90	1256	586	1280	303	553	215	100	1290	225	540	490	24	308
NOS65/250-22-2-12	180M	22	2900	N6	H110	65	80	3-400	90	1299	629	1280	303	553	215	100	1290	225	540	490	24	325
NOS65/250-30-2-12	200L	30	2900	N7	H125	65	80	3-400	90	1335	665	1430	303	553	240	100	1440	250	610	550	29	408
NOS65/250-37-2-12	200L	37	2900	N7	H125	65	80	3-400	90	1335	665	1430	303	553	240	100	1440	250	610	550	29	441
NOS65/250-45-2-12	225S-M	45	2900	N7	H125	65	80	3-400	90	1405	735	1430	328	578	240	100	1440	250	610	550	29	520
NOS80/160-7.5-2-12	132S	7,5	2900	N4	H95	80	100	3-400	72,5	1065,5	440,5	1067,5	283	508	222,5	140	1030	185	450	400	24	173
NOS80/160-9-2-12	132M	9	2900	N4	H95	80	100	3-400	72,5	1100,5	475,5	1067,5	283	508	222,5	140	1030	185	450	400	24	172
NOS80/160-11-2-12	160M	11	2900	N5	H95	80	100	3-400	72,5	1211	586	1187,5	283	508	242,5	140	1150	205	490	440	24	223
NOS80/160-15-2-12	160M	15	2900	N5	H95	80	100	3-400	72,5	1211	586	1187,5	283	508	242,5	140	1150	205	490	440	24	236
NOS80/160-18.5-2-12	160L	18,5	2900	N5	H95	80	100	3-400	72,5	1211	586	1187,5	283	508	242,5	140	1150	205	490	440	24	246
NOS80/160-22-2-12	180M	22	2900	N5	H110	80	100	3-400	72,5	1254	629	1187,5	283	508	242,5	140	1150	205	490	440	24	262

## DIMENSIONS – GROUPES – 2900 MIN-1 AVEC SPACER

TYPE	Type de carcasse	Kw	min-1	Socle	Type accept.	DNR	DNS	Tension	Groupe								Socle					Masse Net
									A	L	L3	L4	h3	h4	S1	X	L1	L2	B2	B3	S4	
									V	mm	mm	mm	mm	mm	mm	mm	mm	mm	mm	mm	mm	
NOS80/160-30-2-12	200L	30	2900	N6	H125	80	100	3-400	72,5	1290	665	1322,5	303	528	257,5	140	1290	225	540	490	24	339
NOS80/200-15-2-12	160M	15	2900	N6	H95	80	100	3-400	72,5	1321	586	1322,5	283	533	257,5	140	1290	225	540	490	24	284
NOS80/200-18.5-2-12	160L	18,5	2900	N6	H95	80	100	3-400	72,5	1321	586	1322,5	283	533	257,5	140	1290	225	540	490	24	294
NOS80/200-22-2-12	180M	22	2900	N6	H110	80	100	3-400	72,5	1364	629	1322,5	283	533	257,5	140	1290	225	540	490	24	311
NOS80/200-30-2-12	200L	30	2900	N7	H125	80	100	3-400	72,5	1400	665	1472,5	303	553	282,5	140	1440	250	610	550	29	401
NOS80/200-37-2-12	200L	37	2900	N7	H125	80	100	3-400	72,5	1400	665	1472,5	303	553	282,5	140	1440	250	610	550	29	434
NOS80/200-45-2-12	225S-M	45	2900	N7	H125	80	100	3-400	72,5	1470	735	1472,5	328	578	282,5	140	1440	250	610	550	29	513
NOS80/250-22-2-12	180M	22	2900	N6	H110	80	100	3-400	90	1364	629	1305	303	583	240	140	1290	225	540	490	24	330
NOS80/250-30-2-12	200L	30	2900	N7	H125	80	100	3-400	90	1400	665	1455	303	583	265	140	1440	250	610	550	29	413
NOS80/250-37-2-12	200L	37	2900	N7	H125	80	100	3-400	90	1400	665	1455	303	583	265	140	1440	250	610	550	29	446
NOS80/250-45-2-12	225S-M	45	2900	N7	H125	80	100	3-400	90	1470	735	1455	328	608	265	140	1440	250	610	550	29	525
NOS80/250-55-2-12	250S-M	55	2900	N7	H140	80	100	3-400	90	1519	784	1455	353	633	265	140	1440	250	610	550	29	540
NOS100/160-18.5-2-12	160L	18,5	2900	N6	H95	100	125	3-400	90	1321	586	1305	303	583	240	140	1290	225	540	490	24	317
NOS100/160-22-2-12	180M	22	2900	N6	H110	100	125	3-400	90	1364	629	1305	303	583	240	140	1290	225	540	490	24	333
NOS100/160-30-2-12	200L	30	2900	N7	H125	100	125	3-400	90	1400	665	1455	303	583	265	140	1440	250	610	550	29	416
NOS100/160-37-2-12	200L	37	2900	N7	H125	100	125	3-400	90	1400	665	1455	303	583	265	140	1440	250	610	550	29	449
NOS100/200-18.5-2-12	160L	18,5	2900	N6	H95	100	125	3-400	90	1321	586	1305	303	583	240	140	1290	225	540	490	24	308
NOS100/200-22-2-12	180M	22	2900	N6	H110	100	125	3-400	90	1364	629	1305	303	583	240	140	1290	225	540	490	24	325
NOS100/200-30-2-12	200L	30	2900	N7	H125	100	125	3-400	90	1400	665	1455	303	583	265	140	1440	250	610	550	29	408
NOS100/200-37-2-12	200L	37	2900	N7	H125	100	125	3-400	90	1400	665	1455	303	583	265	140	1440	250	610	550	29	441
NOS100/200-45-2-12	225S-M	45	2900	N7	H125	100	125	3-400	90	1470	735	1455	328	608	265	140	1440	250	610	550	29	520
NOS100/250-30-2-12	200L	30	2900	N7	H125	100	125	3-400	90	1415	665	1470	328	608	280	140	1440	250	610	550	29	428
NOS100/250-37-2-12	200L	37	2900	N7	H125	100	125	3-400	90	1415	665	1470	328	608	280	140	1440	250	610	550	29	461
NOS100/250-45-2-12	225S-M	45	2900	N7	H125	100	125	3-400	90	1485	735	1470	328	608	280	140	1440	250	610	550	29	528
NOS100/250-55-2-12	250S-M	55	2900	N7	H140	100	125	3-400	90	1534	784	1470	353	633	280	140	1440	250	610	550	29	542
NOS100/250-75-2-12	280S-M	75	2900	N9	H160	100	125	3-400	90	1821	1071	1870	403	683	350	140	1840	320	730	670	29	1079
NOS100/250-90-2-12	280S-M	90	2900	N9	H160	100	125	3-400	90	1821	1071	1870	403	683	350	140	1840	320	730	670	29	1103
NOS125/200-55-2-12	250S-M	55	2900	N7	H140	125	150	3-400	90	1534	784	1470	353	668	280	140	1440	250	610	550	29	549
NOS125/200-75-2-12	280S-M	75	2900	N9	H160	125	150	3-400	90	1821	1071	1870	403	718	350	140	1840	320	730	670	29	1088
NOS125/200-90-2-12	280S-M	90	2900	N9	H160	125	150	3-400	90	1821	1071	1870	403	718	350	140	1840	320	730	670	29	1112
NOS125/200-110-2-12	315S-M	110	2900	N9	H160	125	150	3-400	90	1994	1244	1870	438	753	350	140	1840	320	730	670	29	1349

## DIMENSIONS – GROUPES – 2900 MIN-1 SANS SPACER

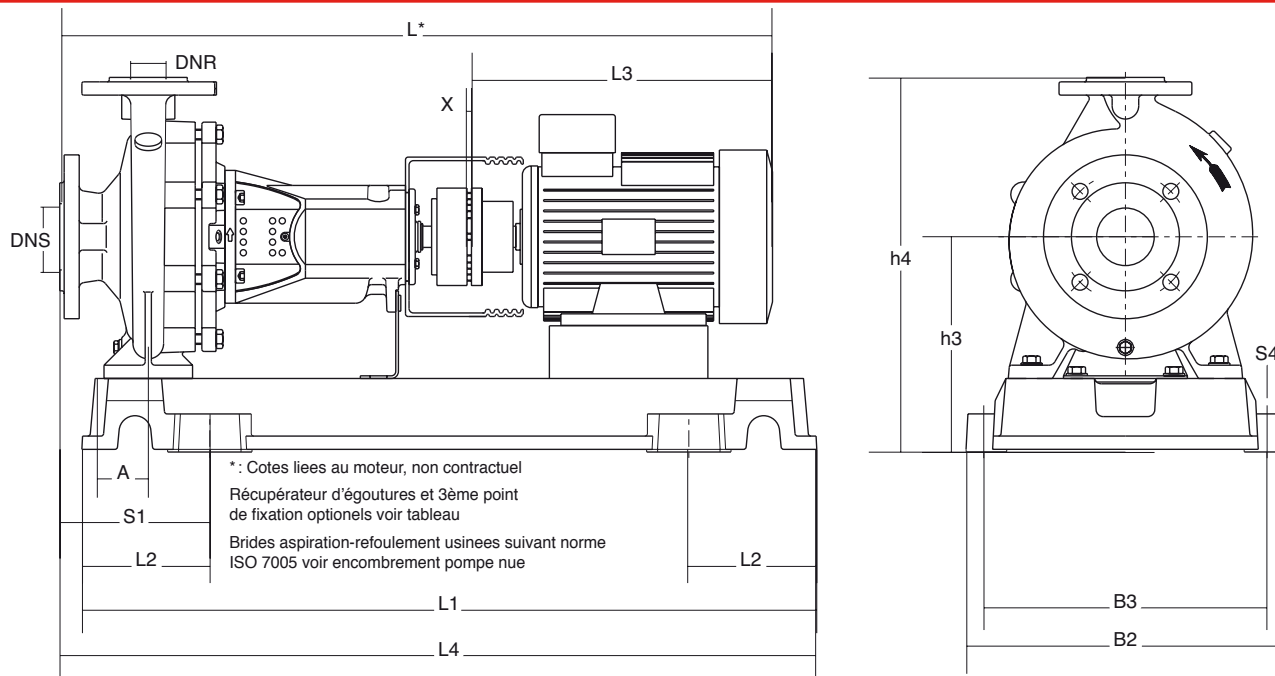

## DIMENSIONS – GROUPES – 2900 MIN-1 SANS SPACER

TYPE	Type de carcassee	Kw	min-1	Socle	Type accpt.	DNR	DNS	Tension	Groupe						Socle					Masse Net			
									A	L	L3	L4	h3	h4	S1	X	L1	L2	B2		B3	S4	
									mm	mm	mm	mm	mm	mm	mm	mm	mm	mm	mm	mm	mm	mm	kg
NOS32/125-0.55-2-05	71	0,55	2900	N2	B68	32	50	3-230-400	60	695,5	252,5	835	195	335	150	3	830	145	360	320	19	83	
NOS32/125-0.75-2-05	80	0,75	2900	N2	B68	32	50	3-230-400	60	726,5	283,5	835	195	335	150	3	830	145	360	320	19	87	
NOS32/125-1.1-2-05	80	1,1	2900	N2	B68	32	50	3-230-400	60	726,5	283,5	835	195	335	150	3	830	145	360	320	19	89	
NOS32/125-1.5-2-05	90S	1,5	2900	N2	B68	32	50	3-230-400	60	739,5	296,5	835	195	335	150	3	830	145	360	320	19	94	
NOS32/125-2.2-2-05	90L	2,2	2900	N2	B68	32	50	3-230-400	60	759,5	316,5	835	195	335	150	3	830	145	360	320	19	94	
NOS32/160-1.5-2-05	90S	1,5	2900	N2	B68	32	50	3-230-400	60	739,5	296,5	835	215	375	150	3	830	145	360	320	19	96	
NOS32/160-2.2-2-05	90L	2,2	2900	N2	B68	32	50	3-230-400	60	759,5	316,5	835	215	375	150	3	830	145	360	320	19	97	
NOS32/160-3-2-05	100L	3	2900	N2	B80	32	50	3-230-400	60	795	352	835	215	375	150	3	830	145	360	320	19	106	
NOS32/160-4-2-05	112M	4	2900	N2	B80	32	50	3-230-400	60	838,5	395,5	835	215	375	150	3	830	145	360	320	19	111	
NOS32/160-5.5-2-05	132S	5,5	2900	N2	B95	32	50	3-400	60	883,5	440,5	835	215	375	150	3	830	145	360	320	19	127	
NOS32/160B-1.5-2-05	90S	1,5	2900	N2	B68	32	50	3-230-400	60	739,5	296,5	835	215	375	150	3	830	145	360	320	19	96	
NOS32/160B-2.2-2-05	90L	2,2	2900	N2	B68	32	50	3-230-400	60	759,5	316,5	835	215	375	150	3	830	145	360	320	19	97	
NOS32/160B-3-2-05	100L	3	2900	N2	B80	32	50	3-230-400	60	795	352	835	215	375	150	3	830	145	360	320	19	106	
NOS32/160B-4-2-05	112M	4	2900	N2	B80	32	50	3-230-400	60	838,5	395,5	835	215	375	150	3	830	145	360	320	19	111	
NOS32/160B-5.5-2-05	132S	5,5	2900	N2	B95	32	50	3-400	60	883,5	440,5	835	215	375	150	3	830	145	360	320	19	127	
NOS32/200-2.2-2-05	90L	2,2	2900	N2	B68	32	50	3-230-400	60	759,5	316,5	835	243	423	150	3	830	145	360	320	19	105	
NOS32/200-3-2-05	100L	3	2900	N2	B80	32	50	3-230-400	60	795	352	835	243	423	150	3	830	145	360	320	19	112	
NOS32/200-4-2-05	112M	4	2900	N2	B80	32	50	3-230-400	60	838,5	395,5	835	243	423	150	3	830	145	360	320	19	116	
NOS32/200-5.5-2-05	132S	5,5	2900	N2	B95	32	50	3-400	60	883,5	440,5	835	243	423	150	3	830	145	360	320	19	131	
NOS32/200-7.5-2-05	132S	7,5	2900	N2	B95	32	50	3-400	60	883,5	440,5	835	243	423	150	3	830	145	360	320	19	137	
NOS32/200-9-2-05	132M	9	2900	N2	B95	32	50	3-400	60	918,5	475,5	835	243	423	150	3	830	145	360	320	19	136	
NOS32/200-11-2-05	160M	11	2900	N4	B95	32	50	3-400	60	1029	586	1035	263	443	190	3	1030	185	450	400	24	174	
NOS32/200B-2.2-2-05	90L	2,2	2900	N2	B68	32	50	3-230-400	60	759,5	316,5	835	243	423	150	3	830	145	360	320	19	105	
NOS32/200B-3-2-05	100L	3	2900	N2	B80	32	50	3-230-400	60	795	352	835	243	423	150	3	830	145	360	320	19	112	
NOS32/200B-4-2-05	112M	4	2900	N2	B80	32	50	3-230-400	60	838,5	395,5	835	243	423	150	3	830	145	360	320	19	116	
NOS32/200B-5.5-2-05	132S	5,5	2900	N2	B95	32	50	3-400	60	883,5	440,5	835	243	423	150	3	830	145	360	320	19	131	
NOS32/200B-7.5-2-05	132S	7,5	2900	N2	B95	32	50	3-400	60	883,5	440,5	835	243	423	150	3	830	145	360	320	19	137	
NOS32/200B-9-2-05	132M	9	2900	N2	B95	32	50	3-400	60	918,5	475,5	835	243	423	150	3	830	145	360	320	19	136	
NOS32/200B-11-2-05	160M	11	2900	N4	B95	32	50	3-400	60	1029	586	1035	263	443	190	3	1030	185	450	400	24	174	
NOS32/250-7.5-2-05	132S	7,5	2900	N4	B95	32	50	3-400	72,5	903,5	440,5	1042,5	283	508	197,5	3	1030	185	450	400	24	174	
NOS32/250-9-2-05	132M	9	2900	N4	B95	32	50	3-400	72,5	938,5	475,5	1042,5	283	508	197,5	3	1030	185	450	400	24	173	

## DIMENSIONS – GROUPES – 2900 MIN-1 SANS SPACER

TYPE	Type de carcasse	Kw	min-1	Socle	Type accept.	DNR	DNS	Tension	Groupe								Socle					Masse Net
									A	L	L3	L4	h3	h4	S1	X	L1	L2	B2	B3	S4	
									V	mm	mm	mm	mm	mm	mm	mm	mm	mm	mm	mm	mm	
NOS32/250-11-2-05	160M	11	2900	N4	B95	32	50	3-400	72,5	1049	586	1042,5	283	508	197,5	3	1030	185	450	400	24	191
NOS32/250-15-2-05	160M	15	2900	N4	B95	32	50	3-400	72,5	1049	586	1042,5	283	508	197,5	3	1030	185	450	400	24	203
NOS40/125-1.1-2-05	80	1,1	2900	N2	B68	40	65	3-230-400	60	726,5	283,5	835	195	335	150	3	830	145	360	320	19	86
NOS40/125-1.5-2-05	90S	1,5	2900	N2	B68	40	65	3-230-400	60	739,5	296,5	835	195	335	150	3	830	145	360	320	19	90
NOS40/125-2.2-2-05	90L	2,2	2900	N2	B68	40	65	3-230-400	60	759,5	316,5	835	195	335	150	3	830	145	360	320	19	91
NOS40/125-3-2-05	100L	3	2900	N2	B80	40	65	3-230-400	60	795	352	835	195	335	150	3	830	145	360	320	19	100
NOS40/160-2.2-2-05	90L	2,2	2900	N2	B68	40	65	3-230-400	60	759,5	316,5	835	215	375	150	3	830	145	360	320	19	94
NOS40/160-3-2-05	100L	3	2900	N2	B80	40	65	3-230-400	60	795	352	835	215	375	150	3	830	145	360	320	19	103
NOS40/160-4-2-05	112M	4	2900	N2	B80	40	65	3-230-400	60	838,5	395,5	835	215	375	150	3	830	145	360	320	19	108
NOS40/160-5.5-2-05	132S	5,5	2900	N2	B95	40	65	3-400	60	883,5	440,5	835	215	375	150	3	830	145	360	320	19	124
NOS40/160-7.5-2-05	132S	7,5	2900	N2	B95	40	65	3-400	60	883,5	440,5	835	215	375	150	3	830	145	360	320	19	130
NOS40/160-9-2-05	132M	9	2900	N2	B95	40	65	3-400	60	918,5	475,5	835	215	375	150	3	830	145	360	320	19	129
NOS40/200-5.5-2-05	132S	5,5	2900	N3	B95	40	65	3-400	60	903,5	440,5	955	243	423	190	3	930	165	390	350	19	143
NOS40/200-7.5-2-05	132S	7,5	2900	N3	B95	40	65	3-400	60	903,5	440,5	955	243	423	190	3	930	165	390	350	19	150
NOS40/200-9-2-05	132M	9	2900	N3	B95	40	65	3-400	60	938,5	475,5	955	243	423	190	3	930	165	390	350	19	149
NOS40/200-11-2-05	160M	11	2900	N4	B95	40	65	3-400	60	1049	586	1055	263	443	210	3	1030	185	450	400	24	176
NOS40/200-15-2-05	160M	15	2900	N4	B95	40	65	3-400	60	1049	586	1055	263	443	210	3	1030	185	450	400	24	189
NOS40/200-18.5-2-05	160L	18,5	2900	N4	B95	40	65	3-400	60	1049	586	1055	263	443	210	3	1030	185	450	400	24	199
NOS40/250-7.5-2-05	132S	7,5	2900	N4	B95	40	65	3-400	72,5	903,5	440,5	1042,5	283	508	197,5	3	1030	185	450	400	24	174
NOS40/250-9-2-05	132M	9	2900	N4	B95	40	65	3-400	72,5	938,5	475,5	1042,5	283	508	197,5	3	1030	185	450	400	24	173
NOS40/250-11-2-05	160M	11	2900	N4	B95	40	65	3-400	72,5	1049	586	1042,5	283	508	197,5	3	1030	185	450	400	24	191
NOS40/250-15-2-05	160M	15	2900	N4	B95	40	65	3-400	72,5	1049	586	1042,5	283	508	197,5	3	1030	185	450	400	24	203
NOS40/250-18.5-2-05	160L	18,5	2900	N4	B95	40	65	3-400	72,5	1049	586	1042,5	283	508	197,5	3	1030	185	450	400	24	213
NOS40/315-15-2-05	160M	15	2900	N5	B95	40	65	3-400	72,5	1184	586	1187,5	328	578	242,5	3	1150	205	490	440	24	273
NOS40/315-18.5-2-05	160L	18,5	2900	N5	B95	40	65	3-400	72,5	1184	586	1187,5	328	578	242,5	3	1150	205	490	440	24	284
NOS40/315-22-2-05	180M	22	2900	N5	B110	40	65	3-400	72,5	1227	629	1187,5	328	578	242,5	3	1150	205	490	440	24	302
NOS40/315-30-2-05	200L	30	2900	N6	B125	40	65	3-400	72,5	1263	665	1322,5	328	578	257,5	3	1290	225	540	490	24	367
NOS40/315-37-2-05	200L	37	2900	N6	B125	40	65	3-400	72,5	1263	665	1322,5	328	578	257,5	3	1290	225	540	490	24	400
NOS50/125-1.5-2-05	90S	1,5	2900	N2	B68	50	65	3-230-400	60	759,5	296,5	855	215	375	170	3	830	145	360	320	19	93
NOS50/125-2.2-2-05	90L	2,2	2900	N2	B68	50	65	3-230-400	60	779,5	316,5	855	215	375	170	3	830	145	360	320	19	94
NOS50/125-3-2-05	100L	3	2900	N2	B80	50	65	3-230-400	60	815	352	855	215	375	170	3	830	145	360	320	19	103
NOS50/125-4-2-05	112M	4	2900	N2	B80	50	65	3-230-400	60	858,5	395,5	855	215	375	170	3	830	145	360	320	19	108
NOS50/125-5.5-2-05	132S	5,5	2900	N2	B95	50	65	3-400	60	903,5	440,5	855	215	375	170	3	830	145	360	320	19	124
NOS50/160-3-2-05	100L	3	2900	N3	B80	50	65	3-230-400	60	815	352	955	243	423	190	3	930	165	390	350	19	125
NOS50/160-4-2-05	112M	4	2900	N3	B95	50	65	3-230-400	60	858,5	395,5	955	243	423	190	3	930	165	390	350	19	129
NOS50/160-5.5-2-05	132S	5,5	2900	N3	B95	50	65	3-400	60	903,5	440,5	955	243	423	190	3	930	165	390	350	19	143
NOS50/160-7.5-2-05	132S	7,5	2900	N3	B95	50	65	3-400	60	903,5	440,5	955	243	423	190	3	930	165	390	350	19	150
NOS50/160-9-2-05	132M	9	2900	N3	B95	50	65	3-400	60	938,5	475,5	955	243	423	190	3	930	165	390	350	19	149
NOS50/160-11-2-05	160M	11	2900	N4	B95	50	65	3-400	60	1049	586	1055	263	443	210	3	1030	185	450	400	24	176
NOS50/160-15-2-05	160M	15	2900	N4	B95	50	65	3-400	60	1049	586	1055	263	443	210	3	1030	185	450	400	24	189
NOS50/200-7.5-2-05	132S	7,5	2900	N3	B95	50	65	3-400	60	903,5	440,5	955	243	443	190	3	930	165	390	350	19	154
NOS50/200-9-2-05	132M	9	2900	N3	B95	50	65	3-400	60	938,5	475,5	955	243	443	190	3	930	165	390	350	19	153
NOS50/200-11-2-05	160M	11	2900	N4	B95	50	65	3-400	60	1049	586	1055	263	463	210	3	1030	185	450	400	24	180
NOS50/200-15-2-05	160M	15	2900	N4	B95	50	65	3-400	60	1049	586	1055	263	463	210	3	1030	185	450	400	24	193
NOS50/200-18.5-2-05	160L	18,5	2900	N4	B95	50	65	3-400	60	1049	586	1055	263	463	210	3	1030	185	450	400	24	203
NOS50/200-22-2-05	180M	22	2900	N4	B110	50	65	3-400	60	1092	629	1055	283	483	210	3	1030	185	450	400	24	229
NOS50/250-11-2-05	160M	11	2900	N4	B95	50	65	3-400	72,5	1049	586	1042,5	283	508	197,5	3	1030	185	450	400	24	195
NOS50/250-15-2-05	160M	15	2900	N4	B95	50	65	3-400	72,5	1049	586	1042,5	283	508	197,5	3	1030	185	450	400	24	207
NOS50/250-18.5-2-05	160L	18,5	2900	N4	B95	50	65	3-400	72,5	1049	586	1042,5	283	508	197,5	3	1030	185	450	400	24	217
NOS50/250-22-2-05	180M	22	2900	N4	B110	50	65	3-400	72,5	1092	629	1042,5	283	508	197,5	3	1030	185	450	400	24	235
NOS50/250-30-2-05	200L	30	2900	N6	B125	50	65	3-400	72,5	1128	665	1297,5	303	528	232,5	3	1290	225	540	490	24	343
NOS50/315-15-2-05	160M	15	2900	N5	B95	50	65	3-400	72,5	1184	586	1187,5	328	608	242,5	3	1150	205	490	440	24	289
NOS50/315-18.5-2-05	160L	18,5	2900	N5	B95	50	65	3-400	72,5	1184	586	1187,5	328	608	242,5	3	1150	205	490	440	24	299
NOS50/315-22-2-05	180M	22	2900	N5	B110	50	65	3-400	72,5	1227	629	1187,5	328	608	242,5	3	1150	205	490	440	24	317
NOS50/315-30-2-05	200L	30	2900	N6	B125	50	65	3-400	72,5	1263	665	1322,5	328	608	257,5	3	1290	225	540	490	24	383
NOS50/315-37-2-05	200L	37	2900	N6	B125	50	65	3-400	72,5	1263	665	1322,5	328	608	257,5	3	1290	225	540	490	24	416
NOS50/315-45-2-05	225S-M	45	2900	N6	B125	50	65	3-400	72,5	1333	735	1322,5	328	608	257,5	3	1290	225	540	490	24	482
NOS50/315-55-2-05	250S-M	55	2900	N7	B140	50	65	3-400	72,5	1382	784	1472,5	353	633	282,5	3	1440	250	610	550	29	538

## DIMENSIONS – GROUPES – 2900 MIN-1 SANS SPACER

TYPE	Type de carcasse	Kw	min-1	Socle	Type accept.	DNR	DNS	Tension	Groupe								Socle					Masse Net
									A	L	L3	L4	h3	h4	S1	X	L1	L2	B2	B3	S4	
									V	mm	mm	mm	mm	mm	mm	mm	mm	mm	mm	mm	mm	
NOS50/315-75-2-05	280S-M	75	2900	N9	B160	50	65	3-400	72,5	1669	1071	1872,5	403	683	352,5	3	1840	320	730	670	29	1073
NOS65/125-3-2-05	100L	3	2900	N3	B80	65	80	3-230-400	72,5	815	352	942,5	243	423	177,5	3	930	165	390	350	19	122
NOS65/125-4-2-05	112M	4	2900	N3	B80	65	80	3-230-400	72,5	903,5	395,5	942,5	243	423	177,5	3	930	165	390	350	19	125
NOS65/125-5-5-2-05	132S	5,5	2900	N3	B95	65	80	3-400	72,5	903,5	440,5	942,5	243	423	177,5	3	930	165	390	350	19	140
NOS65/125-7-5-2-05	132S	7,5	2900	N3	B95	65	80	3-400	72,5	903,5	440,5	942,5	243	423	177,5	3	930	165	390	350	19	147
NOS65/125-9-2-05	132M	9	2900	N3	B95	65	80	3-400	72,5	938,5	475,5	942,5	243	423	177,5	3	930	165	390	350	19	146
NOS65/160-5-5-2-05	132S	5,5	2900	N3	B95	65	80	3-400	72,5	903,5	440,5	942,5	243	443	177,5	3	930	165	390	350	19	147
NOS65/160-7-5-2-05	132S	7,5	2900	N3	B95	65	80	3-400	72,5	903,5	440,5	942,5	243	443	177,5	3	930	165	390	350	19	153
NOS65/160-9-2-05	132M	9	2900	N3	B95	65	80	3-400	72,5	938,5	475,5	942,5	243	443	177,5	3	930	165	390	350	19	152
NOS65/160-11-2-05	160M	11	2900	N4	B95	65	80	3-400	72,5	1049	586	1042,5	263	463	197,5	3	1030	185	450	400	24	179
NOS65/160-15-2-05	160M	15	2900	N4	B95	65	80	3-400	72,5	1049	586	1042,5	263	463	197,5	3	1030	185	450	400	24	192
NOS65/160-18-5-2-05	160L	18,5	2900	N4	B95	65	80	3-400	72,5	1049	586	1042,5	263	463	197,5	3	1030	185	450	400	24	202
NOS65/200-9-2-05	132M	9	2900	N4	B95	65	80	3-400	72,5	938,5	475,5	1042,5	283	508	197,5	3	1030	185	450	400	24	172
NOS65/200-11-2-05	160M	11	2900	N4	B95	65	80	3-400	72,5	1049	586	1042,5	283	508	197,5	3	1030	185	450	400	24	190
NOS65/200-15-2-05	160M	15	2900	N4	B95	65	80	3-400	72,5	1049	586	1042,5	283	508	197,5	3	1030	185	450	400	24	202
NOS65/200-18-5-2-05	160L	18,5	2900	N4	B95	65	80	3-400	72,5	1049	586	1042,5	283	508	197,5	3	1030	185	450	400	24	212
NOS65/200-22-2-05	180M	22	2900	N4	B110	65	80	3-400	72,5	1092	629	1042,5	283	508	197,5	3	1030	185	450	400	24	230
NOS65/200-30-2-05	200L	30	2900	N6	B125	65	80	3-400	72,5	1128	665	1297,5	303	528	232,5	3	1290	225	540	490	24	338
NOS65/250-18-5-2-05	160L	18,5	2900	N5	B95	65	80	3-400	90	1159	586	1145	303	553	200	3	1150	205	490	440	24	276
NOS65/250-22-2-05	180M	22	2900	N5	B110	65	80	3-400	90	1202	629	1145	303	553	200	3	1150	205	490	440	24	294
NOS65/250-30-2-05	200L	30	2900	N6	B125	65	80	3-400	90	1238	665	1280	303	553	215	3	1290	225	540	490	24	359
NOS65/250-37-2-05	200L	37	2900	N6	B125	65	80	3-400	90	1238	665	1280	303	553	215	3	1290	225	540	490	24	392
NOS65/250-45-2-05	225S-M	45	2900	N6	B125	65	80	3-400	90	1308	735	1280	328	578	215	3	1290	225	540	490	24	471
NOS80/160-7-5-2-05	132S	7,5	2900	N4	B95	80	100	3-400	72,5	928,5	440,5	1067,5	283	508	222,5	3	1030	185	450	400	24	171
NOS80/160-9-2-05	132M	9	2900	N4	B95	80	100	3-400	72,5	963,5	475,5	1067,5	283	508	222,5	3	1030	185	450	400	24	170
NOS80/160-11-2-05	160M	11	2900	N4	B95	80	100	3-400	72,5	1074	586	1067,5	283	508	222,5	3	1030	185	450	400	24	188
NOS80/160-15-2-05	160M	15	2900	N4	B95	80	100	3-400	72,5	1074	586	1067,5	283	508	222,5	3	1030	185	450	400	24	200
NOS80/160-18-5-2-05	160L	18,5	2900	N4	B95	80	100	3-400	72,5	1074	586	1067,5	283	508	222,5	3	1030	185	450	400	24	210
NOS80/160-22-2-05	180M	22	2900	N4	B110	80	100	3-400	72,5	1117	629	1067,5	283	508	222,5	3	1030	185	450	400	24	228
NOS80/160-30-2-05	200L	30	2900	N6	B125	80	100	3-400	72,5	1153	665	1322,5	303	528	257,5	3	1290	225	540	490	24	336
NOS80/200-15-2-05	160M	15	2900	N5	B95	80	100	3-400	72,5	1184	586	1187,5	283	533	242,5	3	1150	205	490	440	24	251
NOS80/200-18-5-2-05	160L	18,5	2900	N5	B95	80	100	3-400	72,5	1184	586	1187,5	283	533	242,5	3	1150	205	490	440	24	262
NOS80/200-22-2-05	180M	22	2900	N5	B110	80	100	3-400	72,5	1227	629	1187,5	283	533	242,5	3	1150	205	490	440	24	280
NOS80/200-30-2-05	200L	30	2900	N6	B125	80	100	3-400	72,5	1263	665	1322,5	303	553	257,5	3	1290	225	540	490	24	353
NOS80/200-37-2-05	200L	37	2900	N6	B125	80	100	3-400	72,5	1263	665	1322,5	303	553	257,5	3	1290	225	540	490	24	386
NOS80/200-45-2-05	225S-M	45	2900	N6	B125	80	100	3-400	72,5	1333	735	1322,5	328	578	257,5	3	1290	225	540	490	24	464
NOS80/250-22-2-05	180M	22	2900	N6	B110	80	100	3-400	90	1227	629	1305	303	583	240	3	1290	225	540	490	24	330
NOS80/250-30-2-05	200L	30	2900	N6	B125	80	100	3-400	90	1263	665	1305	303	583	240	3	1290	225	540	490	24	364
NOS80/250-37-2-05	200L	37	2900	N6	B125	80	100	3-400	90	1263	665	1305	303	583	240	3	1290	225	540	490	24	397
NOS80/250-45-2-05	225S-M	45	2900	N6	B125	80	100	3-400	90	1333	735	1305	328	608	240	3	1290	225	540	490	24	476
NOS80/250-55-2-05	250S-M	55	2900	N7	B140	80	100	3-400	90	1382	784	1455	353	633	265	3	1440	250	610	550	29	535
NOS100/160-18-5-2-05	160L	18,5	2900	N5	B95	100	125	3-400	90	1184	586	1170	303	583	225	3	1150	205	490	440	24	284
NOS100/160-22-2-05	180M	22	2900	N5	B110	100	125	3-400	90	1227	629	1170	303	583	225	3	1150	205	490	440	24	302
NOS100/160-30-2-05	200L	30	2900	N6	B125	100	125	3-400	90	1263	665	1305	303	583	240	3	1290	225	540	490	24	367
NOS100/160-37-2-05	200L	37	2900	N6	B125	100	125	3-400	90	1263	665	1305	303	583	240	3	1290	225	540	490	24	400
NOS100/200-18-5-2-05	160L	18,5	2900	N5	B95	100	125	3-400	90	1184	586	1170	303	583	225	3	1150	205	490	440	24	276
NOS100/200-22-2-05	180M	22	2900	N5	B110	100	125	3-400	90	1227	629	1170	303	583	225	3	1150	205	490	440	24	294
NOS100/200-30-2-05	200L	30	2900	N6	B125	100	125	3-400	90	1263	665	1305	303	583	240	3	1290	225	540	490	24	359
NOS100/200-37-2-05	200L	37	2900	N6	B125	100	125	3-400	90	1263	665	1305	303	583	240	3	1290	225	540	490	24	392
NOS100/200-45-2-05	225S-M	45	2900	N6	B125	100	125	3-400	90	1333	735	1305	328	608	240	3	1290	225	540	490	24	471
NOS100/250-30-2-05	200L	30	2900	N6	B125	100	125	3-400	90	1278	665	1320	328	608	255	3	1290	225	540	490	24	380
NOS100/250-37-2-05	200L	37	2900	N6	B125	100	125	3-400	90	1278	665	1320	328	608	255	3	1290	225	540	490	24	412
NOS100/250-45-2-05	225S-M	45	2900	N6	B125	100	125	3-400	90	1348	735	1320	328	608	255	3	1290	225	540	490	24	479
NOS100/250-55-2-05	250S-M	55	2900	N7	B140	100	125	3-400	90	1397	784	1470	353	633	280	3	1440	250	610	550	29	537
NOS100/250-75-2-05	280S-M	75	2900	N9	B160	100	125	3-400	90	1684	1071	1870	403	683	350	3	1840	320	730	670	29	1073
NOS100/250-90-2-05	280S-M	90	2900	N9	B160	100	125	3-400	90	1684	1071	1870	403	683	350	3	1840	320	730	670	29	1097
NOS125/200-55-2-05	250S-M	55	2900	N7	B140	125	150	3-400	90	1397	784	1470	353	668	280	3	1440	250	610	550	29	544
NOS125/200-75-2-05	280S-M	75	2900	N9	B160	125	150	3-400	90	1684	1071	1870	403	718	350	3	1840	320	730	670	29	1082
NOS125/200-90-2-05	280S-M	90	2900																			