

Accessories guide



Accessories Part No

Low Suction Collars

Micro, Mini (Macro)	5096800
Minex (version 160,172)	5178101
Minex (version 171)	5065300
Minette (version 171,172)	5114300
Minor, Major (version 180,181)	5117000



Zinc Anode Kits

Minex, Minette (version 160,172)	5173600
Minex, Minette (version 171)	5107700
Minor, Major (version 180,181)	5107900
Master N/H/SH (version 181,182)	5108000
Master SH* (version 180)	132895
Matador (version 180,181)	5108100

Maxi	132898
Magnum	5055601
Mega N	5111700
Mega H	5111701
Salvador (version 281,282)	5109500
Senior, Sandy (version 280,281)	5109600

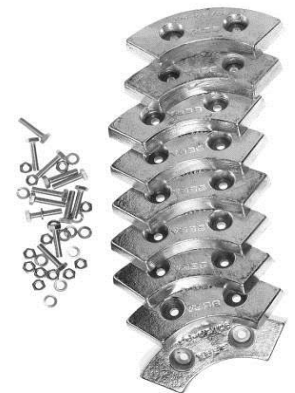

Minette Inox	132894
Major Inox *	132895
Master Inox *	132895
Salvador Inox	132894
Senior Inox	132895
Sandy Inox	132895

Bravo 200/300 drive unit	5160200
Bravo 200/300 hydraulic unit	5160201
Bravo 400 drive unit	5160300
Bravo 400 hydraulic unit	5160304
Bravo 500/600 drive unit	5160301
Bravo 500/600 hydraulic unit	5160304
Bravo 700/800 drive unit	5160302
Bravo 700/800 hydraulic unit	5160305
Bravo 900 drive unit	5160303
Bravo 900 hydraulic unit	5160305

* Must be used in combination with base plate 140012RF.

Stand

Mega N (H)	5121200
------------	---------

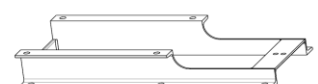

Accessories guide



Accessories

Part No



Tandem connection kits

Minor N*, Major N*	5112500
Minor H*, Major H*	5112501
Master N*/H*/SH* (version 181,182)	5112501
Master SH (version 180, Proline, not according to picture)	5043101
Matador N*	5112503
Matador H*	5112502
Maxi N 6"	132445
Maxi ISO G6	132446
Maxi N NPT 6-8	132447
Maxi N 8"	132448
Maxi N ISO G8	132449
Maxi N NPT 8-8	132450
Maxi H ISO G4	132440
Maxi H NPSM 4-8	5111400
Magnum H 6"	5055700
Magnum H NPT 6-8	5055701

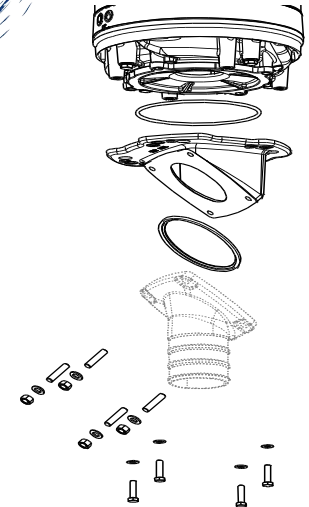

* Must be used in combination with discharge connection mounted on the adapter (discharge not included in kit).

Level regulator kits Micro, Mini (ver.211), Solid (ver.281)

1 ph -Max 250V CE approved	5166500
1 ph -Max 250V CSA approved	5166501

Level regulator kits Minex(ver.160/172),Minette(ver.172),Minor-Major(ver.181), Salvador(ver.282),Senior-Sandy(ver.281)***

3-ph -Max 400V CE approved	5172604
1-3 ph -Max 250V (or with 24V circuit)CE approved	5172603
1-3 ph -Max 250V (or with 24V circuit)CSA approved	5172605

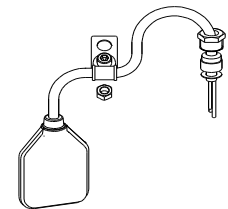

Level regulator kits Master(ver.182)Matador(ver.181)***

3-ph -Max 400V CE approved	5172608
3-ph -Max 250V eller 24V krets CE approved	5172606
3-ph -Max 250V eller 24V krets CSA approved	5172607

*** For 24V level regulator control circuit order surveillance relay separate.

Surveillance relay for built in level regulator for 24V.	5177900
--	---------

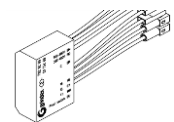

Note! For local assembly of level regulator, order cover separate, see list below

Minex ver.160/172	5168601
Minette,Salvador ver.172/282	5168701
Minor,Major ver.181, Senior, Sandy ver.281	5176101
Master ver.182	5086201
Matador ver.181	5099401



Level regulator kits - OLD VERSIONS

Minex-Minette (ver.171), Minor-Major(ver.180),Salvador(ver.281), Senior, Sandy(ver.280)

1- & 3-Phase - Max 400V CE approved	5115500
1- & 3-Phase - Max 250V or 24V* control circuit CE approved	5115501
1- & 3-Phase - Max 250V or 24V* control circuit CSA approved	5115502

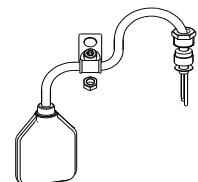

* For 24V level regulator control order transformer and contactor separate according spare part list for pump model.

Accessories guide

Accessories

Part No

Level regulator, 1-Phase - OLD VERSIONS

CE - Micro, Macro (ver. 210), Solid (ver. 280), or Minex,
Minette*, Salvador* with lower serial no than 1159999
CSA - Micro, Macro (ver. 210), Solid (ver. 280), or Minex,
Minette*, Salvador* with lower serial no than 1159999
Contact plug including cables for 5093700, -01

5093700

5093701

5093600



* Main cover 5116701 required for pumps with serial number lower than 1070001.

External level control boxes - up to 37 A with one level regulator*, 10m

400V 50 Hz, rated current 16A, with 16A Europlug
400V 50 Hz, rated current 25A, with 32A Europlug
400V 50 Hz, rated current 32A, with 32A Europlug
400V 50 Hz, rated current 37A, with 63A Europlug
230,400V 50-60 Hz, rated current 16A
230,400V 50-60 Hz, rated current 25A
230,400V 50-60 Hz, rated current 32A
230,400V 50-60 Hz, rated current 37A
415-660V 50-60 Hz, rated current 16A
415-660V 50-60 Hz, rated current 25A
415-660V 50-60 Hz, rated current 32A
415-660V 50-60 Hz, rated current 37A

5112600

5112601

5112602

5112603

5112604

5112605

5112606

5112607

5112700

5112701

5112702

5112703



*Optional, two level regulators (start and stop).

Level regulators

Level regulator 10m cable for external level control box
Level regulator 0,75m cable for pump Max 400V CE(1-3 ph)
Level regulator 0,75m cable for pump Max 250V/24V CE(1-3 ph)
Level regulator 0,75m cable for pump Max 250V/24V CSA(1-3ph)*

131621

5017600

410774

410775



CEE Plugs - 400V

Europlug with phase shifter 16A (3P+N+PE)
Europlug with phase shifter 32A (3P+N+PE)
Europlug 63A (3P+N+PE)
Europlug 125A (3P+N+PE)

5010000

5010001

132195

132309

Europlug 16A (3P+PE)

410684

Europlug 32A (3P+PE)

410685



CEE Plugs - 500V

Europlug 16A (3P+PE)
Europlug 32A (3P+PE)

5010010

5010011

Phase shifters

16A, 220-575V
22A, 220-575V
48A, 220-575V

5010200

5010201

5010202



Accessories guide



Accessories

Part No

Starter 6-32A DOL 50Hz with CEE plug

6-32A, Overload relay & pilot cable connection for temperature guard

6-10A 380-415V/CEE16	410804
9-14A 380-415V/CEE16 for Bravo 200/300 400V50	410805
13-18A 380-415V/CEE16	410806
9-14A 380-415V/CEE32 for Bravo 200/300 400V50	410807
17-23A 380-415V/CEE32	410808
24-32A 380-415V/CEE32 for Bravo 400 DOL 400V50	410809



Starter 6-32A DOL 50/60Hz with cable glands for pump/power cable

6-32A, Overload relay & pilot cable connection for temperature guard

17-23A 230V/cable connections	410802
24-32A 230V/cable connections	410803

6-10A 380-415V/cable connections	5076601
9-14A 380-415V/cable connections for Bravo 200/300 400V50	410795
13-18A 380-415V/cable connections	410796
24-32A 380-415V/cable connections for Bravo 400 400V50	410797



6-10A 460-500V/cable connections for Bravo 200/300 500V50	5076603
9-14A 460-500V/cable connections for Bravo 200/300 460V60	410799
13-18A 460-500V/cable connections	410800
24-32A 460-500V/cable connections for Bravo 400/500 460V60	410801

Starter Panels GSP D32-D100 for Bravo & Maxi pumps

22-100 A, multi voltage 230-500V 50/60Hz for DOL start, IP55

GSP-D32, 22-32A DOL for Bravo 400 400V50, 460V60	5163100
GSP-D40, 28-40A DOL for Bravo 500 400V50, 460V60	5163101
GSP-D50, 40-50A DOL for Bravo 600 400V50, 460V60	5163102
GSP-D63, 45-63A DOL for Maxi 500V50	5163103
GSP-D75, 57-75A DOL for Maxi, Bravo 700 400V50, 460V60	5163104
GSP-D90, 70-90A DOL for Bravo 800 400V50, 460V60	5163105
GSP-D100, 80-100A DOL for Magnum H 400V50, 460V60	5163106



Starter Panels GSP Y32-D100 for Bravo & Maxi pumps

22-100 A, multi voltage 230-500V 50/60Hz for Star-Delta start, IP55

GSP-Y32, 22-32A Y/D for Bravo 400 400V50, 460V60	5163200
GSP-Y40, 28-40A Y/D for Bravo 500 400V50, 460V60	5163201
GSP-Y50, 40-50A Y/D for Bravo 600 400V50, 460V60	5163202
GSP-Y63, 45-63A Y/D for Maxi 500V50	5163203
GSP-Y75, 57-75A Y/D for Maxi, Bravo 700 400V50, 460V60	5163204
GSP-Y90, 70-90A Y/D for Bravo 800 400V50, 460V60	5163205
GSP-Y100, 80-100A Y/D for Magnum H 400V50, 460V60	5163206



Option. For level control with GSP 32-100 add separate start & stop level regulators for two regulator system (see below). Other configurations on request.

Starter Panels GSP D110-D185 for Magnum , Bravo & Mega pumps

100-185 A, multi voltage 230-500V 50/60Hz for DOL start, IP55.

GSP-D110H*, 100-110A DOL for Magnum N/L 400V50, 460V60	5163107
GSP-D140H*, 110-140A DOL	5163108
GSP-D170H*, 130-170A DOL	5163109
GSP-D185H*, 170-185A DOL	5163110

GSP-D110E*, 100-110A DOL	5163117
GSP-D140E*, 110-140A DOL for Bravo 900 400V50, 460V60	5163118
GSP-D170E*, 130-170A DOL for Mega 400V50, 460V60	5163119
GSP-D185E*, 170-185A DOL	5163120

H* = MICS II/A-meter E* = MICS II/A-meter/PT 100 relay



Accessories guide

Accessories

Part No

Starter Panels GSP Y110-Y185 for Magnum , Bravo & Mega pumps
100-185 A, multi voltage 230-500V 50/60Hz for Star-Delta start, IP55

GSP-Y110H*, 100-110A Y/D for Magnum N/L 400V50, 460V60	5163207
GSP-Y140H*, 110-140A Y/D	5163208
GSP-Y170H*, 130-170A Y/D	5163209
GSP-Y185H*, 170-185A Y/D	5163210

GSP-Y110E*, 100-110A Y/D	5163217
GSP-Y140E*, 110-140A Y/D for Bravo 900 400V50, 460V60	5163218
GSP-Y170E*, 130-170A Y/D for Mega 400V50, 460V60	5163219
GSP-Y185E*, 170-185A Y/D	5163220

H* = MICS II/A-meter E* = MICS II/A-meter/PT 100 relay



Option. For level control with GSP 110-185 add separate start & stop level regulators and for high level alarm add separate level regulator for two regulator system (see below). Other configurations on request.

Level regulators for Starter Panels GSP 32-185

Level regulator 6m cable, only for two regulator system	131539
Level regulator 13m cable, only for two regulator system	131540
Level regulator 20m cable, only for two regulator system	131541
Level regulator 50m cable, only for two regulator system	410827



Pump raft

Raft for Micro, Mini and Minex (lifting capacity 25 kg)	410391
Raft for Minette, Minor and Major (lifting capacity 55 kg)	410392



Pump raft system 80-600 & 1150 , complete units selected
for grindex dewatering pumps

Pump raft system 80, lifting capacity 80 kg	410712
Pump raft system 180, lifting capacity 180 kg	410713
Pump raft system 460, lifting capacity 460 kg	410714
Pump raft system 600, lifting capacity 600 kg	410715
Pump raft system 1150*, lifting capacity 1150 kg	5180500
Bracket used for Bravo pumps on model 1150	5108600



Individual parts to build systems
(for bill of materials please check accessory leaflet)

Pump Raft M100 (ring)	410467
Pump Raft M170 (block)	410468
Pump lifting frame	410648
Lifting chain	410649
Screws for pumplifting frame, kit	410650
Lifting eye bolts, kit	410651
Connection part 1/4	410652
Connection part 1/4 with eye bolt	410653
Connection part 2/4	410654
Connection part 3/4	410655
Connection part 4/4	410656
Threaded rods M8 125mm, kit	410657
Threaded rods M8 260mm, kit	410658
Threaded rods M8 390mm, kit	410659
Threaded rods M8 525mm, kit	410660
Tool kit for assembly	410661

*

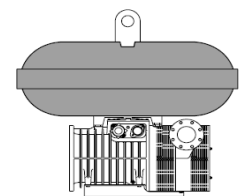

Accessories guide

Accessories

Part No

PolyPump Ltd

Providing your pumping solutions

 sales@polypump.co.uk
 01296 488 294

Power cables (units in meter)

3G1.5mm ² (Ø 10-11 mm)	131042
4G1.5mm ² (Ø 10,5-11,5 mm)	131040
4G2.5mm ² (Ø 12,5-13,5 mm)	131039
7G2.5mm ² (Ø 18-20 mm)___see 410063*	410647
4G4mm ² (Ø 16-17 mm)	133139
4G6mm ² (Ø 18-19 mm)	131028
4G10mm ² (Ø 23,5-25,5 mm)___see 410852*	131027
4G16mm ² (Ø 26-28 mm)___see 410853*	131026
4G25mm ² (Ø 32,5-34,5 mm)___see 410854*	132460
4G35mm ² (Ø 36,5-38,5 mm)___see 410855*	132458
4G50mm ² (Ø 41-45 mm)___see 410856*	410353
4G70mm ² (Ø 45-49 mm)___see 410857	410354

* replaced with Power cables with control cores see below

Power cables with control cores (units in meter)

4G1.5mm ² + 2x1.5mm ² (Ø 15-16 mm)	410062
4G2.5mm ² + 2x1.5mm ² (Ø 17-18 mm)	5077700
7G2.5mm ² + 2x1.5mm ² (Ø 20-23 mm)	410063
4G4mm ² + 2x1.5mm ² (Ø 20-22 mm)	410129
7G4mm ² + 2x1.5mm ² (Ø 22-26 mm)	410130
4G6mm ² + 2x1.5mm ² (Ø 23-25 mm)	410126
7G6mm ² + S(2x0.5)mm ² (Ø 24-26 mm)	410858
4G10mm ² + S(2x0.5)mm ² (Ø 24-26 mm)	410852
4G16mm ² + S(2x0.5)mm ² (Ø 26-28 mm)	410853
4G25mm ² + S(2x0.5)mm ² (Ø 32-34 mm)	410854
4G35mm ² + S(2x0.5)mm ² (Ø 35-37 mm)	410855
3G50mm ² + 2G25/2 + S(2x0.5)mm ² (Ø 35-37 mm)	410856
3G70mm ² + 2G35/2 + S(2x0.5)mm ² (Ø 38-41 mm)	410857

AWG power cables (units in meter)

14 AWG/3 (Ø 13,2-14,2 mm)	410064
14 AWG/4 (Ø 14,2-15,2 mm)	410065
14 AWG/7 (Ø 18-20 mm)	410066
12 AWG/4 (Ø 17-18 mm)	410067
12 AWG/7 (Ø 20-22 mm)	410068
10 AWG/4 (Ø 18-19,7 mm)	410132
8 AWG/4 (Ø 24-26 mm)	410133

AWG power cables with control cores (units in meter)

10 AWG/3-2-1-GC (Ø 20,3-22,3 mm)	410069
8 AWG/3-2-1-GC (Ø 27,2-29,2 mm)	410134
6 AWG/3-2-1-GC (Ø 30-32 mm)	410135
4 AWG/3-2-1-GC (Ø 32,8-34,8 mm)	410136
1 AWG/3-2-1-GC (Ø 40,7-42,7 mm)	410355

Screened power cables (units in meter)

S3x1.5mm (Ø 13,5-14,9 mm)	410058
S3x2.5mm (Ø 13,5-14,9 mm)	410059
S3x1.5mm ² + 3x0.5/3 + S(2x0.5)mm ² (Ø 16-17 mm)	410859
S3x2.5mm ² + 3x2.5/3 + S(4x0.5)mm ² (Ø 18-20 mm)	410860
S3x6mm ² + 3x6/3 + S(4x0.5)mm ² (Ø 20-22 mm)	410861
S3x10mm ² + 3x10/3 + S(4x0.5)mm ² (Ø 24-26 mm)	410862
S3x16mm ² + 3x16/3 + S(4x0.5)mm ² (Ø 24-26 mm)	410863
S3x25mm ² + 3x16/3 + S(4x0.5)mm ² (Ø 29-31 mm)	410864
S3x35mm ² + 3x16/3 + S(4x0.5)mm ² (Ø 32-34 mm)	410865
S3x50mm ² + 3x25/3 + S(4x0.5)mm ² (Ø 38-40 mm)	410866
S3x70mm ² + 3x35/3 + S(4x0.5)mm ² (Ø 42-44 mm)	410867

Control cables (units in meter)

2x1.5mm ² (Ø 10-11 mm)	130963
7x1.5mm ² (Ø 15-17 mm)	410350

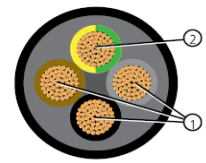

4 G X
 1. Motor cores
 2. Ground core, green/yellow

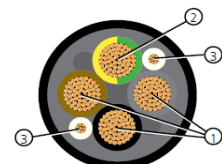

4 G X + 2x1,5
 1. Motor cores
 2. Ground core, green/yellow
 3. Control cores, creme white, T1, T2



4 G X + S(2x0.5)



3 G X 2 G X + S(2x0.5)

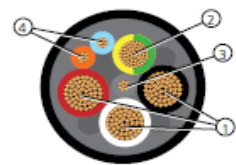

x AWG/3-2-1-GC
 1. Motor cores
 2. Ground core
 3. GC: Ground check core
 4. Control cores, blue, orange



S 3 G X 3 G X/3 + S(4x0.5)

Accessories guide



Accessories

Part No

Quick couplings

Storz ISO G2", DN52 PN16 Aluminium	410027
Storz ISO G3", DN75 PN16 Aluminium	410028
Storz ISO G4", DN100 PN16 Aluminium	410029
Storz ISO G6", DN150 PN16 Aluminium (with 3 catches)	410099
Storz for hose 2", DN52 PN16 Aluminium	410312
Storz for hose 3", DN75 PN16 Aluminium	410311
Storz for hose 4", DN100 PN16 Aluminium	410783
Storz for hose 6", DN150 PN16 Aluminium (with 3 catches)	410294

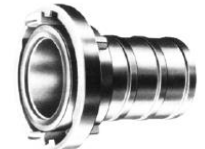

Check valve in aluminium

Threaded ISO G2", inner to outer thread, PN 16	410314
Threaded ISO G3", inner to outer thread, PN 16	410315
Threaded ISO G4", inner to outer thread, PN 16	410316

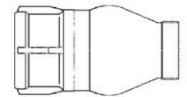

Flap check valve in epoxy resin coated cast iron

Flange DN 100, PN 16, (DIN 2501)	410469
Flange DN 150, PN 16, (DIN 2501)	410472
Flange DN 200, PN 10, (DIN 2501)	410473
Flange DN 250, PN 10, (DIN 2501)	410474



Gate valve for flange connection in epoxy coated ductile iron

Flange DN 100, PN 10/16, (DIN 2501)	410847
Flange DN 150, PN 10/16, (DIN 2501)	410849

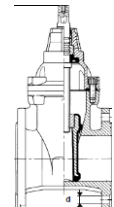

Gasket for flange connections in rubber bonded fiber

Flange DN 100, PN 10, (DIN 2501)	410848
Flange DN 150, PN 10, (DIN 2501)	410850

Coupling (to flap check valve and victaulic kits)

Hose to flange, 4" DN100, PN10/16 (DIN EN 1092-1)	410746
Hose to flange, 6" DN150, PN10/16 (DIN EN 1092-1)	410747



4" Victaulic flange kit for Bravo 400-600

Coupling Hose to flange, 4" DN100, PN10/16 (DIN EN 1092-1)	410746
Victaulic flanges 4" DN100, PN16	410675
Victaulic bend 4" in thermoplastic coated steel	410676
Victaulic couplings 4"	410677
Screw M16X70-A2-70, ISO 4017 (4"), 8 Pcs per flange	410754
Nut M16-A2-70 (4"), 8 Pcs per flange	132256
Washer M16-A2-70 (4"), 8 Pcs per flange	132258



6" Victaulic flange kit for Bravo 700-900

Tot kit	
Coupling Hose to flange, 6" DN150, PN10/16 (DIN EN 1092-1)	410747
Victaulic flanges 6" DN150, PN16	410678
Victaulic bend 6" in thermoplastic coated steel	410679
Victaulic couplings 6"	410680
Screw M20X80-A2-70, ISO 4017 (6"), 8 Pcs per flange	410755
Nut M20-A2-70 (6"), 8 Pcs per flange	5002500
Washer M20-A2-70 (6"), 8 Pcs per flange	5002502



Hose & Hose clamps are available on request

Test equipment which fits hose 2", 3" and 4". Range 0-6 bar (0-60 mvp)

Gauge unit for testing pump pressure,	114422
---------------------------------------	--------

