



Japanese Technology since 1912

## Model GS - Standardised end suction pumps

Data Book 50Hz







**Japanese Technology since 1912**

[www.ebara-europe.com](http://www.ebara-europe.com)



## INDEX

**SPECIFICATION**

Main Applications	6
General Description and Main Features	7
Type key	8
Nameplate	9
Applicable model	10

**CONSTRUCTION**

Sectional View (Mechanical Seal Type)	11
Sectional View (Gland Packing Type)	12
Materials of Constructions	13
Availability of Materials	14

**TECHNICAL DATA**

Impeller diameter	15
Nominal Dimensions of Parts	16
Selection of Shaft Seal	17

**DIMENSIONS**

GS 2900min <sup>-1</sup>	18
GS 1450min <sup>-1</sup>	23
Bare Shaft Pump	28

**SELECTION CHART**

GS 2900min <sup>-1</sup>	31
GS 1450min <sup>-1</sup>	36



**PERFORMANCE CURVES**

GS 2900min <sup>-1</sup>	41
GS 1450min <sup>-1</sup>	76

**ELECTRICAL DATA**

GS 2900min <sup>-1</sup>	120
GS 1450min <sup>-1</sup>	124
Noise Data	127
Interchangeability Chart	128

## MAIN APPLICATIONS

INDUSTRY	BUILDING SERVICE	WATER SUPPLY
		
<ul style="list-style-type: none"> <li>• <b>Semiconductor Industry</b> Pure water</li> <li>• <b>Food industry</b> General water (Cooling water, Recycling water, Filtered water) Cleaning in place</li> <li>• <b>Pulp and Paper Industry</b> Water</li> <li>• <b>Automobile industry</b> Water (without slurry)</li> <li>• <b>Steel industry</b> Cooling Water Cooling Water with glycol (30%)</li> <li>• <b>Not ferrous metal industry</b> Cooling Water Cooling Water with glycol (30%)</li> <li>• <b>Garbage incineration</b> Cooling Water Deaerater Condensate water</li> <li>• <b>Pressurization for industrial use</b></li> </ul>	<ul style="list-style-type: none"> <li>• <b>Pressurization for buildings</b></li> <li>• <b>Fire-fighting system</b></li> <li>• <b>Heating and cooling systems</b></li> <li>• <b>Air conditioning system</b></li> </ul>	<ul style="list-style-type: none"> <li>• <b>Water supply duties for municipalities</b></li> <li>• <b>Irrigation</b></li> <li>• <b>Agriculture</b></li> <li>• <b>Swimming pool</b></li> </ul>

### PRODUCT FEATURES

#### GENERAL DESCRIPTION

- GS pump is an one-stage horizontal centrifugal pump
- To satisfy a wide range of market request GS models are available from DN 32 up to DN 200
- GS maximum working pressure is 16 bar for all sizes
- GS can work from -10°C up to +120°C
- GS is available with mechanical seal or gland packing seal
- GS is available in bare shaft and electropump version. In the second case all motors from 0,75 kW are guaranteed in IE3 efficiency class
- Compliant to European directives
- Certified to be sold in Russia, Kazakhstan and Belarus



#### MAIN FEATURES

- **Complete range:**  
A very wide product range, from DN 32 up to DN 200, which makes GS suitable for many operative conditions.
- **Energy saving:**  
Impeller design and double bronze wear ring optimize fluid movement inside the pump body, assuring one of higher MEI index in the market (MEI > 0,6 for all models )  
High motor efficiency IE3 starting from 0,75 kW, compliant to regulations EuP 2005/32/ Ec and ErP 2009/125/EC  
Possibility to mount VFD systems to obtain required performance
- **Interchangeability:**  
Complete interchangeability with competitor's models since all models are compliant to regulation EN733
- **Configuration:**  
Many different material configurations for a wide range of applications
- **Easier and faster maintenance:**  
Back pull out design, without removing pump body from pipeline  
Shielded bearings, which do not need to be lubricated
- **Gland packing version:**  
Not only mechanical seal version is available, but also gland packing version which guarantees an high wear resistance and allows to keep monitored seal of whole pumpset

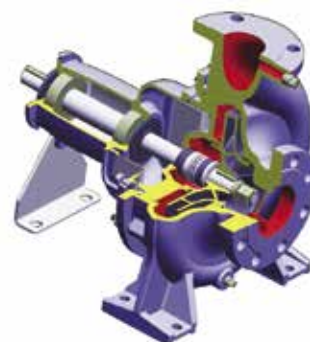

PUMP	
Capacities	To 1300 m <sup>3</sup> /h (50Hz)
Heads	To 150 m (50Hz)
Liquid temperatures	-10°C to 120°C <sup>(1)</sup>
Max. working pressures	Up to 16Bar (1.6 MPa)
Materials	Casing: cast iron
	Impeller: cast iron, ductile cast iron, bronze,
Seal	Mechanical Seal: SiC/C/EPDM
	Gland packing: Silicone carbide fiber
Standards	EN733 / ISO 2858 - EN 12756 - EN 294
Motor power	from 0,75 up to 355 kW
Rotation speed	1450 rpm or 2900 rpm
Rotation	Clockwise viewed from coupling end

<sup>(1)</sup> 0 - 80 °C in case of gland packing

## TYPE KEY

GS 4 32 - 125 - XXX / B 1 / E 0,75

**Motor Power [kW]**  
Blank = Pump without motor

**Type of coupling**  
E = Elastic coupling  
S = Spacer coupling  
Blank = Pump without motor

**Type of seal**  
1 = Mechanical seal  
3 = Gland packing

**Impeller material**  
B = Cast iron impeller  
M = Ductile cast iron impeller  
A = Bronze impeller

**Impeller diameter**

**Nominal impeller diameter in millimeters** <sup>(1)(2)</sup>

125.1 | 160.1 | 200.1 | 125 | 160 | 200 | 250(L) | 315(L) | 400 | 500

**Discharge nozzle, nominal size in millimeter**

32 | 40 | 50 | 65 | 80 | 100 | 125 | 150 | 200

**Number of poles**

2 = 2 poles  
4 = 4 poles  
Blank = Pump without motor

**Pump family**

<sup>(1)</sup> The letter "L" following the impeller classification code indicates different bearing designs. To give an example, GS80-315 and GS80-315L have different bearing designs and shaft size.

<sup>(2)</sup> The letter ".1" following the impeller classification code indicates different casing and impeller designs. To give an example, GS32-125 and GS32-125.1 have different casing and impeller designs.

e.g. PUMP WITHOUT MOTOR  
GS 32-125-170/B1

e.g. PUMP WITH MOTOR  
GS4 32-125-170/B1/E0,75



### PUMP NAMEPLATE

<b>EBARA PUMP</b>			
ITEM No. ①	CAP. ③		
SER. No. ②	HEAD ④		
MODEL ⑤	KW	min <sup>-1</sup>	
⑥	% [--, -] ⑦	MEI ≥ 0.4 ⑧	DATE ⑨
		EAC CE	

- ① Product code
- ② Serial number
- ③ Flow rate
- ④ Head
- ⑤ Pump model
- ⑥ Impeller diameter
- ⑦ Efficiency at duty point
- ⑧ MEI index
- ⑨ Production year

### ELECTRIC PUMP NAMEPLATE

<b>EBARA PUMP</b>			
ITEM No. ①	CAP. ③		
SER. No. ②	HEAD ④		
MODEL ⑤	⑥ KW	⑦ min <sup>-1</sup>	
⑧	% [--, -] ⑨	MEI ≥ 0.4 ⑩	DATE ⑪
		EAC CE	

- ① Product code
- ② Serial number
- ③ Flow rate
- ④ Head
- ⑤ Electric pump model
- ⑥ Motor power
- ⑦ Rotation speed
- ⑧ Manufacturing number
- ⑨ Efficiency at duty point
- ⑩ MEI index
- ⑪ Production year

For electric pump unit please refer to motor data plate for electrical data

## APPLICABLE MODEL

Model	Shaft No.	50Hz		Remarks
		2900min <sup>-1</sup> (2 poles)	1450min <sup>-1</sup> (4 poles)	
GS32-125.1	230	●	●	different hydraulic design each other
GS32-125	230	●	●	
GS32-160.1	230	●	●	different hydraulic design each other
GS32-160	230	●	●	
GS32-200.1	230	●	●	different hydraulic design each other
GS32-200	230	●	●	
GS32-250	230	●	●	
GS40-125	230	●	●	
GS40-160	230	●	●	
GS40-200	230	●	●	
GS40-250	230	●	●	
GS40-315	240	●	●	
GS50-125	230	●	●	
GS50-160	230	●	●	
GS50-200	230	●	●	
GS50-250	230	●	●	
GS50-315	240	●	●	
GS65-125	230	●	●	
GS65-160	230	●	●	
GS65-200	230	●	●	
GS65-250	240	●	●	
GS65-315	240	●	●	
GS80-160	230	●	●	
GS80-200	240	●	●	
GS80-250	240	●	●	
GS80-315	240	—	●	same hydraulic design and different shaft no. / bearings each other
GS80-315L	250	●	—	
GS80-400	250	—	●	
GS100-160	240	●	●	
GS100-200	240	●	●	
GS100-250	240	●	●	
GS100-315	240	—	●	same hydraulic design and different shaft no. / bearings each other
GS100-315L	250	●	—	
GS100-400	250	—	●	
GS125-200	240	●	●	different shaft no. / bearings each other
GS125-250	240	—	●	
GS125-250L	250	●	—	
GS125-315	250	●	●	
GS125-400	250	—	●	
GS125-500	260	—	●	
GS150-200	240	●	●	
GS150-250	250	●	●	
GS150-315	250	—	●	
GS150-400	250	—	●	
GS150-500	270	—	●	
GS200-400	270	—	●	
GS200-500	280	—	●	

### SECTIONAL VIEW MECHANICAL SEAL TYPE

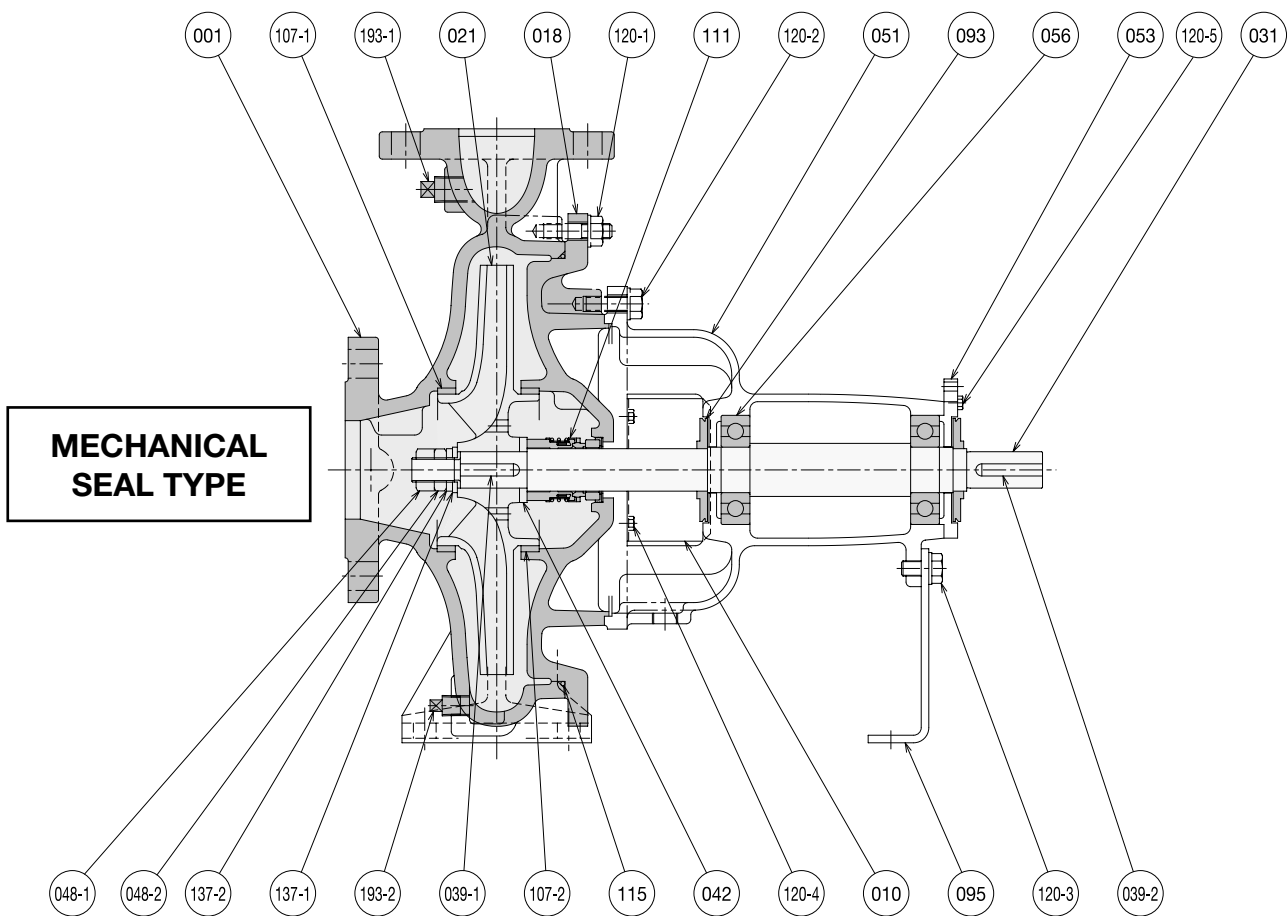

No.	Part name	Qty	No.	Part name	Qty
001	Casing	1	095	Stay	1
010	Protector	2	107-1	Case Wear Ring	1
018	Casing cover	1	107-2	Case Wear Ring	1
021	Impeller	1	111	Mechanical seal	1
031	Shaft	1	115	O-Ring	1
039-1	Key	1	120-1	Bolt	-
039-2	Key	1	120-2	Bolt	6
042	Spacer	1	120-3	Bolt	1
048-1	Impeller nut (A)	1	120-4	Bolt	4
048-2	Impeller nut (B)	1	120-5	Bolt	4
051	Bearing housing	1	137-1	Plain washer	1
053	Bearing cover	1	137-2	Spring lock washer	1
056	Ball bearing	2	193-1	Plug	1
093	Deflector	2	193-2	Plug	1

SECTIONAL VIEW DATA  
GLAND PACKING TYPE

CONSTRUCTION

GLAND PACKING  
TYPE

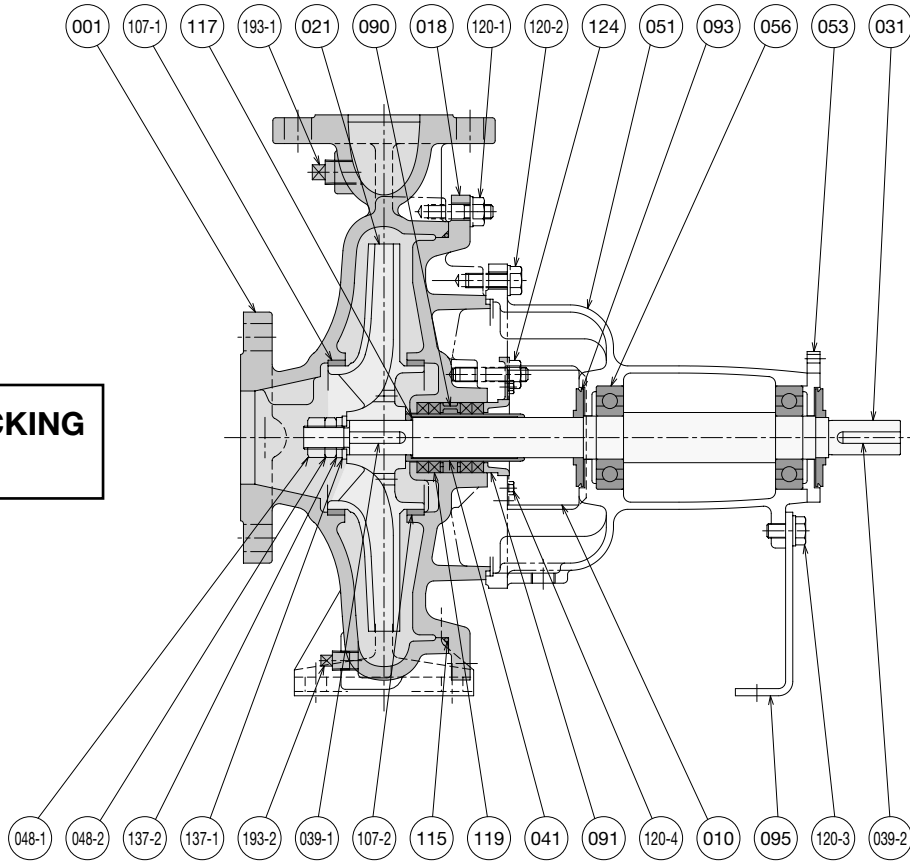

No.	Part name	Qty	No.	Part name	Qty
001	Casing	1	095	Stay	1
010	Protector	2	107-1	Case wear ring	1
018	Casing cover	1	107-2	Case wear ring	1
021	Impeller	1	115	O-ring	1
031	Shaft	1	117	Gasket	1
039-1	Key	1	119	Gland packing	4
039-2	Key	1	120-1	Bolt	-
041	Shaft sleeve	1	120-2	Bolt	6
048-1	Impeller nut (A)	1	120-3	Bolt	1
048-2	Impeller nut (B)	1	120-4	Bolt	4
051	Bearing housing	1	120-5	Bolt	4
053	Bearing cover	1	124	Gland bolt	2
056	Ball bearing	2	137-1	Plain washer	1
090	Lantern ring	1	137-2	Spring lock washer	1
091	Gland	1	193-1	Plug	1
093	Deflector	2	193-2	Plug	1

### MATERIALS OF CONSTRUCTION MECHANICAL SEAL TYPE

No.	Part name	Materials	ISO or EN equivalent
001	Casing	Cast iron	EN-GJL-250(EN-JL1040)
010	Protector	Carbon steel	DC01(1.0330)
018	Casing cover	Cast iron	EN-GJL-250(EN-JL1040)
021	Impeller	Cast iron	EN-GJL-200(EN-JL1030)
		Ductile cast iron <sup>(1)</sup>	EN-GJS-400-15(5.3106)
		Bronze	CuSn5Zn5Pb5(CC491K)
031	Shaft	Cr. steel	X17CrNi16-2(1.4057)
039-1	Key	12% Cr. steel	X30Cr13(1.4028)
039-2	Key	Carbon steel	C50(1.0540)
042	Spacer	304 Stainless steel	X5CrNi18-10(1.4301)
048-1	Impeller nut (A)	304 Stainless steel	X5CrNi18-10(1.4301)
048-2	Impeller nut (B)	304 Stainless steel	X5CrNi18-10(1.4301)
051	Bearing housing	Cast iron	EN-GJL-150(EN-JL1020)
053	Bearing cover	Cast iron	EN-GJL-150(EN-JL1020)
056	Ball bearing	Steel	---
093	Deflector	EPDM	---
095	Stay	Carbon steel	---
107-1	Case Wear Ring	Bronze	CuSn5Zn5Pb5(CC491K)
107-2	Case Wear Ring	Bronze	CuSn5Zn5Pb5(CC491K)
111	Mechanical Seal	Sic/carbon/EPDM	---
115	O-Ring	EPDM	---
120-1/5	Bolts	Carbon steel	---
137-1	Plain Washer	304 Stainless steel	X5CrNi18-10(1.4301)
137-2	Spring Lock Washer	304 Stainless steel	X5CrNi18-10(1.4301)
193-1	Plug	Carbon steel	---
193-2	Plug	Carbon steel	---

<sup>(1)</sup> For pump models GS100-400, 125-400, 125-500, 150-400, 150-500, 200-400 and 200-500 impellers are made of ductile cast iron

### MATERIALS OF CONSTRUCTION GLAND PACKING TYPE <sup>(1)</sup>

No.	Part name	Materials	ISO or EN equivalent
018	CASING COVER (cylindrical)	Cast iron	EN-GJL-250(EN-JL1040)
041	SHAFT SLEEVE	304 Stainless steel	X5CrNi18-10(1.4301)
090	LANTERN RING	Bronze	CuSn5Zn5Pb5
091	GLAND	Bronze	CuSn5Zn5Pb5
117	GASKET	Joint sheet gasket	---
119	GLAND PACKING	Silicone carbide fiber packing	---
124	GLAND BOLT	Brass	---

<sup>(1)</sup> Gland packing type includes all these components instead of components n. 018, 042 and 111 which are included in mechanical seal pump version.

## AVAILABILITY OF MATERIALS

Model	Materials				Shaft		Flange - DIN PN16 Cast iron
	Pump casing	Impeller			Mechanical seal	Gland packing <sup>(1)</sup>	
	Cast iron	Cast iron	Ductile cast iron	Bronze			
32-125.1	●	-	-	●	●	●	●
32-160.1	●	-	-	●	●	●	●
32-200.1	●	-	-	●	●	●	●
32-125	●	-	-	●	●	●	●
32-160	●	-	-	●	●	●	●
32-200	●	-	-	●	●	●	●
32-250	●	●	-	●	●	●	●
40-125	●	-	-	●	●	●	●
40-160	●	-	-	●	●	●	●
40-200	●	●	-	●	●	●	●
40-250	●	●	-	●	●	●	●
40-315	●	●	-	●	●	●	●
50-125	●	-	-	●	●	●	●
50-160	●	●	-	●	●	●	●
50-200	●	●	-	●	●	●	●
50-250	●	●	-	●	●	●	●
50-315	●	●	-	●	●	●	●
65-125	●	-	-	●	●	●	●
65-160	●	●	-	●	●	●	●
65-200	●	●	-	●	●	●	●
65-250	●	●	-	●	●	●	●
65-315	●	●	-	●	●	●	●
80-160	●	●	-	●	●	●	●
80-200	●	●	-	●	●	●	●
80-250	●	●	-	●	●	●	●
80-315	●	●	-	●	●	●	●
80-315L	●	●	-	●	●	●	●
80-400	●	●	-	●	●	●	●
100-160	●	●	-	●	●	●	●
100-200	●	●	-	●	●	●	●
100-250	●	●	-	●	●	●	●
100-250L	●	●	-	●	●	●	●
100-315	●	●	-	●	●	●	●
100-315L	●	●	-	●	●	●	●
100-400	●	-	●	●	●	●	●
125-200	●	●	-	●	●	●	●
125-250	●	●	-	●	●	●	●
125-250L	●	●	-	●	●	●	●
125-315	●	●	-	●	●	●	●
125-400	●	-	●	●	●	●	●
125-500	●	-	●	●	●	●	●
150-200	●	●	-	●	●	●	●
150-250	●	●	-	●	●	●	●
150-315	●	●	-	●	●	●	●
150-400	●	-	●	●	●	●	●
150-400L	●	-	●	●	●	●	●
150-500	●	-	●	●	●	●	●
200-400	●	-	●	●	●	●	●
200-500	●	-	●	●	●	●	●

● = Available

<sup>(1)</sup> = Available only with bronze impeller

### IMPELLER DIAMETER

Model	Shaft No.	Impeller diameter dimension range [mm]			
		2 Poles		4 Poles	
		Max	Min	Max	Min
GS32-125.1	230	140	100	140	100
GS32-125	230	142	106	142	106
GS32-160.1	230	177	126	177	126
GS32-160	230	177	139	177	139
GS32-200.1	230	207	172	207	172
GS32-200	230	219	175	219	170
GS32-250	230	262	198	262	198
GS40-125	230	142	105	142	105
GS40-160	230	177	134	177	134
GS40-200	230	219	172	219	172
GS40-250	230	260	211	260	211
GS40-315	240	326	256	334	263
GS50-125	230	144	111	144	111
GS50-160	230	177	131	177	131
GS50-200	230	219	171	219	171
GS50-250	230	270	210	270	210
GS50-315	240	324	277	344	277
GS65-125	230	147	120	147	120
GS65-160	230	177	135	177	135
GS65-200	230	219	162	219	162
GS65-250	240	273	215	273	215
GS65-315	240	320	258	320	261
GS80-160	230	177	137	177	137
GS80-200	240	222	165	222	165
GS80-250	240	270	220	270	220
GS80-315	240	--	-	334	262
GS80-315L	250	334	265	-	-
GS80-400	250	-	-	438	335
GS100-160	240	183	149	183	149
GS100-200	240	220	171	220	171
GS100-250	240	265	210	270	210
GS100-315	240	-	-	312	242
GS100-315L	250	312	242	-	-
GS100-400	250	-	-	412	320
GS125-200	240	224	174	224	174
GS125-250	240	-	-	274	213
GS125-250L	250	274	213	-	-
GS125-315	250	309	259	334	259
GS125-400	250	-	-	424	329
GS125-500	260	-	-	511	396
GS150-200	240	211	164	211	164
GS150-250	250	250	213	274	213
GS150-315	250	-	-	352	273
GS150-400	250	-	-	411	319
GS150-500	270	-	-	511	396
GS200-400	270	-	-	420	326
GS200-500	280	-	-	530	411

-- = Not applicable model

## NOMINAL DIMENSIONS OF PARTS

Model	Shaft No.	Case Wear Ring Front side [mm]	Case Wear Ring Back side [mm]	Casing O-Ring [mm]	Ball Bearing type	For Gland Packing [mm]	
						Gland Packing	Sleeve Gasket
GS32-125.1	230	76	76	3.53X183.74	6306ZZ	33X49X8	24X28X1
GS32-125	230	76	76	3.53X183.74	6306ZZ	33X49X8	24X28X1
GS32-160.1	230	76	76	3.53X183.74	6306ZZ	33X49X8	24X28X1
GS32-160	230	76	76	3.53X183.74	6306ZZ	33X49X8	24X28X1
GS32-200.1	230	76	76	3.53X234.54	6306ZZ	33X49X8	24X28X1
GS32-200	230	76	76	3.53X234.54	6306ZZ	33X49X8	24X28X1
GS32-250	230	76	76	3.53X278.99	6306ZZ	33X49X8	24X28X1
GS40-125	230	88	88	3.53X183.74	6306ZZ	33X49X8	24X28X1
GS40-160	230	88	88	3.53X183.74	6306ZZ	33X49X8	24X28X1
GS40-200	230	88	88	3.53X234.54	6306ZZ	33X49X8	24X28X1
GS40-250	230	88	88	3.53X278.99	6306ZZ	33X49X8	24X28X1
GS40-315	240	100	100	3.53X355.19	6308ZZ	43X63X10	32X38X1
GS50-125	230	100	100	3.53X183.74	6306ZZ	33X49X8	24X28X1
GS50-160	230	100	100	3.53X183.74	6306ZZ	33X49X8	24X28X1
GS50-200	230	100	100	3.53X234.54	6306ZZ	33X49X8	24X28X1
GS50-250	230	100	100	3.53X278.99	6306ZZ	33X49X8	24X28X1
GS50-315	240	116	116	3.53X355.19	6308ZZ	43X63X10	32X38X1
GS65-125	230	116	116	3.53X183.74	6306ZZ	33X49X8	24X28X1
GS65-160	230	116	116	3.53X183.74	6306ZZ	33X49X8	24X28X1
GS65-200	230	116	116	3.53X234.54	6306ZZ	33X49X8	24X28X1
GS65-250	240	116	116	3.53X278.99	6308ZZ	43X63X10	32X38X1
GS65-315	240	132	132	3.53X355.19	6308ZZ	43X63X10	32X38X1
GS80-160	230	132	132	3.53X183.74	6306ZZ	33X49X8	24X28X1
GS80-200	240	132	132	3.53X234.54	6308ZZ	43X63X10	32X38X1
GS80-250	240	148	148	3.53X278.99	6308ZZ	43X63X10	32X38X1
GS80-315	240	148	148	3.53X355.19	6308ZZ	43X63X10	32X38X1
GS80-315L	250	148	148	3.53X355.19	6310ZZ	53X73X10	42X48X1
GS80-400	250	148	148	5.33X456.06	6310ZZ	53X73X10	42X48X1
GS100-160	240	148	153	3.53X183.74	6308ZZ	43X63X10	32X38X1
GS100-200	240	158	158	3.53X234.54	6308ZZ	43X63X10	32X38X1
GS100-250	240	158	158	3.53X278.99	6308ZZ	43X63X10	32X38X1
GS100-250L	250	158	158	3.53X278.99	6310ZZ	53X73X10	42X48X1
GS100-315	240	158	162	3.53X355.19	6308ZZ	43X63X10	32X38X1
GS100-315L	250	158	162	3.53X355.19	6310ZZ	53X73X10	42X48X1
GS100-400	250	168	168	5.33X456.06	6310ZZ	53X73X10	42X48X1
GS125-200	240	168	158	3.53X234.54	6308ZZ	43X63X10	32X38X1
GS125-250	240	178	168	3.53X278.99	6308ZZ	43X63X10	32X38X1
GS125-250L	250	178	178	3.53X278.99	6310ZZ	53X73X10	42X48X1
GS125-315	250	188	178	3.53X355.19	6310ZZ	53X73X10	42X48X1
GS125-400	250	188	188	5.33X456.06	6310ZZ	53X73X10	42X48X1
GS125-500	260	200	200	5.33X532.26	6312ZZ	60X85X12.5	48X55X1
GS150-200	240	178	162	3.53X234.54	6308ZZ	43X63X10	32X38X1
GS150-250	250	212	212	3.53X278.99	6310ZZ	53X73X10	42X48X1
GS150-315	250	212	212	3.53X355.19	6310ZZ	53X73X10	42X48X1
GS150-400	250	236	236	5.33X456.06	6310ZZ	53X73X10	42X48X1
GS150-400L	260	236	236	5.33X456.06	6312ZZ	60X85X12.5	48X55X1
GS150-500	270	250	250	5.33X532.26	6314ZZ	70X95X12.5	60X65X1
GS200-400	270	278	278	5.33X456.06	6314ZZ	70X95X12.5	60X65X1
GS200-500	280	278	278	5.33X532.26	6316ZZ	80X109X14.5	70X75X1

Note: Materials of every components is specified in the section of "Materials of Construction".



### SELECTION OF SHAFT SEAL

#### MECHANICAL SEAL

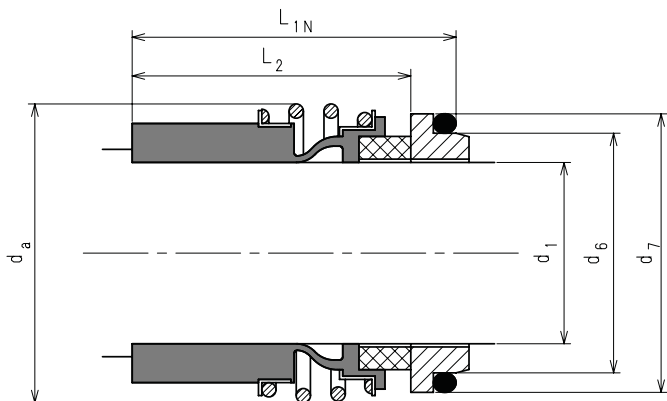

Mechanical seal	Dimensions [mm]					
	d1	da	d6	d7	L <sub>1N</sub>	L <sub>2</sub>
A	28	49	37	43	50	42,5
B	38	59	49	56	55	46
C	48	70,5	59	66	60	51
D	55	81	67	75	70	59
E	65	93,5	77	85	80	69
F	75	107	88	97	80	68,7

Note: for correspondance between seal and pump model, please see page 128

Liquid temperature	Liquid	Rotating part	Fixed part	Elastomers	Spring
-10 to 120 °C	Clean water, hot water, water with glicole (30%)	Silicon carbide (Q1)	Carbon graphite resin impregnated (B)	Ethylene propylene rubber - EPDM (E)	AISI 316 (G)

#### GLAND PACKING

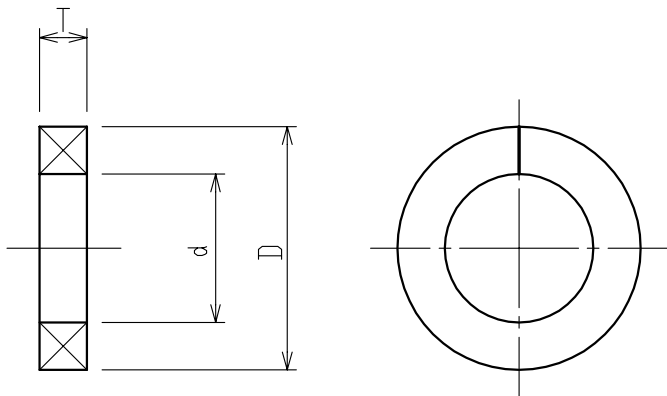

Gland packing	Dimensions [mm]		
	d	D	T
A	33	49	8,1
B	43	63	10,2
C	53	73	10,2
D	60	85	12,5
E	70	95	12,5
F	80	109	14,5

Note: for correspondance between seal and pump model, please see page 128

Liquid temperature	Liquid PH	Liquid	Material
0 to 80°C	from 2 up to 12	Clean water, hot water, slightly acid water, slightly alkaline water, oil	Silicon carbide fiber packing

DIMENSIONAL DRAWINGS  
GS 2900min-1

FIG. 1 - STEEL BASE PLATE - UP TO 90 kW

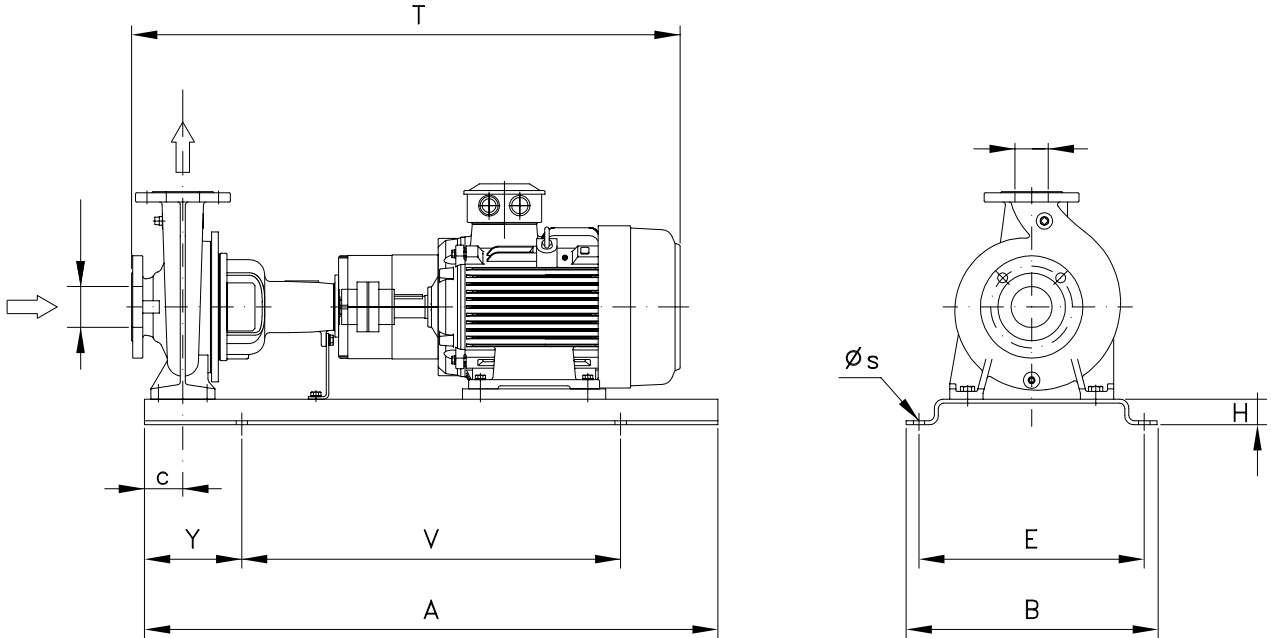
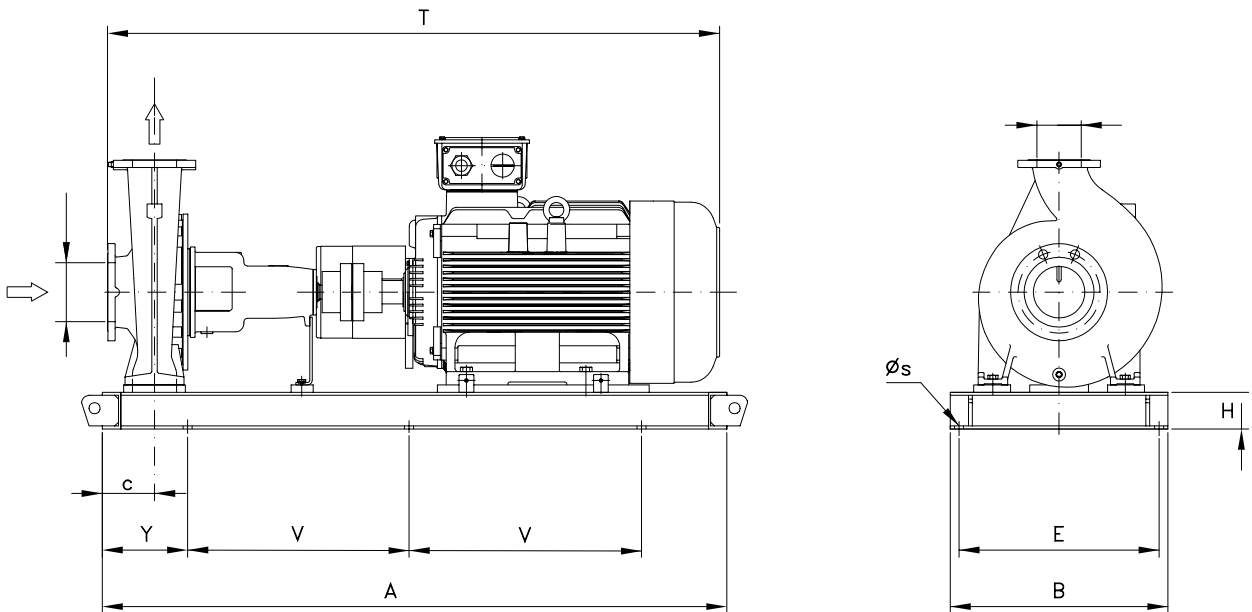

FIG. 2 - FABRICATED BASE PLATE - FROM 110 kW AND ABOVE







## DIMENSIONAL TABLE

### GS 2900min<sup>-1</sup>

Model	Fig.	Motor		Common* c	Dimensions [mm]								Weight [kg]	Dimensions [mm]								Weight [kg]
		kW	Frame		Standard coupling									Spacer coupling								
					A	B	Y	V	E	H	s	T		A	B	Y	V	E	H	s	T	
80-160	1	7,5	132S	125	1120	490	190	740	440	50	22	940	154	1120	490	190	740	440	50	22	1077	155
80-160	1	11	160M	125	1120	610	190	740	550	50	22	1086	198	1400	610	230	940	550	75	26	1223	237
80-160	1	15	160M	125	1120	610	190	740	550	50	22	1086	205	1400	610	230	940	550	75	26	1223	244
80-160	1	18,5	160L	125	1120	610	190	740	550	50	22	1130	218	1400	610	230	940	550	75	26	1267	257
80-160	1	22	180M	125	1120	610	190	740	550	50	22	1152	259	1400	610	230	940	550	75	26	1289	299
80-160	1	30	200L	125	1120	610	190	740	550	50	22	1255	321	1400	610	230	940	550	75	26	1392	362
80-200	1	15	160M	125	1400	610	230	940	550	75	26	1196	264	1400	610	230	940	550	75	26	1333	265
80-200	1	18,5	160L	125	1400	610	230	940	550	75	26	1240	277	1400	610	230	940	550	75	26	1377	278
80-200	1	22	180M	125	1400	610	230	940	550	75	26	1262	318	1400	610	230	940	550	75	26	1399	320
80-200	1	30	200L	125	1400	610	230	940	550	75	26	1365	380	1400	610	230	940	550	75	26	1502	383
80-200	1	37	200L	125	1400	610	230	940	550	75	26	1365	405	1400	610	230	940	550	75	26	1502	408
80-200	1	45	225M	125	1400	730	230	940	670	75	26	1484	549	1600	660	270	1060	600	75	26	1621	557
80-200	1	55	250M	125	1600	660	270	1060	600	75	26	1563	605	1600	660	270	1060	600	75	26	1700	610
80-250	1	22	180M	125	1400	610	230	940	550	75	26	1262	328	1400	610	230	940	550	75	26	1399	330
80-250	1	30	200L	125	1400	610	230	940	550	75	26	1365	390	1400	610	230	940	550	75	26	1502	393
80-250	1	37	200L	125	1400	610	230	940	550	75	26	1365	415	1400	610	230	940	550	75	26	1502	418
80-250	1	45	225M	125	1400	730	230	940	670	75	26	1484	559	1600	660	270	1060	600	75	26	1621	567
80-250	1	55	250M	125	1600	660	270	1060	600	75	26	1563	615	1600	660	270	1060	600	75	26	1700	620
80-250	1	75	280S	125	1800	730	300	1200	670	100	26	1669	849	1800	730	300	1200	670	100	26	1806	855
80-250	1	90	280M	125	1800	730	300	1200	670	100	26	1669	929	1800	730	300	1200	670	100	26	1806	935
80-315L	1	75	280S	125	1800	730	300	1200	670	100	26	1729	884	1800	730	300	1200	670	100	26	1866	890
80-315L	1	90	280M	125	1800	730	300	1200	670	100	26	1729	964	1800	730	300	1200	670	100	26	1866	970
80-315L	2	110	315S	245	2120	820	210	850	770	160	20	1932	1212	2300	820	230	920	760	160	20	2069	1225
80-315L	2	132	315M	245	2120	820	210	850	770	160	20	1932	1262	2300	820	230	920	760	160	20	2069	1275
80-315L	2	160	315M	245	2260	820	230	900	770	160	20	1932	1353	2440	820	250	970	760	160	20	2069	1366
100-160	1	18,5	160L	125	1400	610	230	940	550	75	26	1240	301	1400	610	230	940	550	75	26	1377	302
100-160	1	22	180M	125	1400	610	230	940	550	75	26	1262	342	1400	610	230	940	550	75	26	1399	344
100-160	1	30	200L	125	1400	610	230	940	550	75	26	1365	404	1400	610	230	940	550	75	26	1502	407
100-160	1	37	200L	125	1400	610	230	940	550	75	26	1365	429	1400	610	230	940	550	75	26	1502	432
100-200	1	18,5	160L	125	1400	610	230	940	550	75	26	1240	313	1400	610	230	940	550	75	26	1377	314
100-200	1	22	180M	125	1400	610	230	940	550	75	26	1262	354	1400	610	230	940	550	75	26	1399	356
100-200	1	30	200L	125	1400	610	230	940	550	75	26	1365	416	1400	610	230	940	550	75	26	1502	419
100-200	1	37	200L	125	1400	610	230	940	550	75	26	1365	441	1400	610	230	940	550	75	26	1502	444
100-200	1	45	225M	125	1400	730	230	940	670	75	26	1484	585	1600	660	270	1060	600	75	26	1621	593
100-200	1	55	250M	125	1600	660	270	1060	600	75	26	1563	641	1600	660	270	1060	600	75	26	1700	646
100-200	1	75	280S	125	1800	730	300	1200	670	100	26	1669	875	1800	730	300	1200	670	100	26	1806	881
100-250	1	30	200L	140	1400	730	230	940	670	75	26	1380	435	1400	730	230	940	670	75	26	1517	438
100-250	1	37	200L	140	1400	730	230	940	670	75	26	1380	460	1400	730	230	940	670	75	26	1517	463
100-250	1	45	225M	140	1600	660	270	1060	600	75	26	1499	595	1600	660	270	1060	600	75	26	1636	598
100-250	1	55	250M	140	1600	660	270	1060	600	75	26	1578	646	1600	660	270	1060	600	75	26	1715	651
100-250	1	75	280S	140	1800	730	300	1200	670	100	26	1684	880	1800	730	300	1200	670	100	26	1821	886
100-250	1	90	280M	140	1800	730	300	1200	670	100	26	1684	960	1800	730	300	1200	670	100	26	1821	966
100-250	2	110	315S	240	1980	820	190	800	770	160	20	1887	1202	2150	820	210	865	770	160	20	2024	1215
100-315L	1	75	280S	140	1800	730	300	1200	670	100	26	1744	906	1800	730	300	1200	670	100	26	1881	912
100-315L	1	90	280M	140	1800	730	300	1200	670	100	26	1744	986	1800	730	300	1200	670	100	26	1881	992
100-315L	2	110	315S	245	2120	820	210	850	770	160	20	1947	1234	2300	820	230	920	760	160	20	2084	1247
100-315L	2	132	315M	245	2120	820	210	850	770	160	20	1947	1284	2300	820	230	920	760	160	20	2084	1297
100-315L	2	160	315M	245	2260	820	230	900	770	160	20	1947	1375	2440	820	250	970	760	160	20	2084	1388
100-315L	2	200	315M	245	2260	820	230	900	770	160	20	1947	1495	2440	820	250	970	760	160	20	2084	1509

\* For bare shaft pump dimensions please see page 28 and following

### DIMENSIONAL TABLE

#### GS 2900min<sup>-1</sup>

Model	Fig.	Motor		Common <sup>*</sup>	Dimensions [mm]								Weight [kg]	Dimensions [mm]								Weight [kg]
		kW	Frame		Standard coupling				Spacer coupling													
				c	A	B	Y	V	E	H	s	T		A	B	Y	V	E	H	s	T	
125-200	1	37	200L	140	1400	730	230	940	670	75	26	1380	472	1400	730	230	940	670	75	26	1517	475
125-200	1	45	225M	140	1600	660	270	1060	600	75	26	1499	607	1600	660	270	1060	600	75	26	1636	610
125-200	1	55	250M	140	1600	660	270	1060	600	75	26	1578	658	1600	660	270	1060	600	75	26	1715	663
125-200	1	75	280S	140	1800	730	300	1200	670	100	26	1684	892	1800	730	300	1200	670	100	26	1821	898
125-200	1	90	280M	140	1800	730	300	1200	670	100	26	1684	972	1800	730	300	1200	670	100	26	1821	978
125-200	2	110	315S	240	1980	820	190	800	770	160	20	1887	1214	2150	820	210	865	770	160	20	2024	1227
125-250L	1	75	280S	140	1800	730	300	1200	670	100	26	1744	920	1800	730	300	1200	670	100	26	1881	926
125-250L	1	90	280M	140	1800	730	300	1200	670	100	26	1744	1000	1800	730	300	1200	670	100	26	1881	1006
125-250L	2	110	315S	245	2120	820	210	850	770	160	20	1947	1248	2300	820	230	920	760	160	20	2084	1261
125-250L	2	132	315M	245	2120	820	210	850	770	160	20	1947	1298	2300	820	230	920	760	160	20	2084	1311
125-250L	2	160	315M	245	2260	820	230	900	770	160	20	1947	1389	2440	820	250	970	760	160	20	2084	1402
125-250L	2	200	315M	245	2260	820	230	900	770	160	20	1947	1509	2440	820	250	970	760	160	20	2084	1523
125-315	1	90	280M	140	1800	850	300	1200	780	100	26	1744	1045	1800	850	300	1200	780	100	26	1881	1051
125-315	2	110	315S	245	2120	820	210	850	770	160	20	1947	1276	2300	820	230	920	760	160	20	2084	1289
125-315	2	132	315M	245	2120	820	210	850	770	160	20	1947	1326	2300	820	230	920	760	160	20	2084	1339
125-315	2	160	315M	245	2260	820	230	900	770	160	20	1947	1417	2440	820	250	970	760	160	20	2084	1430
125-315	2	200	315M	245	2260	820	230	900	770	160	20	1947	1537	2440	820	250	970	760	160	20	2084	1551
150-200	1	37	200L	160	1400	730	230	940	670	75	26	1400	506	1800	730	300	1200	670	100	26	1537	546
150-200	1	45	225M	160	1600	660	270	1060	600	75	26	1519	641	1800	730	300	1200	670	100	26	1656	676
150-200	1	55	250M	160	1600	660	270	1060	600	75	26	1598	692	1800	730	300	1200	670	100	26	1735	729
150-200	1	75	280S	160	1800	730	300	1200	670	100	26	1704	926	1800	730	300	1200	670	100	26	1841	932
150-200	1	90	280M	160	1800	730	300	1200	670	100	26	1704	1006	1800	730	300	1200	670	100	26	1841	1018
150-250	1	37	315S	245	2120	820	210	850	770	160	20	1967	1271	2300	820	230	920	760	160	20	2104	1284
150-250	1	45	315M	245	2120	820	210	850	770	160	20	1967	1321	2300	820	230	920	760	160	20	2104	1334
150-250	1	55	315M	245	2260	820	230	900	770	160	20	1967	1412	2440	820	250	970	760	160	20	2104	1425
150-250	1	75	315M	245	2260	820	230	900	770	160	20	1967	1532	2440	820	250	970	760	160	20	2104	1546

\* For bare shaft pump dimensions please see page 28 and following

### DIMENSIONAL DRAWINGS GS 1450min<sup>-1</sup>

FIG. 1 - STEEL BASE PLATE - UP TO 90 kW

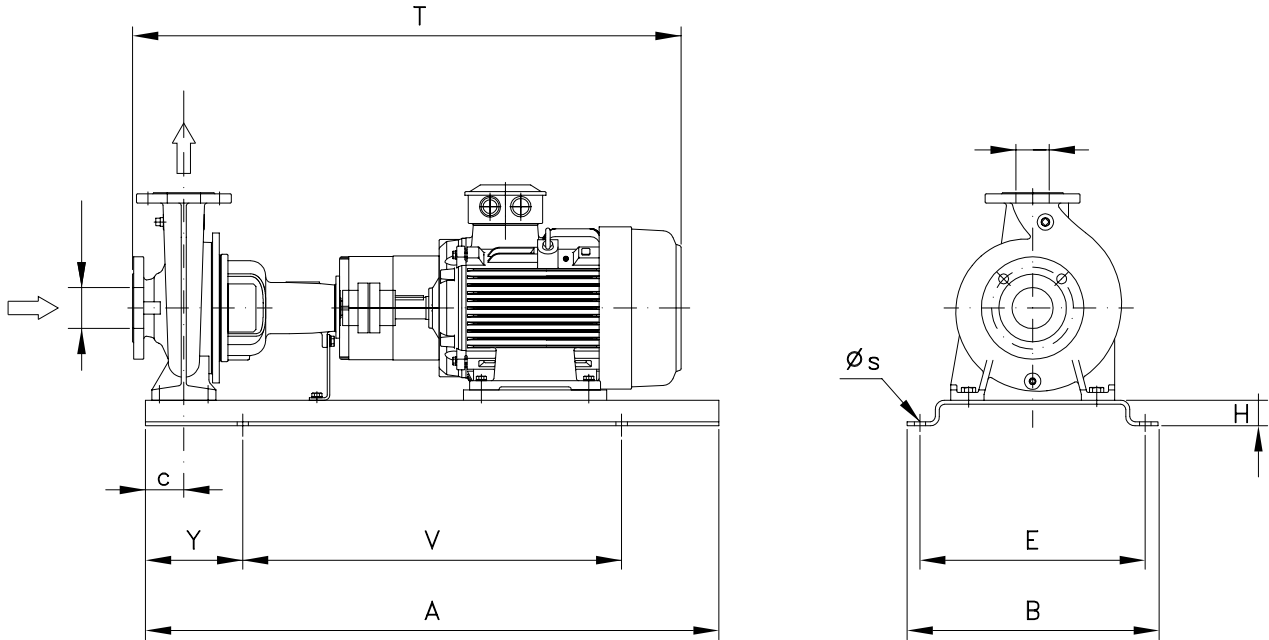
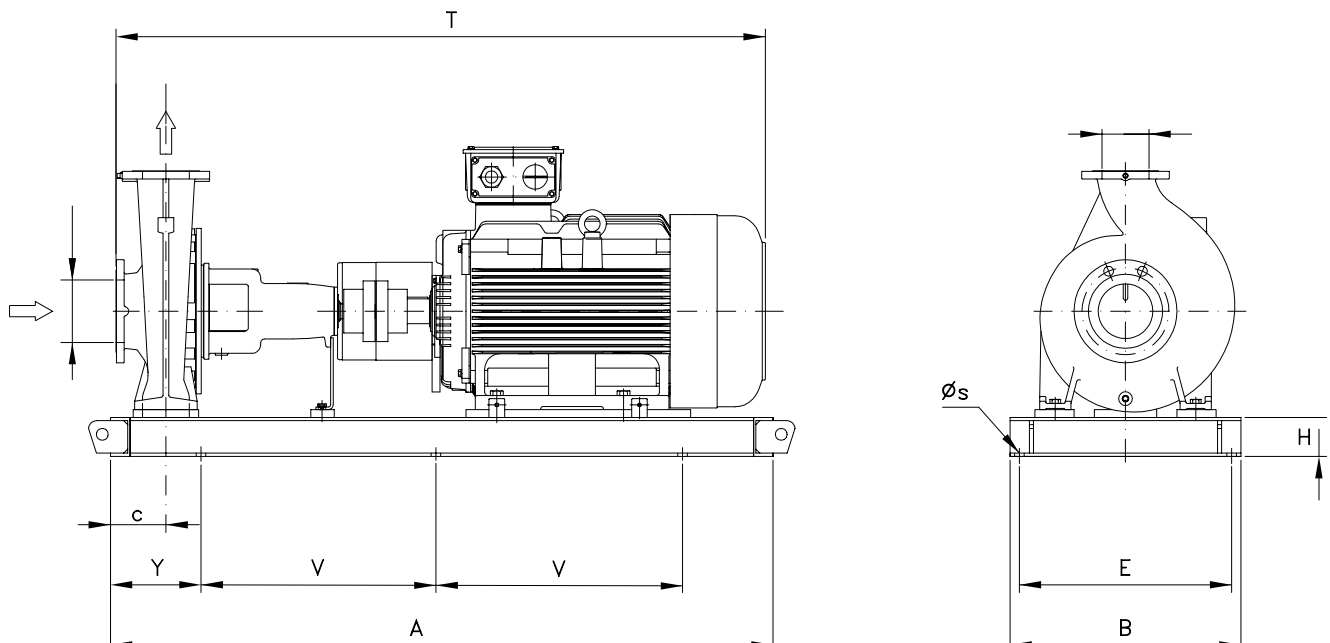

FIG. 2 - FABRICATED BASE PLATE - FROM 110 kW AND ABOVE



### DIMENSIONAL TABLE GS 1450min<sup>-1</sup>

Model	Fig.	Motor		Common*	Dimensions [mm]								Weight [kg]	Dimensions [mm]								Weight [kg]
		kW	Frame		Standard coupling				Spacer coupling													
				c	A	B	Y	V	E	H	s	T		A	B	Y	V	E	H	s	T	
32-125.1	1	0,37	71	80	900	390	150	600	350	50	18	691	65	900	390	150	600	350	50	18	788	67
32-125.1	1	0,55	80	80	900	390	150	600	350	50	18	719	68	900	390	150	600	350	50	18	816	70
32-125	1	0,37	71	80	900	390	150	600	350	50	18	691	65	900	390	150	600	350	50	18	788	67
32-125	1	0,55	80	80	900	390	150	600	350	50	18	719	68	900	390	150	600	350	50	18	816	70
32-125	1	0,75	80	80	900	390	150	600	350	50	18	719	70	900	390	150	600	350	50	18	816	72
32-160.1	1	0,37	71	80	900	390	150	600	350	50	18	691	66	900	390	150	600	350	50	18	788	68
32-160.1	1	0,55	80	80	900	390	150	600	350	50	18	719	69	900	390	150	600	350	50	18	816	71
32-160.1	1	0,75	80	80	900	390	150	600	350	50	18	719	71	900	390	150	600	350	50	18	816	73
32-160	1	0,37	71	80	900	390	150	600	350	50	18	691	66	900	390	150	600	350	50	18	788	68
32-160	1	0,55	80	80	900	390	150	600	350	50	18	719	69	900	390	150	600	350	50	18	816	71
32-160	1	0,75	80	80	900	390	150	600	350	50	18	719	71	900	390	150	600	350	50	18	816	73
32-200.1	1	0,55	80	80	900	390	150	600	350	50	18	719	79	900	390	150	600	350	50	18	816	81
32-200.1	1	0,75	80	80	900	390	150	600	350	50	18	719	81	900	390	150	600	350	50	18	816	83
32-200.1	1	1,1	90S	80	900	390	150	600	350	50	18	747	86	900	390	150	600	350	50	18	844	88
32-200	1	0,55	80	80	900	390	150	600	350	50	18	719	79	900	390	150	600	350	50	18	816	81
32-200	1	0,75	80	80	900	390	150	600	350	50	18	719	81	900	390	150	600	350	50	18	816	83
32-200	1	1,1	90S	80	900	390	150	600	350	50	18	747	86	900	390	150	600	350	50	18	844	88
32-200	1	1,5	90L	80	900	390	150	600	350	50	18	772	89	900	390	150	600	350	50	18	869	91
32-250	1	0,75	80	100	900	490	150	600	440	50	18	739	93	900	490	150	600	440	50	18	836	95
32-250	1	1,1	90S	100	900	490	150	600	440	50	18	767	98	900	490	150	600	440	50	18	864	100
32-250	1	1,5	90L	100	900	490	150	600	440	50	18	792	101	900	490	150	600	440	50	18	889	103
32-250	1	2,2	100L	100	900	490	150	600	440	50	18	839	111	900	490	150	600	440	50	18	936	112
32-250	1	3	100L	100	900	490	150	600	440	50	18	839	117	900	490	150	600	440	50	18	936	118
40-125	1	0,37	71	80	900	390	150	600	350	50	18	691	67	900	390	150	600	350	50	18	788	69
40-125	1	0,55	80	80	900	390	150	600	350	50	18	719	70	900	390	150	600	350	50	18	816	72
40-125	1	0,75	80	80	900	390	150	600	350	50	18	719	72	900	390	150	600	350	50	18	816	74
40-160	1	0,37	71	80	900	390	150	600	350	50	18	691	68	900	390	150	600	350	50	18	788	70
40-160	1	0,55	80	80	900	390	150	600	350	50	18	719	71	900	390	150	600	350	50	18	816	73
40-160	1	0,75	80	80	900	390	150	600	350	50	18	719	73	900	390	150	600	350	50	18	816	75
40-160	1	1,1	90S	80	900	390	150	600	350	50	18	747	78	900	390	150	600	350	50	18	844	80
40-160	1	1,5	90L	80	900	390	150	600	350	50	18	772	81	900	390	150	600	350	50	18	869	83
40-200	1	0,55	80	100	900	490	150	600	440	50	18	739	86	1000	450	170	660	400	50	22	836	90
40-200	1	0,75	80	100	900	490	150	600	440	50	18	739	88	1000	450	170	660	400	50	22	836	92
40-200	1	1,1	90S	100	900	490	150	600	440	50	18	767	93	1000	450	170	660	400	50	22	864	97
40-200	1	1,5	90L	100	900	490	150	600	440	50	18	792	96	1000	450	170	660	400	50	22	889	100
40-200	1	2,2	100L	100	900	490	150	600	440	50	18	839	105	1000	450	170	660	400	50	22	936	109
40-250	1	1,1	90S	100	900	490	150	600	440	50	18	767	100	900	490	150	600	440	50	18	864	102
40-250	1	1,5	90L	100	900	490	150	600	440	50	18	792	103	900	490	150	600	440	50	18	889	105
40-250	1	2,2	100L	100	900	490	150	600	440	50	18	839	113	900	490	150	600	440	50	18	936	114
40-250	1	3	100L	100	900	490	150	600	440	50	18	839	119	900	490	150	600	440	50	18	936	120
40-315	1	2,2	100L	125	1120	610	190	740	550	50	22	974	160	1120	610	190	740	550	50	22	1071	161
40-315	1	3	100L	125	1120	610	190	740	550	50	22	974	166	1120	610	190	740	550	50	22	1071	167
40-315	1	4	112	125	1120	610	190	740	550	50	22	991	172	1250	540	205	840	490	50	22	1088	178
40-315	1	5,5	132S	125	1120	610	190	740	550	50	22	1050	195	1250	540	205	840	490	50	22	1147	201
40-315	1	7,5	132M	125	1120	610	190	740	550	50	22	1088	203	1250	540	205	840	490	50	22	1185	209

\* For bare shaft pump dimensions please see page 28 and following



### DIMENSIONAL TABLE GS 1450min<sup>-1</sup>

Model	Fig.	Motor		Common* c	Dimensions [mm] Standard coupling								Weight [kg]	Dimensions [mm] Spacer coupling								Weight [kg]
		kW	Frame		A	B	Y	V	E	H	s	T		A	B	Y	V	E	H	s	T	
50-125	1	0,37	71	100	900	390	150	600	350	50	18	711	70	900	390	150	600	350	50	18	808	72
50-125	1	0,55	80	100	900	390	150	600	350	50	18	739	73	900	390	150	600	350	50	18	836	75
50-125	1	0,75	80	100	900	390	150	600	350	50	18	739	75	900	390	150	600	350	50	18	836	77
50-125	1	1,1	90S	100	900	390	150	600	350	50	18	767	80	900	390	150	600	350	50	18	864	82
50-160	1	0,55	80	100	900	490	150	600	440	50	18	739	78	1000	450	170	660	400	50	22	836	82
50-160	1	0,75	80	100	900	490	150	600	440	50	18	739	80	1000	450	170	660	400	50	22	836	84
50-160	1	1,1	90S	100	900	490	150	600	440	50	18	767	85	1000	450	170	660	400	50	22	864	89
50-160	1	1,5	90L	100	900	490	150	600	440	50	18	792	88	1000	450	170	660	400	50	22	889	92
50-160	1	2,2	100L	100	900	490	150	600	440	50	18	839	98	1000	450	170	660	400	50	22	936	101
50-200	1	1,1	90S	100	900	490	150	600	440	50	18	767	96	1000	450	170	660	400	50	22	864	100
50-200	1	1,5	90L	100	900	490	150	600	440	50	18	792	99	1000	450	170	660	400	50	22	889	103
50-200	1	2,2	100L	100	900	490	150	600	440	50	18	839	109	1000	450	170	660	400	50	22	936	112
50-200	1	3	100L	100	900	490	150	600	440	50	18	839	115	1000	450	170	660	400	50	22	936	118
50-200	1	4	112	100	900	490	150	600	440	50	18	856	121	1120	490	190	740	440	50	22	953	131
50-250	1	1,5	90L	100	900	490	150	600	440	50	18	792	105	900	490	150	600	440	50	18	889	107
50-250	1	2,2	100L	100	900	490	150	600	440	50	18	839	115	900	490	150	600	440	50	18	936	116
50-250	1	3	100L	100	900	490	150	600	440	50	18	839	121	900	490	150	600	440	50	18	936	122
50-250	1	4	112	100	900	490	150	600	440	50	18	856	127	1120	490	190	740	440	50	22	953	137
50-250	1	5,5	132S	100	900	490	150	600	440	50	18	915	150	1120	490	190	740	440	50	22	1012	160
50-315	1	3	100L	125	1120	610	190	740	550	50	22	974	170	1120	610	190	740	550	50	22	1071	171
50-315	1	4	112	125	1120	610	190	740	550	50	22	991	176	1250	540	205	840	490	50	22	1088	182
50-315	1	5,5	132S	125	1120	610	190	740	550	50	22	1050	199	1250	540	205	840	490	50	22	1147	205
50-315	1	7,5	132M	125	1120	610	190	740	550	50	22	1088	207	1250	540	205	840	490	50	22	1185	213
50-315	1	11	160M	125	1120	610	190	740	550	50	22	1196	284	1400	610	230	940	550	75	26	1293	285
65-125	1	0,55	80	100	900	490	150	600	440	50	18	739	82	1000	450	170	660	400	50	22	836	86
65-125	1	0,75	80	100	900	490	150	600	440	50	18	739	84	1000	450	170	660	400	50	22	836	88
65-125	1	1,1	90S	100	900	490	150	600	440	50	18	767	89	1000	450	170	660	400	50	22	864	93
65-125	1	1,5	90L	100	900	490	150	600	440	50	18	792	92	1000	450	170	660	400	50	22	889	96
65-160	1	0,75	80	100	900	490	150	600	440	50	18	739	88	1000	450	170	660	400	50	22	836	92
65-160	1	1,1	90S	100	900	490	150	600	440	50	18	767	93	1000	450	170	660	400	50	22	864	97
65-160	1	1,5	90L	100	900	490	150	600	440	50	18	792	96	1000	450	170	660	400	50	22	889	100
65-160	1	2,2	100L	100	900	490	150	600	440	50	18	839	106	1000	450	170	660	400	50	22	936	109
65-200	1	1,1	90S	100	900	490	150	600	440	50	18	767	99	1120	490	190	740	440	50	22	904	110
65-200	1	1,5	90L	100	900	490	150	600	440	50	18	792	102	1120	490	190	740	440	50	22	929	113
65-200	1	2,2	100L	100	900	490	150	600	440	50	18	839	112	1120	490	190	740	440	50	22	976	122
65-200	1	3	100L	100	900	490	150	600	440	50	18	839	118	1120	490	190	740	440	50	22	976	128
65-200	1	4	112	100	900	490	150	600	440	50	18	856	124	1120	490	190	740	440	50	22	993	134
65-200	1	5,5	132S	100	900	490	150	600	440	50	18	915	147	1120	490	190	740	440	50	22	1052	157
65-250	1	2,2	100L	100	1120	610	190	740	550	50	22	949	151	1120	610	190	740	550	50	22	1086	152
65-250	1	3	100L	100	1120	610	190	740	550	50	22	949	157	1120	610	190	740	550	50	22	1086	158
65-250	1	4	112	100	1120	610	190	740	550	50	22	966	163	1250	540	205	840	490	50	22	1103	169
65-250	1	5,5	132S	100	1120	610	190	740	550	50	22	1025	186	1250	540	205	840	490	50	22	1162	192
65-250	1	7,5	132M	100	1120	610	190	740	550	50	22	1063	194	1250	540	205	840	490	50	22	1200	200
65-315	1	5,5	132S	125	1120	610	190	740	550	50	22	1050	203	1400	610	230	940	550	75	26	1187	242
65-315	1	7,5	132M	125	1120	610	190	740	550	50	22	1088	211	1400	610	230	940	550	75	26	1225	250
65-315	1	11	160M	125	1400	610	230	940	550	75	26	1196	288	1400	610	230	940	550	75	26	1333	289
65-315	1	15	160L	125	1400	610	230	940	550	75	26	1240	311	1400	610	230	940	550	75	26	1377	313

\* For bare shaft pump dimensions please see page 28 and following

### DIMENSIONAL TABLE GS 1450min<sup>-1</sup>

Model	Fig.	Motor		Common*	Dimensions [mm]								Weight [kg]	Dimensions [mm]								Weight [kg]
		kW	Frame		Standard coupling									Spacer coupling								
				c	A	B	Y	V	E	H	s	T	A	B	Y	V	E	H	s	T		
80-160	1	0,75	80	125	900	490	150	600	440	50	18	764	93	1120	490	190	740	440	50	22	901	104
80-160	1	1,1	90S	125	900	490	150	600	440	50	18	792	98	1120	490	190	740	440	50	22	929	109
80-160	1	1,5	90L	125	900	490	150	600	440	50	18	817	101	1120	490	190	740	440	50	22	954	112
80-160	1	2,2	100L	125	900	490	150	600	440	50	18	864	111	1120	490	190	740	440	50	22	1001	121
80-160	1	3	100L	125	900	490	150	600	440	50	18	864	117	1120	490	190	740	440	50	22	1001	127
80-160	1	4	112	125	900	490	150	600	440	50	18	881	123	1120	490	190	740	440	50	22	1018	133
80-200	1	2,2	100L	125	1120	610	190	740	550	50	22	974	145	1120	610	190	740	550	50	22	1111	146
80-200	1	3	100L	125	1120	610	190	740	550	50	22	974	151	1120	610	190	740	550	50	22	1111	152
80-200	1	4	112	125	1120	610	190	740	550	50	22	991	157	1120	610	190	740	550	50	22	1128	158
80-200	1	5,5	132S	125	1120	610	190	740	550	50	22	1050	180	1250	540	205	840	490	50	22	1187	186
80-200	1	7,5	132M	125	1120	610	190	740	550	50	22	1088	188	1250	540	205	840	490	50	22	1225	194
80-250	1	3	100L	125	1120	610	190	740	550	50	22	974	161	1120	610	190	740	550	50	22	1111	162
80-250	1	4	112	125	1120	610	190	740	550	50	22	991	167	1120	610	190	740	550	50	22	1128	168
80-250	1	5,5	132S	125	1120	610	190	740	550	50	22	1050	190	1250	540	205	840	490	50	22	1187	196
80-250	1	7,5	132M	125	1120	610	190	740	550	50	22	1088	198	1250	540	205	840	490	50	22	1225	204
80-250	1	11	160M	125	1400	610	230	940	550	75	26	1196	275	1400	610	230	940	550	75	26	1333	276
80-315	1	5,5	132S	125	1120	610	190	740	550	50	22	1050	214	1400	610	230	940	550	75	26	1187	253
80-315	1	7,5	132M	125	1120	610	190	740	550	50	22	1088	222	1400	610	230	940	550	75	26	1225	261
80-315	1	11	160M	125	1400	610	230	940	550	75	26	1196	299	1400	610	230	940	550	75	26	1333	300
80-315	1	15	160L	125	1400	610	230	940	550	75	26	1240	322	1400	610	230	940	550	75	26	1377	324
80-315	1	18,5	180M	125	1400	610	230	940	550	75	26	1262	355	1400	610	230	940	550	75	26	1399	357
80-315	1	22	180L	125	1400	610	230	940	550	75	26	1300	374	1400	610	230	940	550	75	26	1437	377
80-315	1	30	200L	125	1400	730	230	940	670	75	26	1365	431	1400	730	230	940	670	75	26	1502	434
80-400	1	11	160M	125	1400	610	230	940	550	75	26	1256	360	1400	610	230	940	550	75	26	1393	361
80-400	1	15	160L	125	1400	610	230	940	550	75	26	1300	383	1400	610	230	940	550	75	26	1437	385
80-400	1	18,5	180M	125	1400	610	230	940	550	75	26	1322	416	1400	610	230	940	550	75	26	1459	418
80-400	1	22	180L	125	1400	610	230	940	550	75	26	1360	435	1400	610	230	940	550	75	26	1497	438
80-400	1	30	200L	125	1400	730	230	940	670	75	26	1425	492	1800	730	300	1200	670	100	26	1562	532
80-400	1	37	225S	125	1400	730	230	940	670	75	26	1544	630	1800	730	300	1200	670	100	26	1681	672
80-400	1	45	225M	125	1400	730	230	940	670	75	26	1544	665	1800	730	300	1200	670	100	26	1681	707
80-400	1	55	250M	125	1800	730	300	1200	670	100	26	1623	744	1800	730	300	1200	670	100	26	1760	750
100-160	1	2,2	100L	125	1120	610	190	740	550	50	22	974	169	1120	610	190	740	550	50	22	1111	170
100-160	1	3	100L	125	1120	610	190	740	550	50	22	974	175	1120	610	190	740	550	50	22	1111	176
100-160	1	4	112	125	1120	610	190	740	550	50	22	991	181	1120	610	190	740	550	50	22	1128	182
100-160	1	5,5	132S	125	1120	610	190	740	550	50	22	1050	204	1250	540	205	840	490	50	22	1187	210
100-200	1	2,2	100L	125	1120	610	190	740	550	50	22	974	181	1120	610	190	740	550	50	22	1111	182
100-200	1	3	100L	125	1120	610	190	740	550	50	22	974	187	1120	610	190	740	550	50	22	1111	188
100-200	1	4	112	125	1120	610	190	740	550	50	22	991	193	1120	610	190	740	550	50	22	1128	194
100-200	1	5,5	132S	125	1120	610	190	740	550	50	22	1050	216	1250	540	205	840	490	50	22	1187	222
100-200	1	7,5	132M	125	1120	610	190	740	550	50	22	1088	224	1250	540	205	840	490	50	22	1225	230
100-200	1	11	160M	125	1400	610	230	940	550	75	26	1196	301	1400	610	230	940	550	75	26	1333	302
100-250	1	4	112	140	1120	610	190	740	550	50	22	1006	198	1120	610	190	740	550	50	22	1143	199
100-250	1	5,5	132S	140	1120	610	190	740	550	50	22	1065	221	1400	610	230	940	550	75	26	1202	260
100-250	1	7,5	132M	140	1120	610	190	740	550	50	22	1103	229	1400	610	230	940	550	75	26	1240	268
100-250	1	11	160M	140	1400	610	230	940	550	75	26	1211	306	1400	610	230	940	550	75	26	1348	307
100-250	1	15	160L	140	1400	610	230	940	550	75	26	1255	329	1400	610	230	940	550	75	26	1392	331
100-315	1	11	160M	140	1400	610	230	940	550	75	26	1211	307	1400	610	230	940	550	75	26	1348	308
100-315	1	15	160L	140	1400	610	230	940	550	75	26	1255	330	1400	610	230	940	550	75	26	1392	332
100-315	1	18,5	180M	140	1400	610	230	940	550	75	26	1277	363	1400	610	230	940	550	75	26	1414	365
100-315	1	22	180L	140	1400	610	230	940	550	75	26	1315	382	1400	610	230	940	550	75	26	1452	385
100-315	1	30	200L	140	1400	730	230	940	670	75	26	1380	439	1800	730	300	1200	670	100	26	1517	479
100-400	1	15	160L	140	1400	730	230	940	670	75	26	1315	424	1400	730	230	940	670	75	26	1452	426
100-400	1	18,5	180M	140	1400	730	230	940	670	75	26	1337	457	1400	730	230	940	670	75	26	1474	459
100-400	1	22	180L	140	1400	730	230	940	670	75	26	1375	476	1400	730	230	940	670	75	26	1512	479
100-400	1	30	200L	140	1400	730	230	940	670	75	26	1440	519	1800	730	300	1200	670	100	26	1577	559
100-400	1	37	225S	140	1400	730	230	940	670	75	26	1559	657	1800	730	300	1200	670	100	26	1696	699
100-400	1	45	225M	140	1400	730	230	940	670	75	26	1559	692	1800	730	300	1200	670	100	26	1696	734

\* For bare shaft pump dimensions please see page 28 and following

### DIMENSIONAL TABLE GS 1450min<sup>-1</sup>

Model	Fig.	Motor		Common*	Dimensions [mm]								Weight [kg]	Dimensions [mm]								Weight [kg]
		kW	Frame		Standard coupling				Spacer coupling					Spacer coupling								
				c	A	B	Y	V	E	H	s	T	A	B	Y	V	E	H	s	T		
125-200	1	7,5	132M	140	1120	610	190	740	550	50	22	1103	241	1400	610	230	940	550	75	26	1240	280
125-200	1	11	160M	140	1400	610	230	940	550	75	26	1211	318	1400	610	230	940	550	75	26	1348	319
125-200	1	15	160L	140	1400	610	230	940	550	75	26	1255	341	1400	610	230	940	550	75	26	1392	343
125-250	1	7,5	132M	140	1120	610	190	740	550	50	22	1103	252	1400	610	230	940	550	75	26	1240	291
125-250	1	11	160M	140	1400	610	230	940	550	75	26	1211	329	1400	610	230	940	550	75	26	1348	330
125-250	1	15	160L	140	1400	610	230	940	550	75	26	1255	352	1400	610	230	940	550	75	26	1392	354
125-250	1	18,5	180M	140	1400	610	230	940	550	75	26	1277	385	1400	610	230	940	550	75	26	1414	387
125-250	1	22	180L	140	1400	610	230	940	550	75	26	1315	404	1400	610	230	940	550	75	26	1452	407
125-250	1	30	200L	140	1400	730	230	940	670	75	26	1380	461	1800	730	300	1200	670	100	26	1517	501
125-315	1	15	160L	140	1400	730	230	940	670	75	26	1315	411	1400	730	230	940	670	75	26	1452	413
125-315	1	18,5	180M	140	1400	730	230	940	670	75	26	1337	444	1400	730	230	940	670	75	26	1474	446
125-315	1	22	180L	140	1400	730	230	940	670	75	26	1375	463	1400	730	230	940	670	75	26	1512	466
125-315	1	30	200L	140	1400	730	230	940	670	75	26	1440	506	1800	730	300	1200	670	100	26	1577	546
125-315	1	37	225S	140	1400	730	230	940	670	75	26	1559	644	1800	730	300	1200	670	100	26	1696	686
125-315	1	45	225M	140	1400	730	230	940	670	75	26	1559	679	1800	730	300	1200	670	100	26	1696	721
125-400	1	30	200L	140	1400	730	230	940	670	75	26	1440	548	1800	730	300	1200	670	100	26	1577	588
125-400	1	37	225S	140	1400	730	230	940	670	75	26	1559	686	1800	730	300	1200	670	100	26	1696	728
125-400	1	45	225M	140	1400	730	230	940	670	75	26	1559	721	1800	730	300	1200	670	100	26	1696	763
125-400	1	55	250M	140	1800	730	300	1200	670	100	26	1638	800	1800	730	300	1200	670	100	26	1775	806
125-400	1	75	280S	140	1800	850	300	1200	780	100	26	1744	1012	1800	850	300	1200	780	100	26	1881	1019
125-500	1	37	225S	240	1780	820	170	720	770	140	18	1739	886	1960	820	190	790	770	140	18	1876	897
125-500	1	45	225M	240	1780	820	170	720	770	140	18	1739	921	1960	820	190	790	770	140	18	1876	932
125-500	1	55	250M	240	1900	820	190	760	770	140	18	1818	967	2080	820	210	830	770	140	18	1955	979
125-500	1	75	280S	240	1980	820	190	800	770	140	18	1924	1160	2150	820	210	865	770	140	18	2061	1172
125-500	1	90	280M	240	1980	820	190	800	770	140	18	1924	1235	2150	820	210	865	770	140	18	2061	1248
150-200	1	7,5	132M	160	1400	730	230	940	670	75	26	1123	327	1400	730	230	940	670	75	26	1260	328
150-200	1	11	160M	160	1400	730	230	940	670	75	26	1231	366	1400	730	230	940	670	75	26	1368	367
150-200	1	15	160L	160	1400	730	230	940	670	75	26	1275	389	1400	730	230	940	670	75	26	1412	391
150-200	1	18,5	180M	160	1400	730	230	940	670	75	26	1297	422	1400	730	230	940	670	75	26	1434	424
150-250	1	15	160L	160	1400	730	230	940	670	75	26	1335	406	1400	730	230	940	670	75	26	1472	408
150-250	1	18,5	180M	160	1400	730	230	940	670	75	26	1357	439	1400	730	230	940	670	75	26	1494	441
150-250	1	22	180L	160	1400	730	230	940	670	75	26	1395	458	1400	730	230	940	670	75	26	1532	461
150-250	1	30	200L	160	1400	730	230	940	670	75	26	1460	501	1800	730	300	1200	670	100	26	1597	541
150-250	1	37	225S	160	1400	730	230	940	670	75	26	1579	639	1800	730	300	1200	670	100	26	1716	681
150-315	1	18,5	180M	160	1400	730	230	940	670	75	26	1357	493	1400	730	230	940	670	75	26	1494	495
150-315	1	22	180L	160	1400	730	230	940	670	75	26	1395	512	1800	730	300	1200	670	100	26	1532	552
150-315	1	30	200L	160	1400	730	230	940	670	75	26	1460	555	1800	730	300	1200	670	100	26	1597	595
150-315	1	37	225S	160	1800	730	300	1200	670	100	26	1579	730	1800	730	300	1200	670	100	26	1716	735
150-315	1	45	225M	160	1800	730	300	1200	670	100	26	1579	765	1800	730	300	1200	670	100	26	1716	770
150-315	1	55	250M	160	1800	730	300	1200	670	100	26	1658	807	1800	730	300	1200	670	100	26	1795	813
150-315	1	75	280S	160	1800	850	300	1200	780	100	26	1764	1014	1800	850	300	1200	780	100	26	1901	1020
150-400	1	45	225M	160	1800	730	300	1200	670	100	26	1579	879	1800	730	300	1200	670	100	26	1716	884
150-400	1	55	250M	160	1800	730	300	1200	670	100	26	1658	921	1800	730	300	1200	670	100	26	1795	927
150-400	1	75	280S	160	1800	850	300	1200	780	100	26	1764	1133	1800	850	300	1200	780	100	26	1901	1140
150-400	1	90	280M	160	1800	850	300	1200	780	100	26	1764	1203	1800	850	300	1200	780	100	26	1901	1210
150-500	1	75	280S	240	1980	820	190	800	770	140	18	1924	1286	2150	820	210	865	770	140	18	2101	1299
150-500	1	90	280M	240	1980	820	190	800	770	140	18	1924	1361	2150	820	210	865	770	140	18	2101	1375
150-500	2	110	315S	245	2120	830	210	850	770	160	20	2127	1653	2300	830	230	920	770	160	20	2304	1671
150-500	2	132	315M	245	2120	830	210	850	770	160	20	2127	1713	2300	830	230	920	770	160	20	2304	1731
150-500	2	160	315L	245	2260	830	230	900	770	160	20	2127	1789	2440	830	250	970	770	160	20	2304	1807
200-400	1	75	280S	290	1980	740	190	800	690	140	18	1924	1322	2150	740	210	865	690	140	18	2101	1336
200-400	1	90	280M	290	1980	740	190	800	690	140	18	1924	1397	2150	740	210	865	690	140	18	2101	1412
200-400	2	110	315S	295	2120	820	210	850	760	160	20	2127	1669	2300	820	230	920	760	160	20	2304	1686
200-400	2	132	315M	295	2120	820	210	850	760	160	20	2127	1729	2300	820	230	920	760	160	20	2304	1746
200-400	2	160	315L	295	2260	820	230	900	760	160	20	2127	1805	2440	820	250	970	760	160	20	2304	1822
200-400	2	200	315L	295	2260	820	230	900	760	160	20	2127	1930	2440	820	250	970	760	160	20	2304	1951
200-500	2	160	315L	315	2280	850	230	910	790	160	20	2297	1946	2460	850	250	980	790	160	20	2474	1964
200-500	2	200	315L	315	2280	850	230	910	790	160	20	2297	2071	2460	850	250	980	790	160	20	2474	2093
200-500	2	250	355L	315	2400	870	250	950	810	160	20	2505	2318	2580	870	250	1040	810	160	20	2682	2345
200-500	2	315	355L	315	2400	870	250	950	810	160	20	2505	2638	2580	870	250	1040	810	160	20	2682	2665
200-500	2	355	355L	320	2640	980	270	1050	920	180	20	2505	2827	2810	980	290	1115	920	180	20	2682	2855

DIMENSIONS OF BARE SHAFT PUMP

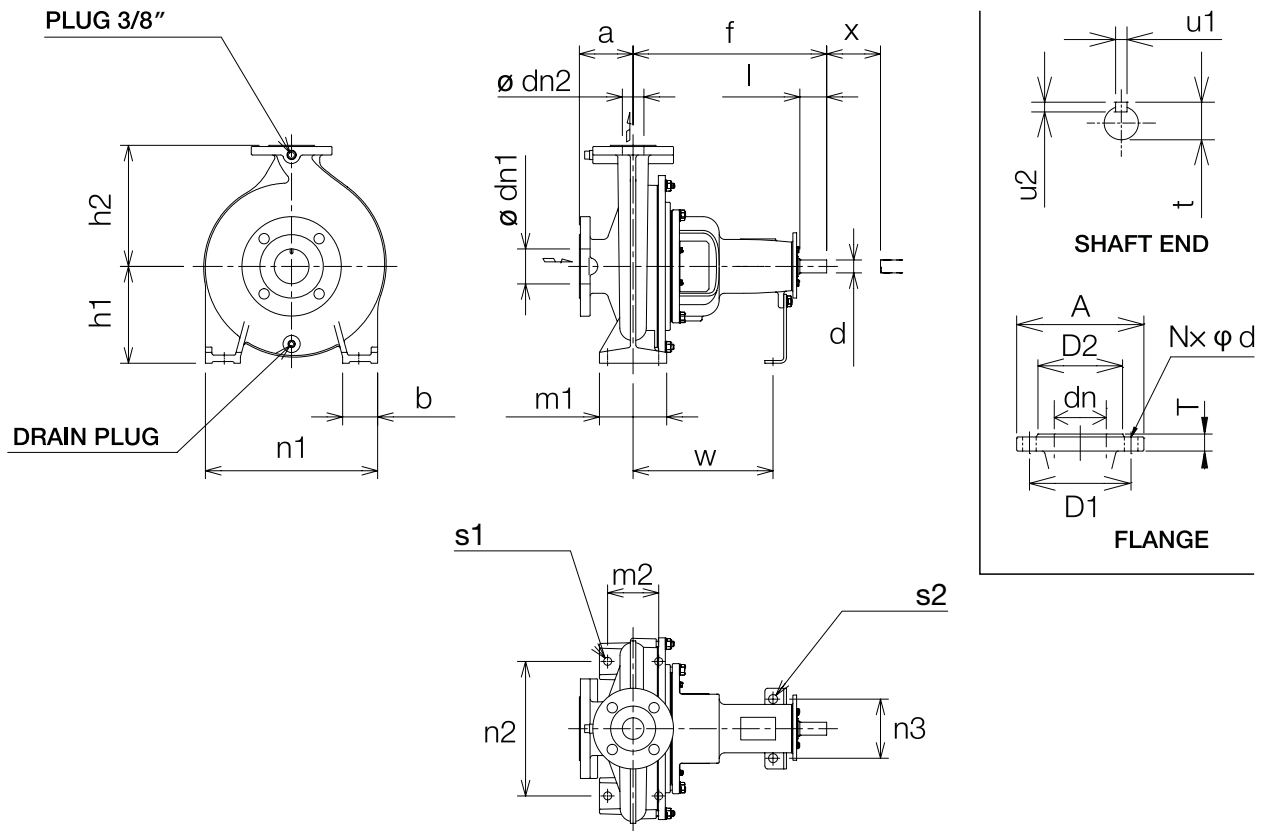

Model	Dimensions [mm]														
	Suction flange							Discharge flange							
	dn1	A	D1	D2	T	N	d	dn2	A	D1	D2	T	N	d	
GS32	50	165	125	99	20	4	19	32	140	100	76	18	4	19	
GS40	65	185	145	118	20	4	19	40	150	110	84	18	4	19	

Model	Pump							Support					Holes for Bolts		Shaft End					Weight [kg]			
	$\varnothing$ dn1	$\varnothing$ dn2	a	f	h1	h2	Drain plug	b	m1	m2	n1	n2	n3	W	s1	s2	d	l	t		u1	u2	X
GS32-125.1	50	32	80	360	112	140	1/4"	50	100	70	190	140	110	260	M12	M12	24	50	27	8	7	100	28
GS32-160.1	50	32	80	360	132	160	1/4"	50	100	70	240	190	110	260	M12	M12	24	50	27	8	7	100	29
GS32-200.1	50	32	80	360	160	180	1/4"	50	100	70	240	190	110	260	M12	M12	24	50	27	8	7	100	39
GS32-125	50	32	80	360	112	140	1/4"	50	100	70	190	140	110	260	M12	M12	24	50	27	8	7	100	28
GS32-160	50	32	80	360	132	160	1/4"	50	100	70	240	190	110	260	M12	M12	24	50	27	8	7	100	29
GS32-200	50	32	80	360	160	180	1/4"	50	100	70	240	190	110	260	M12	M12	24	50	27	8	7	100	39
GS32-250	50	32	100	360	180	225	1/4"	65	125	95	320	250	110	260	M12	M12	24	50	27	8	7	100	46
GS40-125	65	40	80	360	112	140	1/4"	50	100	70	210	160	110	260	M12	M12	24	50	27	8	7	100	30
GS40-160	65	40	80	360	132	160	1/4"	50	100	70	240	190	110	260	M12	M12	24	50	27	8	7	100	31
GS40-200	65	40	100	360	160	180	1/4"	50	100	70	265	212	110	260	M12	M12	24	50	27	8	7	100	41
GS40-250	65	40	100	360	180	225	1/4"	65	125	95	320	250	110	260	M12	M12	24	50	27	8	7	100	48
GS40-315	65	40	125	470	225	250	1/4"	65	125	95	345	280	110	340	M12	M12	32	80	35	10	8	100	82

### DIMENSIONS OF BARE SHAFT PUMP

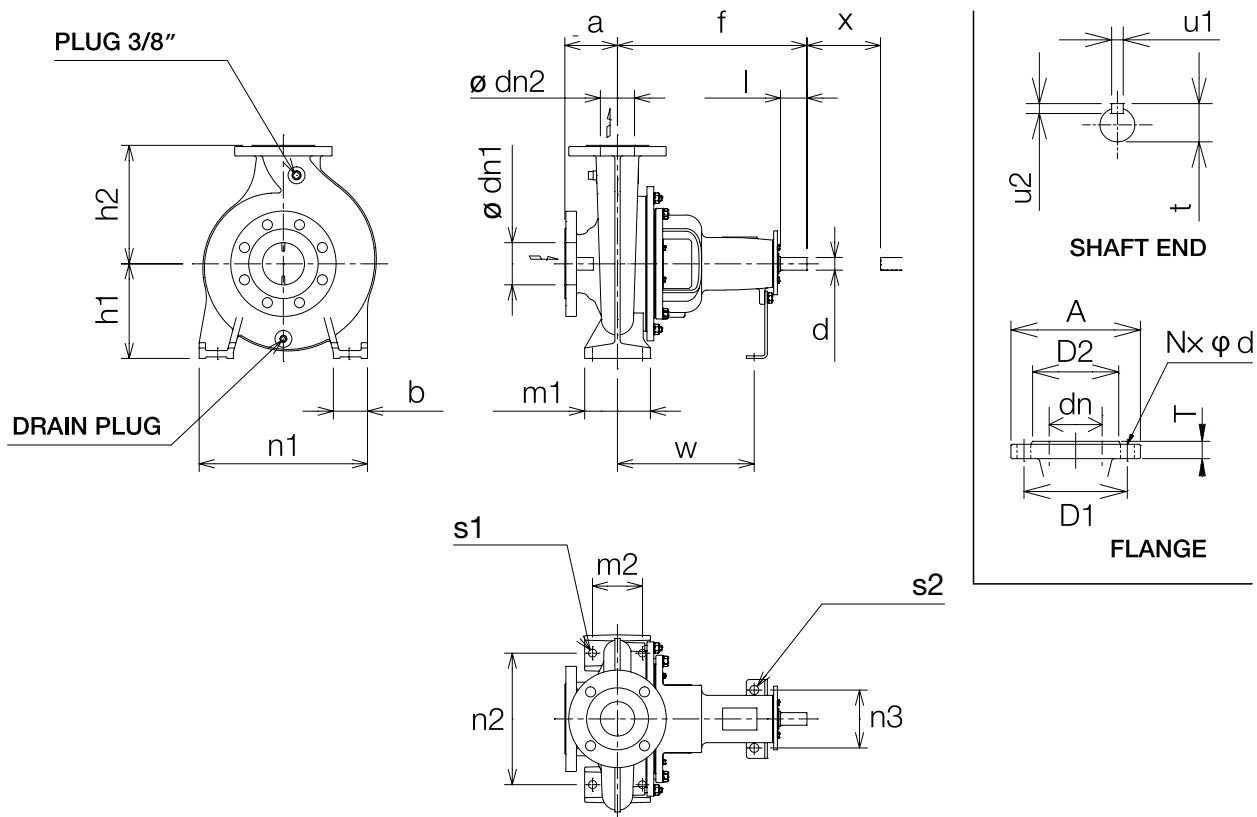

DIMENSIONS

Model	Dimensions [mm]													
	Suction flange							Discharge flange						
	dn1	A	D1	D2	T	N	d	dn2	A	D1	D2	T	N	d
GS50	65	185	145	118	20	4	19	50	165	125	99	20	4	19
GS65	80	200	160	132	22	8	19	65	185	145	118	20	4	19
GS80	100	220	180	156	24	8	19	80	200	160	132	22	8	19

Model	Pump		Support										Holes for Bolts		Shaft End					Weight [kg]			
	$\varnothing$ dn1	$\varnothing$ dn2	a	f	h1	h2	Drain plug	b	m1	m2	n1	n2	n3	W	s1	s2	d	l	t		u1	u2	X
GS50-125	65	50	100	360	132	160	1/4"	50	100	70	240	190	110	260	M12	M12	24	50	27	8	7	100	33
GS50-160	65	50	100	360	160	180	1/4"	50	100	70	265	212	110	260	M12	M12	24	50	27	8	7	100	33
GS50-200	65	50	100	360	160	200	1/4"	50	100	70	265	212	110	260	M12	M12	24	50	27	8	7	100	44
GS50-250	65	50	100	360	180	225	1/4"	65	125	95	320	250	110	260	M12	M12	24	50	27	8	7	100	50
GS50-315	65	50	125	470	225	280	1/4"	65	125	95	345	280	110	340	M12	M12	32	80	35	10	8	100	86
GS65-125	80	65	100	360	160	180	1/4"	65	125	95	280	212	110	260	M12	M12	24	50	27	8	7	100	37
GS65-160	80	65	100	360	160	200	1/4"	65	125	95	280	212	110	260	M12	M12	24	50	27	8	7	100	41
GS65-200	80	65	100	360	180	225	1/4"	65	125	95	320	250	110	260	M12	M12	24	50	27	8	7	140	47
GS65-250	80	65	100	470	200	250	1/4"	80	160	120	360	280	110	340	M16	M12	32	80	35	10	8	140	73
GS65-315	80	65	125	470	225	280	1/4"	80	160	120	400	315	110	340	M16	M12	32	80	35	10	8	140	90
GS80-160	100	80	125	360	180	225	1/4"	65	125	95	320	250	110	260	M12	M12	24	50	27	8	7	140	46
GS80-200	100	80	125	470	180	250	1/4"	65	125	95	345	280	110	340	M12	M12	32	80	35	10	8	140	67
GS80-250	100	80	125	470	200	280	1/4"	80	160	120	400	315	110	340	M16	M12	32	80	35	10	8	140	77
GS80-315	100	80	125	470	250	315	1/4"	80	160	120	400	315	110	340	M16	M12	32	80	35	10	8	140	101
GS80-315L	100	80	125	530	250	315	1/4"	80	160	120	400	315	110	370	M16	M12	42	110	45	12	8	140	112
GS80-400	100	80	125	530	280	355	1/4"	80	160	120	435	355	110	370	M16	M12	42	110	45	12	8	140	162

DIMENSIONS OF BARE SHAFT PUMP

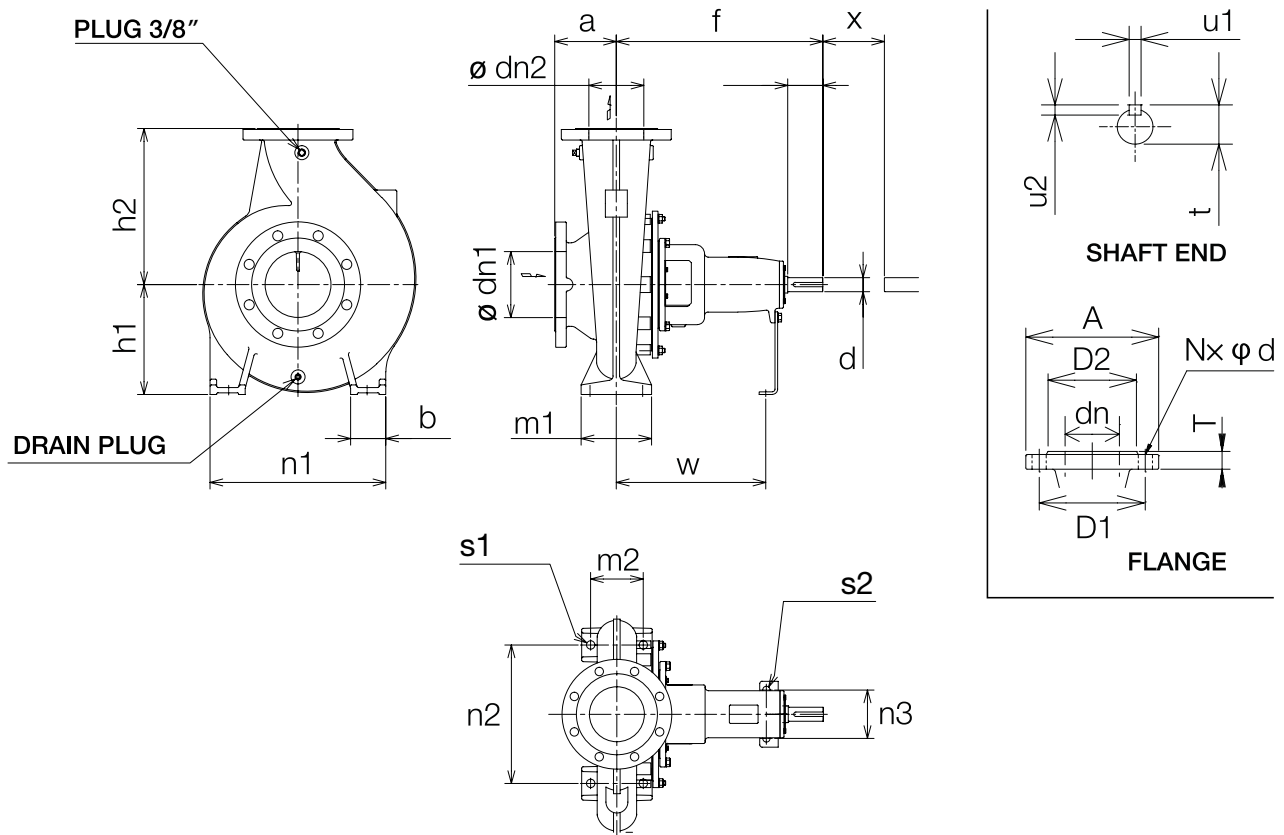

Model	Dimensions [mm]														
	Suction flange							Discharge flange							
	dn1	A	D1	D2	T	N	d	dn2	A	D1	D2	T	N	d	
GS100	125	250	210	184	26	8	19	100	220	180	156	24	8	19	
GS125	150	285	240	211	26	8	23	125	250	210	184	26	8	19	
GS150	200	340	295	266	30	12	23	150	285	240	211	26	8	23	
GS200	250	405	355	319	32	12	28	200	340	295	266	30	12	23	

Model	Pump																			Support		Holes for Bolts		Shaft End					Weight [kg]
	ø dn1	ø dn2	a	f	h1	h2	Drain plug	b	m1	m2	n1	n2	n3	W	s1	s2	d	l	t	u1	u2	X							
GS100-160	125	100	125	470	200	250	3/8"	80	160	120	360	280	110	340	M16	M12	32	80	35	10	8	140	91						
GS100-200	125	100	125	470	200	280	3/8"	80	160	120	360	280	110	340	M16	M12	32	80	35	10	8	140	103						
GS100-250	125	100	140	470	225	280	3/8"	80	160	120	400	315	110	340	M16	M12	32	80	35	10	8	140	108						
GS100-250L	125	100	140	530	225	280	3/8"	80	160	120	400	315	110	370	M16	M12	42	110	45	12	8	140	120						
GS100-315	125	100	140	470	250	315	3/8"	80	160	120	400	315	110	340	M16	M12	32	80	35	10	8	140	109						
GS100-315L	125	100	140	530	250	315	3/8"	80	160	120	400	315	110	370	M16	M12	42	110	45	12	8	140	134						
GS100-400	125	100	140	530	280	355	3/8"	100	200	150	500	400	110	370	M20	M12	42	110	45	12	8	140	189						
GS125-200	150	125	140	470	250	315	3/8"	80	160	120	400	315	110	340	M16	M12	32	80	35	10	8	140	120						
GS125-250	150	125	140	470	250	355	3/8"	80	160	120	400	315	110	340	M16	M12	32	80	35	10	8	140	131						
GS125-250L	150	125	140	530	250	355	3/8"	80	160	120	400	315	110	370	M16	M12	42	110	45	12	8	140	148						
GS125-315	150	125	140	530	280	355	3/8"	100	200	150	500	400	110	370	M20	M12	42	110	45	12	8	140	176						
GS125-400	150	125	140	530	315	400	3/8"	100	200	150	500	400	110	370	M20	M12	42	110	45	12	8	140	218						
GS125-500	150	125	180	670	375	450	3/8"	100	200	150	550	450	140	500	M20	M16	48	110	51,5	14	9	140	365						
GS150-200	200	150	160	470	280	355	3/8"	100	200	150	500	400	110	340	M20	M12	32	80	35	10	8	140	154						
GS150-250	200	150	160	530	280	375	3/8"	100	200	150	500	400	110	370	M20	M12	42	110	45	12	8	140	171						
GS150-315	200	150	160	530	315	400	3/8"	100	200	150	550	450	110	370	M20	M12	42	110	45	12	8	140	225						
GS150-400	200	150	160	530	315	450	1/2"	100	200	150	550	450	110	370	M20	M12	42	110	45	12	8	140	339						
GS150-400L	200	150	160	670	315	450	1/2"	100	200	150	550	450	140	500	M20	M16	48	110	51,5	14	9	140	363						
GS150-500	200	150	180	670	375	560	1/2"	100	200	150	550	450	140	500	M20	M16	60	110	64	18	11	180	491						
GS200-400	250	200	180	670	385	560	1/2"	100	315	250	660	560	140	500	M20	M16	60	110	64	18	11	180	508						
GS200-500	250	200	200	820	435	630	1/2"	100	315	250	660	560	160	630	M24	M16	75	125	79,5	20	12	180	645						

### PERFORMANCE RANGE 2900min<sup>-1</sup>

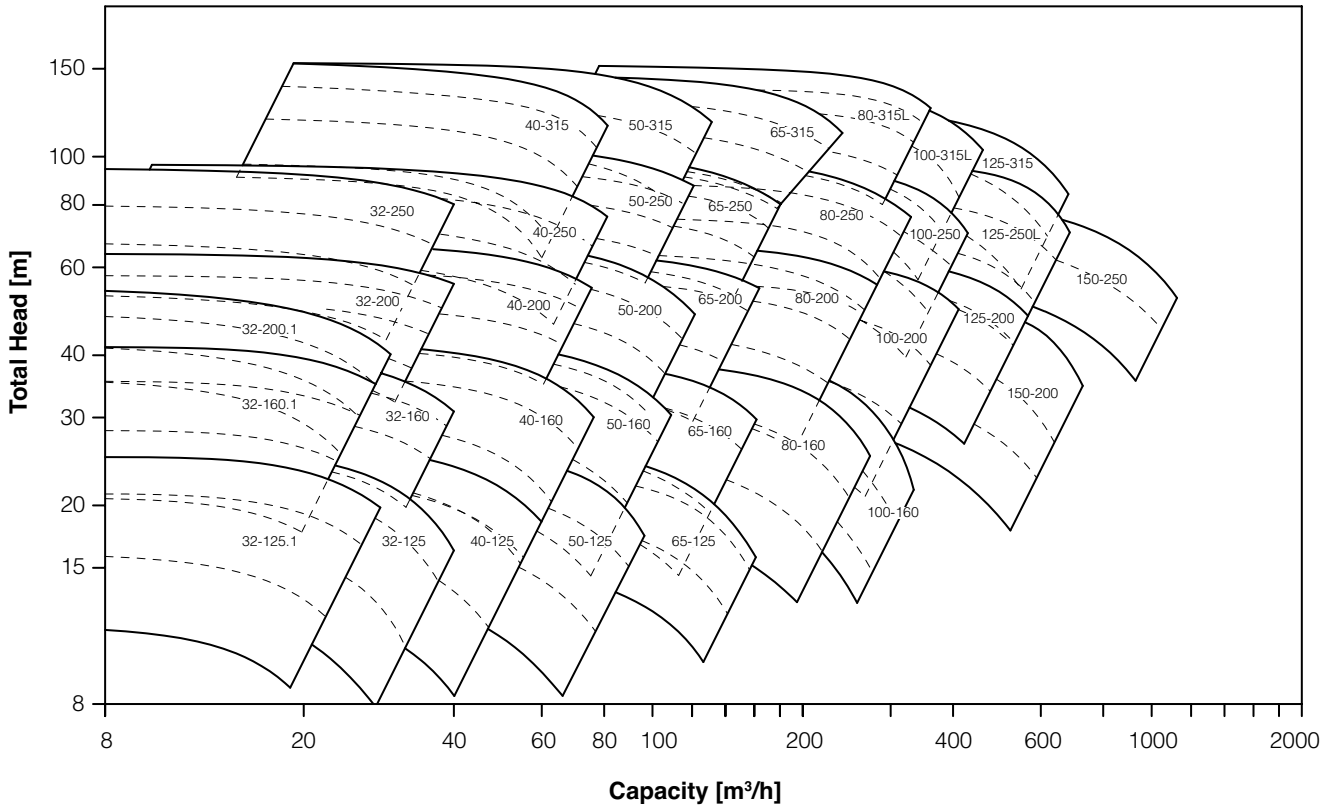

SELECTION CHART

**PERFORMANCE TABLE**  
2900min<sup>-1</sup>

Model	Diameter	Q = Flow rate								
		m <sup>3</sup> /h 0	6	12	18	24	30	36	42	48
		l/min 0	100	200	300	400	500	600	700	800
		H = Head [m]								
GS 32-125.1	100	11,5	11,4	10,7	9,0	-	-	-	-	-
GS 32-125.1	115	15,9	15,8	15,2	13,7	-	-	-	-	-
GS 32-125.1	129	21,0	21,0	20,8	19,8	17,7	-	-	-	-
GS 32-125.1	140	24,8	24,8	24,7	23,9	22,0	-	-	-	-
GS 32-160.1	126	20,4	20,2	19,9	19,3	-	-	-	-	-
GS 32-160.1	145	28,2	28,2	28,0	26,8	24,1	-	-	-	-
GS 32-160.1	163	35,3	35,3	35,1	33,9	31,5	27,9	-	-	-
GS 32-160.1	177	41,7	41,6	41,3	40,1	37,7	33,6	-	-	-
GS 32-200.1	172	36,3	35,6	34,5	30,5	25,0	-	-	-	-
GS 32-200.1	184	42,2	42,0	40,2	36,7	32,5	23,8	-	-	-
GS 32-200.1	196	48,5	48,5	46,5	43,7	38,5	32,3	-	-	-
GS 32-200.1	207	54,3	54,0	52,6	50,0	45,8	39,8	31,2	-	-
GS 32-125	106	13,6	13,6	12,9	11,5	9,3	-	-	-	-
GS 32-125	119	18,0	20,2	19,9	16,0	14,4	11,8	-	-	-
GS 32-125	131	22,4	22,4	22,1	21,5	20,0	18,0	-	-	-
GS 32-125	142	25,8	25,7	25,5	25,0	23,8	21,7	18,9	-	-
GS 32-160	139	25,3	25,2	25,0	24,3	22,9	-	-	-	-
GS 32-160	152	30,7	30,7	30,6	30,0	29,1	-	-	-	-
GS 32-160	164	36,1	36,1	35,9	35,4	34,3	30,2	-	-	-
GS 32-160	177	40,9	40,8	40,3	39,9	38,1	36,2	33,5	-	-
GS 32-200	175	40,1	40,1	39,8	38,5	36,8	33,7	30,0	-	-
GS 32-200	184	44,4	44,4	44,0	43,2	41,7	39,3	33,7	-	-
GS 32-200	197	51,3	51,3	51,0	50,3	48,9	47,0	43,8	40,1	-
GS 32-200	208	57,7	57,7	57,4	56,5	55,3	53,7	50,4	48,5	44,2
GS 32-200	219	63,8	63,8	63,6	62,9	61,5	59,9	58,1	52,9	50,1
GS 32-250	198	53,1	52,9	52,0	49,5	46,7	-	-	-	-
GS 32-250	222	67,1	67,0	65,8	64,4	61,6	57,5	52,4	-	-
GS 32-250	241	79,7	79,7	79,0	76,8	74,9	71,6	67,1	-	-
GS 32-250	262	94,5	94,5	93,9	92,5	90,6	87,2	83,0	-	-



### PERFORMANCE TABLE 2900min<sup>-1</sup>

Model	Diameter	Q = Flow rate																		
		m <sup>3</sup> /h 0	6	12	18	24	30	36	42	48	54	60	66	72	78	84	90	102	114	126
		l/min 0	100	200	300	400	500	600	700	800	900	1000	1100	1200	1300	1400	1500	1700	1900	2100
		H = Head [m]																		
GS 40-125	105	13,4	13,3	13,1	12,6	11,9	10,7	9,3	8,8	-	-	-	-	-	-	-	-	-	-	-
GS 40-125	119	18,0	18,0	17,8	17,3	16,7	15,7	14,5	13,0	11,0	-	-	-	-	-	-	-	-	-	-
GS 40-125	131	22,6	22,6	22,5	22,3	22,0	21,3	20,5	19,2	17,9	16,1	-	-	-	-	-	-	-	-	-
GS 40-125	142	26,8	26,7	26,6	26,2	25,9	25,5	24,7	23,5	22,1	20,5	-	-	-	-	-	-	-	-	-
GS 40-160	134	23,8	-	23,8	23,5	22,5	21,8	20,6	19,5	17,6	16,0	-	-	-	-	-	-	-	-	-
GS 40-160	150	30,4	-	30,1	29,8	29,4	28,7	28,0	26,8	25,5	23,7	21,5	-	-	-	-	-	-	-	-
GS 40-160	163	36,6	-	36,5	36,3	36,1	35,7	35,0	34,2	33,0	31,9	30,2	28,1	-	-	-	-	-	-	-
GS 40-160	177	42,8	-	42,4	42,2	42,0	41,5	40,9	40,1	39,1	37,9	36,3	34,3	32,0	-	-	-	-	-	-
GS 40-200	172	41,2	-	41,2	41,1	40,9	40,5	40,1	39,2	37,8	36,8	35,3	-	-	-	-	-	-	-	-
GS 40-200	189	50,0	-	50,0	49,8	49,6	49,2	48,6	47,8	46,5	45,6	44,0	41,9	-	-	-	-	-	-	-
GS 40-200	205	59,2	-	59,2	59,1	58,8	58,3	57,7	57,1	56,2	55,0	53,5	51,3	49,9	-	-	-	-	-	-
GS 40-200	219	66,8	-	66,7	66,6	66,4	66,0	65,1	64,8	63,2	62,3	60,2	58,7	56,2	-	-	-	-	-	-
GS 40-250	211	62,6	-	62,5	62,3	61,2	60,1	59,2	56,8	54,6	51,8	48,4	-	-	-	-	-	-	-	-
GS 40-250	228	73,6	-	73,6	73,4	72,6	71,7	70,5	68,2	66,6	64,4	61,8	58,0	-	-	-	-	-	-	-
GS 40-250	245	85,6	-	85,5	85,2	84,8	84,0	82,6	81,0	79,7	77,5	75,7	72,1	68,2	-	-	-	-	-	-
GS 40-250	260	96,0	-	96,0	95,8	95,6	94,8	93,4	92,2	91,0	89,1	87,5	84,2	81,4	78,2	-	-	-	-	-
GS 40-315	265	92,3	-	91,2	90,3	88,5	87,4	85,6	81,7	78,5	70,1	63,8	-	-	-	-	-	-	-	-
GS 40-315	273	98,0	-	96,6	96,0	95,1	93,6	91,7	88,1	84,6	79,5	70,5	-	-	-	-	-	-	-	-
GS 40-315	300	120,3	-	119,5	118,6	117,4	116,0	114,7	113,5	109,8	105,2	99,9	90,3	-	-	-	-	-	-	-
GS 40-315	322	140,0	-	139,5	138,1	136,6	135,1	133,8	131,5	128,6	126,2	123,2	119,5	112,0	-	-	-	-	-	-
GS 40-315	338	155,4	-	153,4	152,8	152,1	151,5	149,5	146,3	144,4	142,1	137,6	135,2	128,0	-	-	-	-	-	-
GS 50-125	111	14,8	-	14,1	13,9	13,5	13,2	12,7	11,9	11,3	10,2	9,4	-	-	-	-	-	-	-	-
GS 50-125	123	18,3	-	18,2	18,1	17,8	17,5	16,9	16,4	15,9	15,0	14,1	13,0	-	-	-	-	-	-	-
GS 50-125	134	22,8	-	-	22,5	22,3	22,2	21,9	21,6	21,2	20,5	20,0	19,2	18,3	17,4	16,1	-	-	-	-
GS 50-125	144	26,7	-	-	26,3	26,1	25,9	25,7	25,4	25,1	24,7	24,3	23,7	22,9	22,0	20,7	-	-	-	-
GS 50-160	131	22,2	-	-	22,1	21,7	21,4	20,9	20,1	19,5	18,4	17,8	16,5	-	-	-	-	-	-	-
GS 50-160	148	29,8	-	-	29,8	29,6	29,2	28,8	28,2	27,7	27,1	26,2	25,4	24,1	23,0	-	-	-	-	-
GS 50-160	164	37,6	-	-	37,6	37,5	37,3	37,1	36,8	36,4	35,8	35,2	34,5	33,6	32,4	31,5	30,1	-	-	-
GS 50-160	177	43,9	-	-	43,7	43,6	43,3	43,0	42,5	41,9	41,3	40,6	40,0	39,1	38,0	36,8	35,7	32,6	-	-
GS 50-200	171	40,8	-	-	-	40,7	40,6	40,4	40,1	39,9	39,8	39,5	38,5	37,3	36,0	34,7	32,5	31,2	-	-
GS 50-200	188	49,7	-	-	-	49,6	49,6	49,5	49,2	49,0	48,1	47,7	46,7	45,9	44,8	43,9	42,2	38,3	-	-
GS 50-200	203	58,5	-	-	-	58,5	58,5	58,0	57,8	57,4	56,8	56,1	55,5	54,7	53,8	52,4	50,7	48,0	43,7	-
GS 50-200	219	67,1	-	-	-	67,1	67,1	67,1	66,9	66,3	66,0	65,3	64,6	63,7	62,7	61,4	59,8	56,0	51,5	-
GS 50-250	210	65,0	-	-	-	64,6	64,6	64,5	64,3	64,0	63,4	62,8	61,9	61,2	60,4	59,1	57,3	-	-	-
GS 50-250	221	71,9	-	-	-	71,7	71,7	71,5	71,3	71,1	70,8	70,4	70,0	69,5	68,3	67,6	66,1	-	-	-
GS 50-250	238	83,5	-	-	-	83,5	83,4	83,2	82,9	82,5	82,0	81,3	80,7	80,2	79,5	78,7	77,5	74,6	-	-
GS 50-250	254	94,5	-	-	-	94,2	94,1	93,9	93,6	93,4	93,2	92,5	92,0	91,1	90,4	89,5	88,0	85,3	-	-
GS 50-250	270	105,3	-	-	-	105,2	105,1	104,9	104,7	104,2	103,7	102,7	101,9	101,3	100,5	99,3	97,5	93,8	91,5	-
GS 50-315	277	106,2	-	-	-	105,6	105,4	105,1	103,9	102,5	101,8	100,4	99,2	97,6	96,0	93,4	90,5	84,9	76,2	-
GS 50-315	302	127,0	-	-	-	126,5	126,3	126,1	125,8	125,3	124,8	124,1	123,0	122,1	120,6	119,3	117,3	113,1	105,7	96,0
GS 50-315	324	154,7	-	-	-	153,4	153,3	152,9	152,5	152,0	150,8	149,9	148,7	147,5	145,9	144,0	139,8	136,2	129,4	120,8

**PERFORMANCE TABLE**  
2900min<sup>-1</sup>

SELECTION CHART

Model	Diameter	Q = Flow rate																								
		m³/h 0	30	48	54	60	66	72	78	84	90	102	114	120	132	150	180	210	240	270	300	330	360	390	420	
		l/min 0	500	800	900	1000	1100	1200	1300	1400	1500	1700	1900	2000	2200	2500	3000	3500	4000	4500	5000	5500	6000	6500	7000	
		H = Head [m]																								
GS 65-125	120	16,8	16,1	15,4	15,1	14,9	14,4	14,2	13,8	13,3	12,9	12,2	11,0	-	-	-	-	-	-	-	-	-	-	-	-	
GS 65-125	130	19,9	19,8	19,4	19,2	18,9	18,7	18,4	18,1	17,7	17,4	16,5	15,4	14,8	13,6	-	-	-	-	-	-	-	-	-	-	
GS 65-125	139	23,2	23,1	23,1	23,0	22,9	22,8	22,6	22,4	22,3	22,0	21,3	20,4	19,8	18,5	-	-	-	-	-	-	-	-	-	-	
GS 65-125	147	26,5	26,3	26,1	25,9	25,8	25,6	25,4	25,1	24,8	24,5	23,6	22,5	21,8	20,3	17,6	-	-	-	-	-	-	-	-	-	
GS 65-160	135	22,5	20,8	20,1	19,6	19,4	19,2	18,6	18,2	17,7	17,1	15,9	14,3	13,7	-	-	-	-	-	-	-	-	-	-	-	
GS 65-160	150	27,9	27,1	26,3	26,1	26,0	25,7	25,4	24,9	24,3	24,0	22,9	21,4	20,7	19,1	-	-	-	-	-	-	-	-	-	-	
GS 65-160	165	34,4	34,0	33,7	33,6	33,4	33,2	33,0	32,7	32,5	32,1	31,7	30,6	30,1	28,8	-	-	-	-	-	-	-	-	-	-	
GS 65-160	177	40,0	39,6	39,0	38,8	38,6	38,4	38,1	38,0	37,8	37,7	37,0	36,1	35,6	34,2	31,9	-	-	-	-	-	-	-	-	-	
GS 65-200	162	34,5	34,5	34,5	34,3	34,0	33,7	33,3	33,1	32,8	32,4	31,3	30,1	29,8	-	-	-	-	-	-	-	-	-	-	-	
GS 65-200	183	44,3	44,3	44,2	44,2	44,1	44,0	43,7	43,4	43,1	42,7	42,1	41,7	41,2	40,0	-	-	-	-	-	-	-	-	-	-	
GS 65-200	203	55,4	55,4	55,4	55,3	55,3	55,1	55,0	54,9	54,9	54,8	54,6	54,3	52,9	-	-	-	-	-	-	-	-	-	-	-	
GS 65-200	219	63,7	63,7	63,7	63,6	63,5	63,4	63,2	63,0	62,8	62,6	61,9	60,8	60,3	59,2	-	-	-	-	-	-	-	-	-	-	
GS 65-250	215	61,7	61,6	61,4	61,1	61,0	60,7	60,5	60,2	59,8	59,5	58,5	57,3	55,8	55,0	-	-	-	-	-	-	-	-	-	-	
GS 65-250	237	74,9	74,9	74,9	74,9	74,8	74,6	74,5	74,2	73,8	73,1	72,1	71,3	69,5	65,8	-	-	-	-	-	-	-	-	-	-	
GS 65-250	254	86,6	86,5	86,5	86,3	86,0	85,9	85,7	85,6	85,3	84,9	84,3	83,4	83,0	81,3	78,8	-	-	-	-	-	-	-	-	-	
GS 65-250	273	100,4	100,4	100,4	100,3	100,1	99,9	99,8	99,5	98,9	98,4	97,6	95,9	95,0	93,6	89,3	-	-	-	-	-	-	-	-	-	
GS 65-315	258	95,5	-	95,1	94,9	94,8	94,6	94,4	94,1	93,7	93,2	92,1	91,1	90,7	88,5	86,2	78,0	-	-	-	-	-	-	-	-	
GS 65-315	282	114,6	-	114,5	114,3	114,1	113,9	113,7	113,5	112,9	112,4	111,5	110,6	110,0	108,7	105,4	98,8	91,5	-	-	-	-	-	-	-	
GS 65-315	303	130,3	-	130,2	130,1	129,9	129,8	129,6	129,5	129,1	128,6	127,4	126,8	126,0	124,8	122,5	116,7	108,3	99,7	-	-	-	-	-	-	
GS 65-315	320	146,1	-	145,4	145,3	145,2	144,8	144,5	144,3	144,0	143,8	142,6	141,7	141,2	140,4	137,5	132,7	124,8	122,6	-	-	-	-	-	-	
GS 80-160	137	20,8	-	-	20,1	19,9	19,8	19,5	19,3	19,1	18,8	18,2	17,8	17,3	16,7	15,8	13,9	-	-	-	-	-	-	-	-	
GS 80-160	150	26,9	-	-	26,3	26,1	25,9	25,8	25,5	25,2	24,9	24,3	24,0	23,8	22,6	21,9	19,8	-	-	-	-	-	-	-	-	
GS 80-160	164	33,2	-	-	32,7	32,6	32,4	32,4	32,3	32,2	32,1	31,9	31,3	31,0	30,5	29,7	27,8	25,2	-	-	-	-	-	-	-	
GS 80-160	177	39,6	-	-	39,3	39,1	39,0	38,9	38,7	38,6	38,4	38,3	38,0	37,9	37,7	37,5	35,3	33,5	29,9	-	-	-	-	-	-	
GS 80-200	165	34,3	-	-	-	33,4	33,2	33,1	33,1	32,9	32,7	31,5	30,8	30,5	30,0	29,6	26,9	-	-	-	-	-	-	-	-	
GS 80-200	185	44,8	-	-	-	44,5	44,4	44,4	44,2	44,0	43,9	43,4	43,0	42,8	42,5	41,8	39,9	36,7	-	-	-	-	-	-	-	
GS 80-200	200	53,3	-	-	-	53,3	53,2	53,2	53,2	53,2	53,1	53,0	52,8	52,6	52,3	52,1	50,2	47,7	44,4	-	-	-	-	-	-	
GS 80-200	205	55,8	-	-	-	55,8	55,8	55,7	55,7	55,7	55,7	55,6	55,5	55,5	55,4	55,2	54,5	53,2	51,0	-	-	-	-	-	-	
GS 80-200	222	66,2	-	-	-	66,2	66,2	66,1	66,1	65,9	65,8	65,6	65,6	65,2	65,0	64,1	62,4	59,9	56,7	-	-	-	-	-	-	
GS 80-250	220	64,7	-	-	-	64,0	64,0	63,9	63,9	63,7	63,4	63,0	62,8	62,3	61,7	59,6	56,8	53,4	48,2	-	-	-	-	-	-	
GS 80-250	238	75,7	-	-	-	75,4	75,3	75,3	75,2	75,2	75,1	74,8	74,7	74,4	74,0	72,1	69,9	65,2	60,3	-	-	-	-	-	-	
GS 80-250	255	88,1	-	-	-	88,0	88,0	88,0	87,9	87,9	87,8	87,3	87,2	86,9	86,6	85,5	83,2	80,1	76,3	71,8	-	-	-	-	-	
GS 80-250	270	98,3	-	-	-	98,2	98,2	98,1	98,1	98,1	97,9	97,8	97,6	97,0	95,7	93,5	90,0	84,3	81,2	75,8	-	-	-	-	-	
GS 80-315L	265	95,8	-	-	-	-	95,8	95,8	95,8	95,7	95,7	95,5	95,4	95,2	94,3	93,2	90,5	87,6	83,5	-	-	-	-	-	-	
GS 80-315L	280	107,0	-	-	-	-	106,9	106,9	106,9	106,9	106,8	106,8	106,6	106,5	106,2	105,4	103,5	100,7	97,5	92,6	-	-	-	-	-	
GS 80-315L	300	123,4	-	-	-	-	123,4	123,4	123,4	123,4	123,3	123,3	123,3	123,3	123,3	123,0	122,7	120,5	117,8	114,5	108,0	-	-	-	-	
GS 80-315L	316	137,1	-	-	-	-	136,9	136,9	136,9	136,8	136,6	136,5	136,4	136,2	135,9	135,6	133,2	131,3	127,8	120,7	-	-	-	-	-	
GS 80-315L	334	152,8	-	-	-	-	151,9	151,9	151,9	151,8	151,6	151,3	150,9	150,5	149,7	148,5	147,2	143,1	138,3	132,6	-	-	-	-	-	
GS 100-160	149	28,0	-	-	-	-	26,3	25,9	25,5	25,1	24,2	23,7	23,4	22,3	20,6	19,1	16,8	-	-	-	-	-	-	-	-	
GS 100-160	156	30,9	-	-	-	-	29,2	28,8	28,5	28,2	27,7	26,7	25,9	24,9	24,1	22,9	20,4	18,1	-	-	-	-	-	-	-	
GS 100-160	170	37,8	-	-	-	-	36,8	36,6	36,3	36,1	35,7	35,1	34,6	34,1	33,2	31,0	28,6	25,9	22,8	-	-	-	-	-	-	
GS 100-160	183	44,9	-	-	-	-	43,6	43,3	43,0	42,7	42,1	41,7	41,5	40,9	40,1	38,5	36,9	34,5	31,7	27,9	-	-	-	-	-	
GS 100-200	171	34,5	-	-	-	-	31,4	30,9	30,7	30,4	30,1	29,6	29,1	28,7	27,7	26,4	24,9	22,5	20,8	-	-	-	-	-	-	
GS 100-200	187	42,7	-	-	-	-	40,7	40,5	40,2	40,0	39,9	39,7	39,6	39,6	38,8	37,5	36,4	34,7	32,7	30,3	-	-	-	-	-	
GS 100-200	204	51,7	-	-	-	-	51,4	51,2	51,1	50,9	50,7	50,5	50,4	50,2	49,9	49,2	47,9	46,3	44,6	41,7	-	-	-	-	-	
GS 100-200	220	61,6	-	-	-	-	-	61,6	61,6	61,6	61,5	61,5	61,4	61,2	61,0	60,8	60,4	59,9	58,3	56,6	55,0	51,9	49,8	-	-	
GS 100-250	210	59,8	-	-	-	-	59,7	59,6	59,5	59,0	58,5	57,9	57,5	56,8	56,0	54,7	52,0	49,0	45,8	42,7	-	-	-	-	-	
GS 100-250	230	72,4	-	-	-	-	72,0	71,9	71,8	71,6	71,2	70,7	70,4	70,0	68,5	66,7	64,2	61,0	57,9	53,8	-	-	-	-	-	
GS 100-250	250	86,1	-	-	-	-	-	84,4	84,3	84,2	84,1	84,0	83,8	83,6	82,7	80,8	78,9	76,0	72,8	70,5	65,1	-	-	-	-	
GS 100-250	265	99,6	-	-	-	-	-	-	98,7	98,5	98,2	97,9	97,5	97,2	96,4	95,3	93,8	92,0	90,8	87,9	83,5	77,9	-	-	-	
GS 100-315L	242	80,7	-	-	-	-	-	-	-	79,6	79,5	79,2	78,9	78,6	78,2	77,4	74,8	72,8	69,5	65,2	-	-	-	-	-	
GS 100-315L	265	97,9	-	-	-	-	-	-	-	-	96,8	96,6	96,4	96,2	96,0	94,7	93,7	91,4	89,1	86,2	75,7	-	-	-	-	
GS 100-315L	289	113,7	-	-	-	-	-	-	-	-	-	113,7	113,6	113,5	113,3	112,8	112,3	111,6	110,8	109,5	104,9	99,6	90,7	-	-	
GS 100-315L	312	139,3	-	-	-	-	-	-	-	-	-	-	139,3	139,1	139,1	138,3	137,1	135,8	133,7	130,6	128,1	123,2	117,9	112,0	-	

### PERFORMANCE TABLE 2900min<sup>-1</sup>

Model	Diameter	Q = Flow rate																						
		m <sup>3</sup> /h 0	180	240	270	300	330	360	390	420	450	480	510	540	570	600	660	720	780	840	900	960	1020	
		l/min 0	3000	4000	4500	5000	5500	6000	6500	7000	7500	8000	8500	9000	9500	10000	11000	12000	13000	14000	15000	16000	17000	
		H = Head [m]																						
GS 125-200	174	37,7	36,9	35,0	34,7	32,6	31,3	29,9	28,3	26,9	24,7	-	-	-	-	-	-	-	-	-	-	-	-	-
GS 125-200	190	45,1	45,1	44,8	43,9	43,0	42,1	40,7	39,2	37,6	36,3	33,5	31,3	-	-	-	-	-	-	-	-	-	-	-
GS 125-200	207	54,0	54,0	53,7	53,4	52,9	52,2	51,8	50,4	48,9	47,3	45,2	43,4	40,7	38,5	-	-	-	-	-	-	-	-	-
GS 125-200	224	62,8	62,8	62,5	62,2	61,8	60,9	60,0	58,9	57,7	56,3	54,8	51,9	50,2	47,5	44,7	-	-	-	-	-	-	-	-
GS 125-250L	213	56,4	56,0	55,6	55,2	54,7	54,0	52,8	51,7	50,6	48,5	46,9	44,0	-	-	-	-	-	-	-	-	-	-	-
GS 125-250L	233	68,4	68,0	67,8	67,5	67,1	66,4	65,7	64,8	63,6	62,0	60,2	58,1	55,8	-	-	-	-	-	-	-	-	-	-
GS 125-250L	254	82,4	82,0	82,0	81,8	81,3	80,7	80,1	79,5	78,5	76,9	75,7	73,4	71,8	69,0	66,4	-	-	-	-	-	-	-	-
GS 125-250L	274	98,0	97,0	96,5	96,2	96,0	95,8	95,6	94,8	94,2	93,4	92,0	90,5	88,3	86,0	83,5	75,4	-	-	-	-	-	-	-
GS 125-315	259	86,7	85,9	83,5	81,9	80,4	77,8	75,7	72,9	70,2	66,5	62,1	59,5	-	-	-	-	-	-	-	-	-	-	-
GS 125-315	284	105,4	105,4	103,9	102,5	101,5	99,9	98,7	96,5	93,9	91,0	87,5	84,4	80,5	-	-	-	-	-	-	-	-	-	-
GS 125-315	309	126,6	125,3	124,6	123,1	122,5	121,7	120,6	117,9	116,4	113,6	111,6	108,2	105,6	101,7	97,6	-	-	-	-	-	-	-	-
GS 150-200	164	31,1	30,6	28,8	27,8	27,2	26,3	24,9	23,5	22,3	21,0	-	-	-	-	-	-	-	-	-	-	-	-	-
GS 150-200	180	37,6	36,6	35,3	34,6	33,7	32,8	31,9	31,0	29,9	28,8	27,6	26,5	-	-	-	-	-	-	-	-	-	-	-
GS 150-200	195	45,2	44,9	43,7	43,1	42,4	41,8	40,8	39,7	38,6	37,5	36,3	34,9	33,5	31,4	-	-	-	-	-	-	-	-	-
GS 150-200	211	55,1	54,7	53,6	53,0	52,4	51,7	51,2	50,5	50,1	49,7	48,9	48,4	47,4	46,7	44,8	40,8	-	-	-	-	-	-	-
GS 150-250	213	59,8	-	58,0	57,3	56,9	56,4	55,6	54,8	54,3	53,9	52,7	52,0	50,9	50,1	49,3	47,0	44,9	42,2	39,9	37,2	-	-	-
GS 150-250	233	71,7	-	71,7	71,2	70,7	70,1	69,6	69,2	68,5	67,7	67,0	66,1	65,5	64,6	63,6	61,7	59,3	57,3	54,9	52,0	49,6	-	-
GS 150-250	250	81,9	-	81,9	81,7	81,4	81,1	80,8	80,5	80,2	79,7	79,3	78,7	78,2	77,3	76,4	74,9	72,5	70,3	68,0	65,3	61,9	58,6	-

PERFORMANCE RANGE  
1450min<sup>-1</sup>

SELECTION CHART

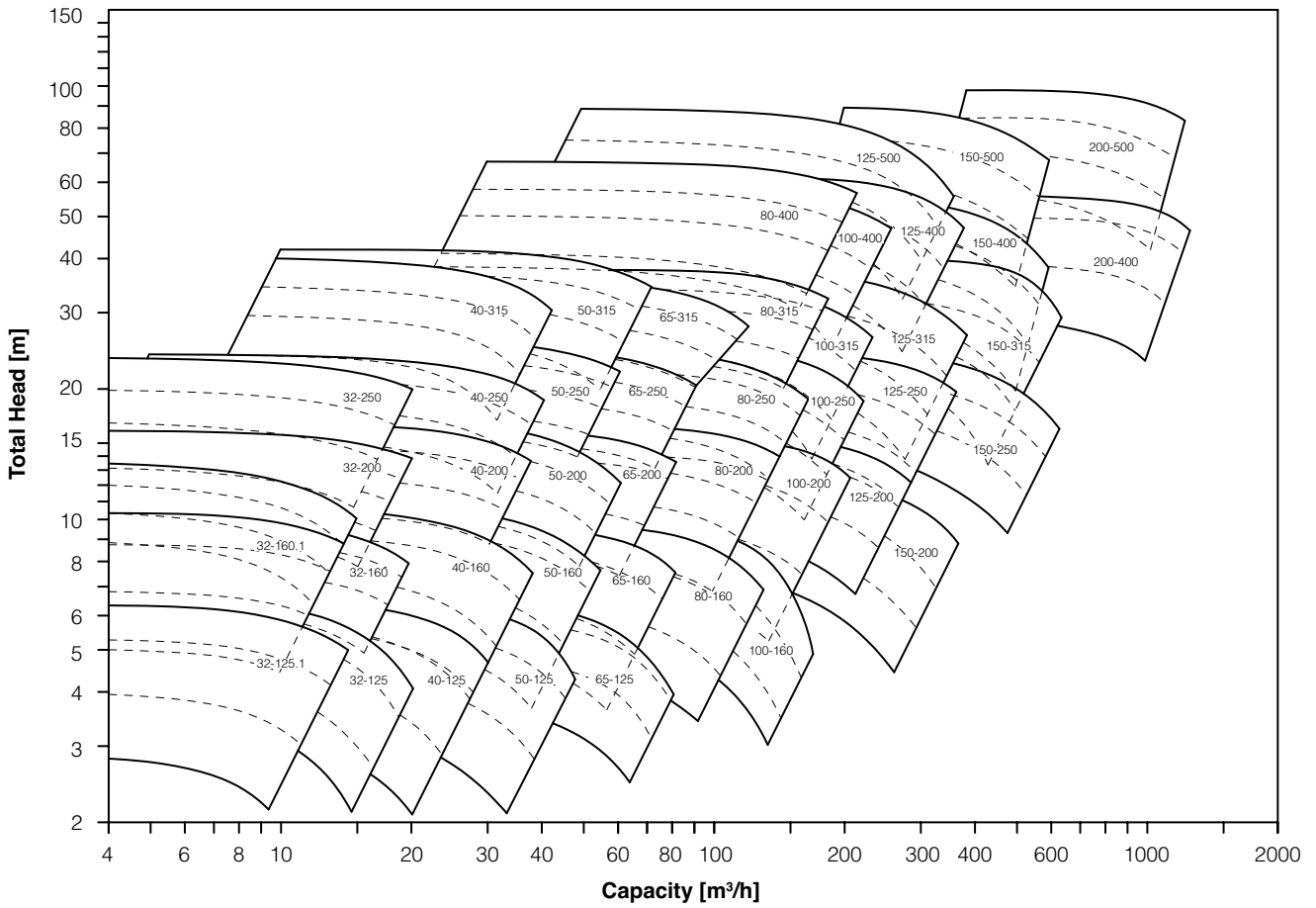

### PERFORMANCE TABLE 1450min<sup>-1</sup>

Model	Diameter	Q = Flow rate											
		m <sup>3</sup> /h 0	3	6	9	12	15	18	21	24	27	30	36
		l/min 0	50	100	150	200	250	300	350	400	450	500	600
H = Head [m]													
GS 32-125.1	100	2,9	2,8	2,7	2,2	-	-	-	-	-	-	-	-
GS 32-125.1	115	4,0	4,0	3,8	3,5	-	-	-	-	-	-	-	-
GS 32-125.1	129	5,3	5,3	5,2	4,9	4,4	-	-	-	-	-	-	-
GS 32-125.1	140	6,3	6,3	6,2	5,9	5,5	-	-	-	-	-	-	-
GS 32-160.1	126	5,1	5,0	4,9	4,6	-	-	-	-	-	-	-	-
GS 32-160.1	145	6,8	6,8	6,7	6,5	5,9	-	-	-	-	-	-	-
GS 32-160.1	163	8,8	8,8	8,7	8,5	7,9	7,0	-	-	-	-	-	-
GS 32-160.1	177	10,4	10,4	10,3	10,0	9,4	8,5	-	-	-	-	-	-
GS 32-200.1	172	9,1	8,9	8,6	7,8	6,4	4,1	-	-	-	-	-	-
GS 32-200.1	184	10,6	10,4	10,1	9,2	8,0	6,2	-	-	-	-	-	-
GS 32-200.1	196	12,1	12,0	11,7	10,9	9,8	8,1	-	-	-	-	-	-
GS 32-200.1	207	13,6	13,6	13,2	12,5	11,5	10,0	7,9	-	-	-	-	-
GS 32-125	106	3,8	3,7	3,5	3,3	2,7	-	-	-	-	-	-	-
GS 32-125	119	4,5	4,5	4,4	4,1	3,7	3,0	-	-	-	-	-	-
GS 32-125	131	5,6	5,6	5,4	5,2	5,0	4,6	3,7	-	-	-	-	-
GS 32-125	142	6,5	6,5	6,5	6,3	6,1	5,5	4,8	-	-	-	-	-
GS 32-160	139	6,2	-	6,1	6,0	5,6	5,1	-	-	-	-	-	-
GS 32-160	152	7,6	-	7,5	7,3	7,1	6,9	-	-	-	-	-	-
GS 32-160	164	9,0	-	8,9	8,7	8,6	8,2	7,6	-	-	-	-	-
GS 32-160	177	10,3	-	10,1	9,8	9,5	9,1	8,4	-	-	-	-	-
GS 32-200	170	9,4	-	9,3	9,1	8,6	7,8	-	-	-	-	-	-
GS 32-200	184	11,1	-	10,9	10,7	10,4	9,8	9,0	-	-	-	-	-
GS 32-200	197	12,7	-	12,7	12,5	12,1	11,6	10,9	10,2	-	-	-	-
GS 32-200	208	14,4	-	14,4	14,2	13,7	13,4	12,7	11,8	10,7	-	-	-
GS 32-200	219	15,9	-	15,8	15,7	15,3	14,8	14,4	13,6	12,5	-	-	-
GS 32-250	198	13,2	-	12,9	12,4	11,7	-	-	-	-	-	-	-
GS 32-250	222	16,7	-	16,5	15,9	15,2	14,3	13,1	-	-	-	-	-
GS 32-250	241	19,9	-	19,7	19,2	18,8	17,9	16,6	15,1	-	-	-	-
GS 32-250	262	23,5	-	23,4	23,1	22,5	21,8	20,9	19,6	-	-	-	-
GS 40-125	105	3,4	-	3,2	3,1	3,0	2,7	-	-	-	-	-	-
GS 40-125	119	4,5	-	4,4	4,3	4,1	3,9	3,6	3,3	-	-	-	-
GS 40-125	131	5,7	-	5,7	5,6	5,5	5,3	5,1	4,9	4,5	-	-	-
GS 40-125	142	6,7	-	6,6	6,5	6,4	6,3	6,2	5,9	5,6	5,2	-	-
GS 40-160	134	6,0	-	5,9	5,8	5,6	5,4	5,2	4,8	4,4	3,9	2,6	-
GS 40-160	150	7,6	-	7,6	7,5	7,4	7,2	7,0	6,7	6,3	5,9	5,4	-
GS 40-160	163	9,1	-	9,1	9,1	9,0	8,9	8,8	8,6	8,3	7,9	7,5	6,4
GS 40-160	177	10,7	-	10,7	10,6	10,5	10,4	10,2	10,0	9,7	9,4	8,9	8,0
GS 40-200	172	10,3	-	10,3	10,3	10,2	10,2	10,0	9,8	9,6	9,1	8,8	-
GS 40-200	189	12,5	-	12,5	12,5	12,4	12,3	12,1	11,9	11,6	11,3	10,9	-
GS 40-200	205	14,8	-	14,8	14,8	14,7	14,6	14,4	14,3	14,0	13,7	13,3	12,3
GS 40-200	219	16,7	-	16,7	16,7	16,6	16,4	16,3	16,1	15,8	15,3	14,9	12,4
GS 40-250	211	15,6	-	15,5	15,3	15,1	14,9	14,6	14,1	13,5	12,9	12,1	-
GS 40-250	228	18,4	-	18,3	18,1	18,0	17,7	17,4	17,0	16,6	16,1	15,3	-
GS 40-250	245	21,4	-	21,4	21,2	20,9	20,7	20,5	20,1	19,8	19,3	18,7	17,1
GS 40-250	260	24,0	-	24,0	23,9	23,7	23,5	23,2	23,0	22,6	22,1	21,7	20,3
GS 40-315	273	24,5	-	24,3	24,1	23,8	23,5	23,0	22,3	21,2	19,8	18,1	-
GS 40-315	300	30,1	-	29,9	29,5	29,3	28,8	28,5	27,9	27,1	26,2	25,0	-
GS 40-315	322	35,0	-	34,6	34,3	34,1	33,8	33,4	32,8	32,1	31,5	30,5	27,9
GS 40-315	344	40,5	-	40,3	40,1	39,9	39,7	39,3	38,6	38,0	37,2	36,3	34,0

**PERFORMANCE TABLE**  
**1450min<sup>-1</sup>**

Model	Diameter	Q = Flow rate																	
		m <sup>3</sup> /h 0	12	18	24	30	36	42	48	54	60	66	72	78	84	90	102	114	126
		l/min 0	200	300	400	500	600	700	800	900	1000	1100	1200	1300	1400	1500	1700	1900	2100
		H = Head [m]																	
GS 50-125	111	3,7	3,4	3,2	2,9	2,3	-	-	-	-	-	-	-	-	-	-	-	-	-
GS 50-125	123	4,6	4,5	4,3	4,0	3,5	3,1	-	-	-	-	-	-	-	-	-	-	-	-
GS 50-125	134	5,7	5,6	5,5	5,3	5,1	4,7	4,3	-	-	-	-	-	-	-	-	-	-	-
GS 50-125	144	6,7	6,5	6,4	6,2	6,1	5,7	5,2	-	-	-	-	-	-	-	-	-	-	-
GS 50-160	131	5,5	5,4	5,2	4,8	4,5	3,9	-	-	-	-	-	-	-	-	-	-	-	-
GS 50-160	148	7,4	7,4	7,1	6,8	6,5	6,1	5,2	-	-	-	-	-	-	-	-	-	-	-
GS 50-160	164	9,4	9,4	9,3	9,0	8,7	8,4	7,9	-	-	-	-	-	-	-	-	-	-	-
GS 50-160	177	11,0	10,9	10,7	10,5	10,2	9,7	9,1	8,3	-	-	-	-	-	-	-	-	-	-
GS 50-200	171	10,2	10,2	10,1	9,9	9,7	9,1	8,6	8,0	7,1	-	-	-	-	-	-	-	-	-
GS 50-200	188	12,3	12,2	12,2	12,1	12,0	11,5	10,9	9,8	9,1	-	-	-	-	-	-	-	-	-
GS 50-200	203	14,5	14,5	14,5	14,4	14,2	13,7	13,2	12,4	11,5	10,4	-	-	-	-	-	-	-	-
GS 50-200	219	16,8	16,8	16,8	16,7	16,4	15,9	15,2	14,5	13,5	12,3	-	-	-	-	-	-	-	-
GS 50-250	210	16,2	16,1	15,9	15,7	15,4	15,1	14,6	14,0	-	-	-	-	-	-	-	-	-	-
GS 50-250	221	18,0	17,9	17,7	17,5	17,2	16,9	16,4	16,0	-	-	-	-	-	-	-	-	-	-
GS 50-250	238	20,7	20,7	20,6	20,5	20,2	19,9	19,6	18,9	18,2	-	-	-	-	-	-	-	-	-
GS 50-250	254	23,5	23,4	23,3	23,2	23,0	22,7	22,2	21,6	20,9	-	-	-	-	-	-	-	-	-
GS 50-250	270	26,4	26,3	26,1	25,9	25,6	25,2	24,7	24,0	23,1	22,1	-	-	-	-	-	-	-	-
GS 50-315	277	26,6	26,4	26,2	25,7	25,3	24,6	23,5	21,9	20,2	-	-	-	-	-	-	-	-	-
GS 50-315	302	32,2	32,0	31,9	31,5	30,9	30,4	29,7	28,6	20,0	-	-	-	-	-	-	-	-	-
GS 50-315	324	37,2	37,2	37,0	36,7	36,4	35,9	35,3	34,4	33,5	32,1	-	-	-	-	-	-	-	-
GS 50-315	344	42,0	42,0	42,0	41,8	41,5	40,9	40,3	39,7	38,4	37,2	35,9	-	-	-	-	-	-	-
GS 65-125	120	4,2	-	3,9	3,8	3,7	3,5	3,3	3,1	2,9	2,7	-	-	-	-	-	-	-	-
GS 65-125	130	5,0	-	4,9	4,8	4,8	4,7	4,5	4,4	4,2	4,0	3,6	-	-	-	-	-	-	-
GS 65-125	139	5,8	-	5,8	5,8	5,8	5,7	5,6	5,5	5,3	5,0	4,7	4,4	-	-	-	-	-	-
GS 65-125	147	6,6	-	6,6	6,5	6,4	6,3	6,2	6,0	5,7	5,5	5,1	4,7	-	-	-	-	-	-
GS 65-160	135	5,6	-	5,2	5,1	4,9	4,7	4,4	4,1	3,8	-	-	-	-	-	-	-	-	-
GS 65-160	150	6,9	-	6,7	6,6	6,5	6,3	6,1	5,9	5,6	5,3	-	-	-	-	-	-	-	-
GS 65-160	165	8,6	-	8,4	8,4	8,4	8,3	8,2	8,1	7,8	7,6	7,3	6,8	-	-	-	-	-	-
GS 65-160	177	10,0	-	9,8	9,8	9,7	9,6	9,5	9,4	9,2	9,0	8,7	8,3	-	-	-	-	-	-
GS 65-200	162	8,5	-	8,5	8,5	8,4	8,3	8,2	8,0	7,7	-	-	-	-	-	-	-	-	-
GS 65-200	183	11,0	-	11,0	11,0	10,8	10,8	10,6	10,4	10,2	10,1	-	-	-	-	-	-	-	-
GS 65-200	203	13,7	-	13,7	13,7	13,7	13,6	13,6	13,5	13,3	13,1	12,8	-	-	-	-	-	-	-
GS 65-200	219	16,0	-	16,0	16,0	16,0	16,0	15,9	15,7	15,5	15,2	14,8	14,2	13,1	-	-	-	-	-
GS 65-250	215	15,3	-	15,2	15,1	15,0	14,9	14,8	14,6	14,3	14,0	13,6	13,1	12,7	12,0	-	-	-	-
GS 65-250	237	18,7	-	18,7	18,7	18,6	18,6	18,5	18,3	18,0	17,7	17,3	16,8	16,4	15,5	-	-	-	-
GS 65-250	254	21,7	-	21,7	21,7	21,6	21,6	21,4	21,2	21,0	20,7	20,2	19,7	19,1	18,5	17,8	-	-	-
GS 65-250	273	25,1	-	25,1	25,0	24,9	24,7	24,5	24,3	24,0	23,6	23,2	22,6	22,1	21,3	20,5	-	-	-
GS 65-315	261	25,2	-	-	24,6	24,5	24,4	24,2	24,0	23,7	23,3	22,9	22,3	21,8	20,9	20,2	18,8	-	-
GS 65-315	282	28,7	-	-	28,7	28,6	28,4	28,2	28,0	27,8	27,6	27,1	26,7	26,2	25,5	24,7	23,3	-	-
GS 65-315	303	32,7	-	-	32,7	32,6	32,5	32,3	32,1	31,8	31,5	31,1	30,7	30,2	29,7	29,0	27,8	25,9	-
GS 65-315	320	36,1	-	-	36,1	35,9	35,8	35,6	35,4	35,1	34,8	34,4	34,1	33,5	33,0	32,4	31,6	29,0	26,7

### PERFORMANCE TABLE 1450min<sup>-1</sup>

Model	Diameter	Q = Flow rate															
		m <sup>3</sup> /h 0	30	48	60	78	90	108	120	132	150	168	180	198	210	240	270
		l/min 0	500	800	1000	1300	1500	1800	2000	2200	2500	2800	3000	3300	3500	4000	4500
		H = Head [m]															
GS 80-160	137	5,3	5,1	4,9	4,6	4,3	4,0	3,6	-	-	-	-	-	-	-	-	-
GS 80-160	150	6,8	6,7	6,4	6,2	5,8	5,5	5,0	4,5	-	-	-	-	-	-	-	-
GS 80-160	164	8,4	8,2	8,1	8,0	7,8	7,6	7,2	6,8	6,3	-	-	-	-	-	-	-
GS 80-160	177	10,0	9,8	9,7	9,6	9,5	9,1	8,9	8,5	7,8	7,2	-	-	-	-	-	-
GS 80-200	165	8,5	8,4	8,2	8,0	7,8	7,5	7,1	6,7	-	-	-	-	-	-	-	-
GS 80-200	185	11,2	11,0	11,0	11,0	10,8	10,6	10,2	9,9	9,3	-	-	-	-	-	-	-
GS 80-200	200	13,4	13,4	13,3	13,1	13,0	12,9	12,5	12,1	11,4	-	-	-	-	-	-	-
GS 80-200	205	14,1	14,0	14,0	14,0	13,9	13,9	13,7	13,5	13,0	12,7	-	-	-	-	-	-
GS 80-200	222	16,4	16,4	16,4	16,4	16,3	16,2	16,0	15,8	15,3	14,9	-	-	-	-	-	-
GS 80-250	220	16,1	16,1	15,9	15,7	15,4	15,0	14,2	13,4	12,7	-	-	-	-	-	-	-
GS 80-250	238	19,1	19,0	18,9	18,7	18,4	18,1	17,4	16,9	16,3	14,7	-	-	-	-	-	-
GS 80-250	255	22,1	22,0	22,0	21,9	21,6	21,3	20,7	20,1	19,6	18,1	-	-	-	-	-	-
GS 80-250	270	24,7	24,7	24,7	24,6	24,3	23,9	23,2	22,5	21,7	20,3	18,7	-	-	-	-	-
GS 80-315	262	23,4	-	23,3	23,3	23,0	22,8	22,7	22,3	22,0	21,6	20,4	-	-	-	-	-
GS 80-315	280	26,7	-	26,6	26,6	26,4	26,4	26,2	26,0	25,7	25,4	24,7	24,0	-	-	-	-
GS 80-315	300	30,7	-	30,7	30,7	30,7	30,7	30,4	30,2	30,0	29,7	29,2	28,7	-	-	-	-
GS 80-315	316	34,1	-	34,1	34,1	34,0	34,0	33,8	33,6	33,3	32,9	32,2	32,0	30,5	-	-	-
GS 80-315	334	37,9	-	37,8	37,8	37,7	37,7	37,4	37,1	36,9	36,3	35,7	35,0	33,9	-	-	-
GS 80-400	335	38,4	-	37,9	37,3	36,6	36,0	34,7	33,9	32,9	31,3	28,8	-	-	-	-	-
GS 80-400	347	41,2	-	40,7	40,3	39,5	38,7	37,9	37,1	36,0	34,5	32,4	-	-	-	-	-
GS 80-400	382	50,3	-	50,0	49,4	48,6	48,2	47,8	47,5	46,4	44,7	43,6	42,0	-	-	-	-
GS 80-400	409	57,8	-	57,6	57,3	56,6	56,2	55,8	55,0	54,2	53,5	51,9	50,3	48,3	47,5	-	-
GS 80-400	438	67,3	-	66,9	66,6	66,4	65,9	65,5	64,9	64,0	63,2	61,7	60,3	58,4	57,6	-	-
GS 100-160	149	6,9	6,5	6,0	5,7	5,1	4,7	4,1	3,6	3,2	-	-	-	-	-	-	-
GS 100-160	156	7,8	7,5	7,1	6,7	6,2	5,7	5,1	4,6	3,8	-	-	-	-	-	-	-
GS 100-160	170	9,6	9,4	9,1	8,8	8,3	7,9	7,2	6,6	6,0	4,9	-	-	-	-	-	-
GS 100-160	183	10,9	10,7	10,4	10,3	9,8	9,5	9,3	8,7	8,1	6,9	-	-	-	-	-	-
GS 100-200	171	8,8	-	7,6	7,3	6,9	6,5	6,1	5,6	5,3	-	-	-	-	-	-	-
GS 100-200	187	10,9	-	10,1	9,9	9,7	9,5	9,1	8,8	8,4	7,9	-	-	-	-	-	-
GS 100-200	204	13,1	-	12,9	12,8	12,7	12,6	12,4	12,2	11,9	11,4	10,9	10,1	-	-	-	-
GS 100-200	220	15,5	-	15,5	15,5	15,3	15,3	15,1	14,9	14,7	14,5	14,2	13,7	12,9	-	-	-
GS 100-250	210	14,9	-	14,6	14,4	14,0	13,6	13,0	12,3	11,8	10,8	9,6	8,7	-	-	-	-
GS 100-250	230	18,1	-	18,0	17,8	17,6	17,3	16,7	16,2	15,7	14,8	13,6	12,7	11,5	-	-	-
GS 100-250	250	21,6	-	21,4	21,2	21,0	20,7	20,3	20,0	19,4	18,5	17,4	16,6	15,3	14,5	-	-
GS 100-250	270	25,8	-	25,7	25,5	25,3	25,1	24,9	24,5	24,1	23,5	22,7	22,0	20,7	19,8	-	-
GS 100-315	242	20,5	-	20,5	20,3	20,1	19,9	19,5	19,2	17,9	16,1	-	-	-	-	-	-
GS 100-315	265	24,8	-	24,7	24,5	24,2	24,0	23,4	22,9	21,9	21,2	18,6	-	-	-	-	-
GS 100-315	289	30,0	-	30,0	30,0	29,9	29,7	29,4	28,9	28,2	27,4	26,0	25,1	23,4	-	-	-
GS 100-315	312	34,9	-	34,9	34,9	34,8	34,6	34,3	34,0	33,7	32,9	31,8	31,0	29,8	28,3	-	-
GS 100-400	320	34,5	-	34,3	34,2	33,7	33,4	33,2	32,7	32,3	30,7	29,1	26,1	-	-	-	-
GS 100-400	350	40,8	-	40,8	40,8	40,7	40,7	40,3	39,9	39,2	38,5	37,2	36,0	34,2	32,9	-	-
GS 100-400	381	48,7	-	48,6	48,5	48,5	48,1	47,6	47,3	46,7	45,8	44,2	43,5	41,3	40,3	36,8	-
GS 100-400	412	57,8	-	-	57,6	57,5	57,5	57,3	57,0	56,5	55,9	55,0	54,3	53,1	51,9	48,8	45,5

### PERFORMANCE TABLE

1450min<sup>-1</sup>

Model	Diameter	Q = Flow rate																		
		m <sup>3</sup> /h 0	90	120	150	180	210	240	270	300	330	360	390	420	450	480	510	540	570	600
		l/min 0	1500	2000	2500	3000	3500	4000	4500	5000	5500	6000	6500	7000	7500	8000	8500	9000	9500	10000
		H = Head [m]																		
GS 125-200	174	9,4	9,4	9,1	8,4	7,6	6,8	5,7	-	-	-	-	-	-	-	-	-	-	-	-
GS 125-200	190	11,2	11,2	11,0	10,8	10,3	9,6	8,3	-	-	-	-	-	-	-	-	-	-	-	-
GS 125-200	207	13,6	13,6	13,5	13,4	12,9	12,4	11,5	10,5	-	-	-	-	-	-	-	-	-	-	-
GS 125-200	224	15,7	15,6	15,5	15,3	14,9	14,3	13,6	12,7	11,5	-	-	-	-	-	-	-	-	-	-
GS 125-250	213	14,6	14,6	14,4	14,1	13,7	12,9	12,0	10,8	-	-	-	-	-	-	-	-	-	-	-
GS 125-250	233	17,3	17,1	17,0	16,8	16,4	15,8	14,9	13,8	-	-	-	-	-	-	-	-	-	-	-
GS 125-250	254	20,9	20,9	20,7	20,4	20,1	19,6	18,8	17,9	16,7	15,4	-	-	-	-	-	-	-	-	-
GS 125-250	274	24,4	24,4	24,3	24,2	24,0	23,8	23,2	22,7	21,9	21,0	19,8	-	-	-	-	-	-	-	-
GS 125-315	259	21,7	21,7	21,2	20,3	19,2	17,7	16,0	14,4	10,9	9,2	-	-	-	-	-	-	-	-	-
GS 125-315	284	26,4	26,4	26,0	25,5	24,7	23,6	22,1	20,2	18,1	16,0	13,3	-	-	-	-	-	-	-	-
GS 125-315	309	31,8	31,7	31,3	30,9	30,1	29,3	28,0	26,5	24,6	22,8	20,2	-	-	-	-	-	-	-	-
GS 125-315	334	38,3	37,8	37,6	37,0	36,5	35,9	34,7	33,4	31,9	30,0	28,1	26,0	-	-	-	-	-	-	-
GS 125-400	329	37,1	36,6	36,0	34,8	33,3	31,2	28,3	-	-	-	-	-	-	-	-	-	-	-	-
GS 125-400	360	44,3	44,3	44,1	42,8	41,9	39,2	37,9	35,2	-	-	-	-	-	-	-	-	-	-	-
GS 125-400	392	53,2	52,8	52,6	52,0	51,3	50,2	48,6	46,3	42,9	39,0	-	-	-	-	-	-	-	-	-
GS 125-400	424	62,3	61,9	61,9	61,7	60,8	60,3	59,1	58,4	55,5	52,5	49,3	45,3	-	-	-	-	-	-	-
GS 125-500	396	51,7	50,6	49,2	47,8	45,5	42,0	37,8	32,5	-	-	-	-	-	-	-	-	-	-	-
GS 125-500	434	62,5	61,2	60,1	58,8	56,7	53,8	50,4	49,0	-	-	-	-	-	-	-	-	-	-	-
GS 125-500	473	75,0	73,3	72,1	70,7	68,3	65,4	62,7	58,0	52,9	-	-	-	-	-	-	-	-	-	-
GS 125-500	511	88,8	88,0	86,7	85,1	83,0	80,4	76,3	72,5	67,9	61,5	-	-	-	-	-	-	-	-	-
GS 150-200	164	7,8	7,6	7,2	6,4	6,1	5,6	4,9	4,1	-	-	-	-	-	-	-	-	-	-	-
GS 150-200	180	9,6	9,6	9,2	8,7	8,1	7,8	6,9	6,2	5,5	-	-	-	-	-	-	-	-	-	-
GS 150-200	195	11,8	11,5	11,2	10,9	10,4	9,8	9,3	8,6	7,7	6,8	-	-	-	-	-	-	-	-	-
GS 150-200	211	13,7	13,7	13,5	13,0	12,5	12,1	11,6	11,1	10,5	9,9	9,0	-	-	-	-	-	-	-	-
GS 150-250	213	15,6	-	15,5	15,1	14,9	14,4	14,1	13,4	12,9	12,3	11,8	11,0	10,4	9,9	-	-	-	-	-
GS 150-250	233	18,1	-	18,1	18,0	17,9	17,7	17,2	16,9	16,5	15,9	15,3	14,7	14,1	13,4	12,7	-	-	-	-
GS 150-250	254	21,5	-	21,5	21,4	21,2	21,0	20,9	20,6	20,2	20,0	19,3	18,7	18,1	17,5	16,9	16,0	15,2	-	-
GS 150-250	274	25,0	-	25,0	24,9	24,8	24,6	24,3	24,0	23,8	23,3	22,9	22,4	21,9	21,2	20,5	19,7	19,0	18,0	17,1
GS 150-315	273	23,5	-	23,0	22,6	22,1	21,6	21,1	20,3	19,8	18,7	17,7	18,0	14,0	-	-	-	-	-	-
GS 150-315	300	28,3	-	28,0	27,7	27,3	26,8	26,4	26,0	25,5	24,7	23,9	23,8	21,7	20,3	18,8	-	-	-	-
GS 150-315	326	34,4	-	33,9	33,7	33,5	33,0	32,3	32,1	31,8	31,1	30,3	29,9	29,0	28,1	27,0	25,7	24,1	-	-
GS 150-315	352	42,6	-	41,5	41,0	40,6	40,3	40,1	40,0	39,9	39,8	39,6	39,1	38,6	38,1	37,7	36,5	35,7	34,0	31,9
GS 150-400	319	32,8	-	32,4	31,9	31,4	30,8	30,1	29,5	28,5	27,6	26,4	25,2	23,8	22,4	21,0	19,1	17,3	-	-
GS 150-400	350	39,7	-	39,7	39,5	39,0	38,7	38,1	37,5	36,7	35,8	34,6	33,4	32,0	30,5	28,7	26,8	24,4	22,4	-
GS 150-400	380	47,7	-	-	47,7	47,7	47,1	46,5	45,9	45,0	43,7	42,7	41,5	40,2	38,3	36,4	34,8	33,0	30,9	-
GS 150-400	411	55,9	-	-	55,9	55,5	55,1	54,7	54,2	53,9	53,1	52,0	51,0	49,5	48,2	46,3	43,7	42,2	39,8	37,4
GS 150-500	396	52,7	-	-	52,0	51,4	50,6	49,0	48,1	46,7	45,2	43,7	41,5	39,9	38,8	37,8	36,0	-	-	-
GS 150-500	434	63,3	-	-	63,3	62,8	62,4	61,3	60,4	59,5	57,6	56,0	53,9	52,2	50,1	47,3	46,0	43,9	-	-
GS 150-500	473	76,4	-	-	76,4	76,1	75,8	75,2	74,5	73,1	71,8	70,2	69,0	66,7	64,4	62,0	59,7	57,4	54,8	-
GS 150-500	511	89,3	-	-	89,3	89,3	89,3	89,0	88,4	87,6	86,3	85,0	83,2	81,7	79,6	77,0	74,5	72,2	69,7	67,1

Model	Diameter	Q = Flow rate										
		m <sup>3</sup> /h 0	300	400	500	600	700	800	900	1000	1100	1200
		l/min 0	5000	6667	8333	10000	11667	13333	15000	16667	18333	20000
		H = Head [m]										
GS 200-400	326	32,5	31,3	30,0	29,2	28,0	27,1	26,5	25,3	23,6	-	-
GS 200-400	357	43,5	42,6	42,0	41,9	41,5	37,9	37,2	36,0	33,4	-	-
GS 200-400	389	49,5	-	49,5	49,5	49,5	49,1	48,6	47,4	45,9	44,3	-
GS 200-400	420	57,1	-	56,2	56,0	55,5	54,8	54,4	53,9	53,5	51,0	48,1
GS 200-500	411	56,4	-	56,2	55,2	54,0	51,9	49,2	46,4	42,5	-	-
GS 200-500	451	70,7	-	70,7	69,9	68,7	67,1	64,4	61,6	58,5	54,9	-
GS 200-500	490	84,4	-	-	84,4	84,0	82,7	80,3	77,4	74,0	70,4	-
GS 200-500	530	97,7	-	-	97,7	97,5	96,5	95,7	93,8	91,4	88,2	84,2



### PERFORMANCE CURVE GS 32-125.1

2 poles

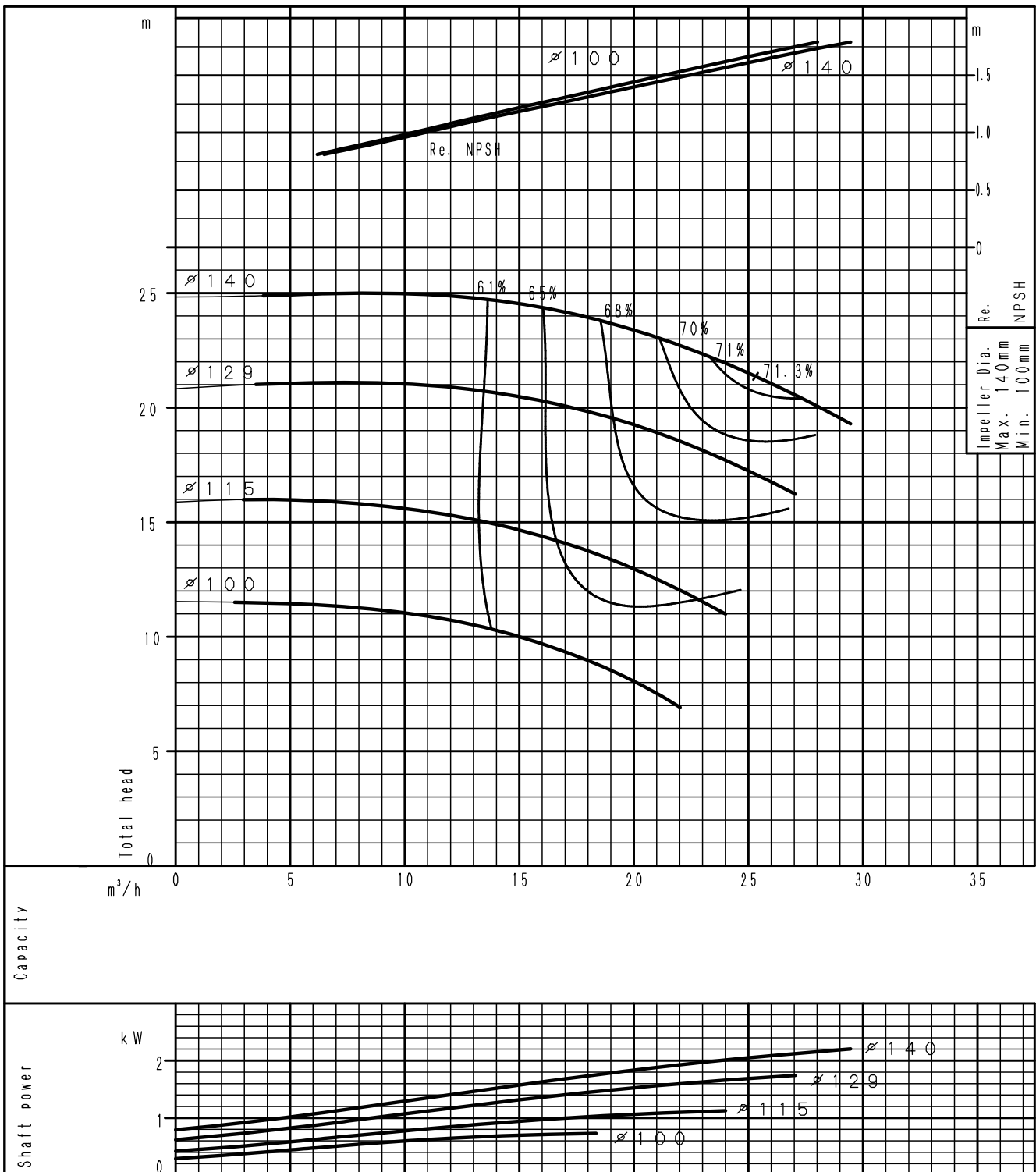

(speed 2900<sup>-1</sup>) According to ISO 9906 grade 3B

PERFORMANCE CURVES

PERFORMANCE CURVE  
GS 32-160.1

2 poles

PERFORMANCE CURVES

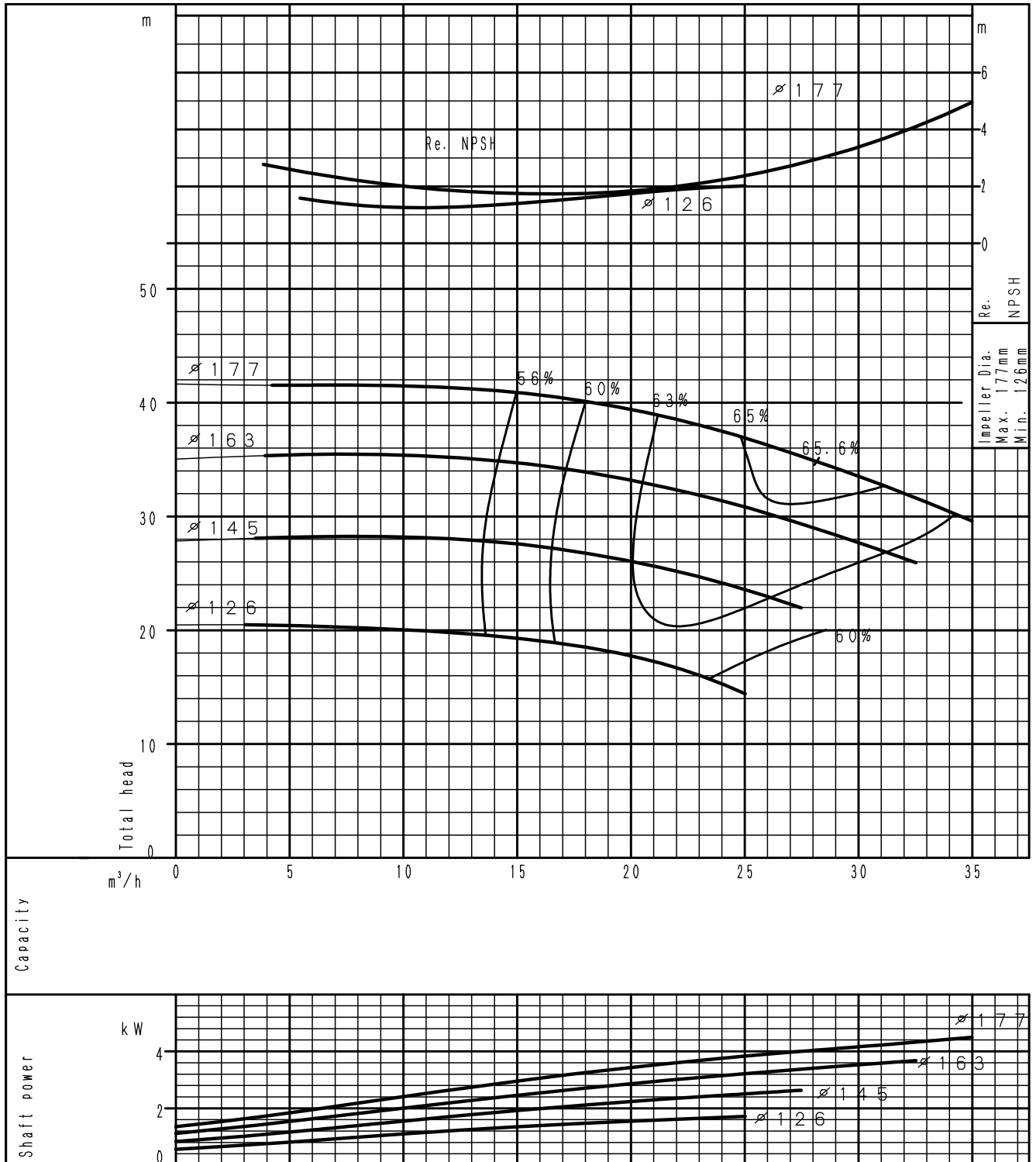

(speed 2900<sup>-1</sup>) According to ISO 9906 grade 3B

### PERFORMANCE CURVE GS 32-200.1

2 poles

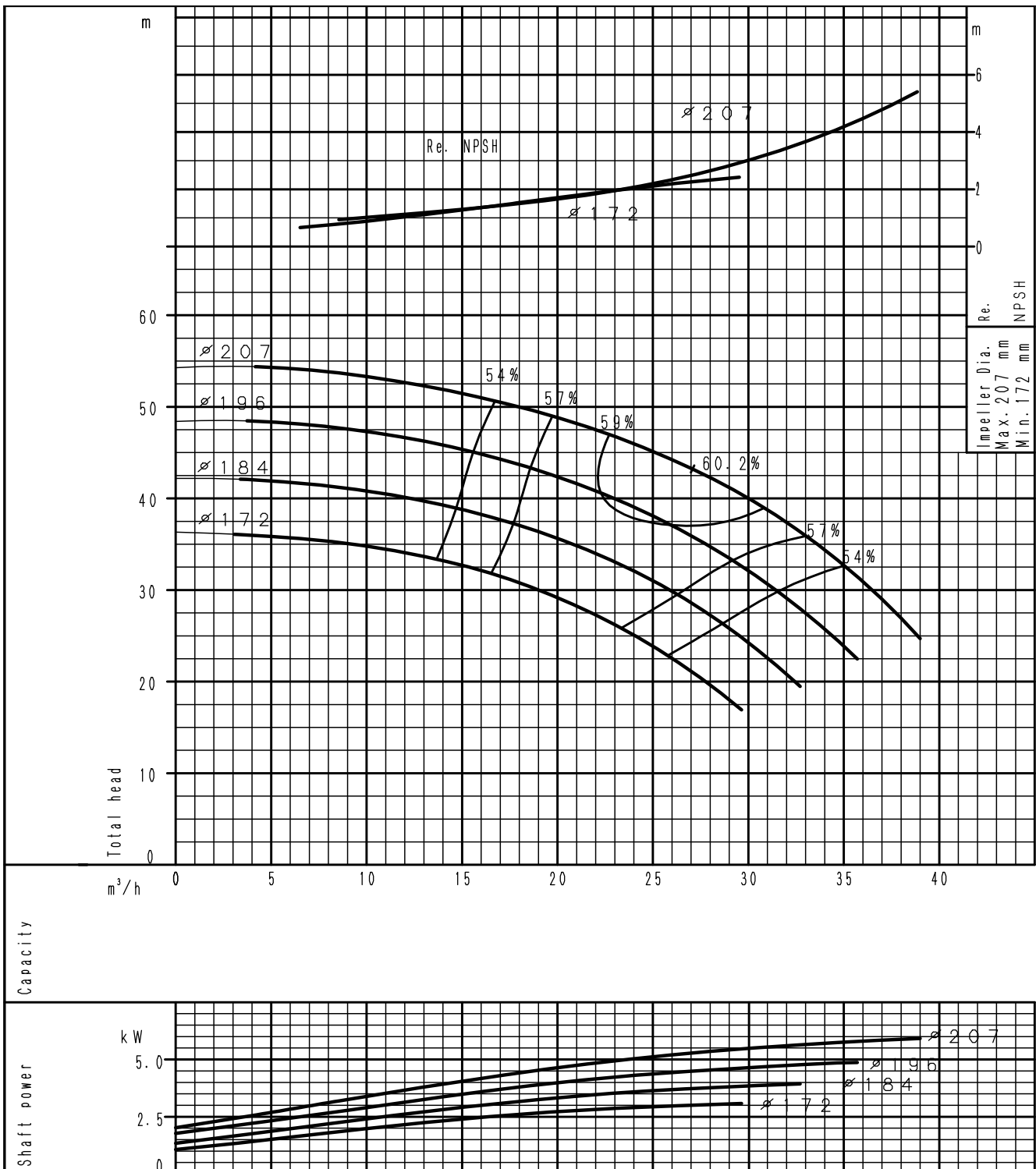

(speed 2900<sup>-1</sup>) According to ISO 9906 grade 3B

PERFORMANCE CURVE

GS 32-125

2 poles

PERFORMANCE CURVES

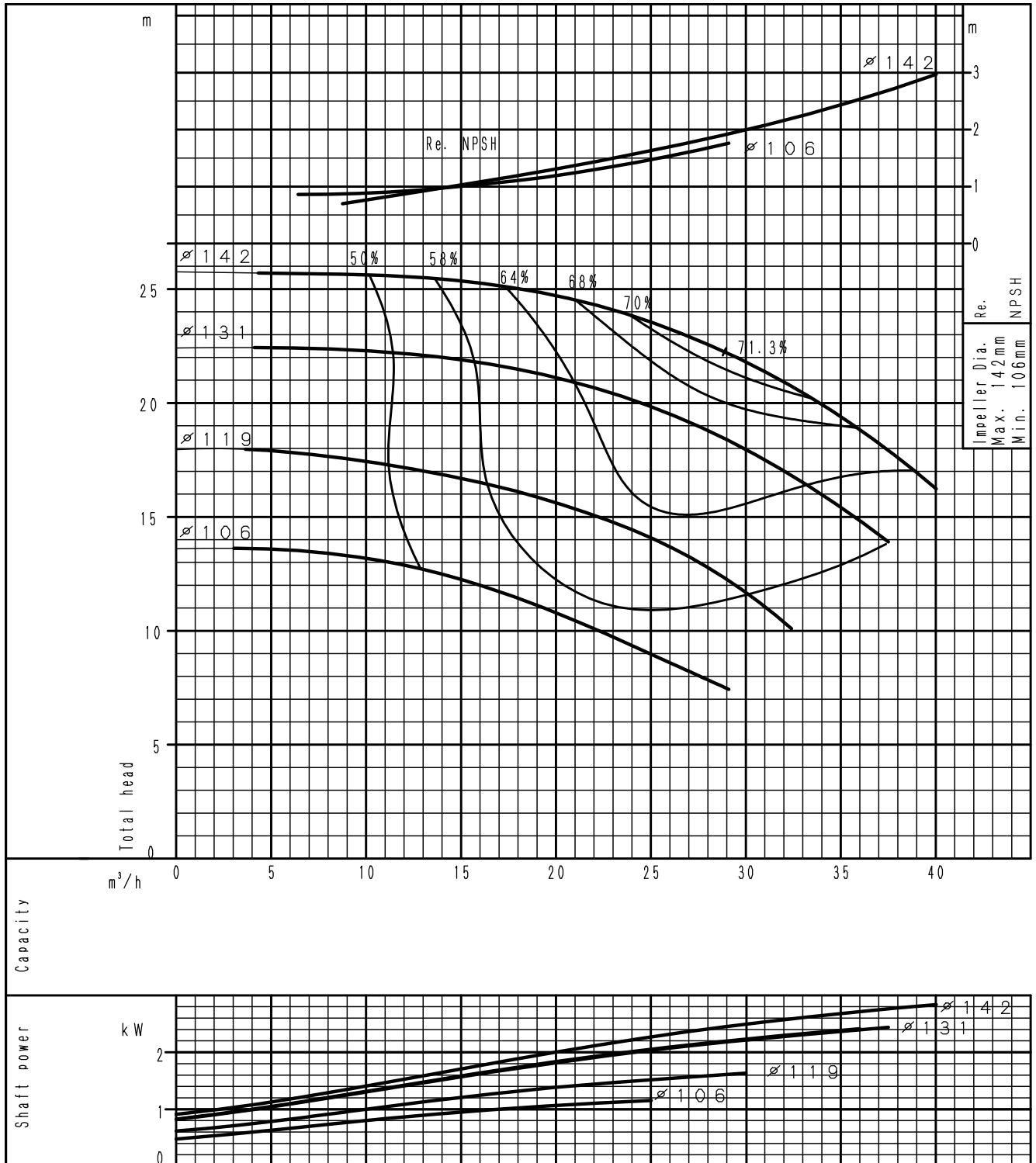

(speed 2900<sup>-1</sup>) According to ISO 9906 grade 3B

### PERFORMANCE CURVE GS 32-160

2 poles

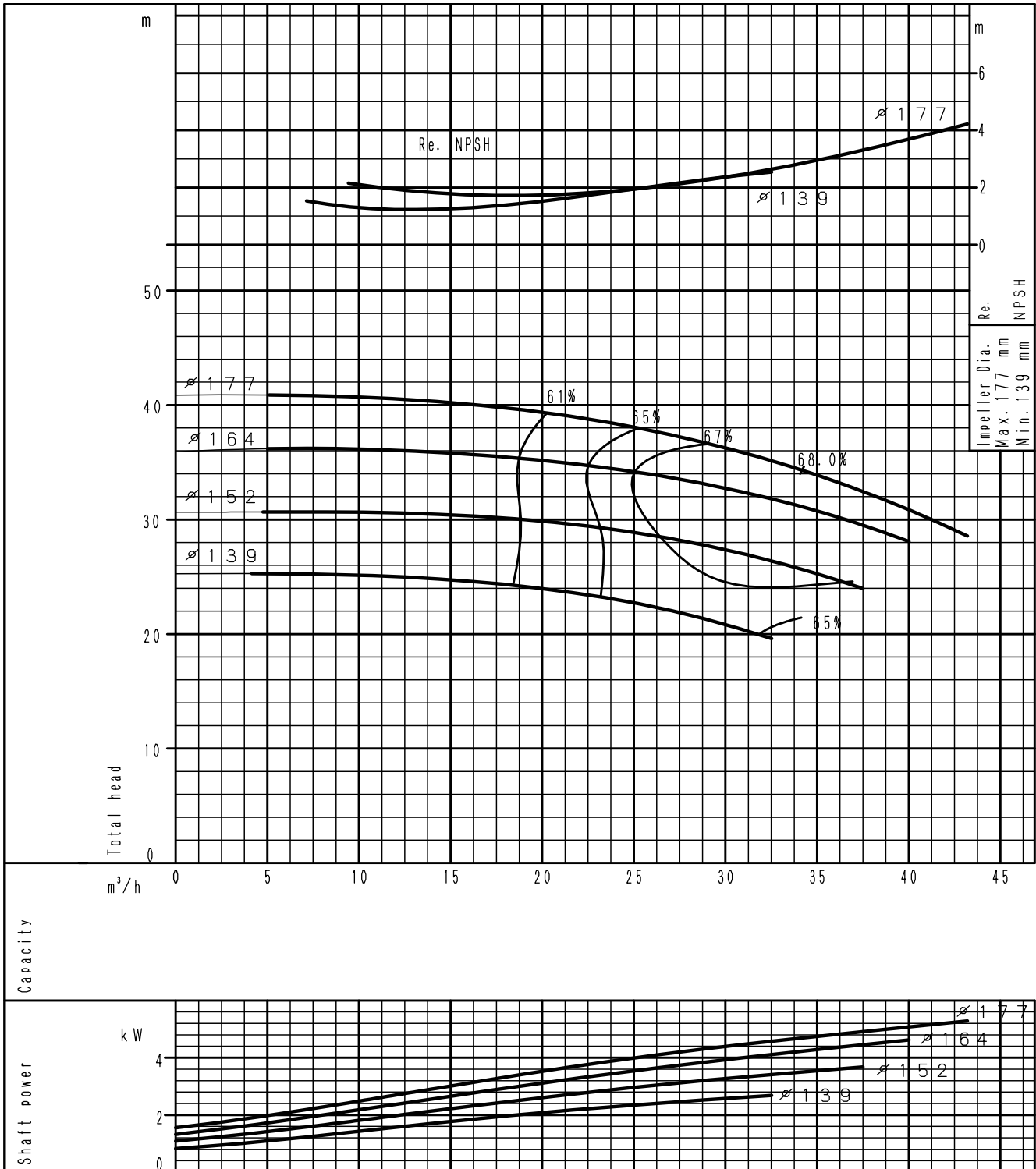

(speed 2900<sup>-1</sup>) According to ISO 9906 grade 3B

PERFORMANCE CURVE  
GS 32-200

2 poles

PERFORMANCE CURVES

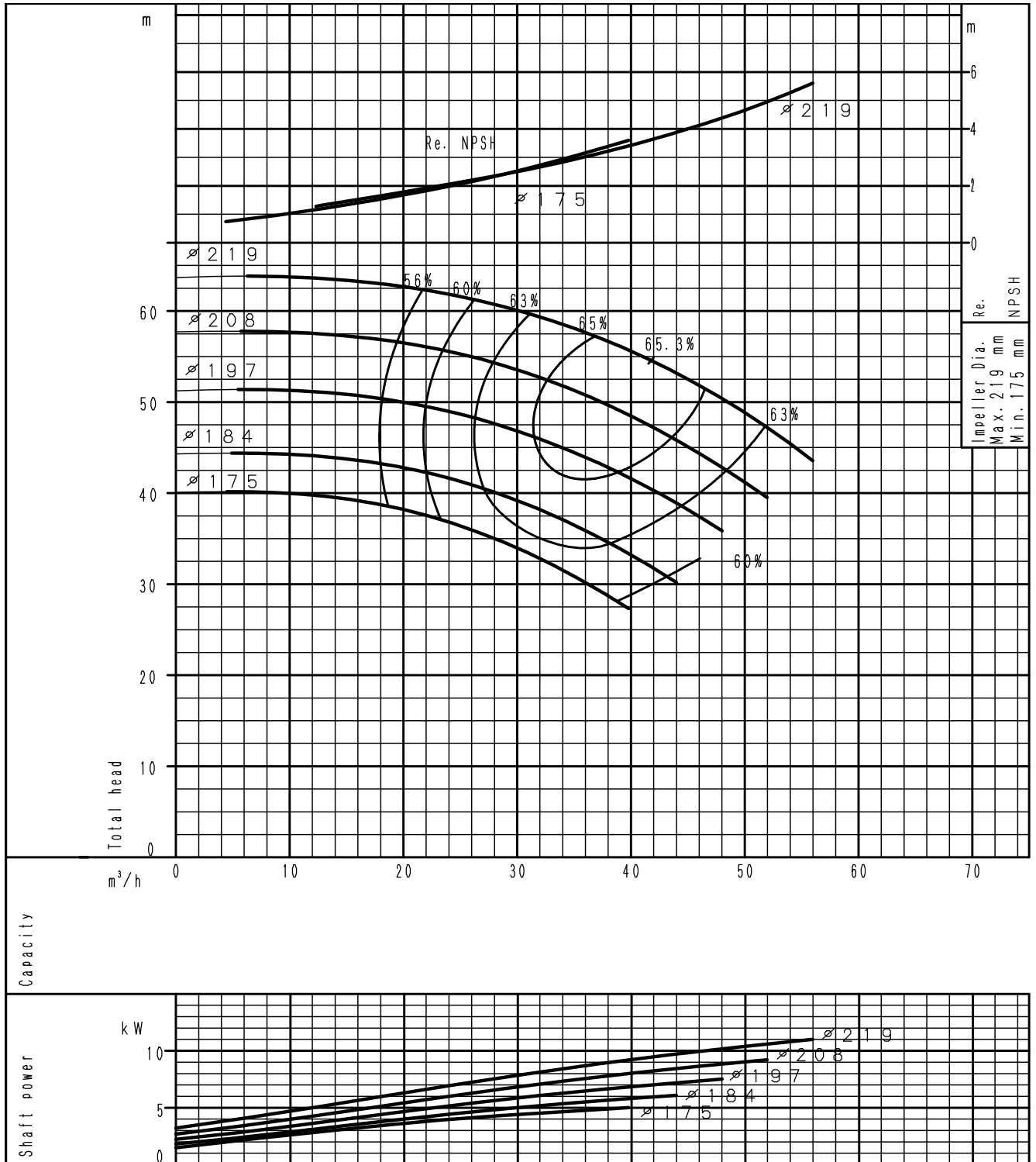

(speed 2900<sup>-1</sup>) According to ISO 9906 grade 3B

### PERFORMANCE CURVE GS 32-250

2 poles

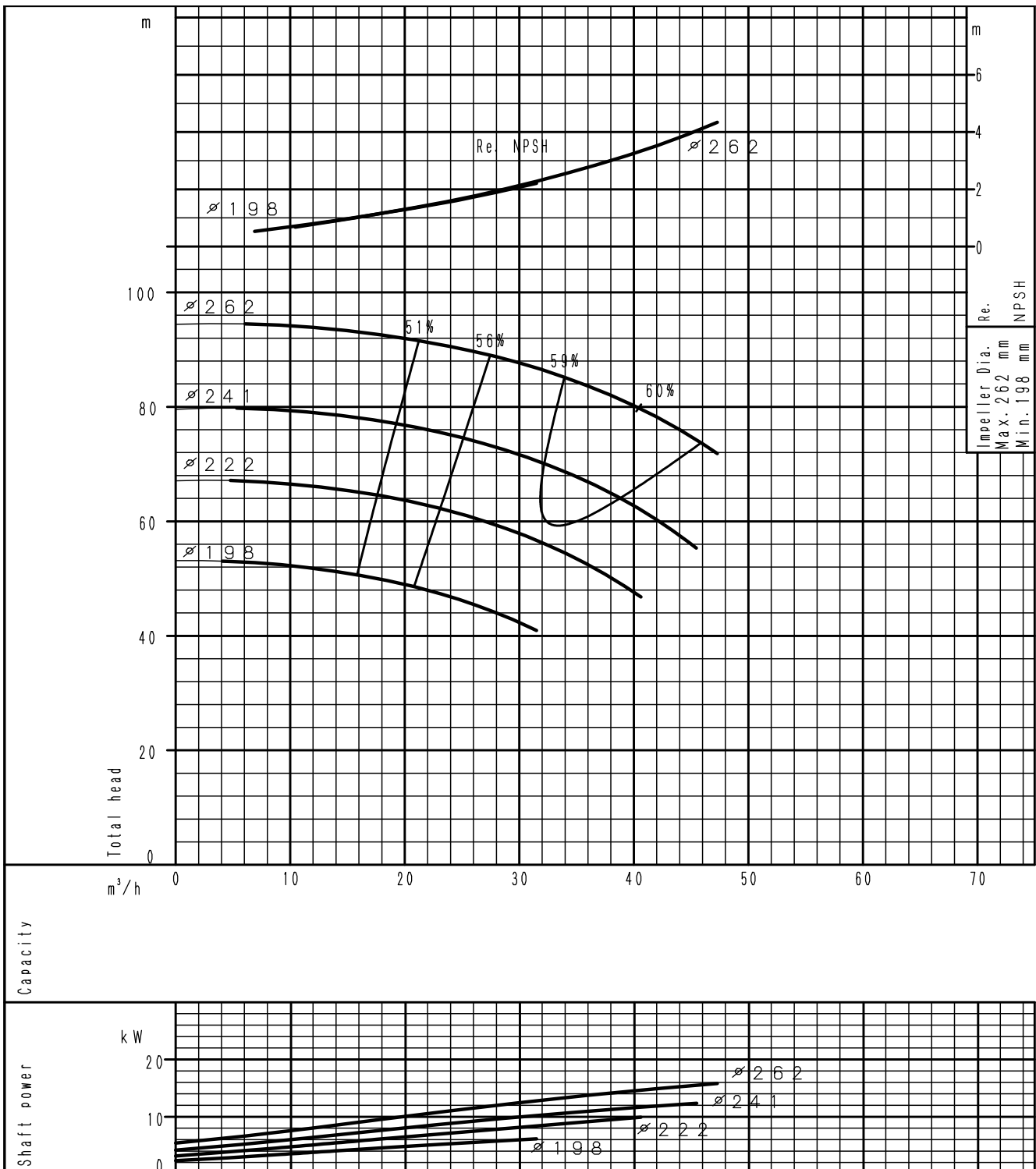

(speed 2900<sup>-1</sup>) According to ISO 9906 grade 3B

PERFORMANCE CURVE

GS 40-125

2 poles

PERFORMANCE CURVES

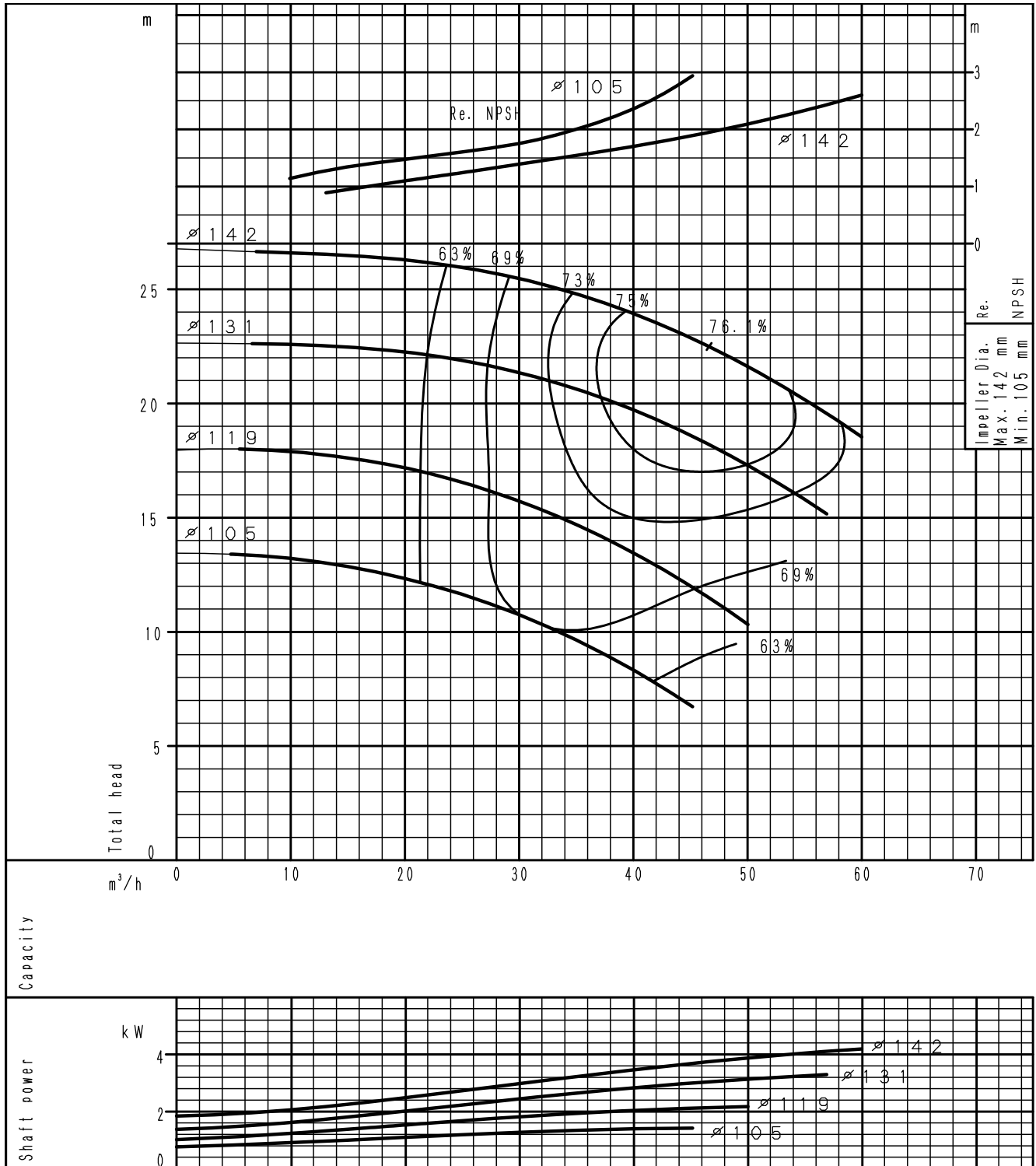

(speed 2900<sup>-1</sup>) According to ISO 9906 grade 3B



### PERFORMANCE CURVE GS 40-160

2 poles

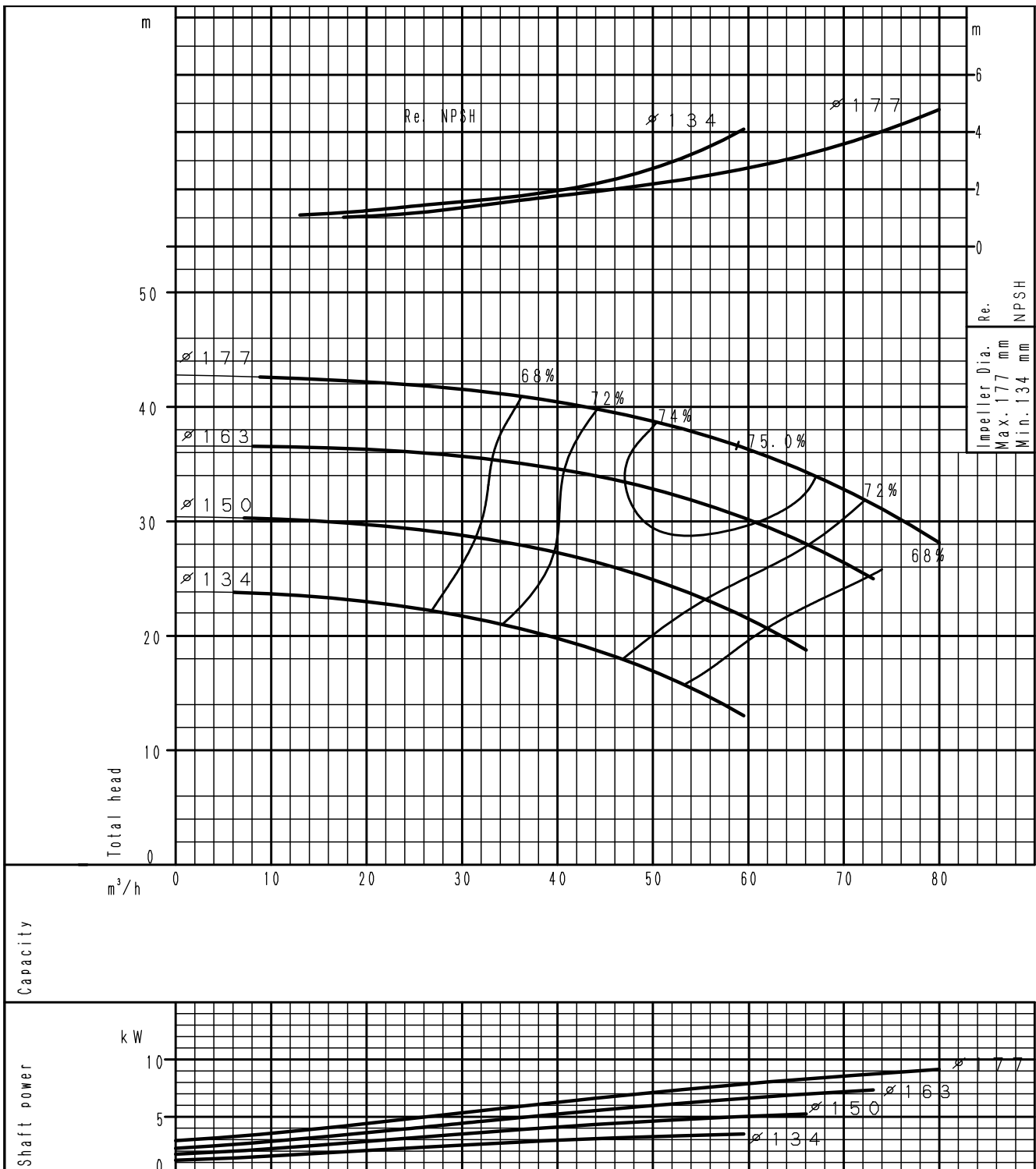

(speed 2900<sup>-1</sup>) According to ISO 9906 grade 3B

PERFORMANCE CURVE

GS 40-200

2 poles

PERFORMANCE CURVES

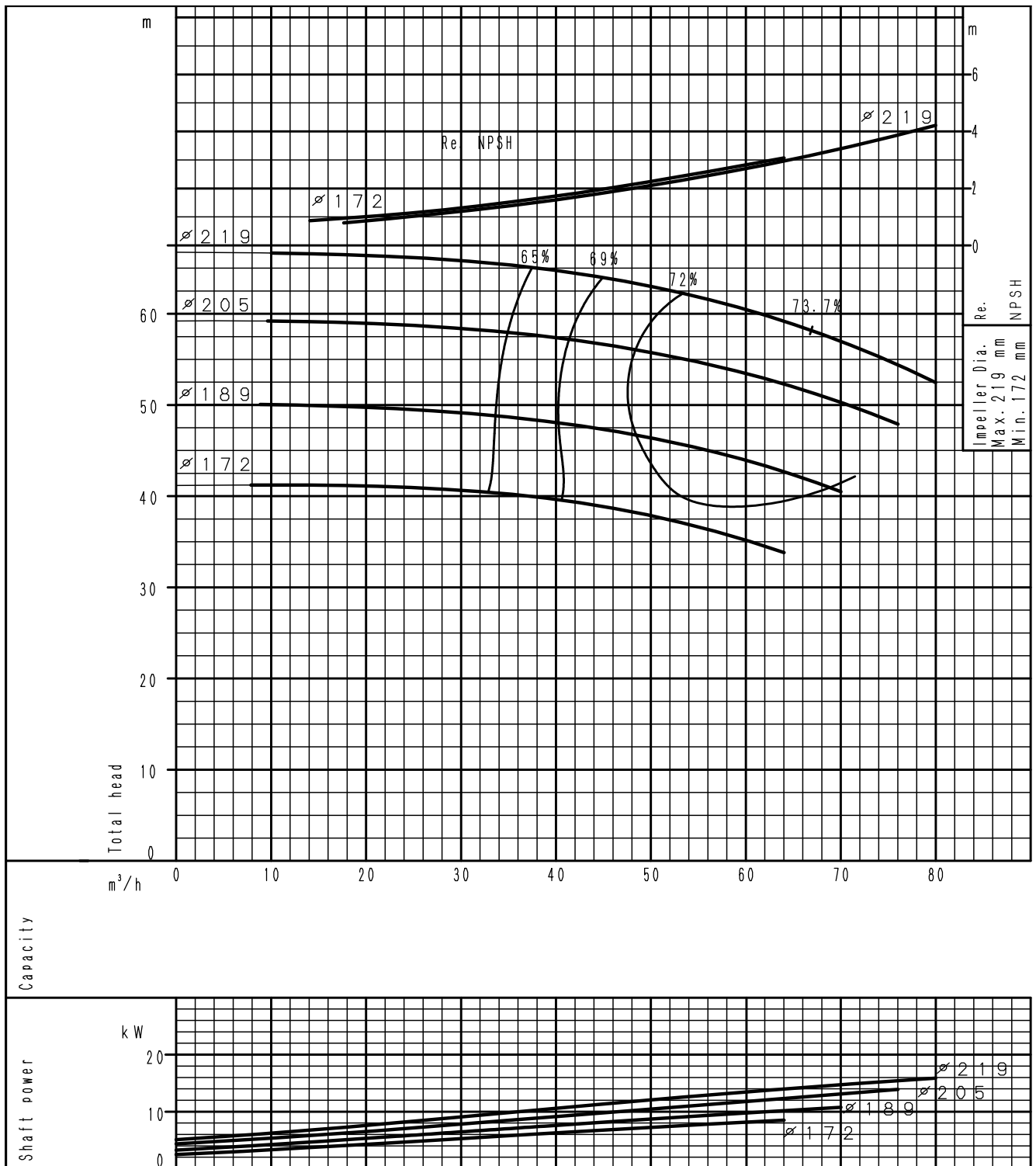

(speed 2900<sup>-1</sup>) According to ISO 9906 grade 3B

### PERFORMANCE CURVE GS 40-250

2 poles

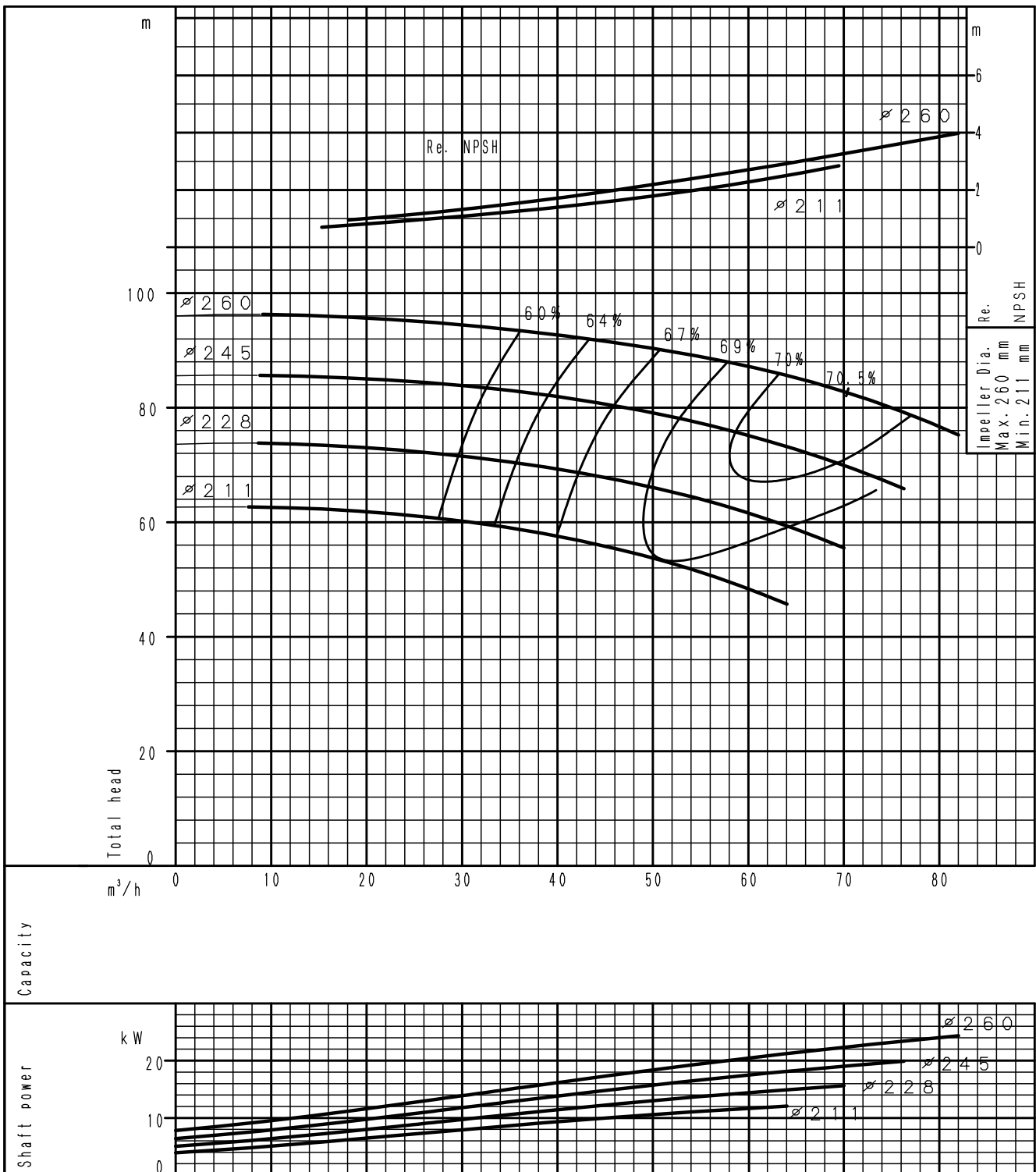

(speed 2900<sup>-1</sup>) According to ISO 9906 grade 3B

PERFORMANCE CURVE  
GS 40-315

2 poles

PERFORMANCE CURVES

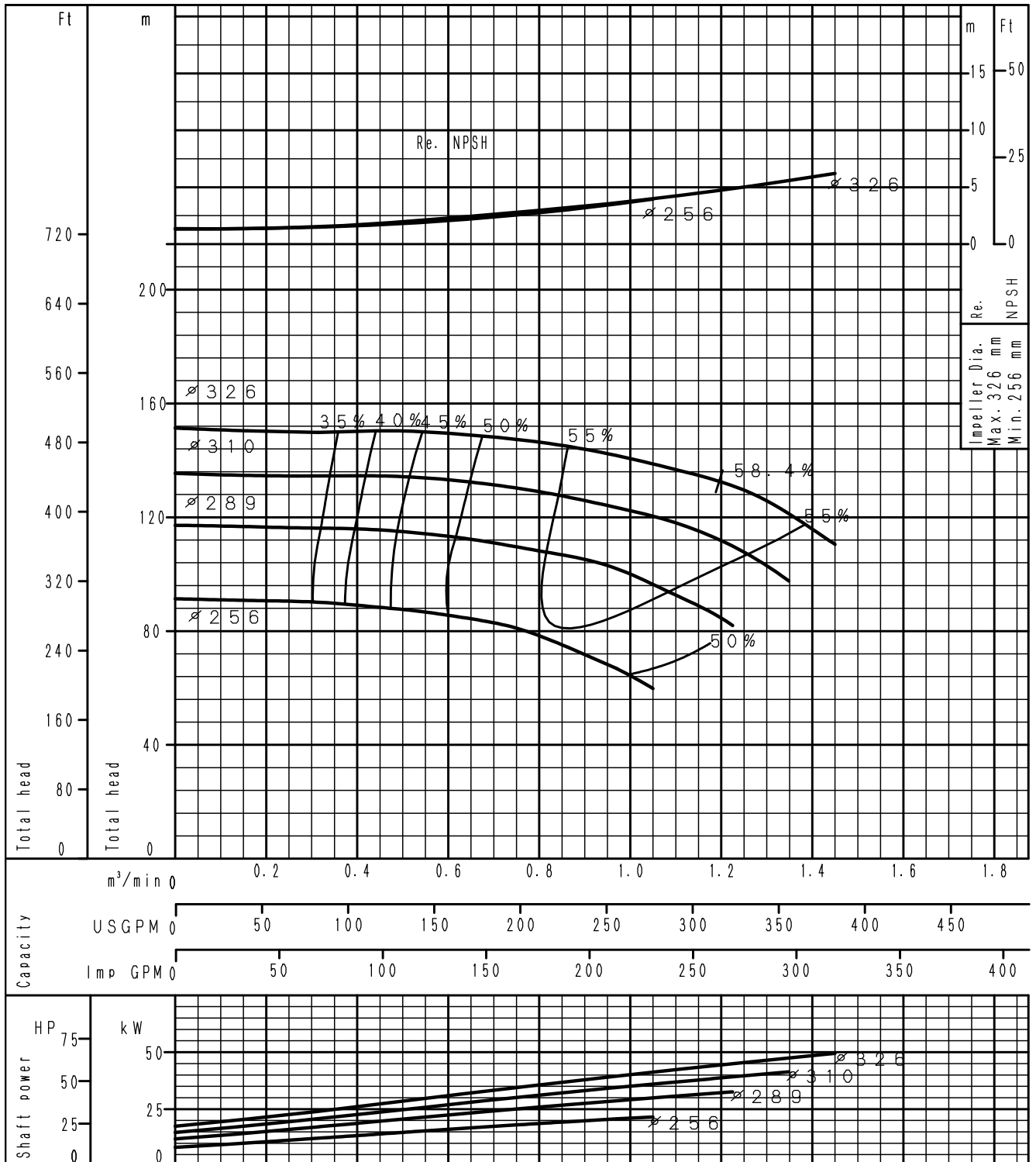

(speed 2900<sup>-1</sup>) According to ISO 9906 grade 3B

### PERFORMANCE CURVE GS 50-125

2 poles

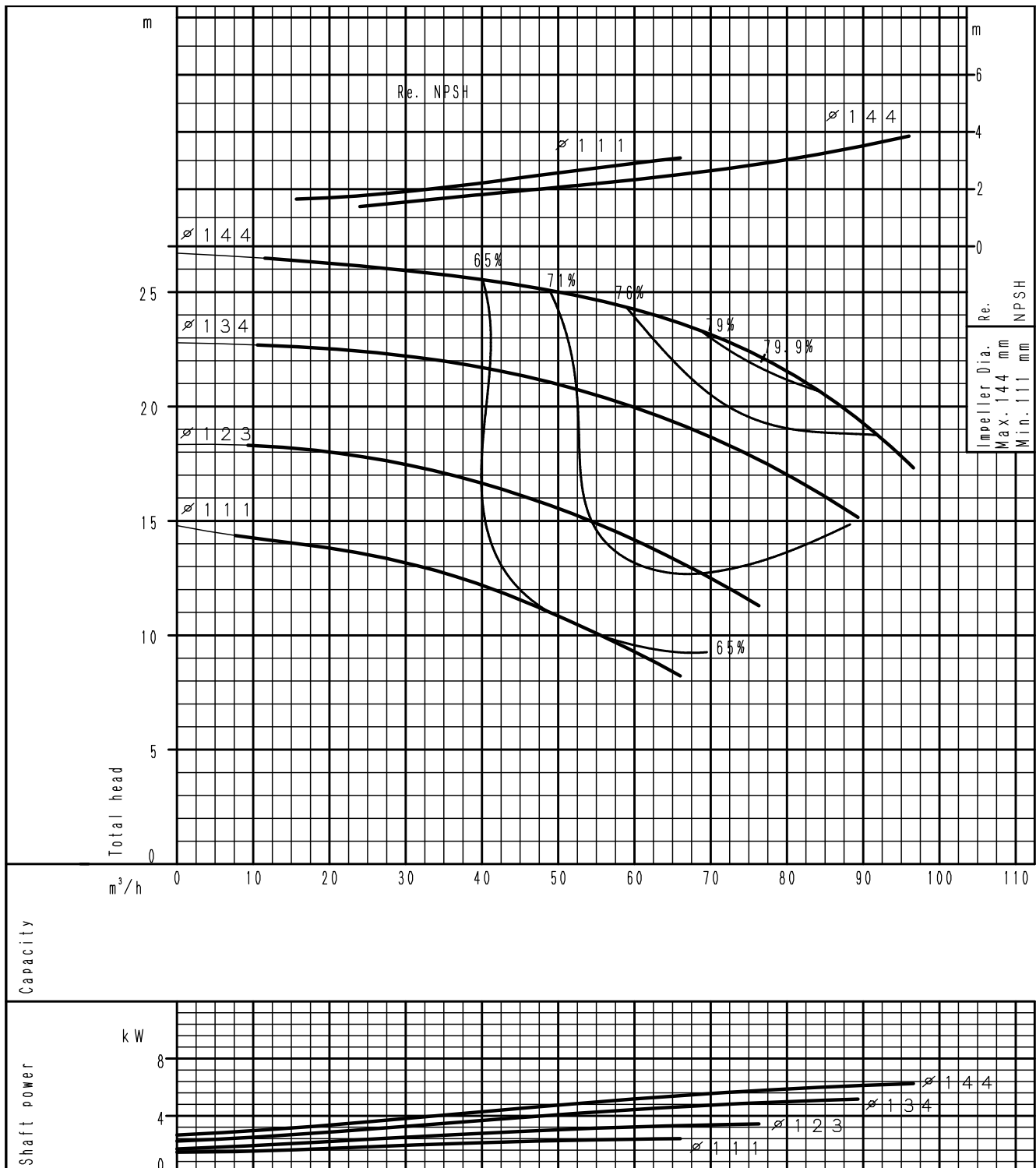

(speed 2900<sup>-1</sup>) According to ISO 9906 grade 3B

PERFORMANCE CURVES

PERFORMANCE CURVE  
GS 50-160

2 poles

PERFORMANCE CURVES

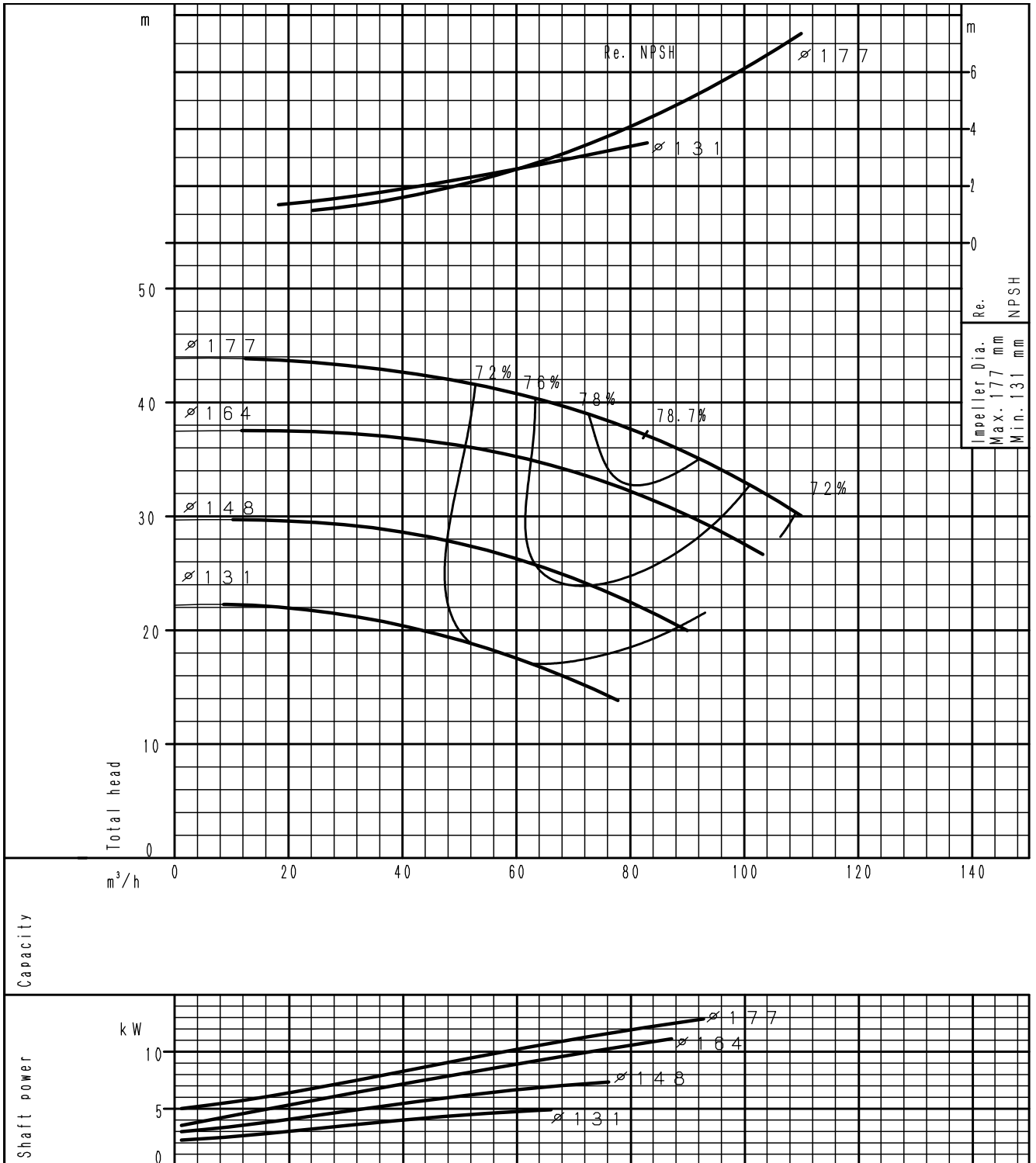

(speed 2900<sup>-1</sup>) According to ISO 9906 grade 3B

### PERFORMANCE CURVE GS 50-200

2 poles

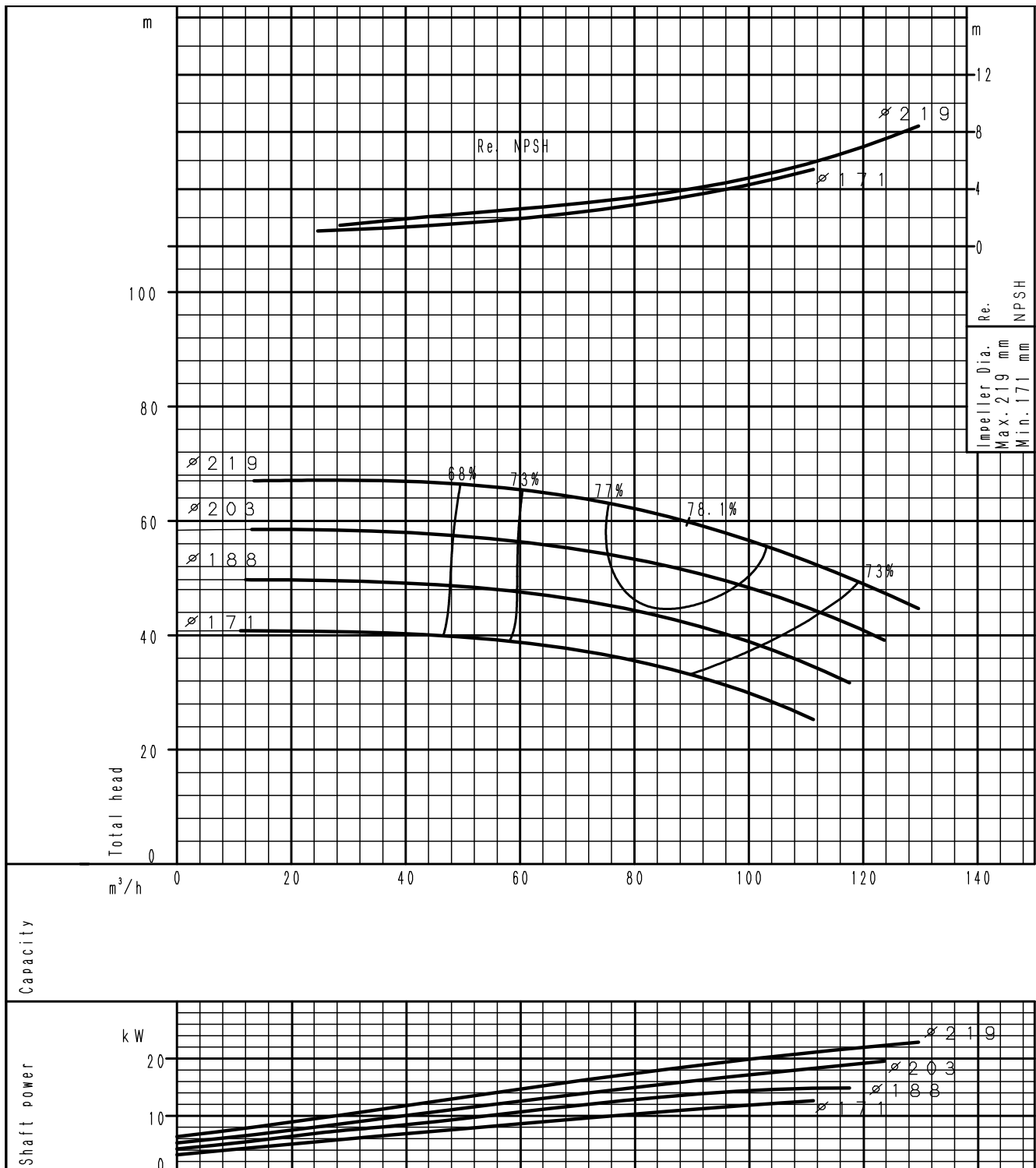

(speed 2900<sup>-1</sup>) According to ISO 9906 grade 3B

PERFORMANCE CURVE  
GS 50-250

2 poles

PERFORMANCE CURVES

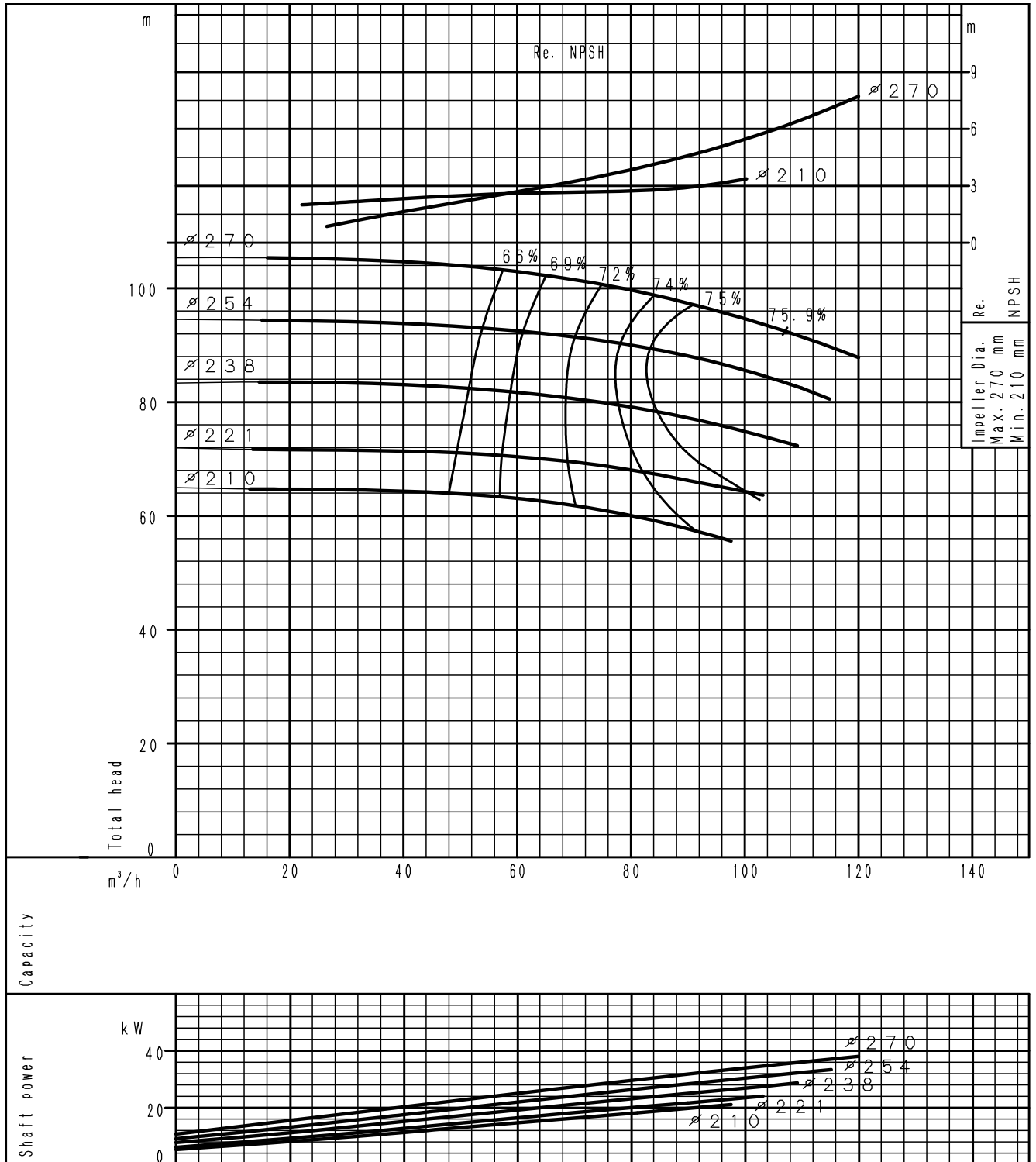

(speed 2900<sup>-1</sup>) According to ISO 9906 grade 3B



### PERFORMANCE CURVE GS 50-315

2 poles

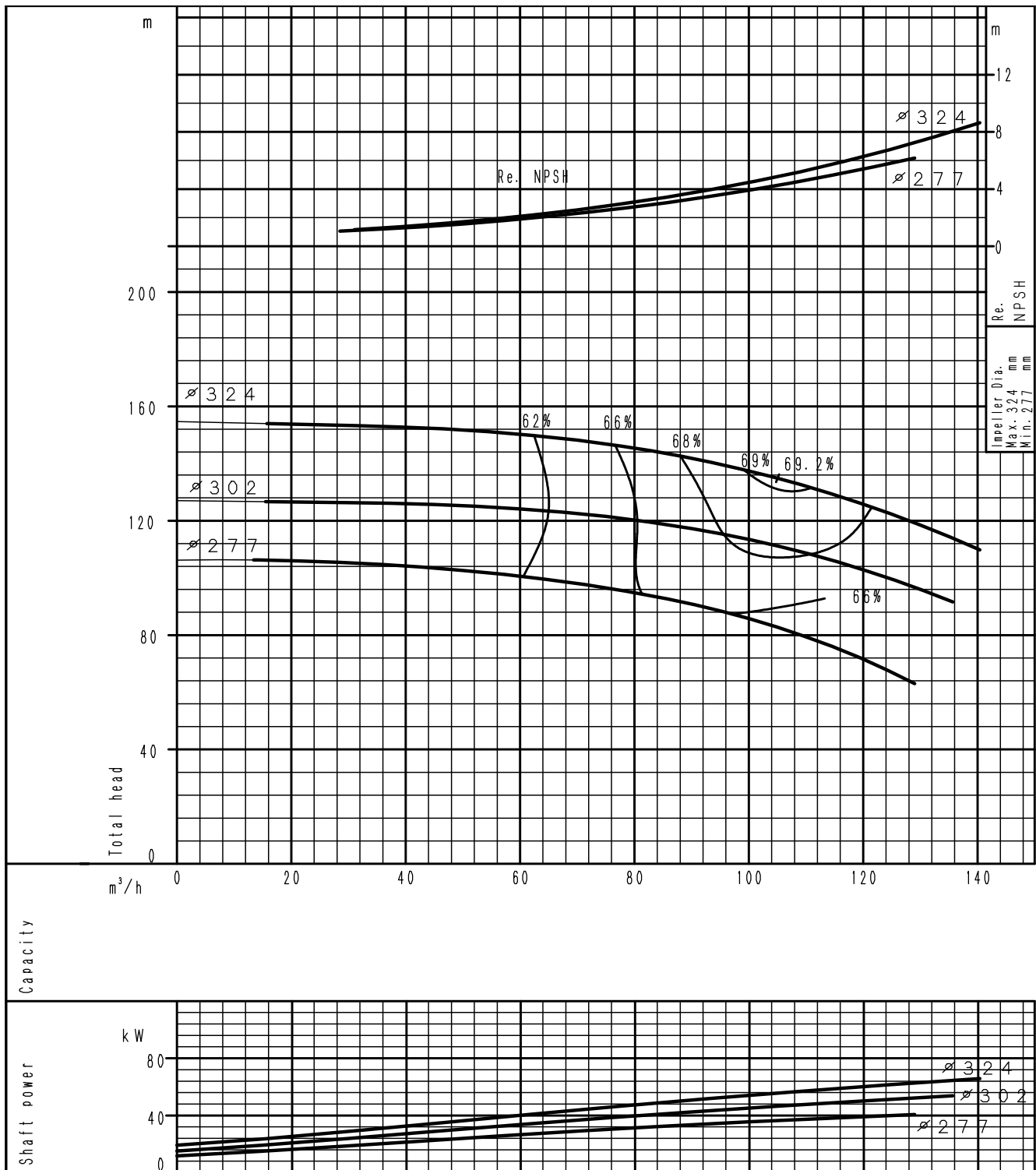

(speed 2900<sup>-1</sup>) According to ISO 9906 grade 3B

PERFORMANCE CURVE

GS 65-125

2 poles

PERFORMANCE CURVES

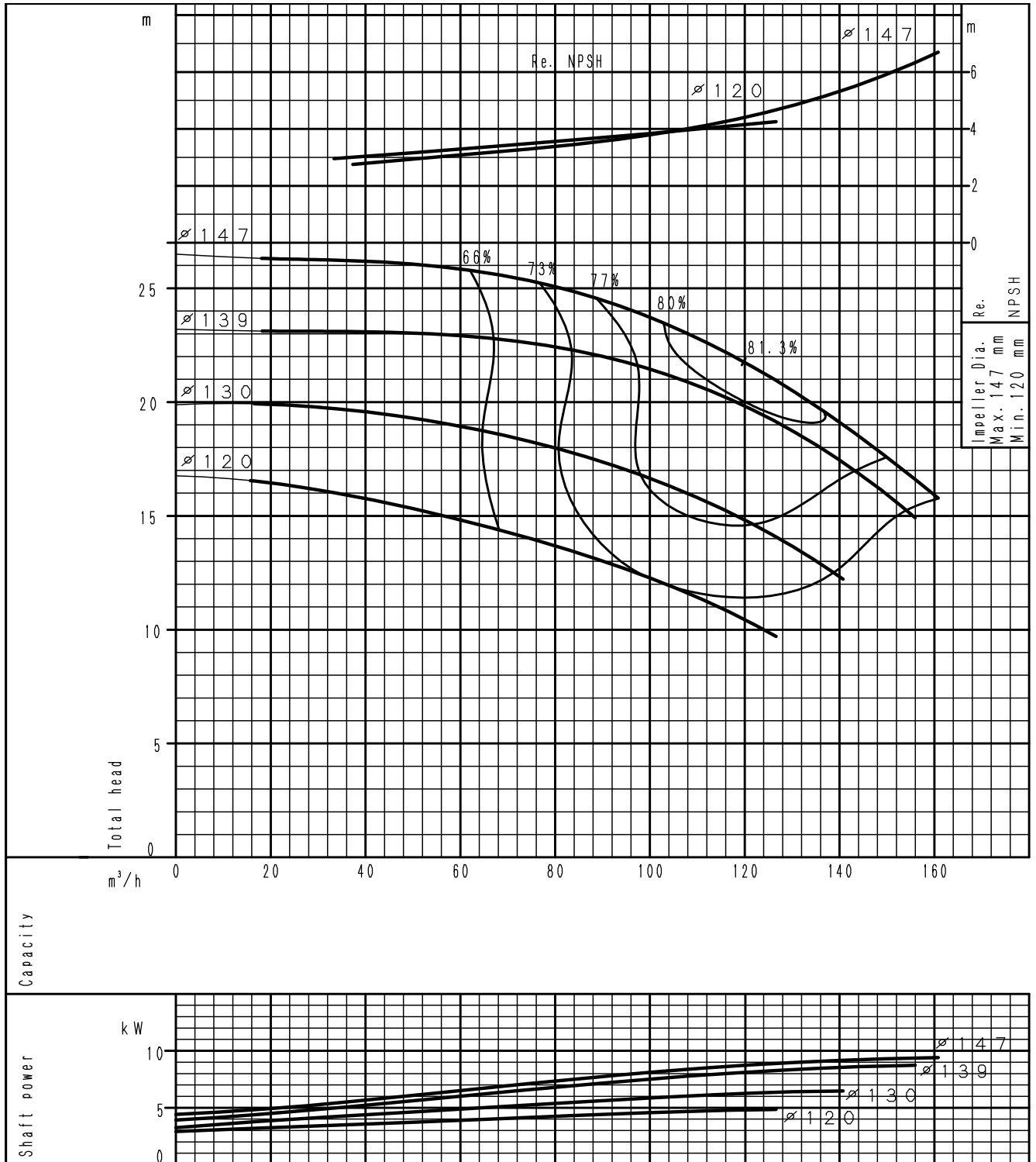

(speed 2900<sup>-1</sup>) According to ISO 9906 grade 3B

### PERFORMANCE CURVE GS 65-160

2 poles

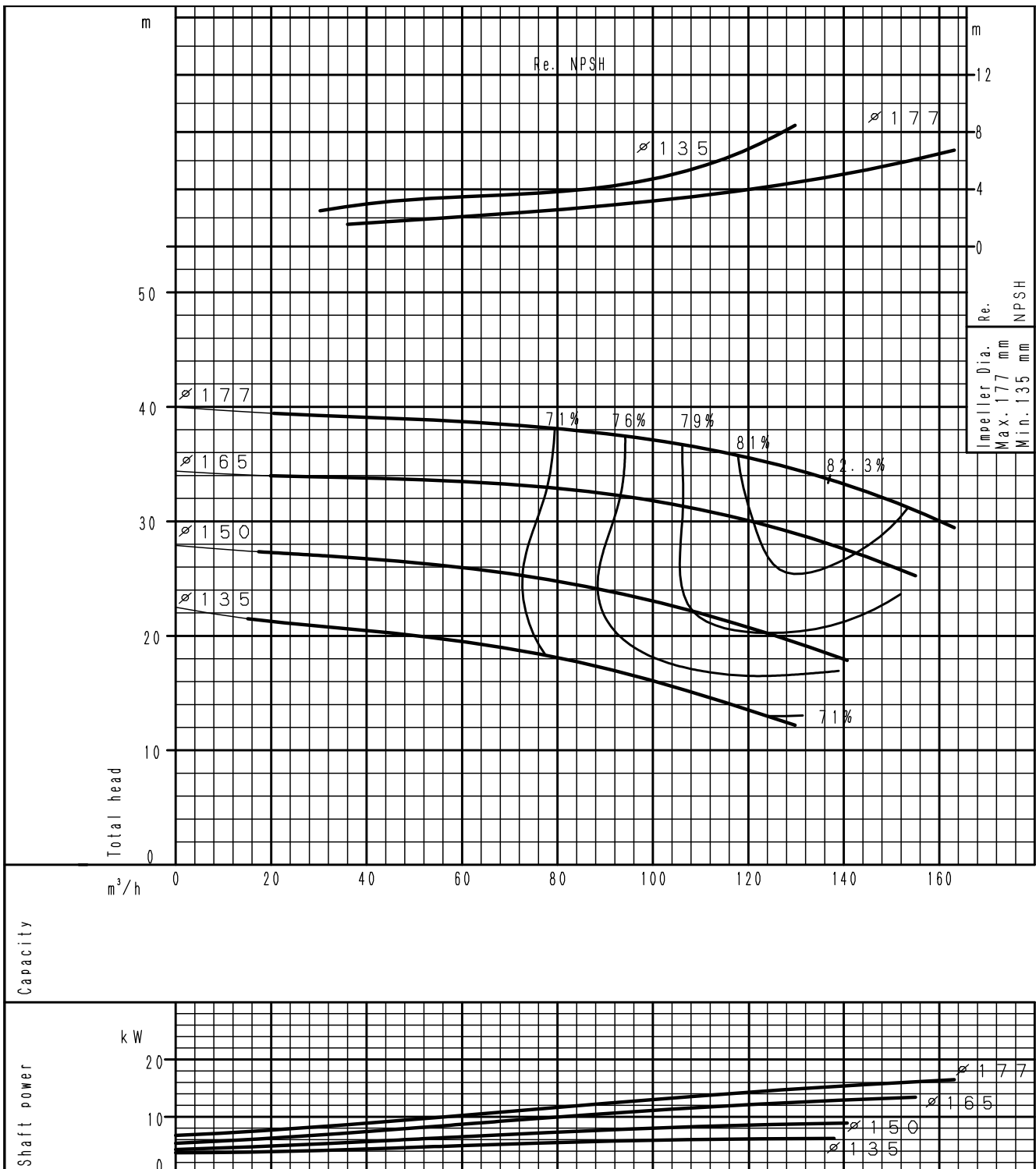

(speed 2900<sup>-1</sup>) According to ISO 9906 grade 3B

PERFORMANCE CURVE

GS 65-200

2 poles

PERFORMANCE CURVES

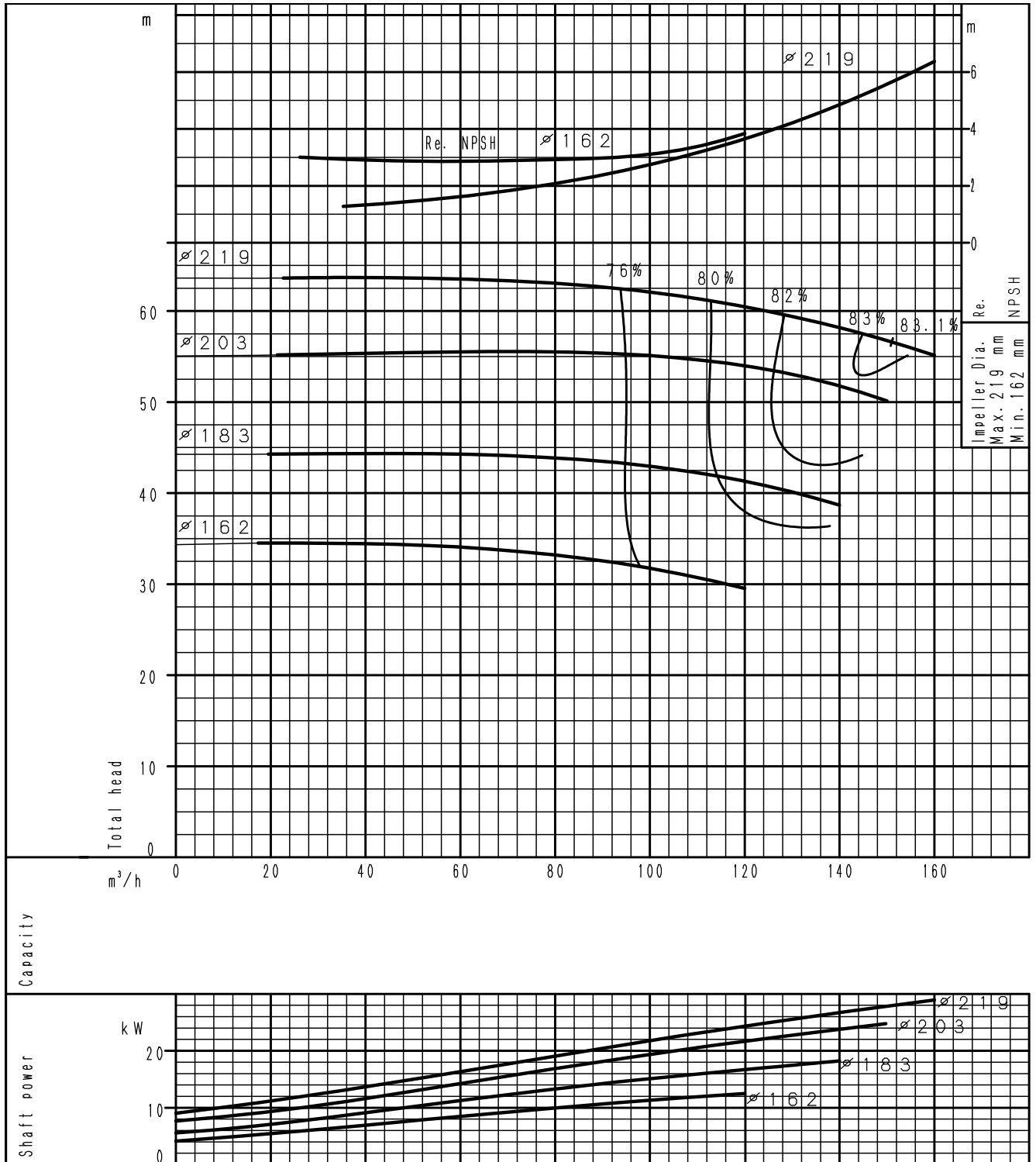

(speed 2900<sup>-1</sup>) According to ISO 9906 grade 3B

### PERFORMANCE CURVE GS 65-250

2 poles

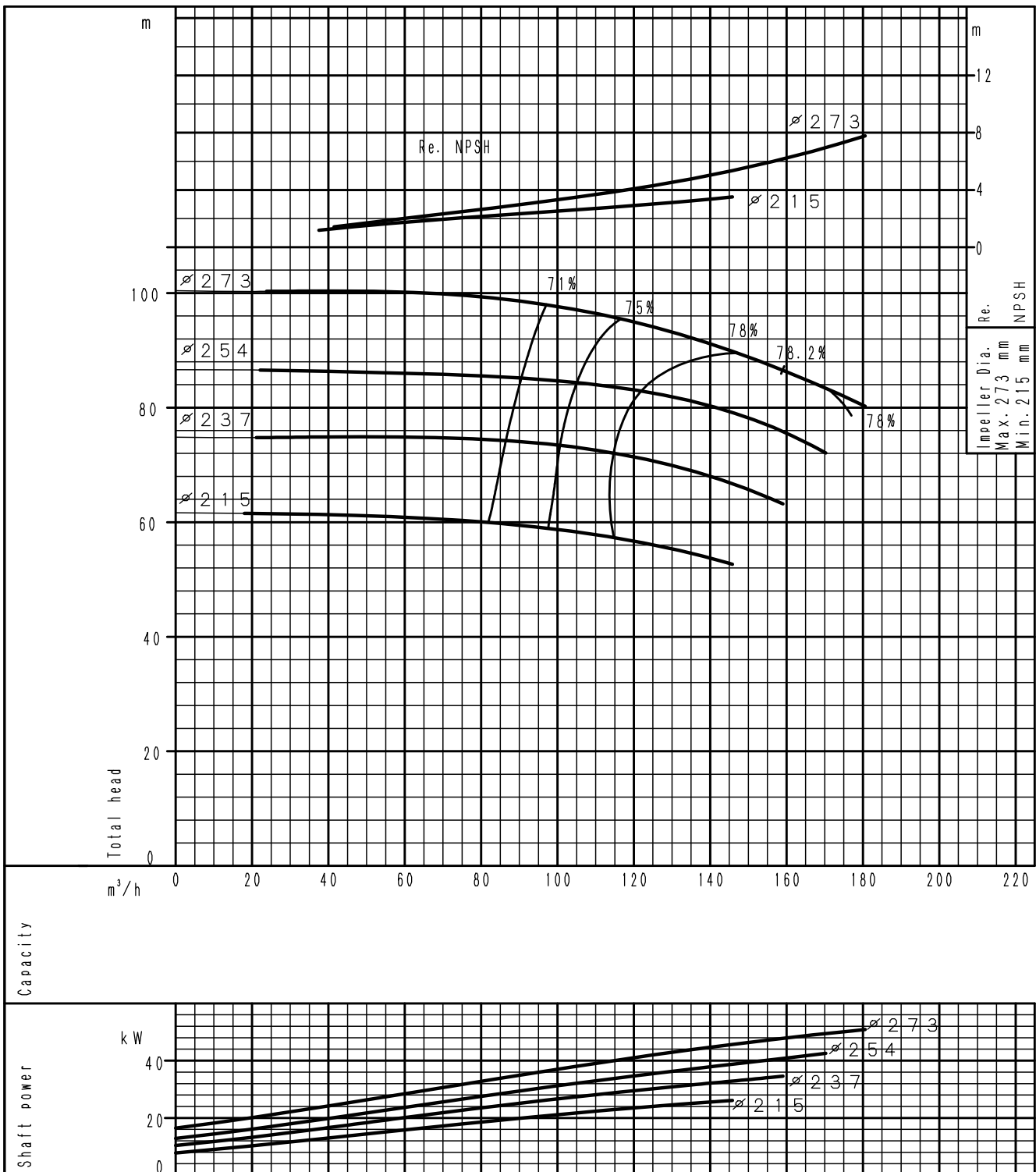

(speed 2900<sup>-1</sup>) According to ISO 9906 grade 3B

PERFORMANCE CURVE  
GS 65-315

2 poles

PERFORMANCE CURVES

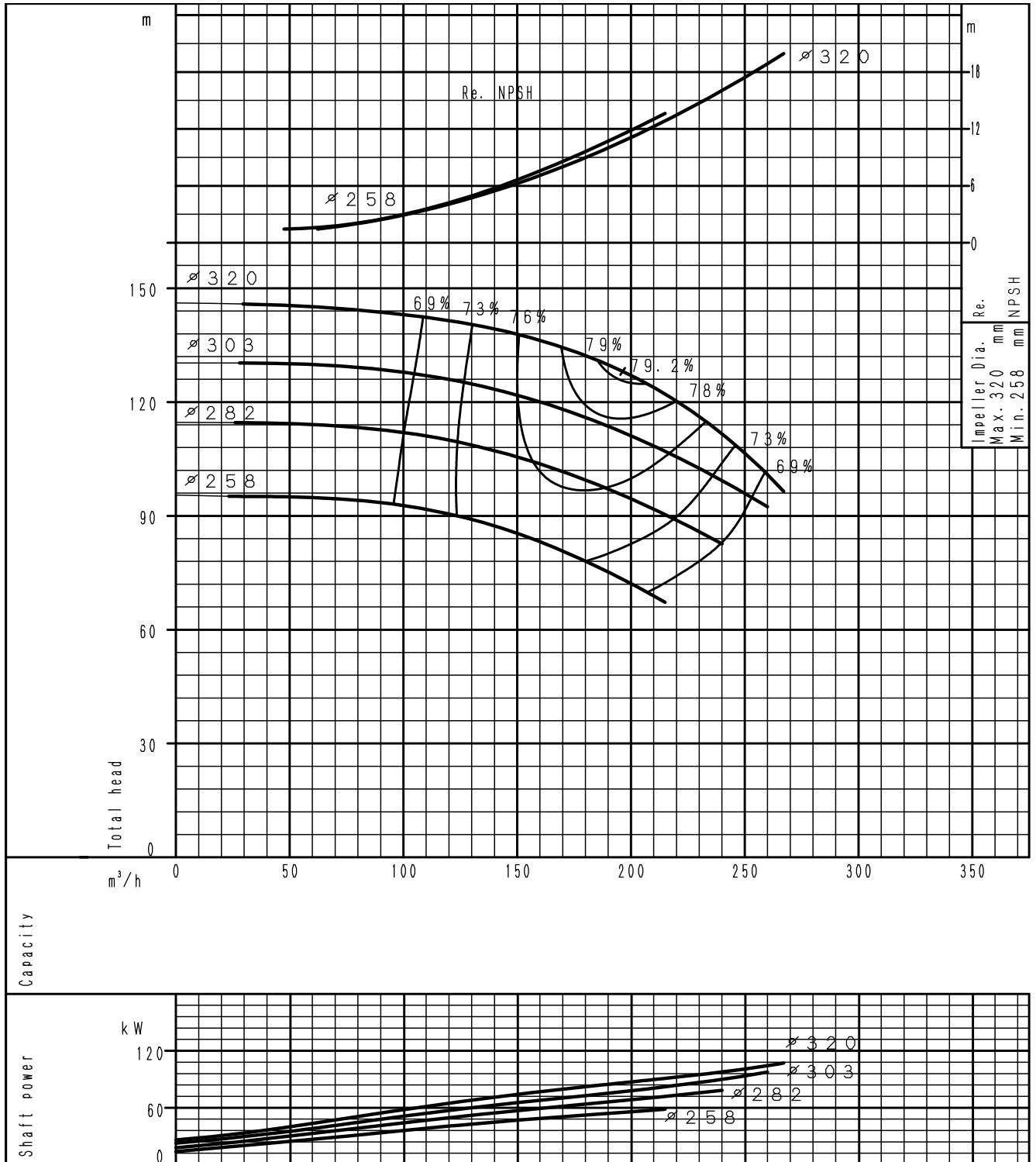

(speed 2900<sup>-1</sup>) According to ISO 9906 grade 3B

### PERFORMANCE CURVE GS 80-160

2 poles

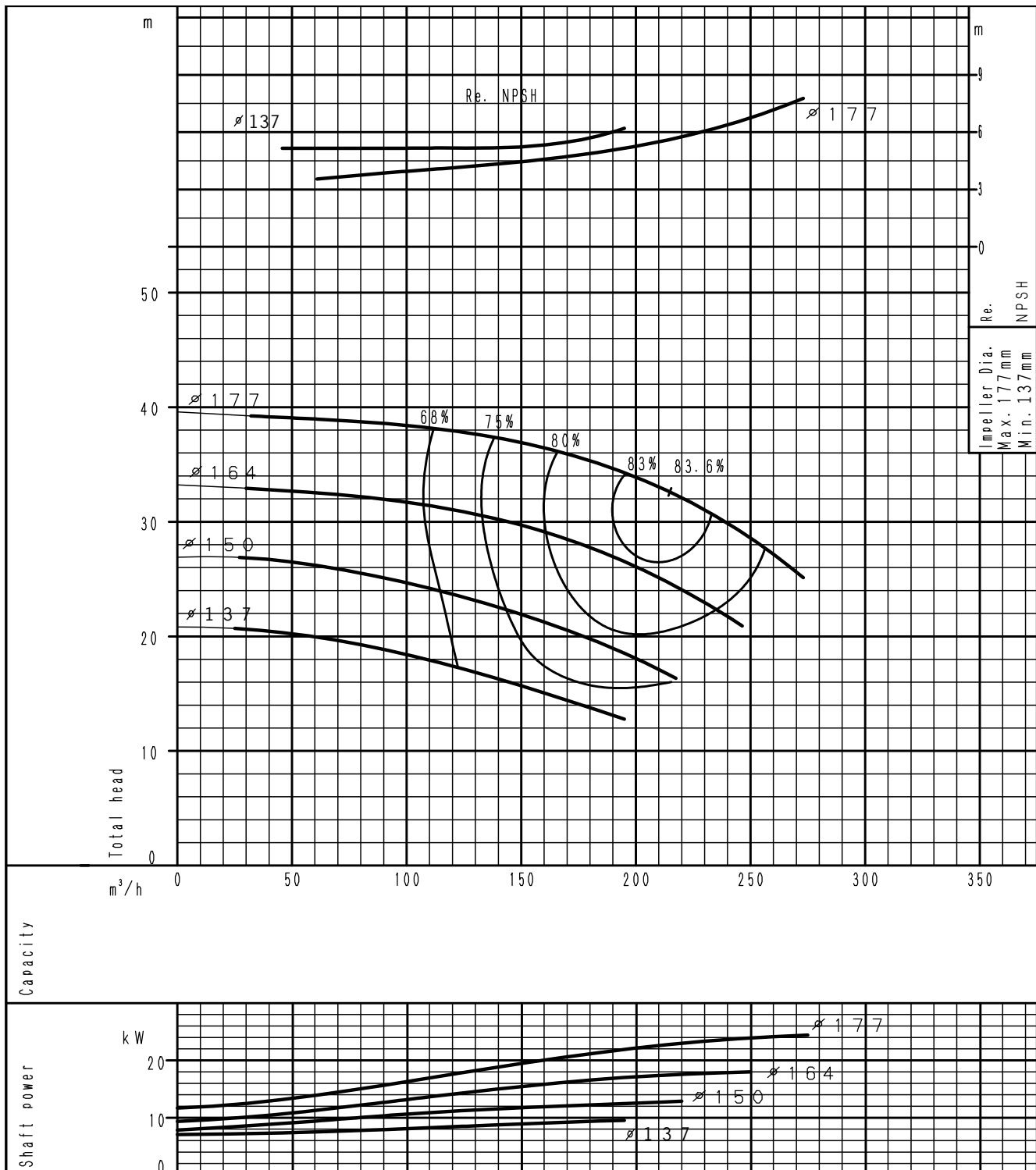

(speed 2900<sup>-1</sup>) According to ISO 9906 grade 3B

PERFORMANCE CURVE

GS 80-200

2 poles

PERFORMANCE CURVES

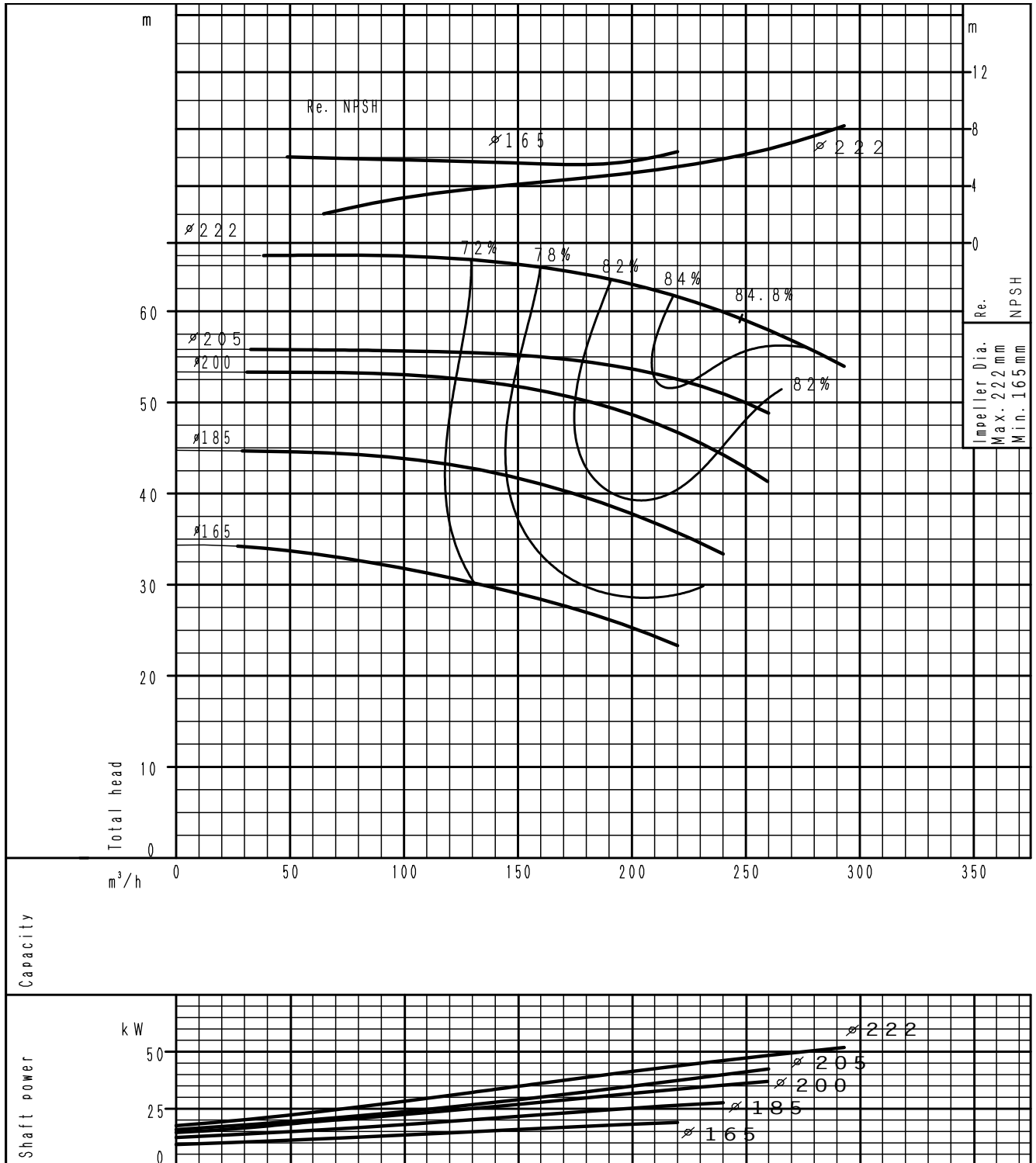

(speed 2900<sup>-1</sup>) According to ISO 9906 grade 3B



### PERFORMANCE CURVE GS 80-250

2 poles

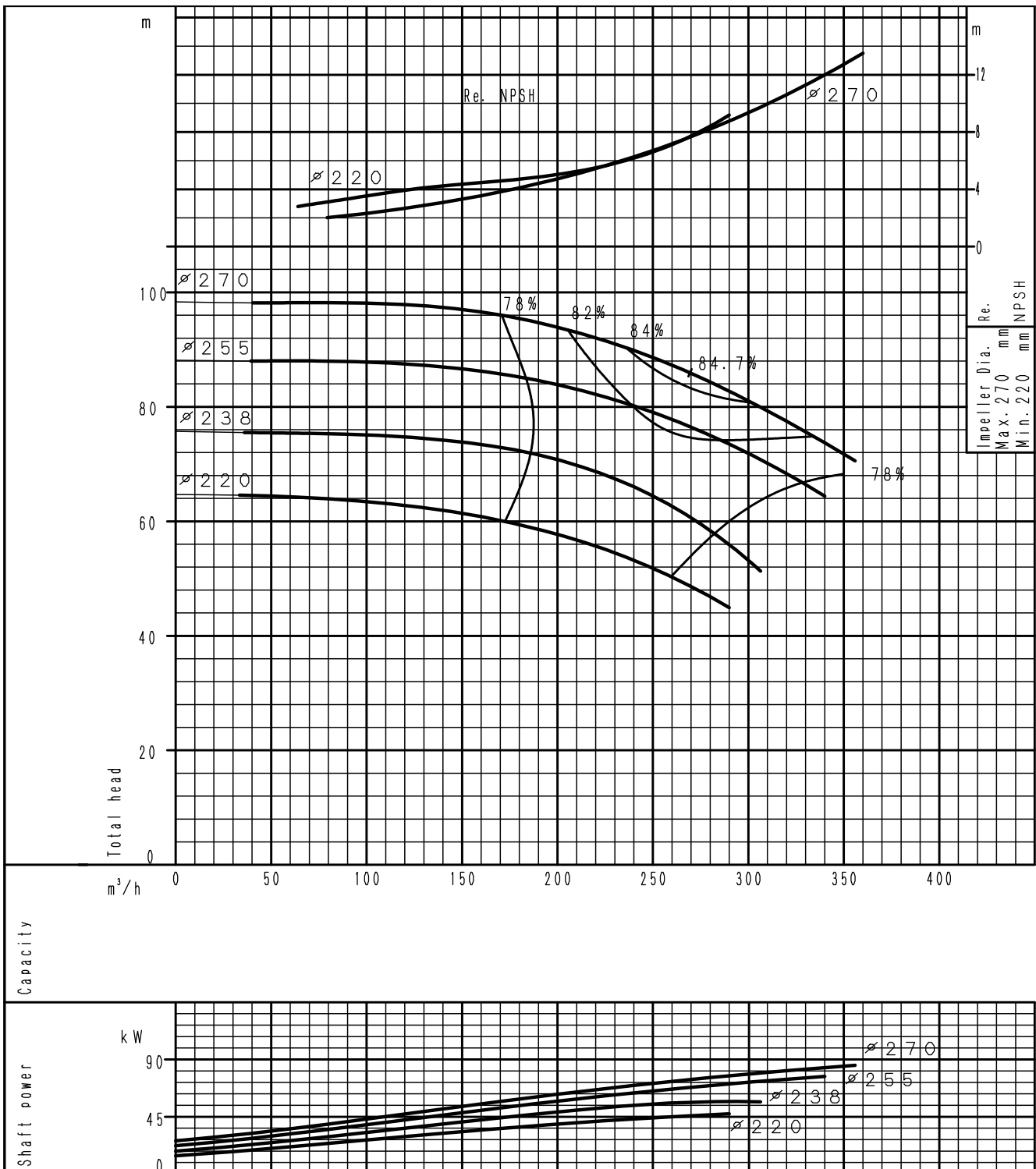

(speed 2900<sup>-1</sup>) According to ISO 9906 grade 3B

PERFORMANCE CURVE

GS 80-315L

2 poles

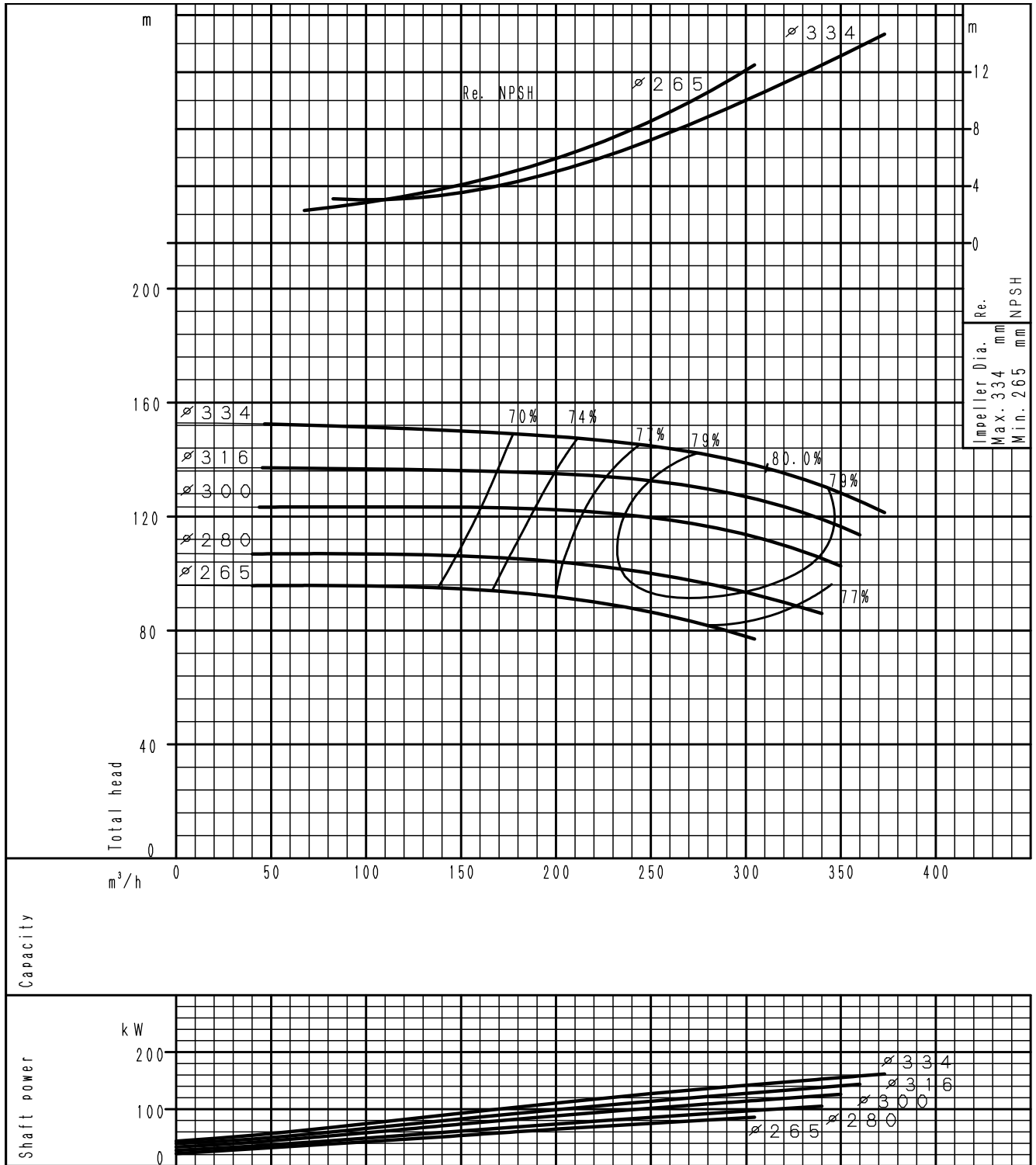

(speed 2900<sup>-1</sup>) According to ISO 9906 grade 3B

### PERFORMANCE CURVE GS 100-160

2 poles

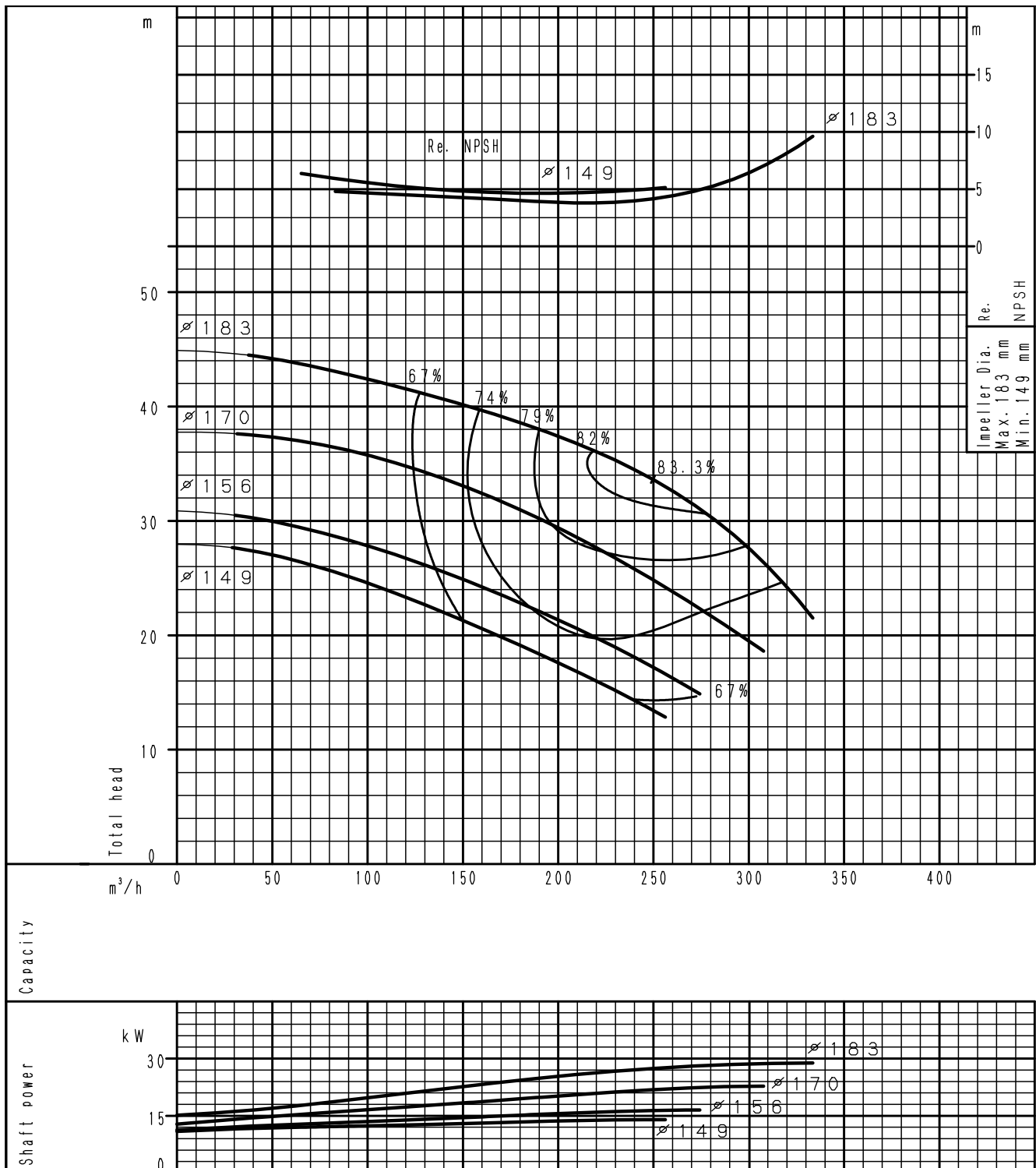

(speed 2900<sup>-1</sup>) According to ISO 9906 grade 3B

PERFORMANCE CURVE  
GS 100-200

2 poles

PERFORMANCE CURVES

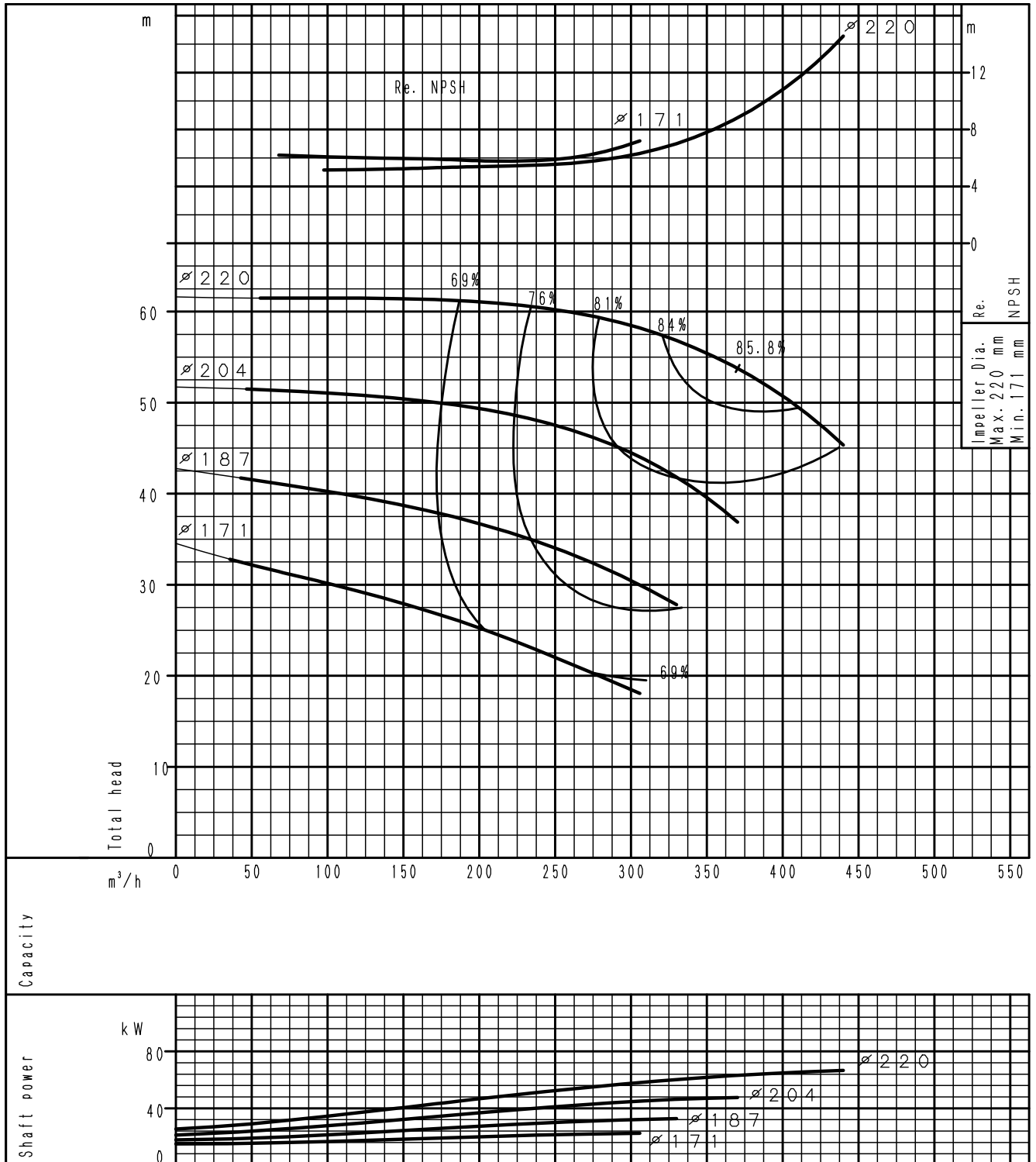

(speed 2900<sup>-1</sup>) According to ISO 9906 grade 3B

### PERFORMANCE CURVE GS 100-250

2 poles

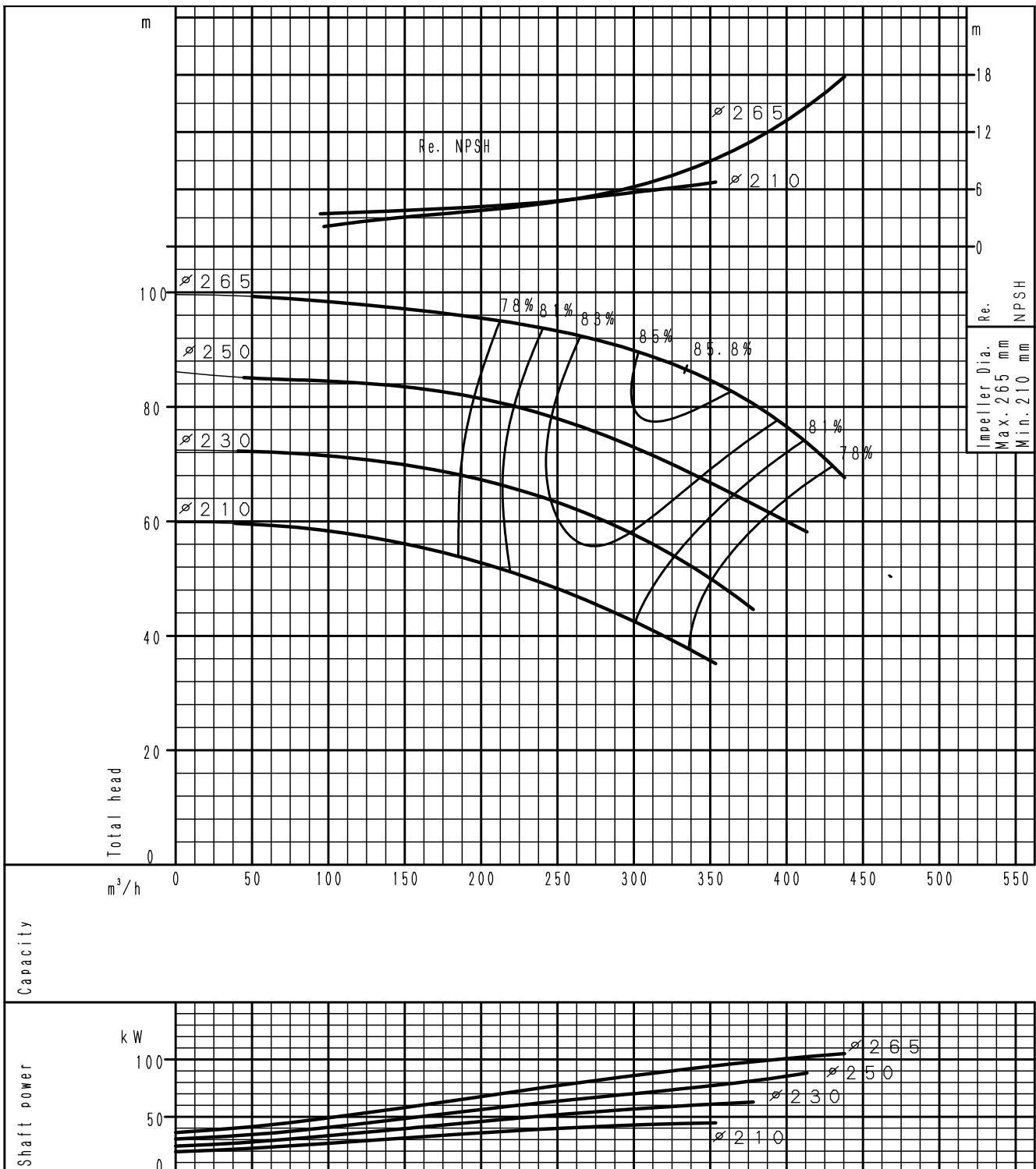

(speed 2900<sup>-1</sup>) According to ISO 9906 grade 3B

PERFORMANCE CURVE  
GS 100-315L

2 poles

PERFORMANCE CURVES

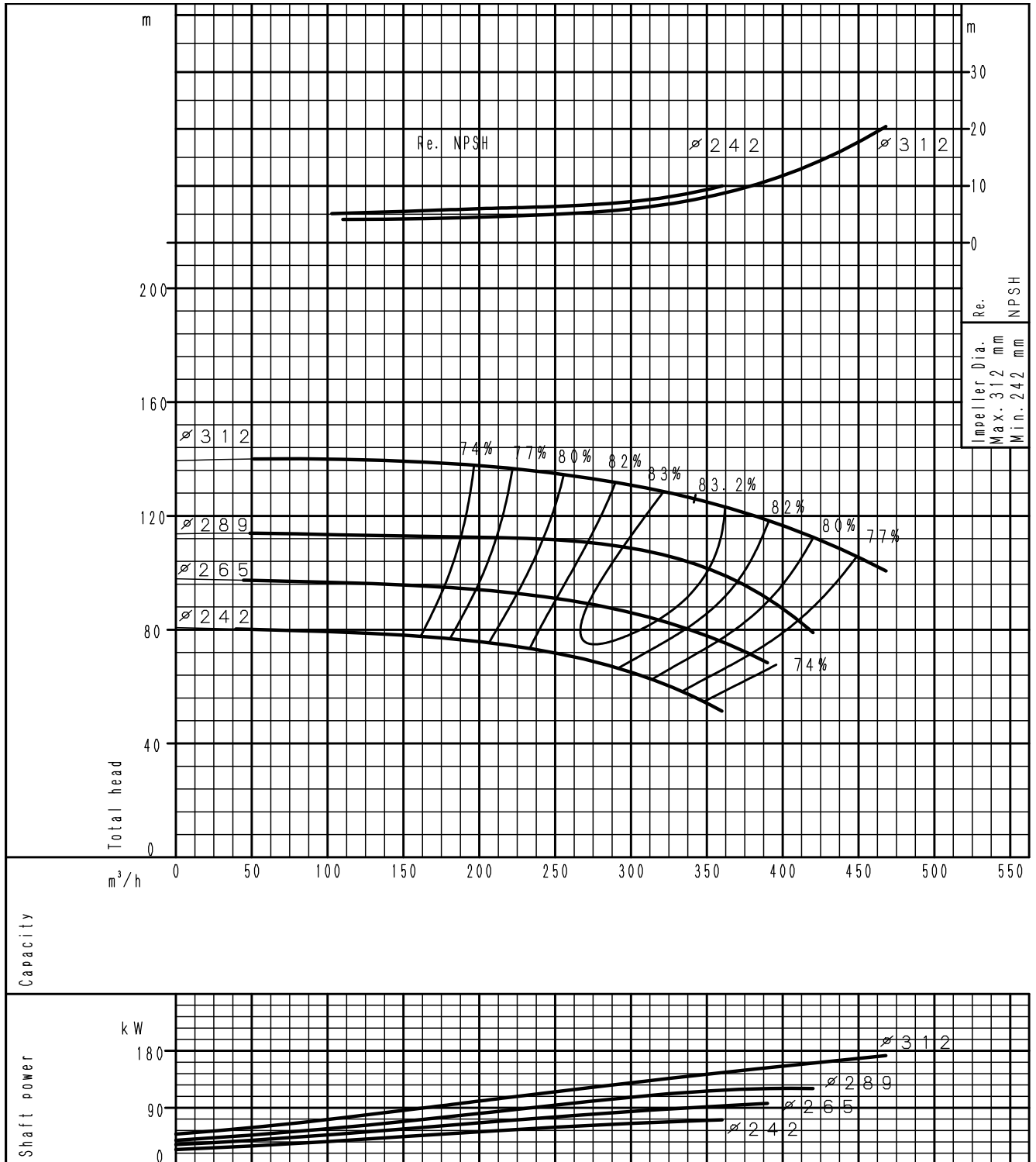

(speed 2900<sup>-1</sup>) According to ISO 9906 grade 3B

### PERFORMANCE CURVE GS 125-200

2 poles

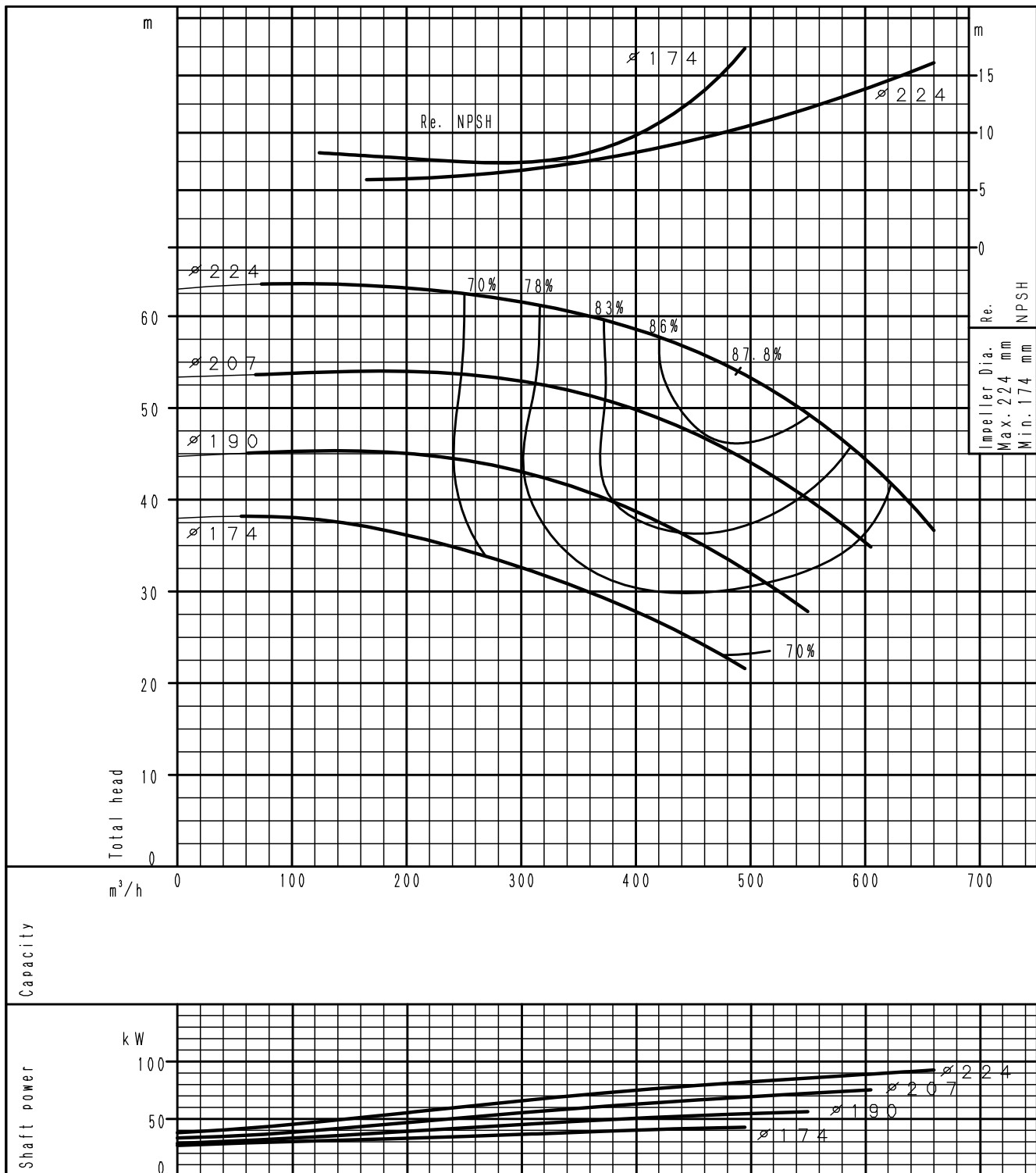

(speed 2900<sup>-1</sup>) According to ISO 9906 grade 3B

PERFORMANCE CURVE  
GS 125-250L

2 poles

PERFORMANCE CURVES

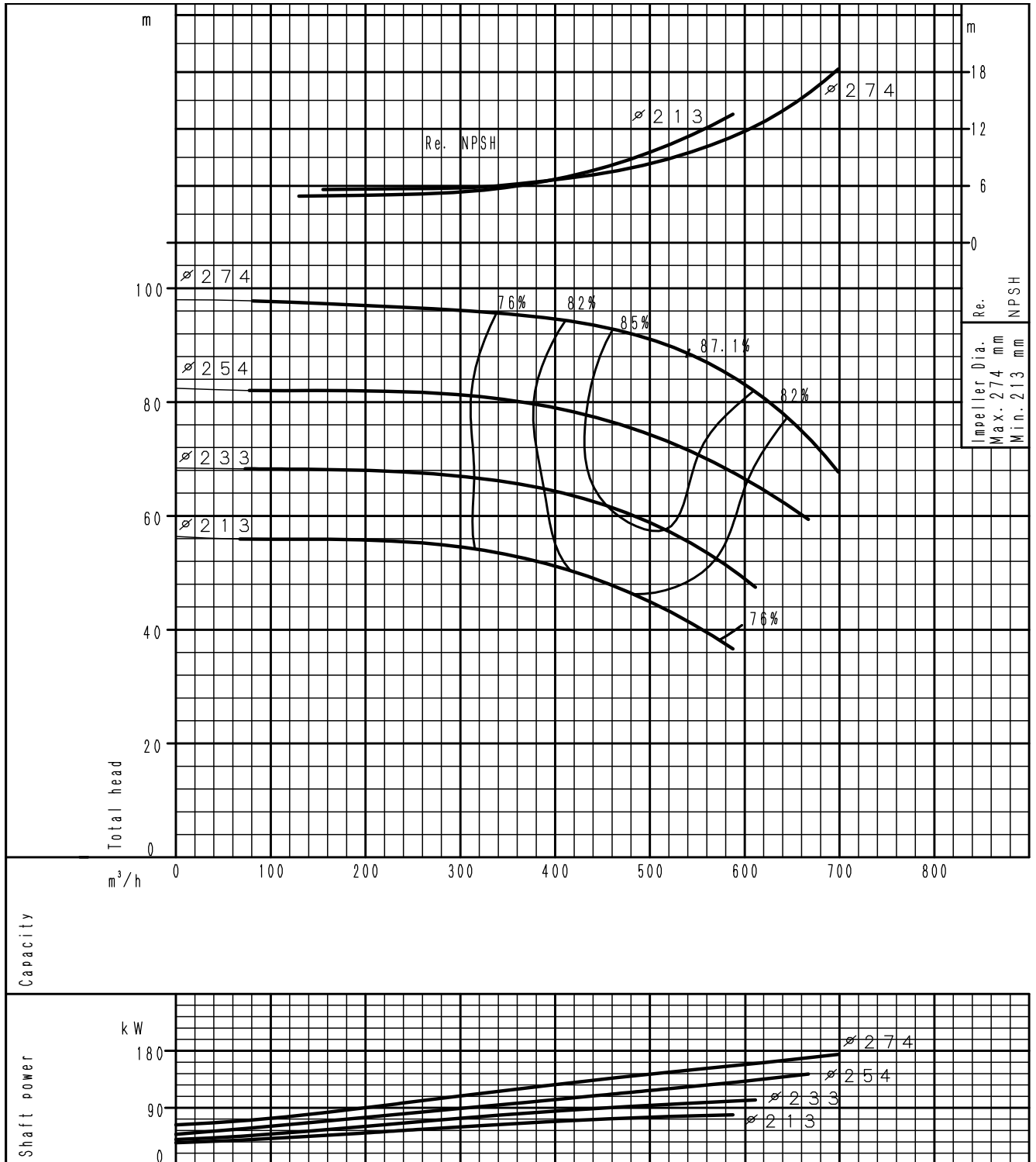

(speed 2900<sup>-1</sup>) According to ISO 9906 grade 3B



### PERFORMANCE CURVE GS 125-315

2 poles

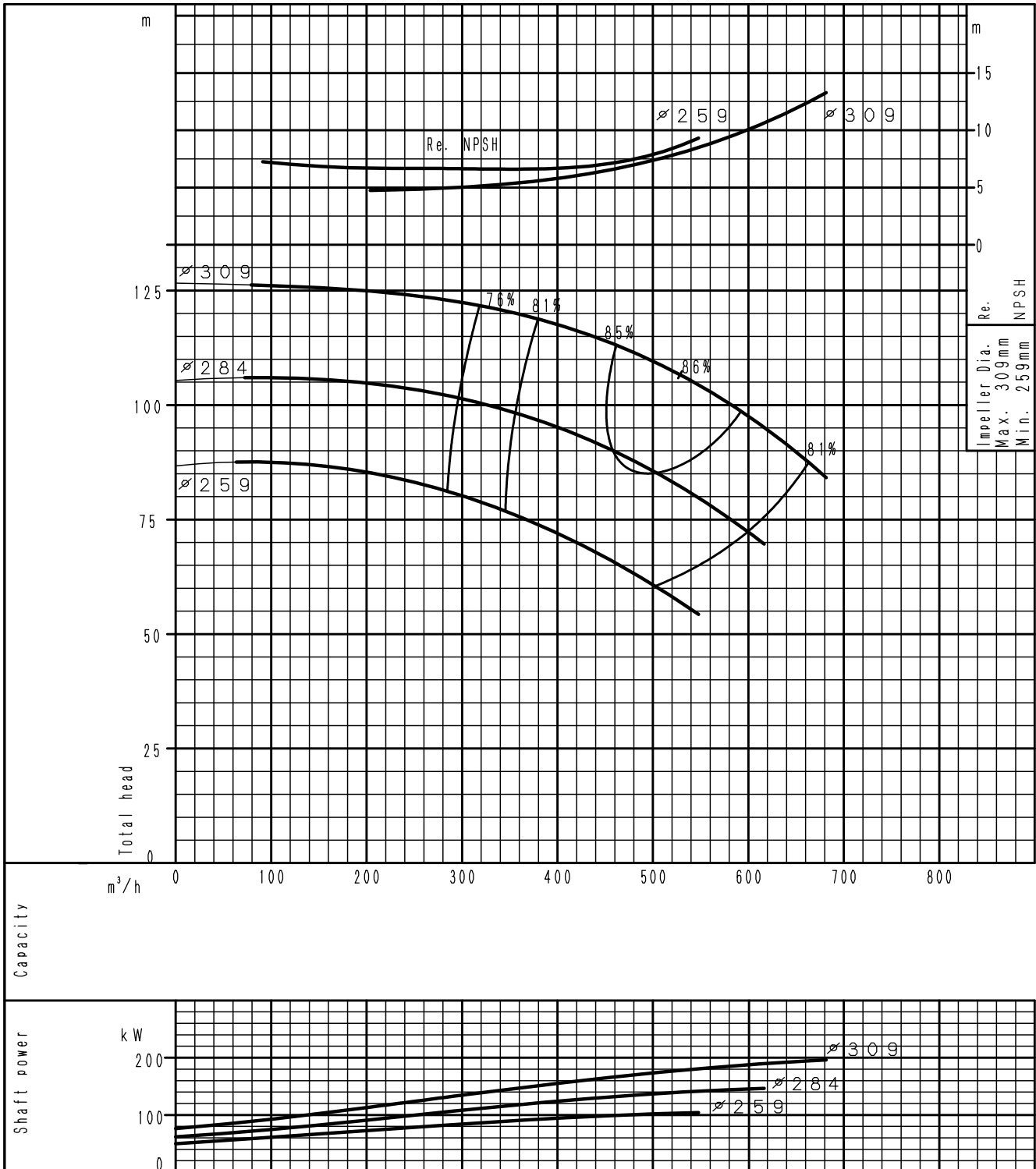

(speed 2900<sup>-1</sup>) According to ISO 9906 grade 3B

PERFORMANCE CURVE

GS 150-200

2 poles

PERFORMANCE CURVES

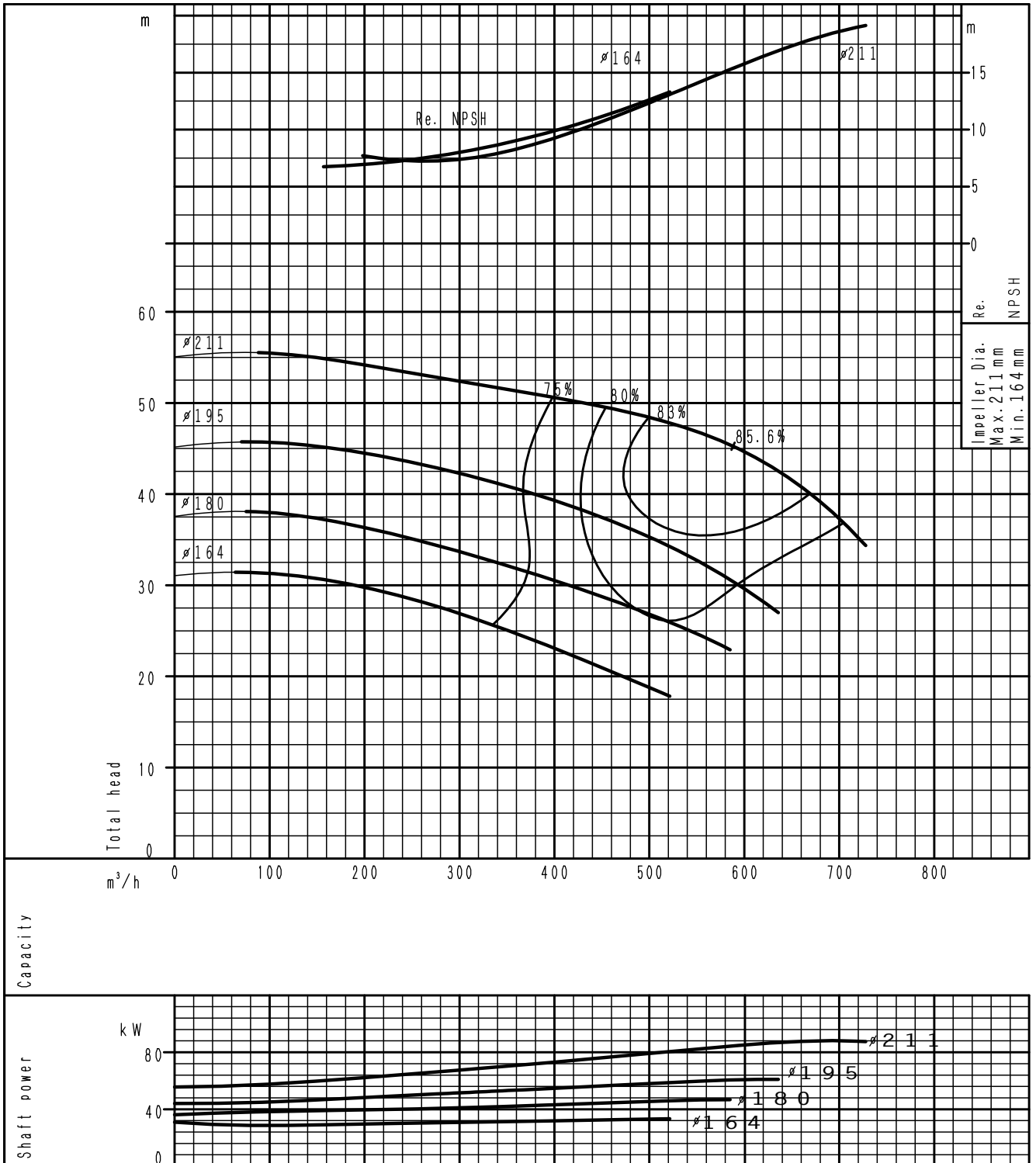

(speed 2900<sup>-1</sup>) According to ISO 9906 grade 3B

### PERFORMANCE CURVE GS 150-250

2 poles

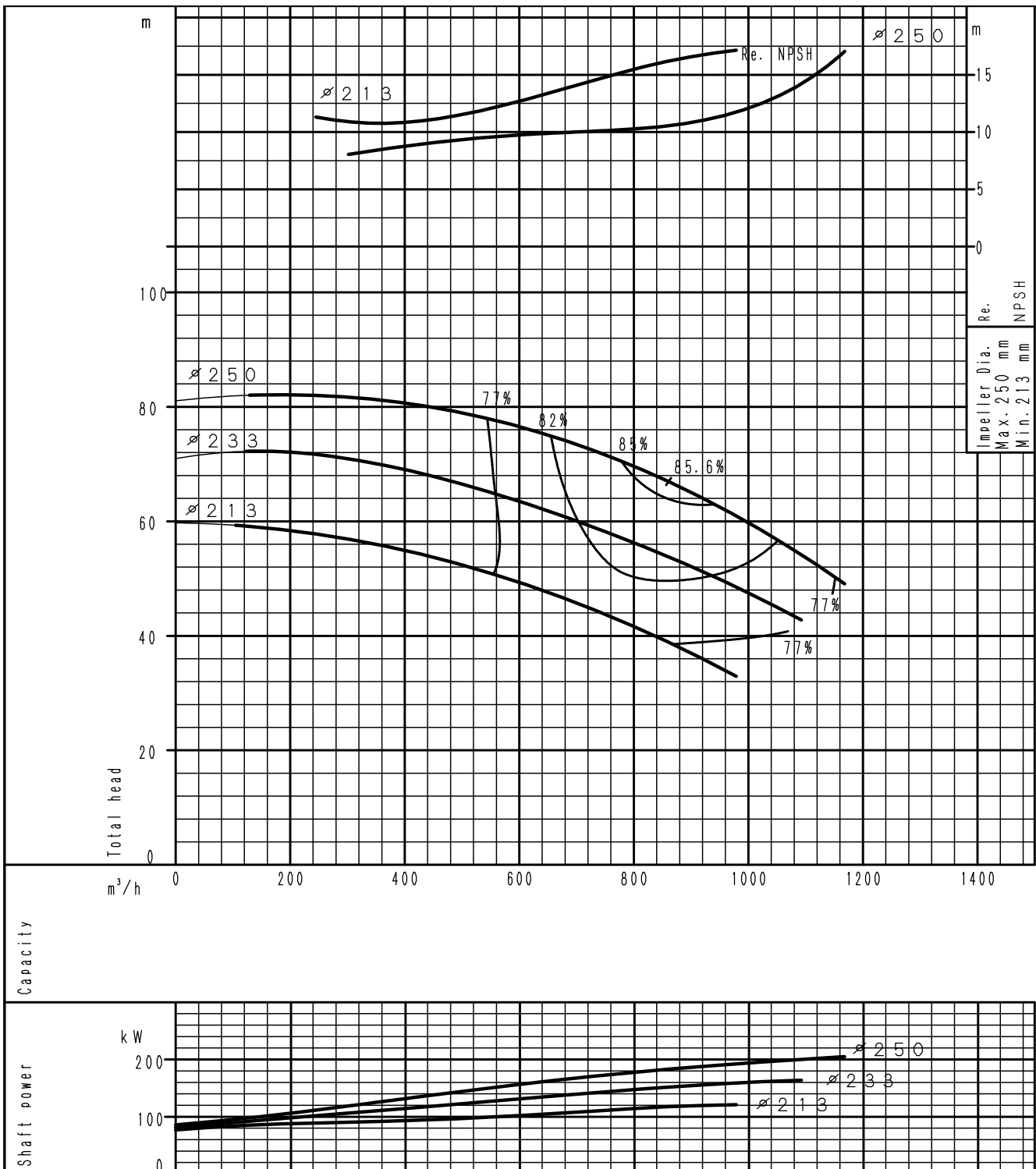

(speed 2900<sup>-1</sup>) According to ISO 9906 grade 3B

PERFORMANCE CURVE  
GS 32-125.1

4 poles

PERFORMANCE CURVES

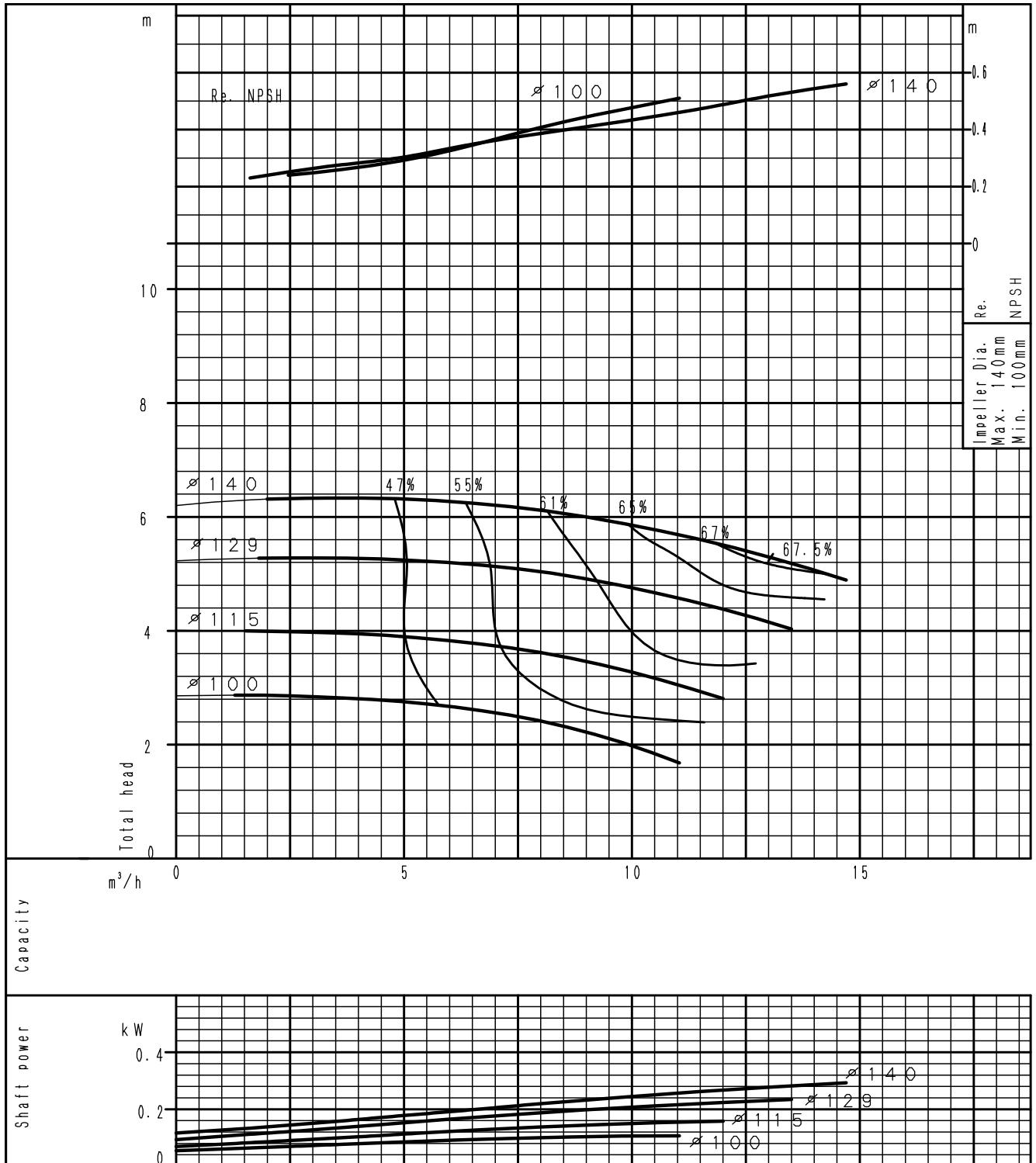

(speed 1450<sup>-1</sup>) According to ISO 9906 grade 3B

### PERFORMANCE CURVE GS 32-160.1

4 poles

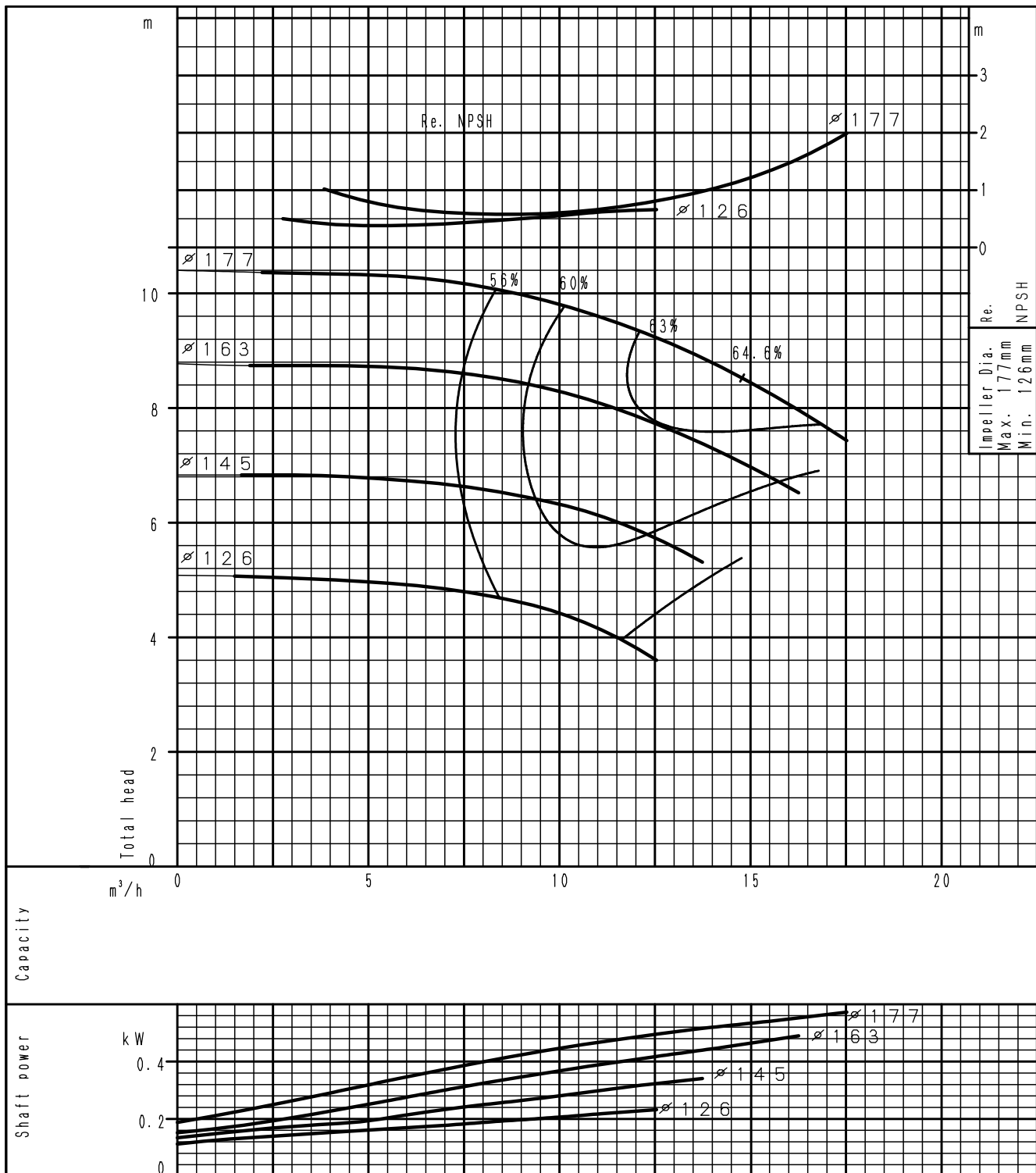

(speed 1450<sup>-1</sup>) According to ISO 9906 grade 3B

PERFORMANCE CURVE  
GS 32-200.1

4 poles

PERFORMANCE CURVES

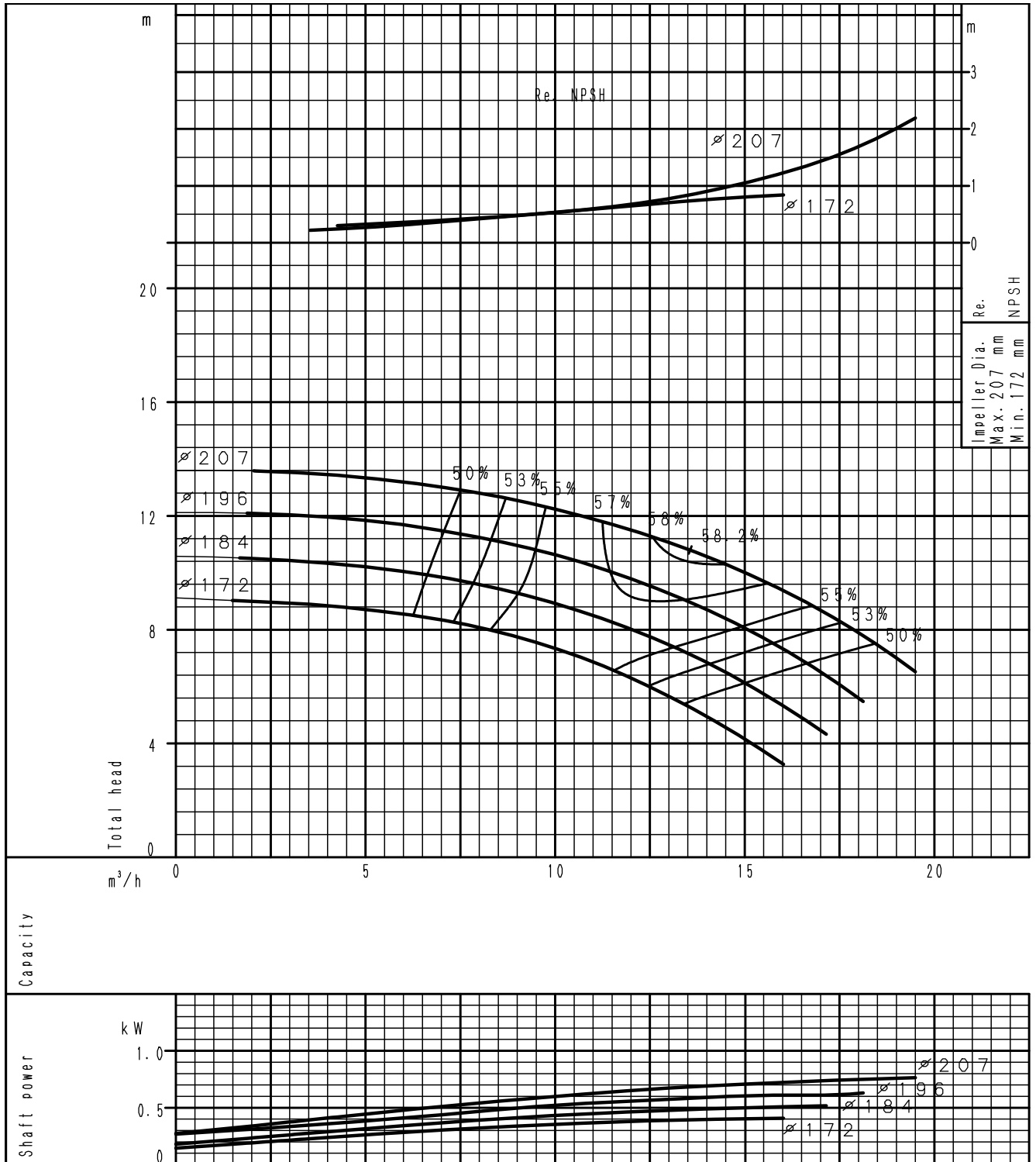

(speed 1450<sup>-1</sup>) According to ISO 9906 grade 3B

### PERFORMANCE CURVE GS 32-125

4 poles

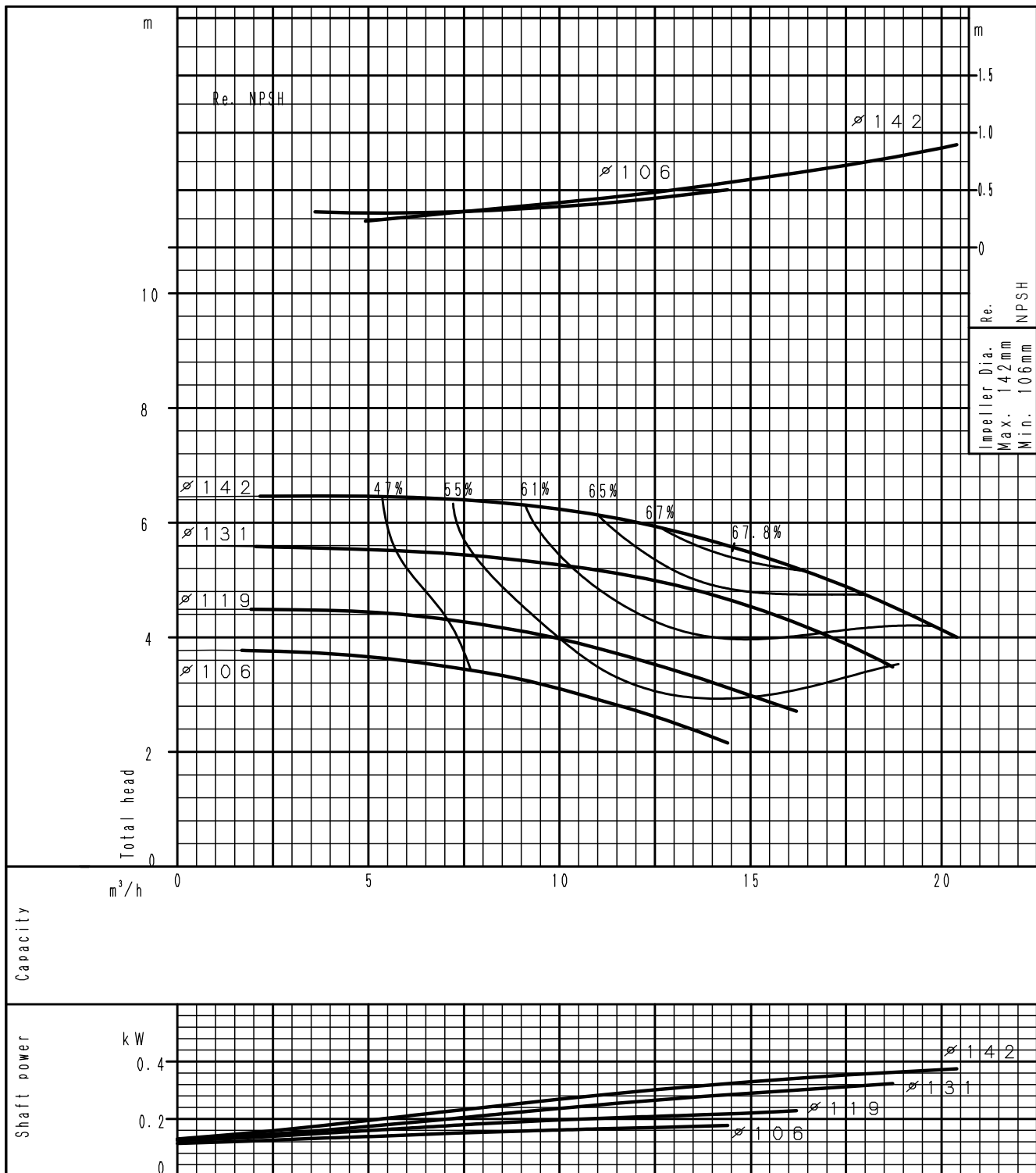

(speed 1450<sup>-1</sup>) According to ISO 9906 grade 3B

PERFORMANCE CURVE

GS 32-160

4 poles

PERFORMANCE CURVES

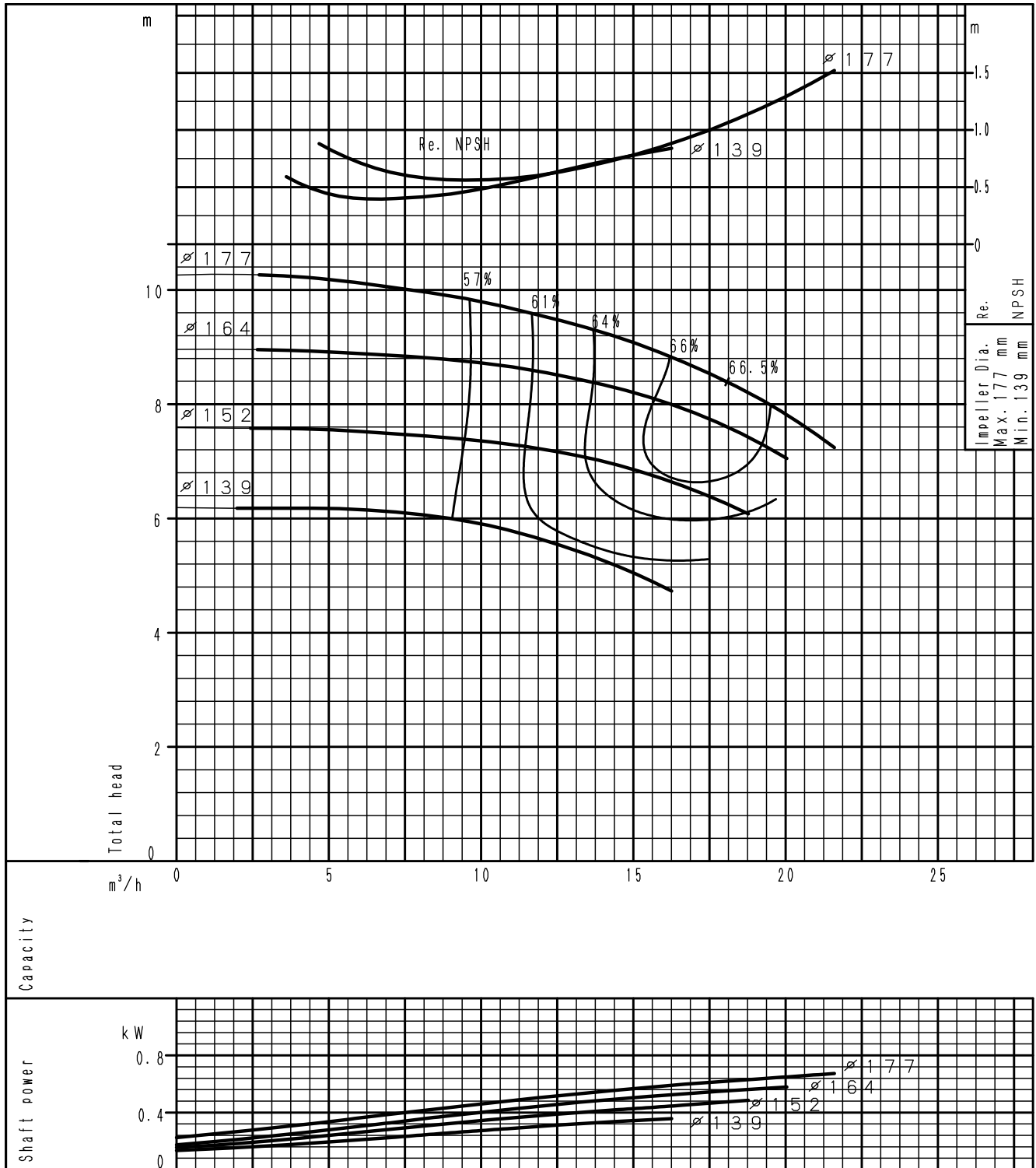

(speed 1450<sup>-1</sup>) According to ISO 9906 grade 3B



### PERFORMANCE CURVE GS 32-200

4 poles

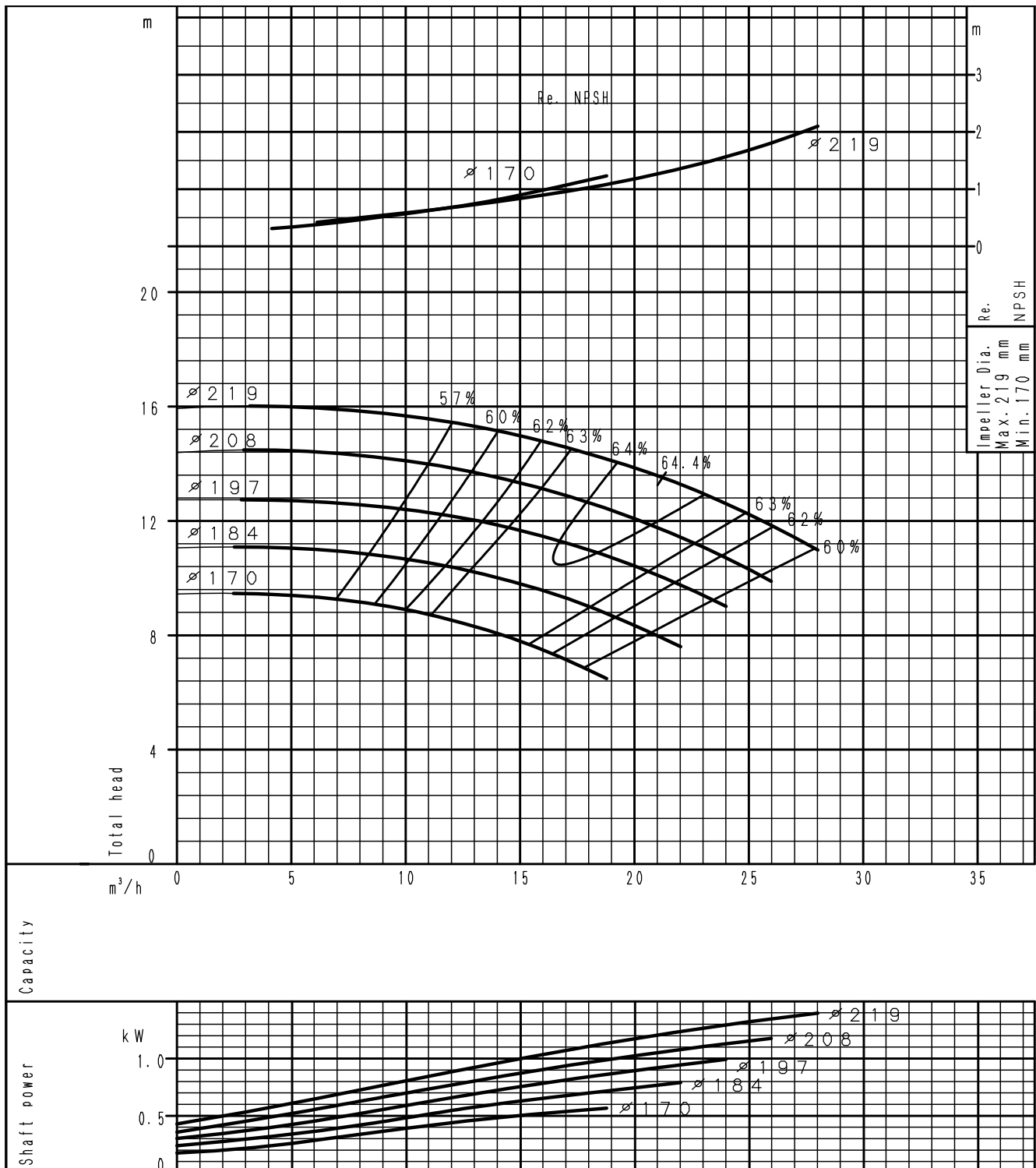

(speed 1450<sup>-1</sup>) According to ISO 9906 grade 3B

PERFORMANCE CURVE  
GS 32-250

4 poles

PERFORMANCE CURVES

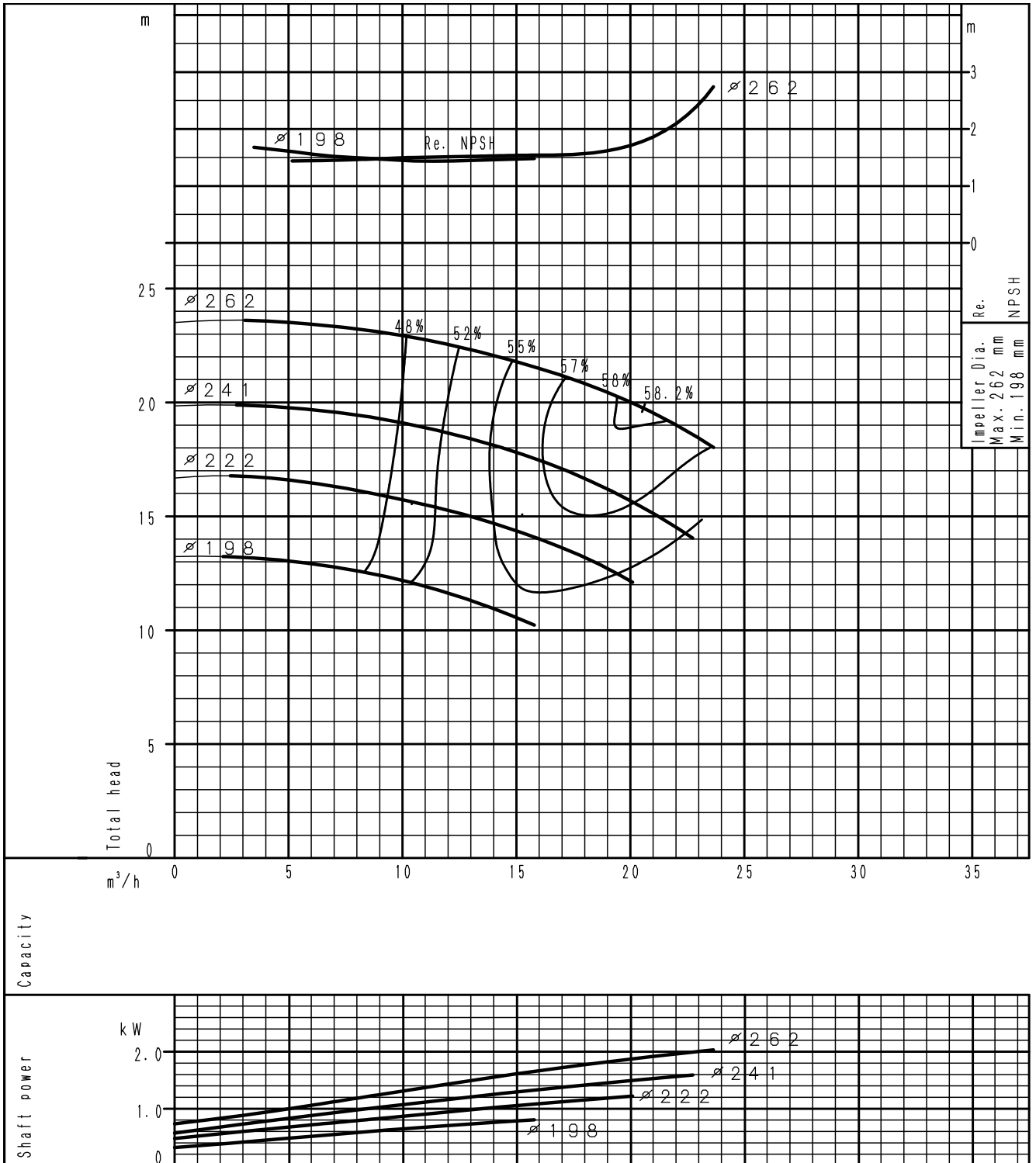

(speed 1450<sup>-1</sup>) According to ISO 9906 grade 3B

### PERFORMANCE CURVE GS 40-125

4 poles

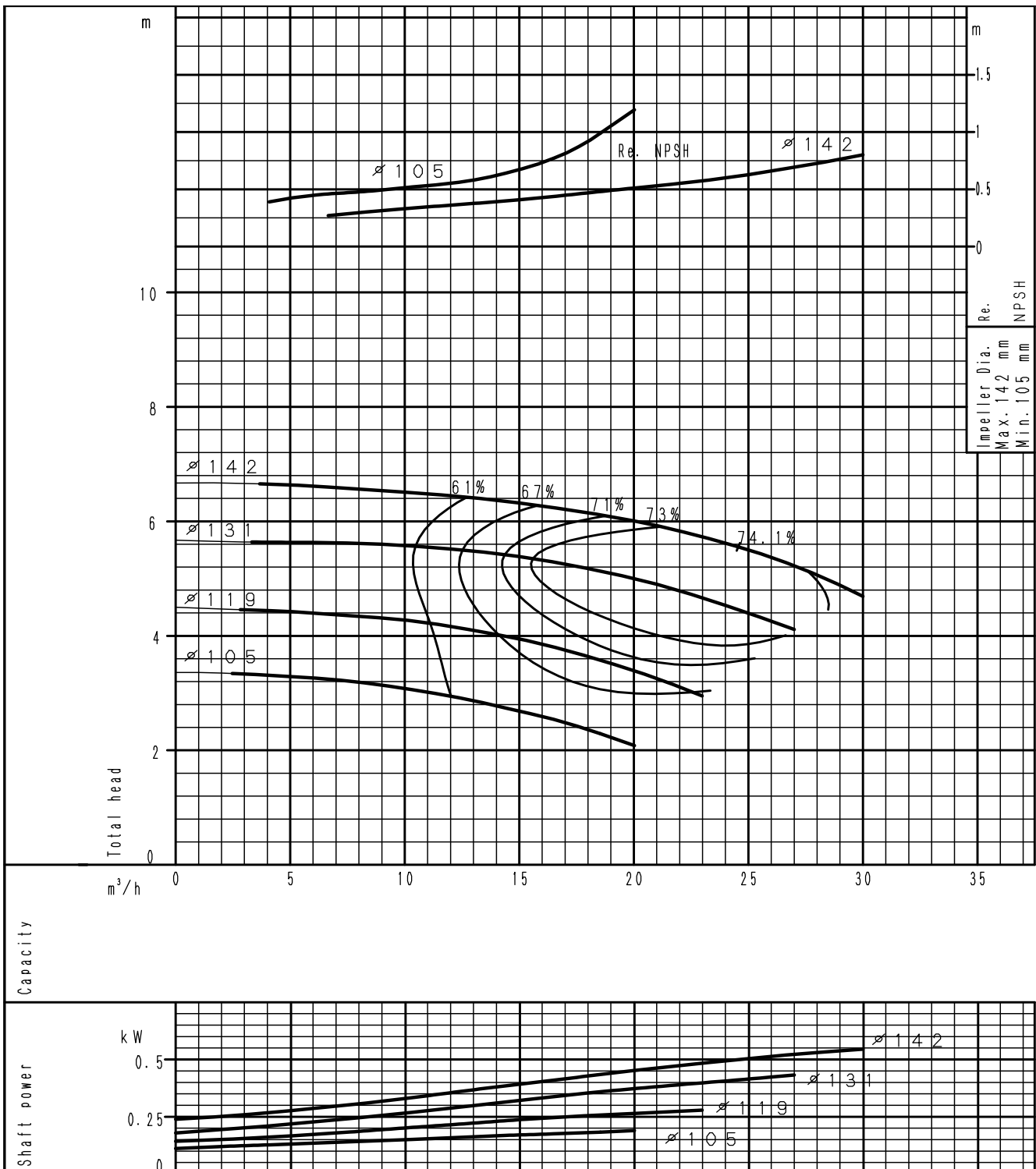

(speed 1450<sup>-1</sup>) According to ISO 9906 grade 3B

PERFORMANCE CURVE  
GS 40-160

4 poles

PERFORMANCE CURVES

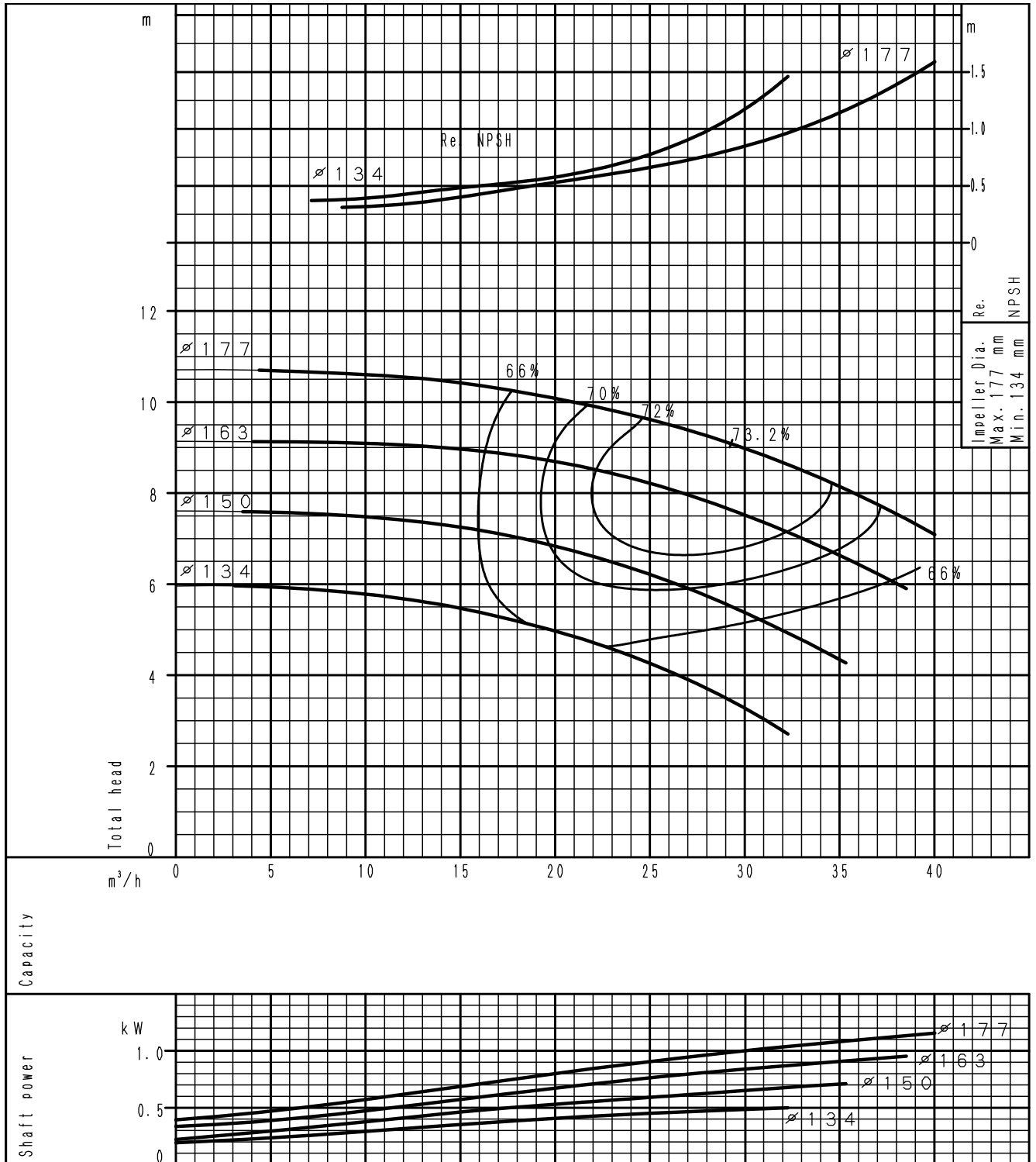

(speed 1450<sup>-1</sup>) According to ISO 9906 grade 3B

### PERFORMANCE CURVE GS 40-200

4 poles

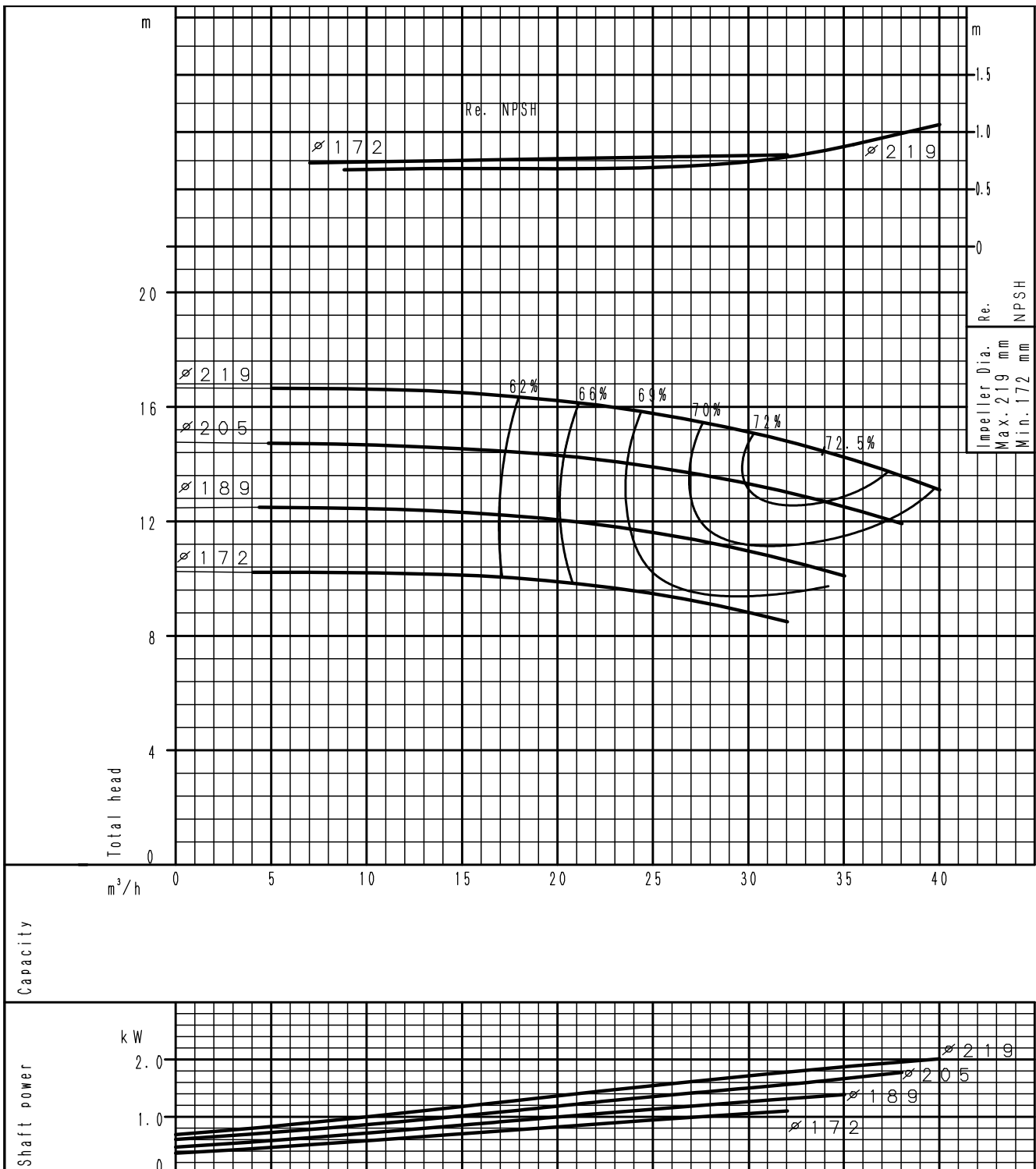

(speed 1450<sup>-1</sup>) According to ISO 9906 grade 3B

PERFORMANCE CURVE

GS 40-250

4 poles

PERFORMANCE CURVES

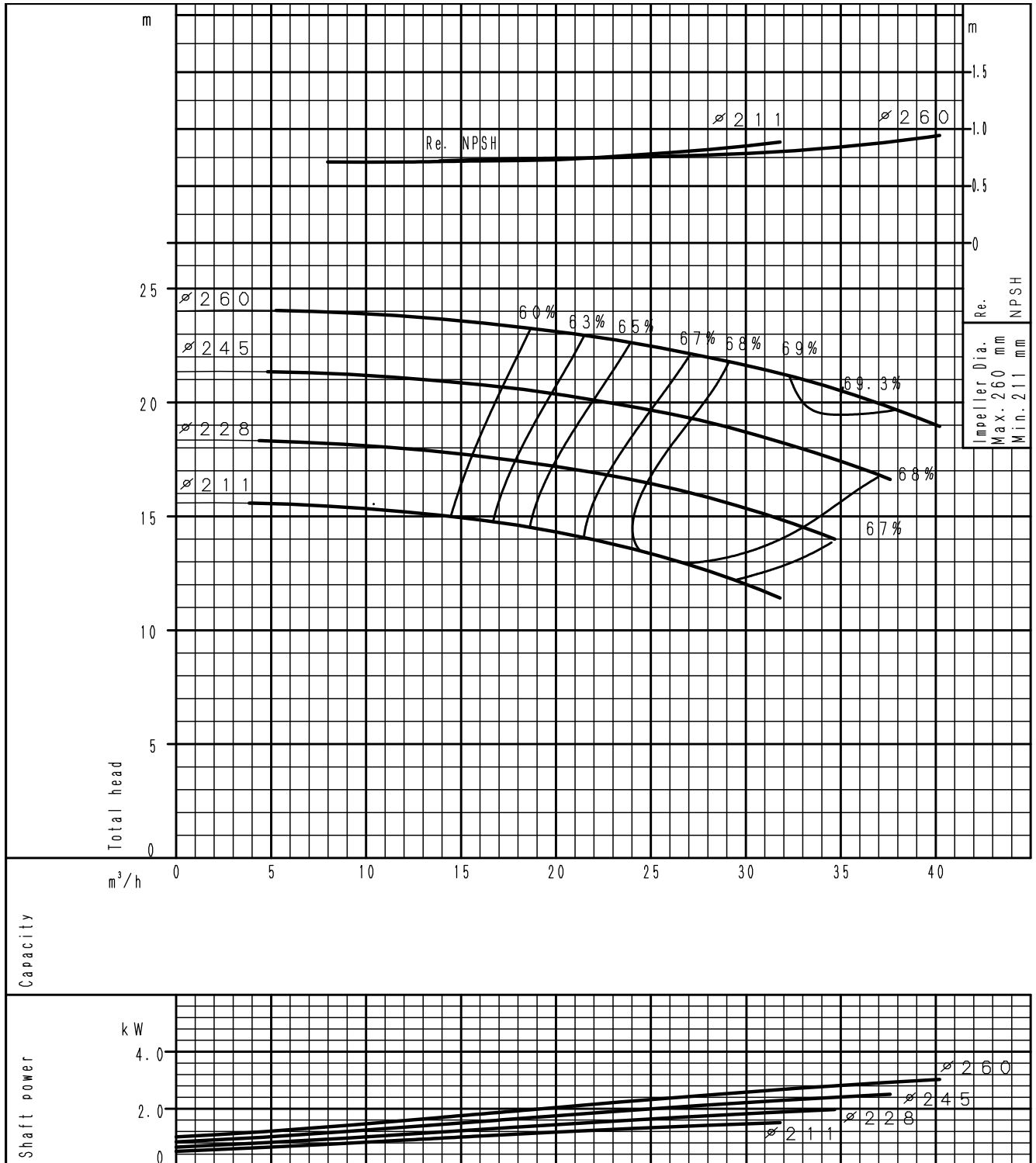

(speed 1450<sup>-1</sup>) According to ISO 9906 grade 3B

### PERFORMANCE CURVE GS 40-315

4 poles

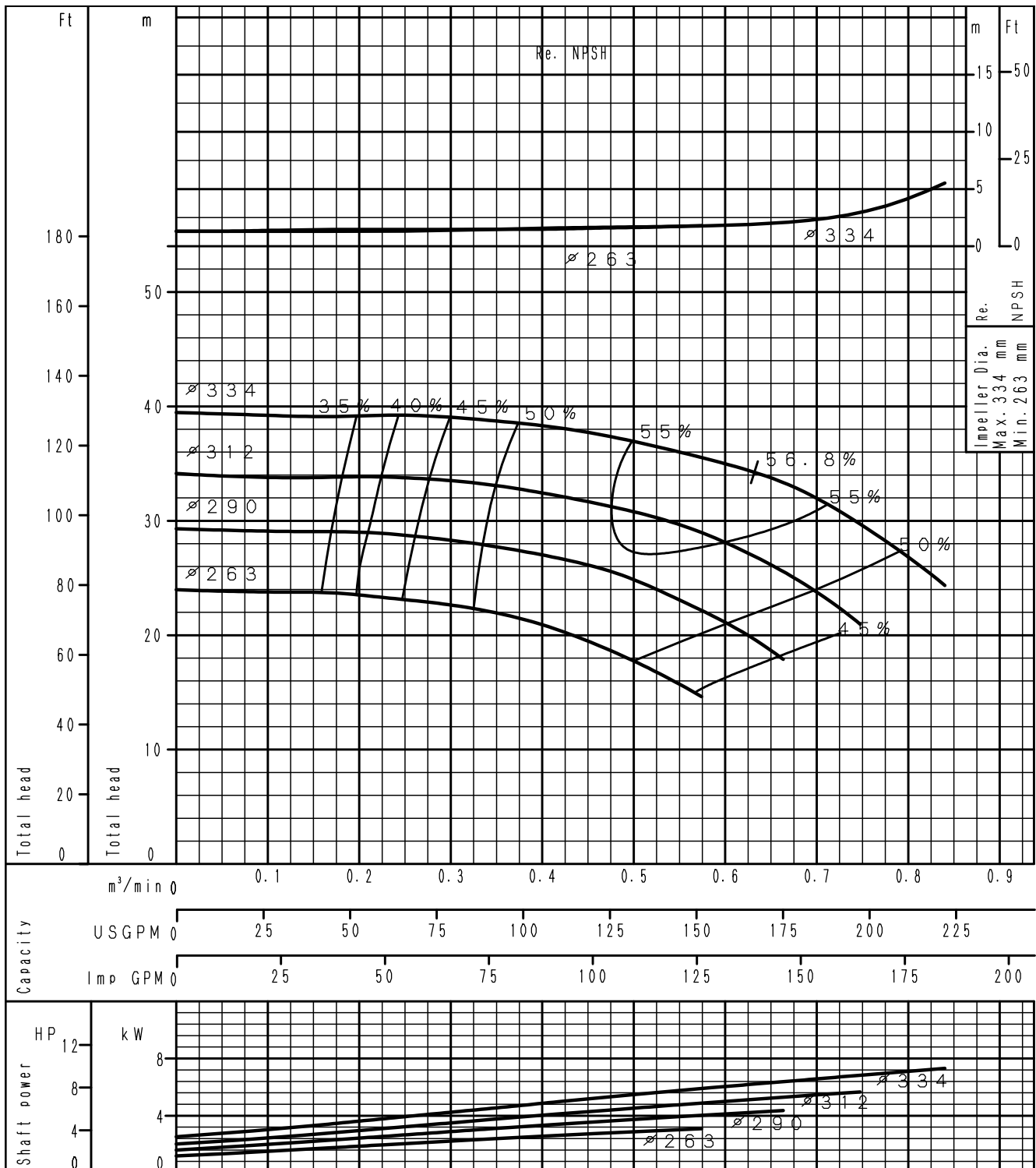

(speed 1450<sup>-1</sup>) According to ISO 9906 grade 3B

PERFORMANCE CURVE  
GS 50-125

4 poles

PERFORMANCE CURVES

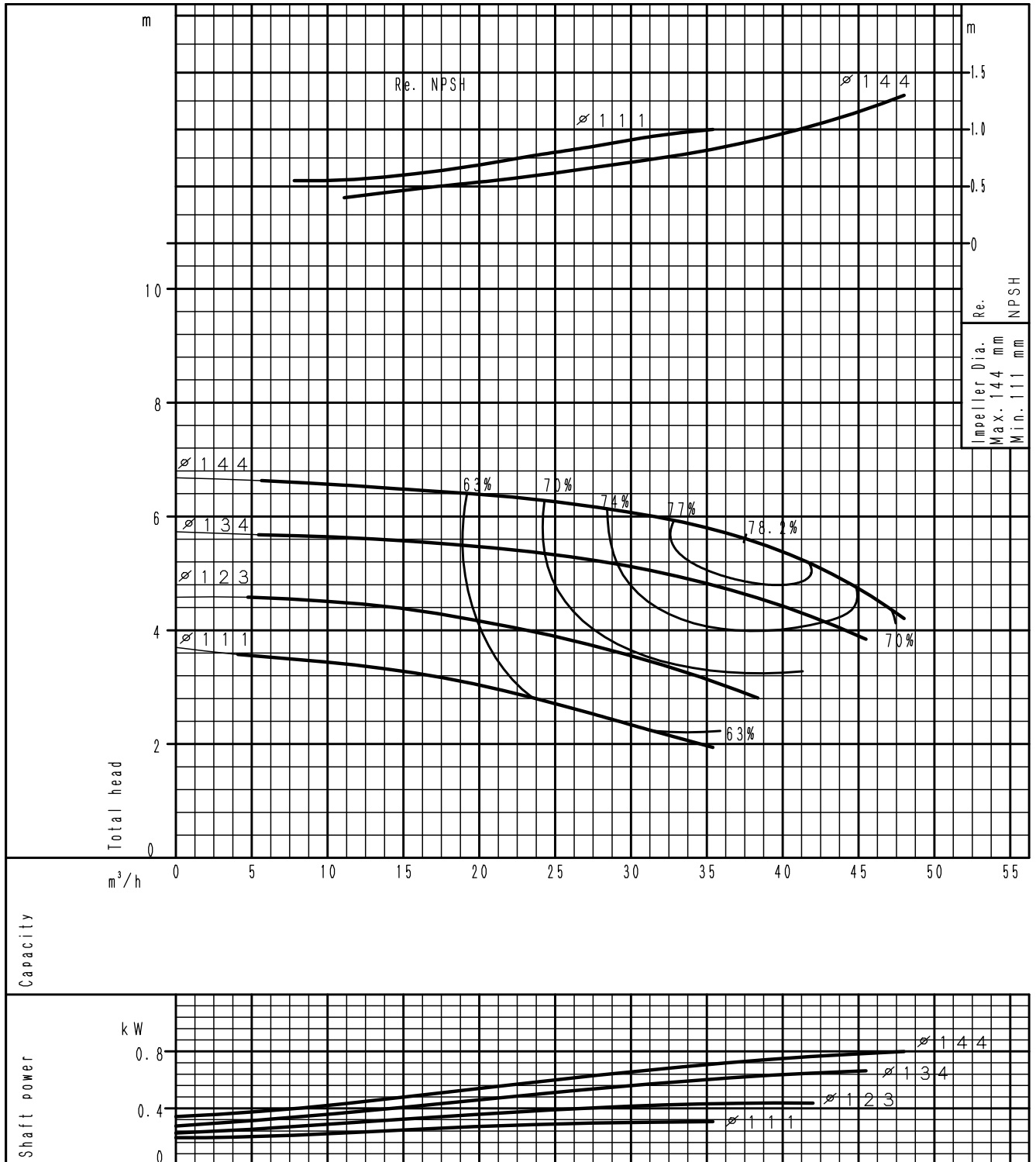

(speed 1450<sup>-1</sup>) According to ISO 9906 grade 3B



### PERFORMANCE CURVE GS 50-160

4 poles

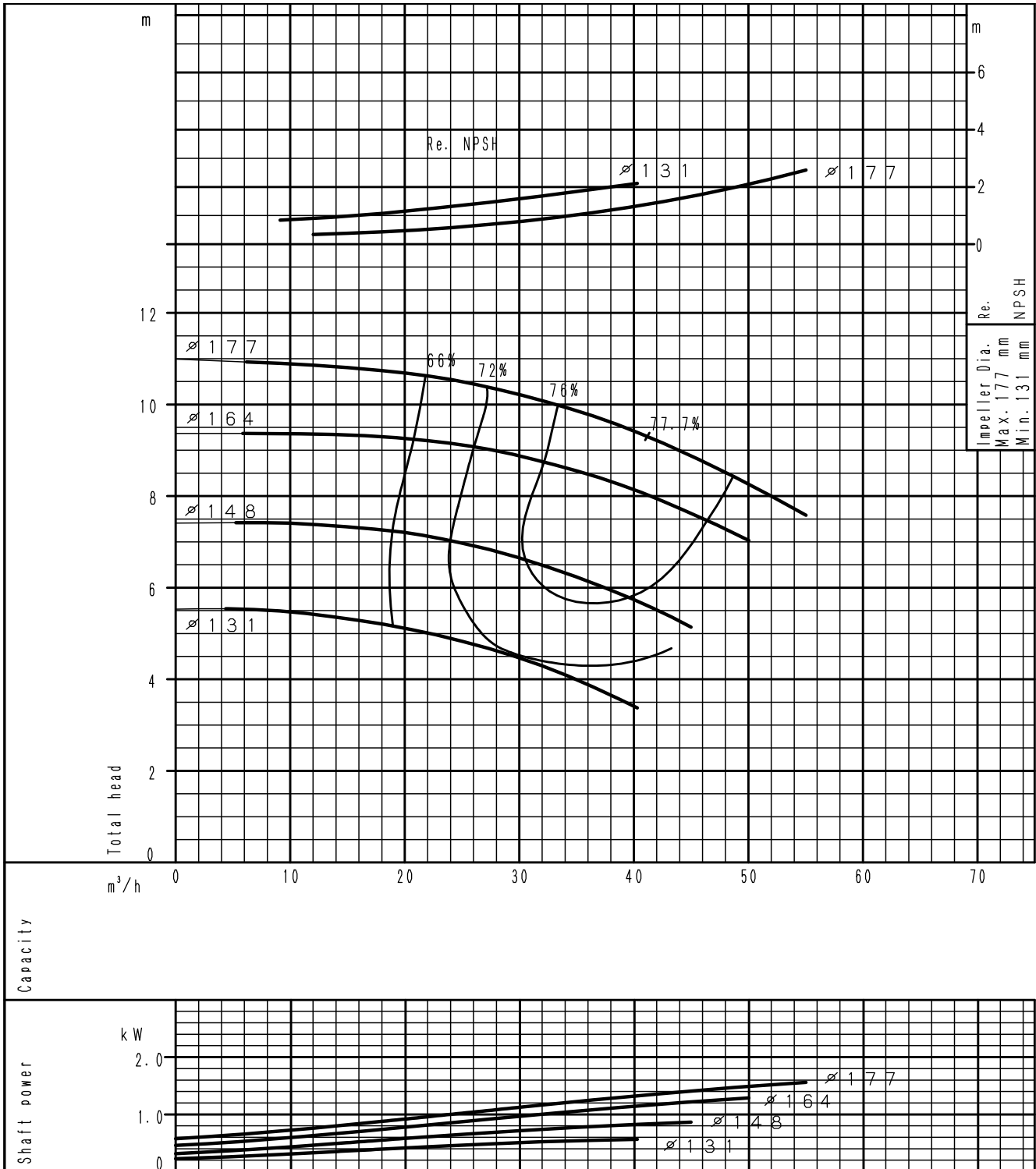

(speed 1450<sup>-1</sup>) According to ISO 9906 grade 3B

PERFORMANCE CURVE  
GS 50-200

4 poles

PERFORMANCE CURVES

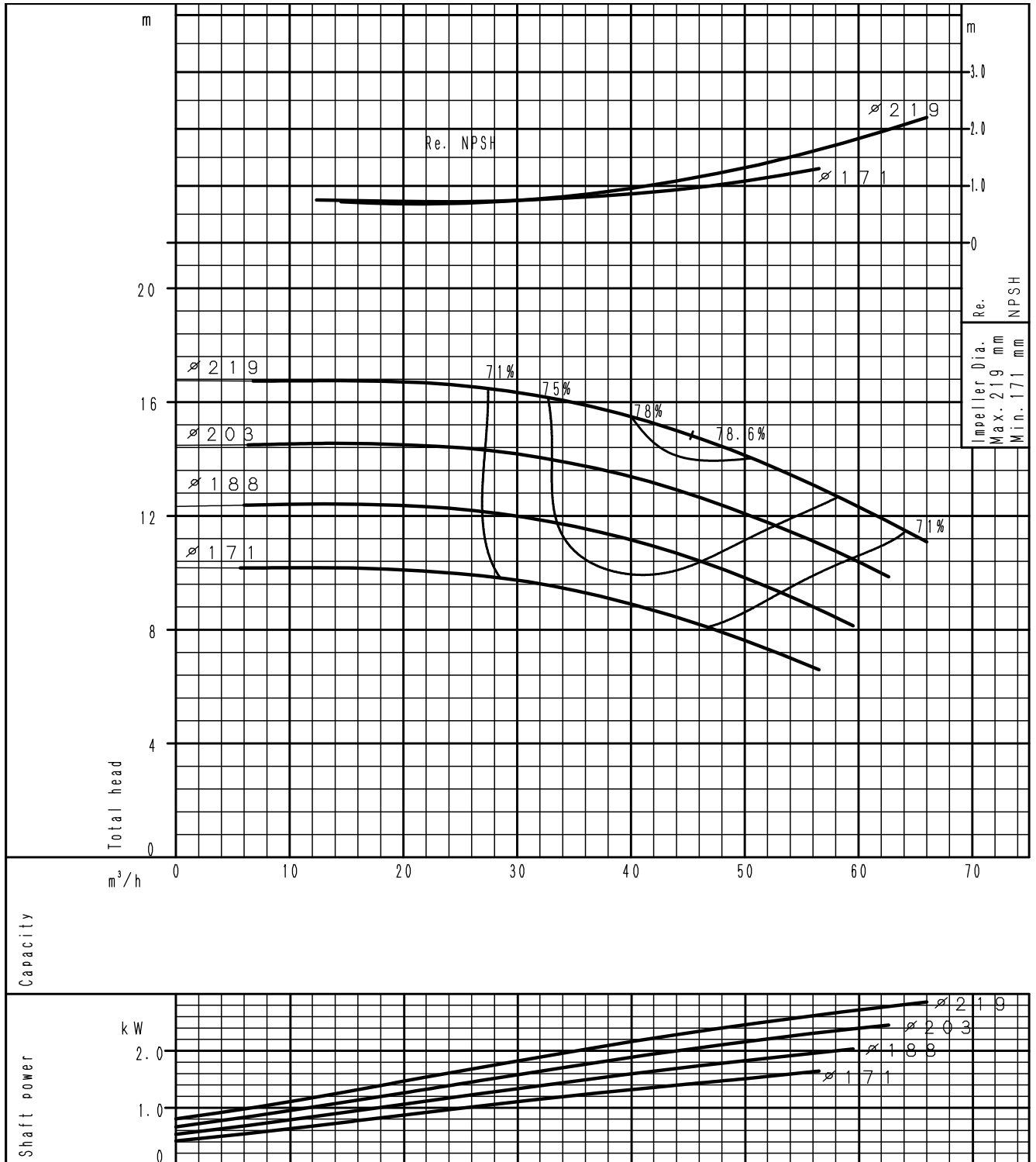

(speed 1450<sup>-1</sup>) According to ISO 9906 grade 3B

### PERFORMANCE CURVE GS 50-250

4 poles

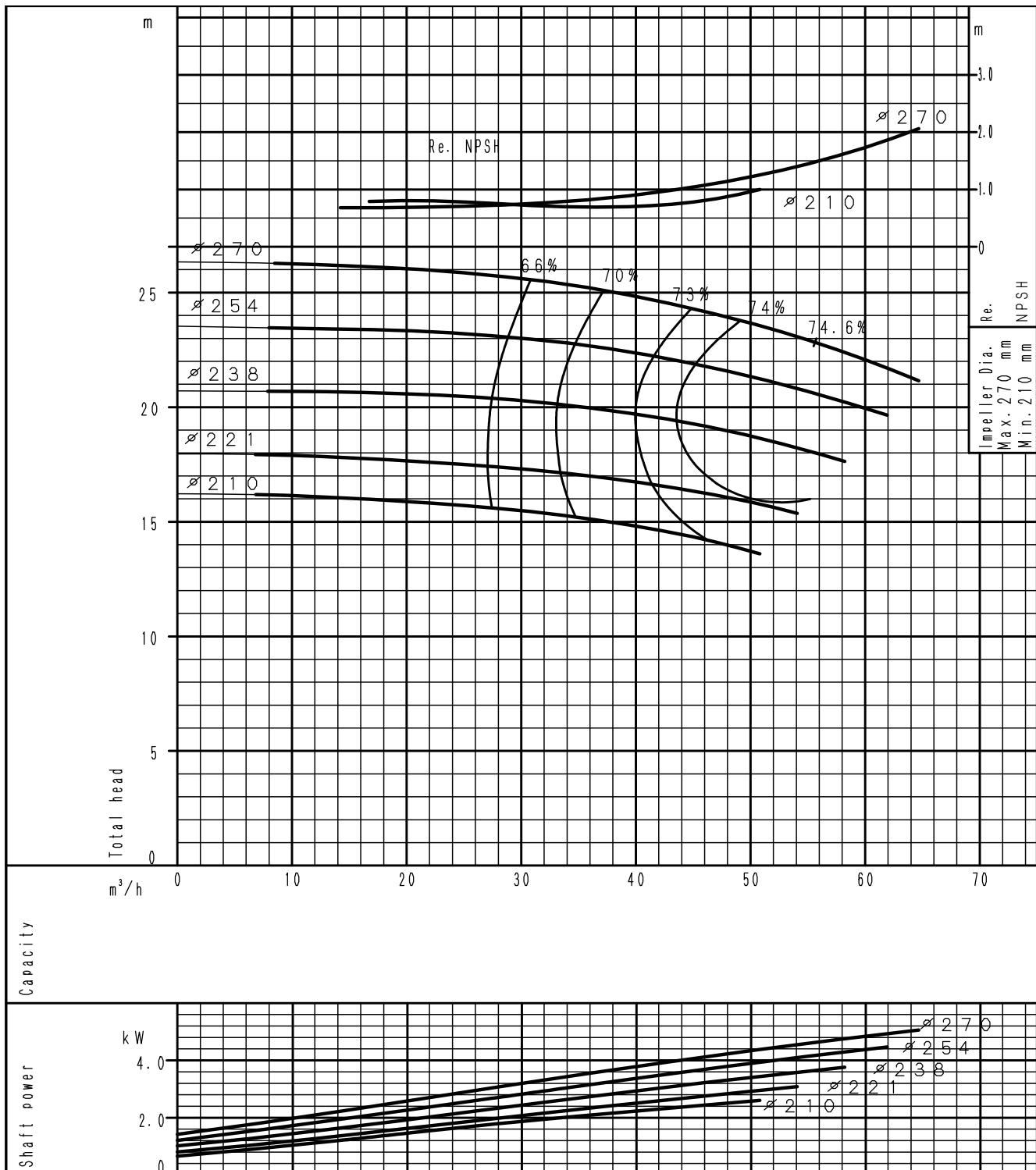

(speed 1450<sup>-1</sup>) According to ISO 9906 grade 3B

PERFORMANCE CURVE  
GS 50-315

4 poles

PERFORMANCE CURVES

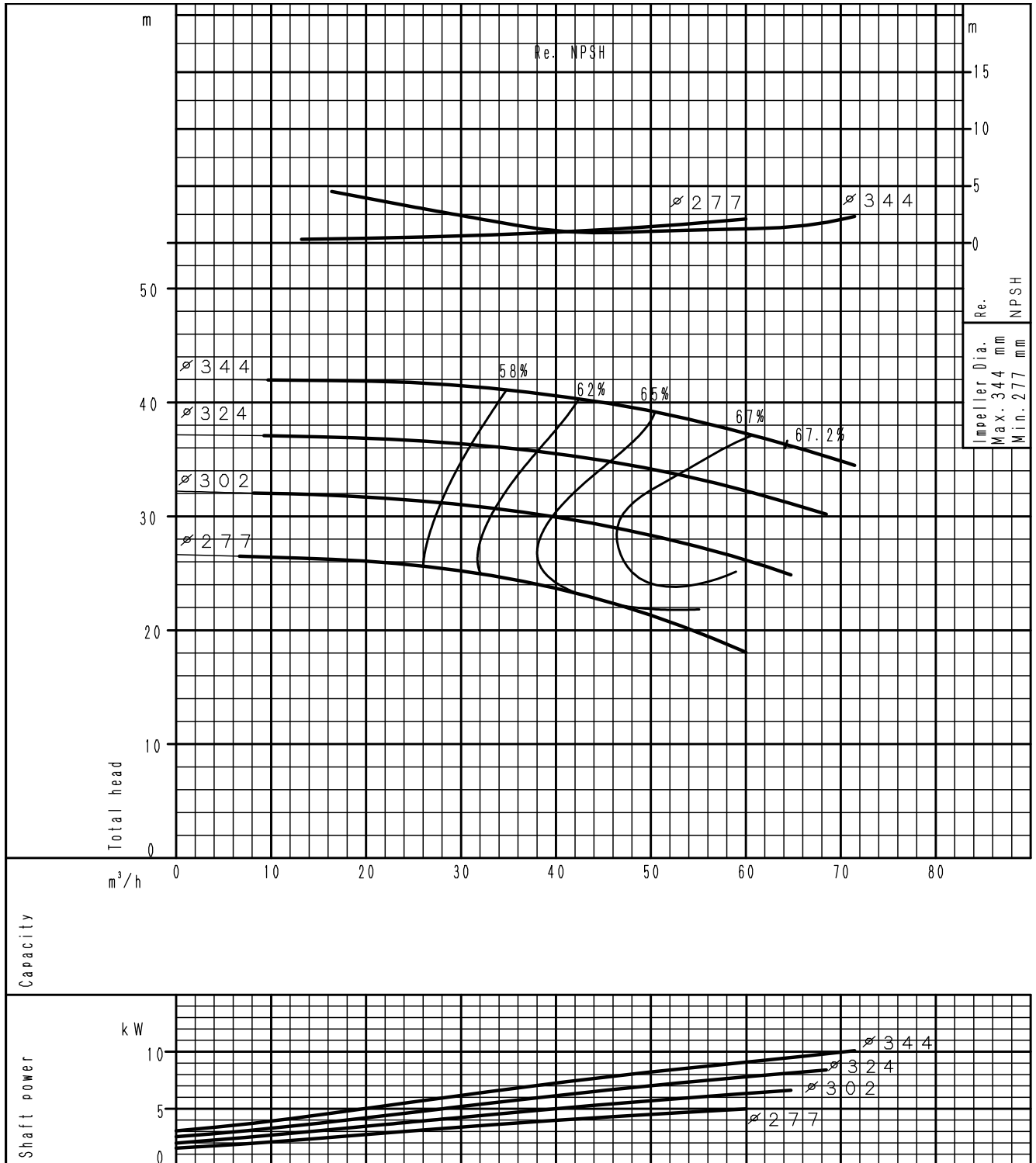

(speed 1450<sup>-1</sup>) According to ISO 9906 grade 3B

### PERFORMANCE CURVE GS 65-125

4 poles

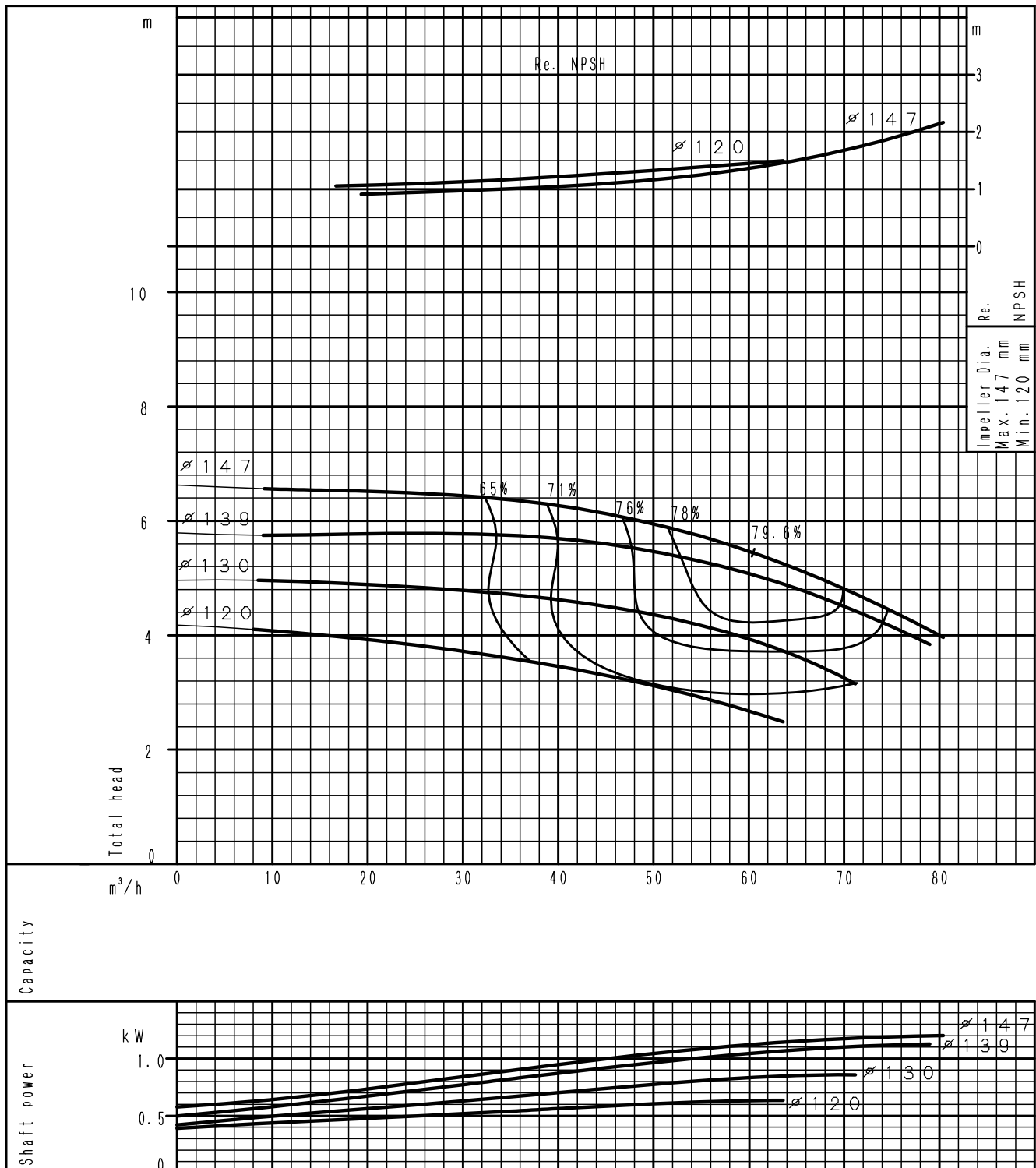

(speed 1450<sup>-1</sup>) According to ISO 9906 grade 3B

PERFORMANCE CURVE  
GS 65-160

4 poles

PERFORMANCE CURVES

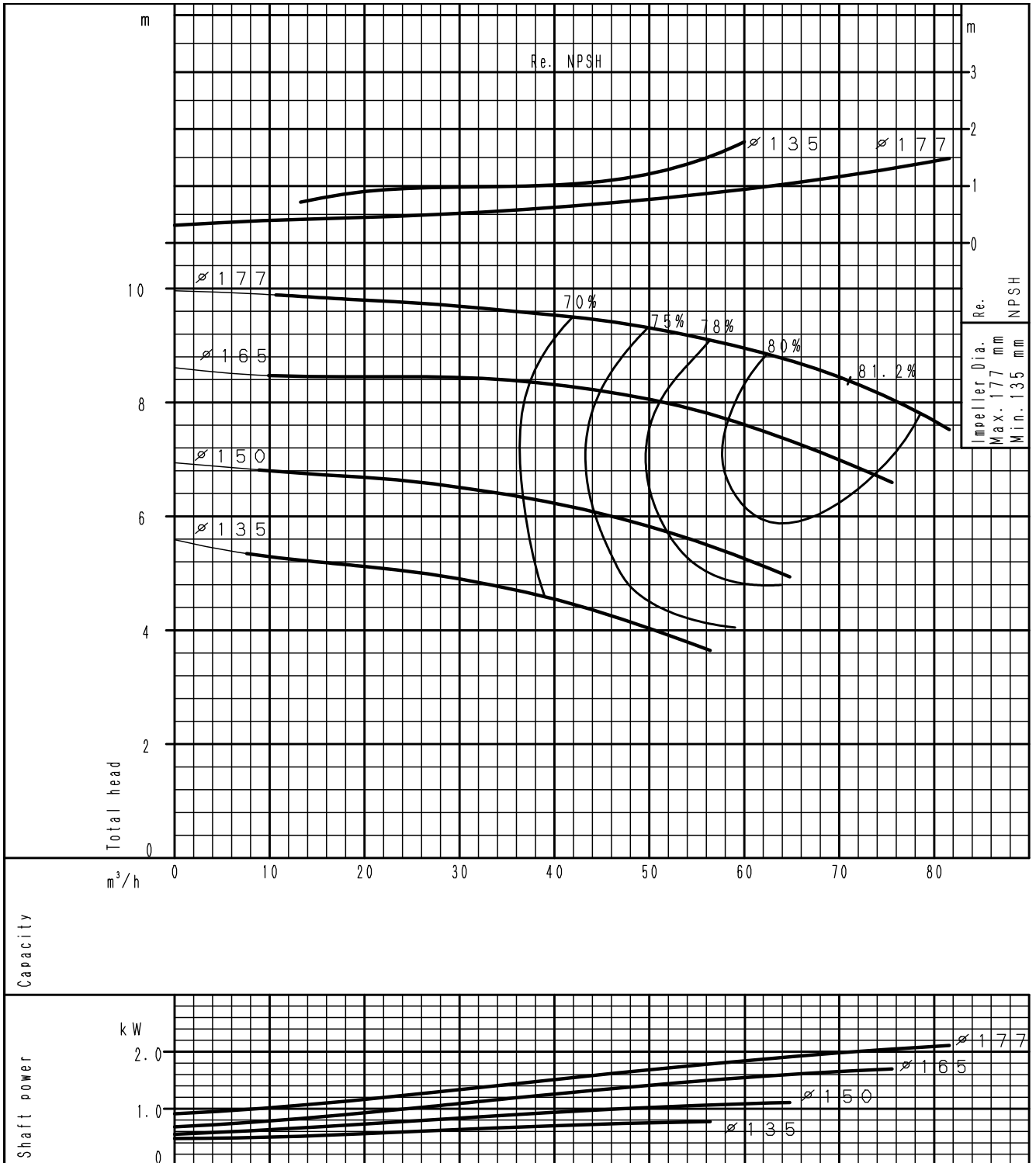

(speed 1450<sup>-1</sup>) According to ISO 9906 grade 3B

### PERFORMANCE CURVE GS 65-200

4 poles

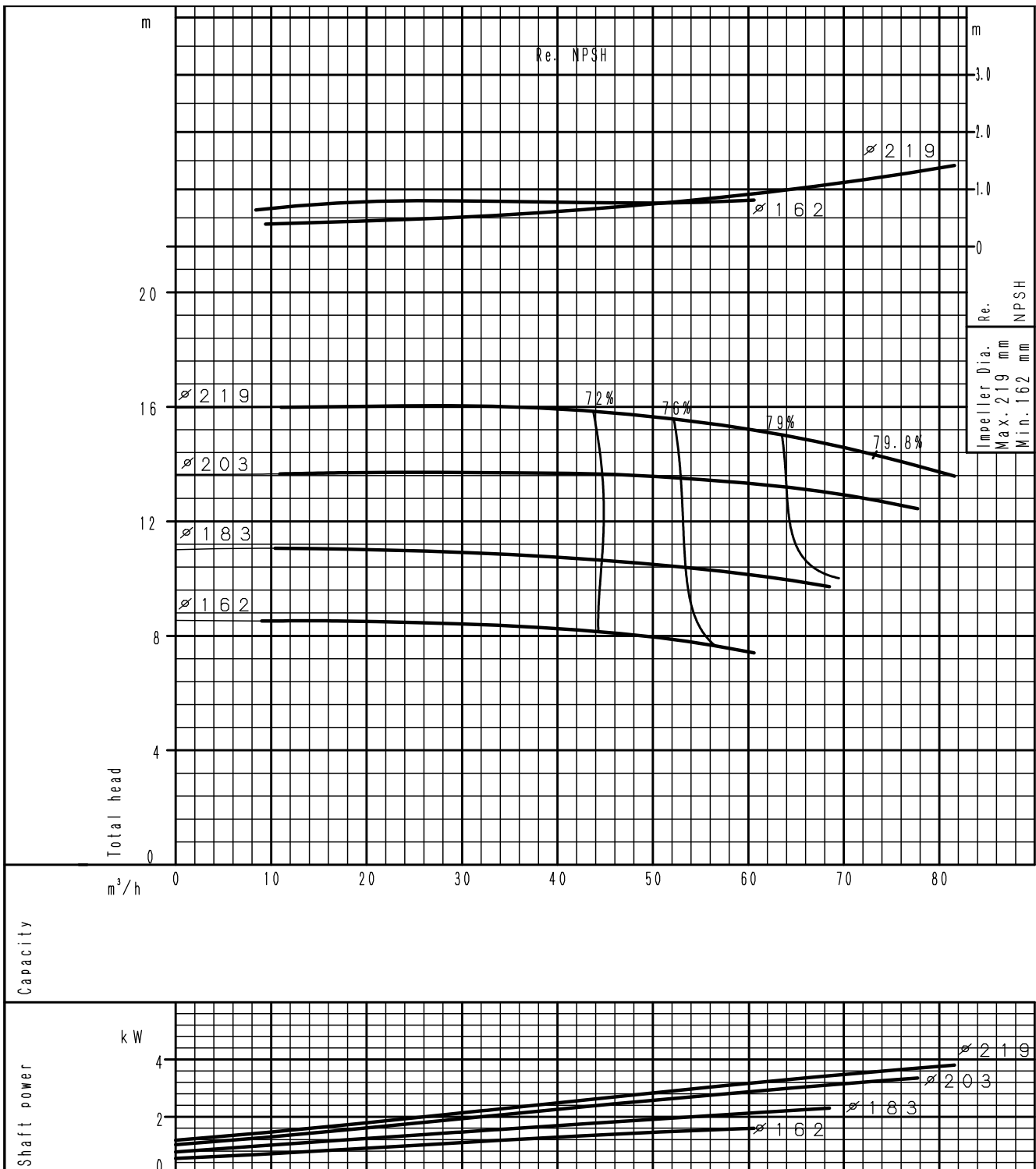

(speed 1450<sup>-1</sup>) According to ISO 9906 grade 3B

PERFORMANCE CURVE

GS 65-250

4 poles

PERFORMANCE CURVES

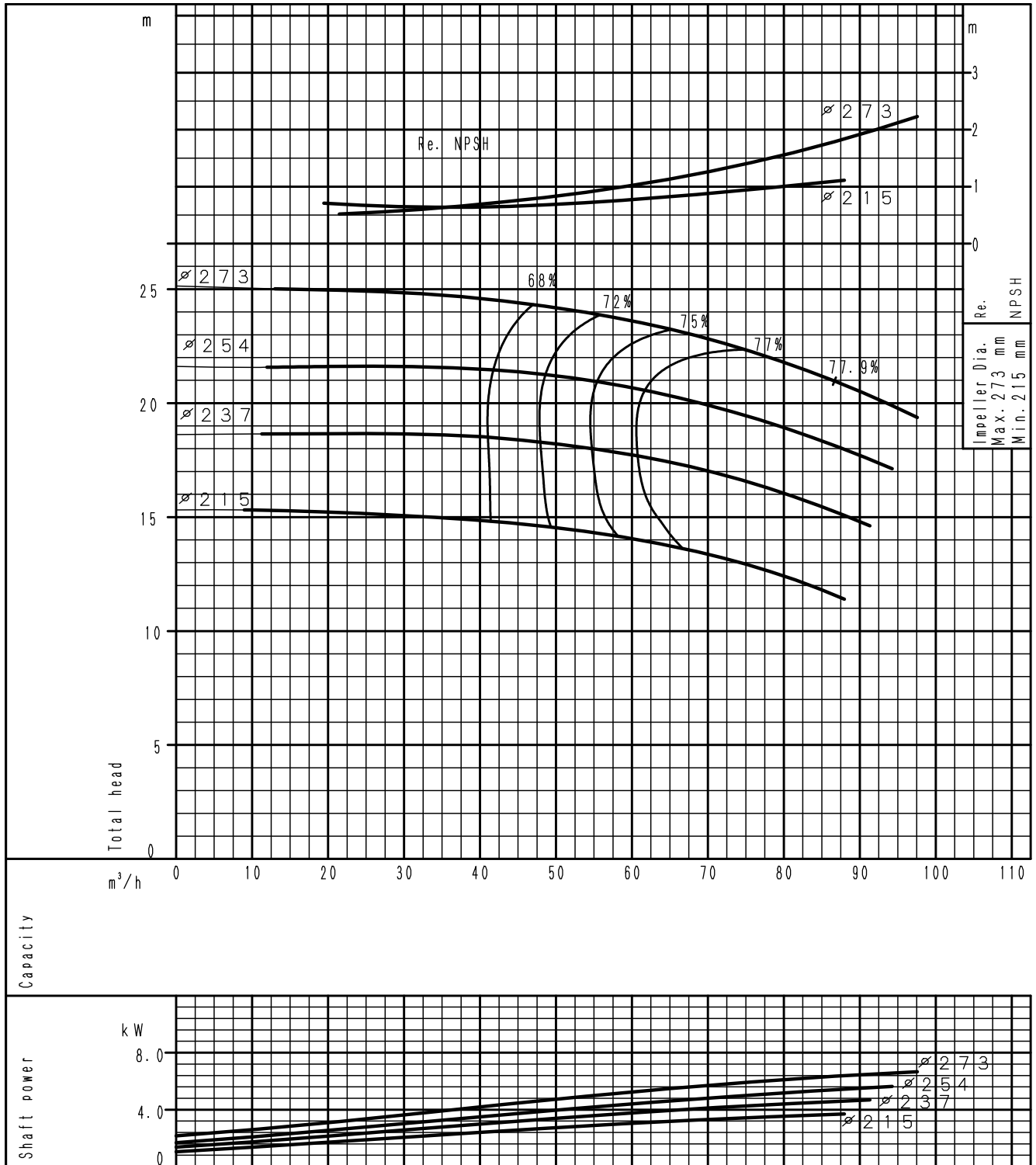

(speed 1450<sup>-1</sup>) According to ISO 9906 grade 3B



### PERFORMANCE CURVE GS 65-315

4 poles

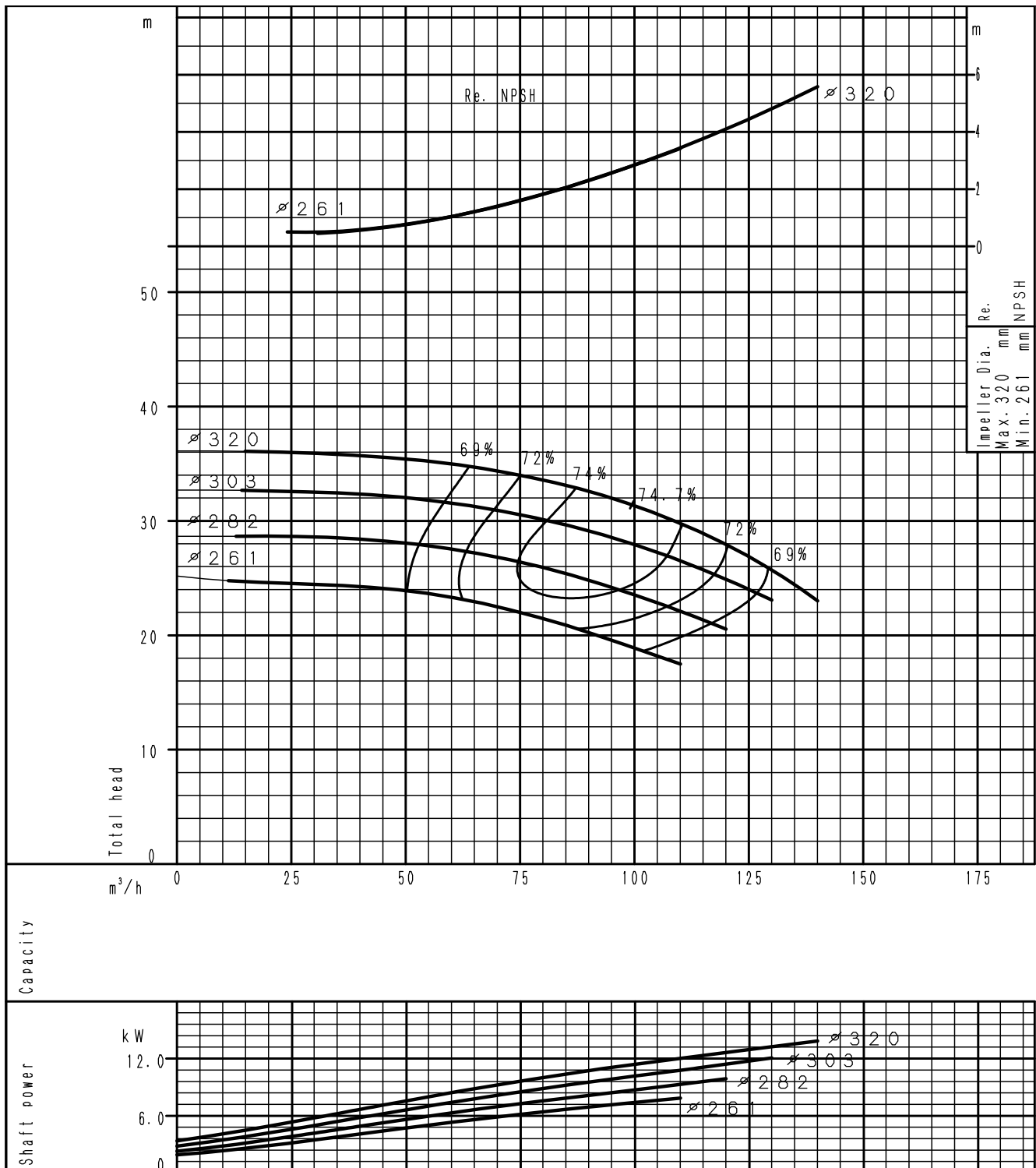

(speed 1450<sup>-1</sup>) According to ISO 9906 grade 3B

PERFORMANCE CURVE  
GS 80-160

4 poles

PERFORMANCE CURVES

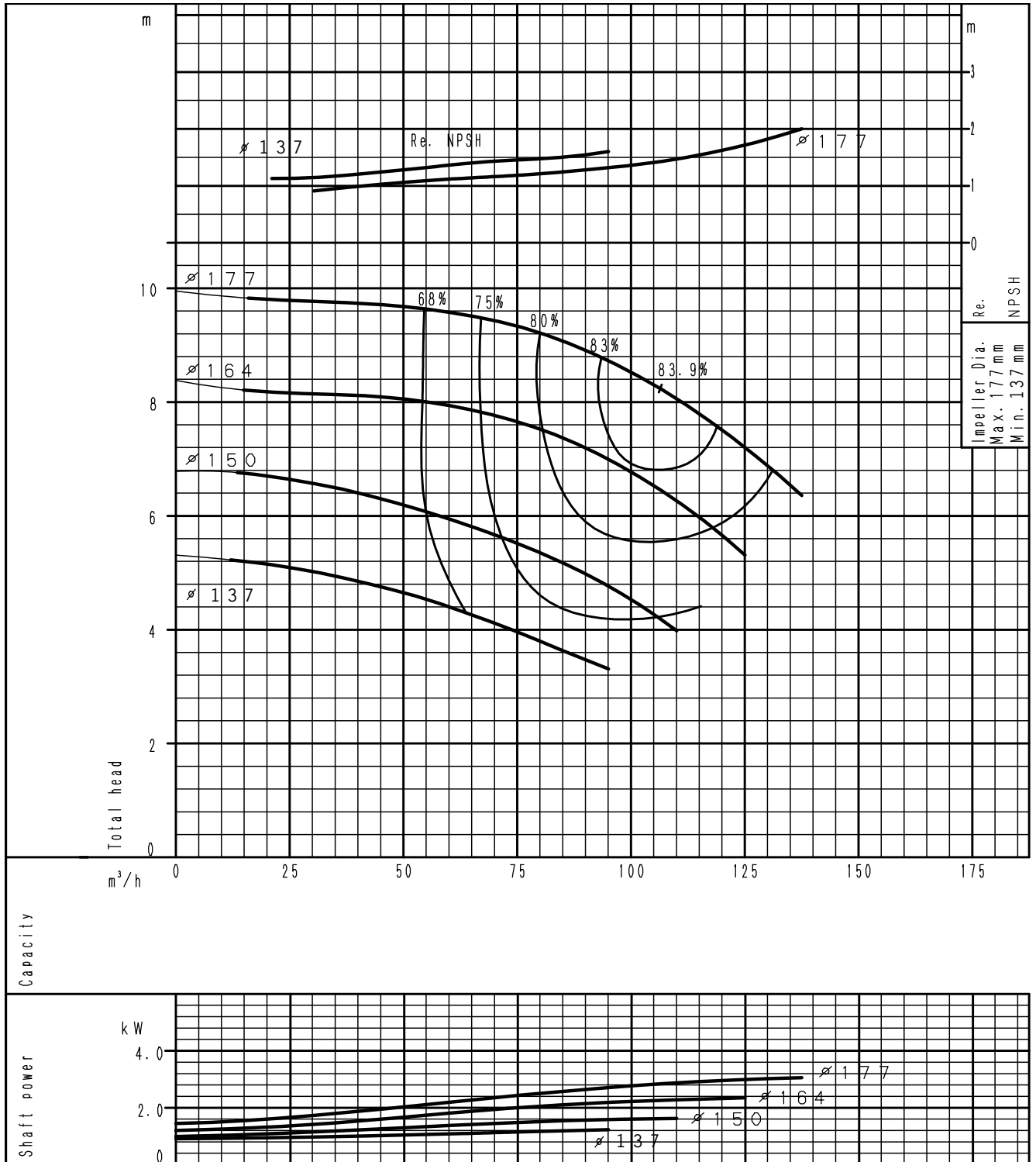

(speed 1450<sup>-1</sup>) According to ISO 9906 grade 3B

### PERFORMANCE CURVE GS 80-200

4 poles

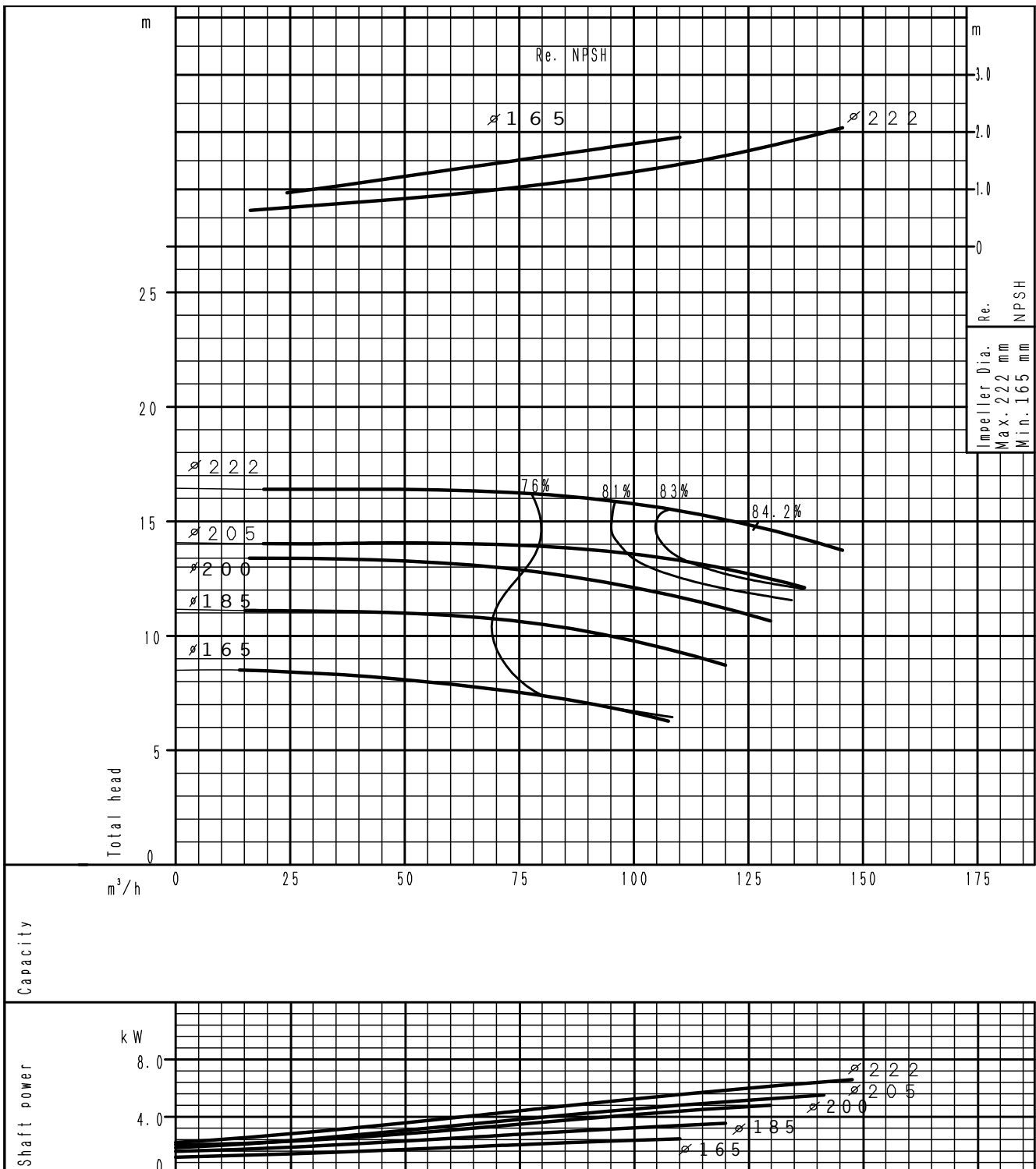

(speed 1450<sup>-1</sup>) According to ISO 9906 grade 3B

PERFORMANCE CURVE  
GS 80-250

4 poles

PERFORMANCE CURVES

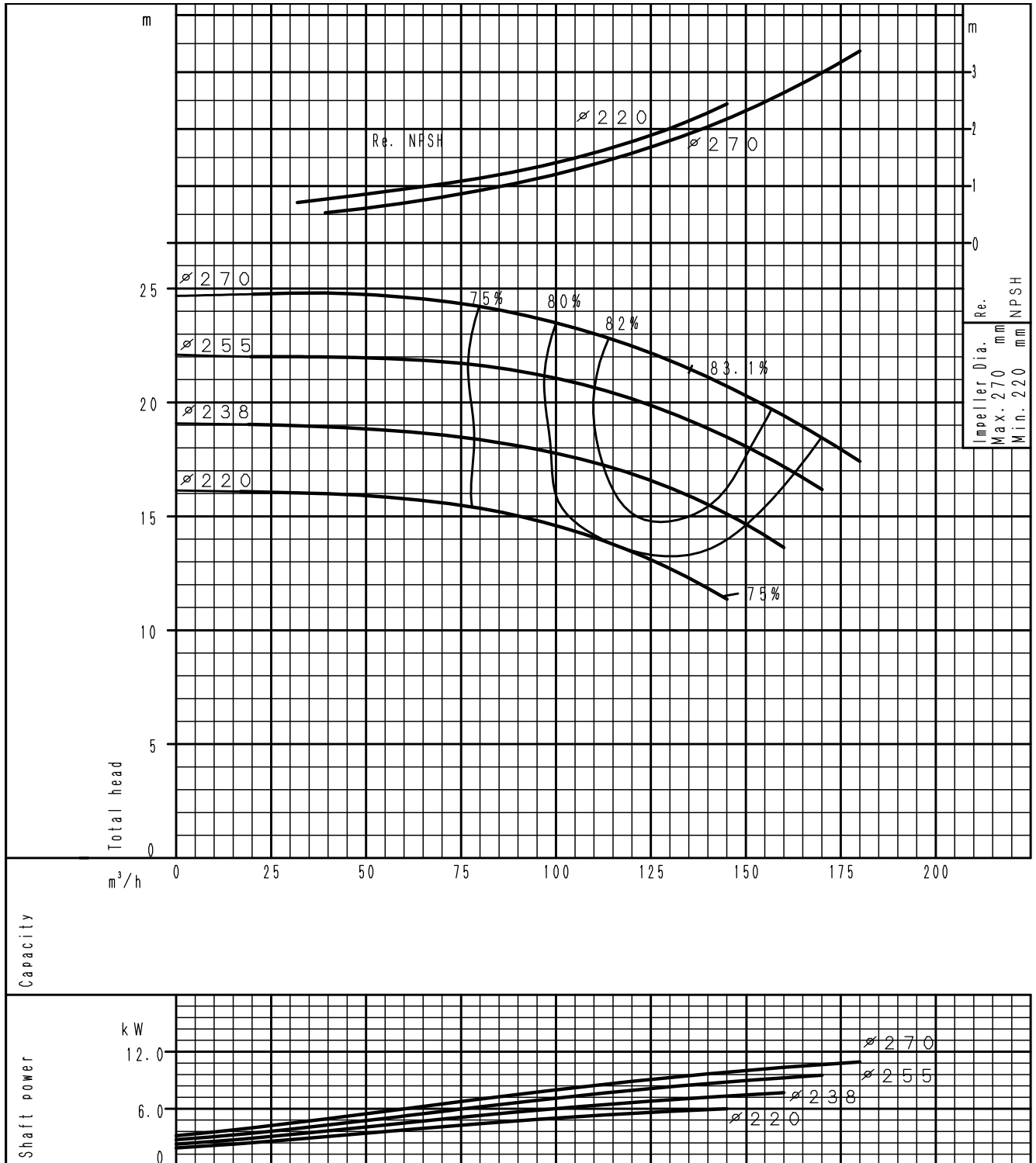

(speed 1450<sup>-1</sup>) According to ISO 9906 grade 3B

### PERFORMANCE CURVE GS 80-315

4 poles

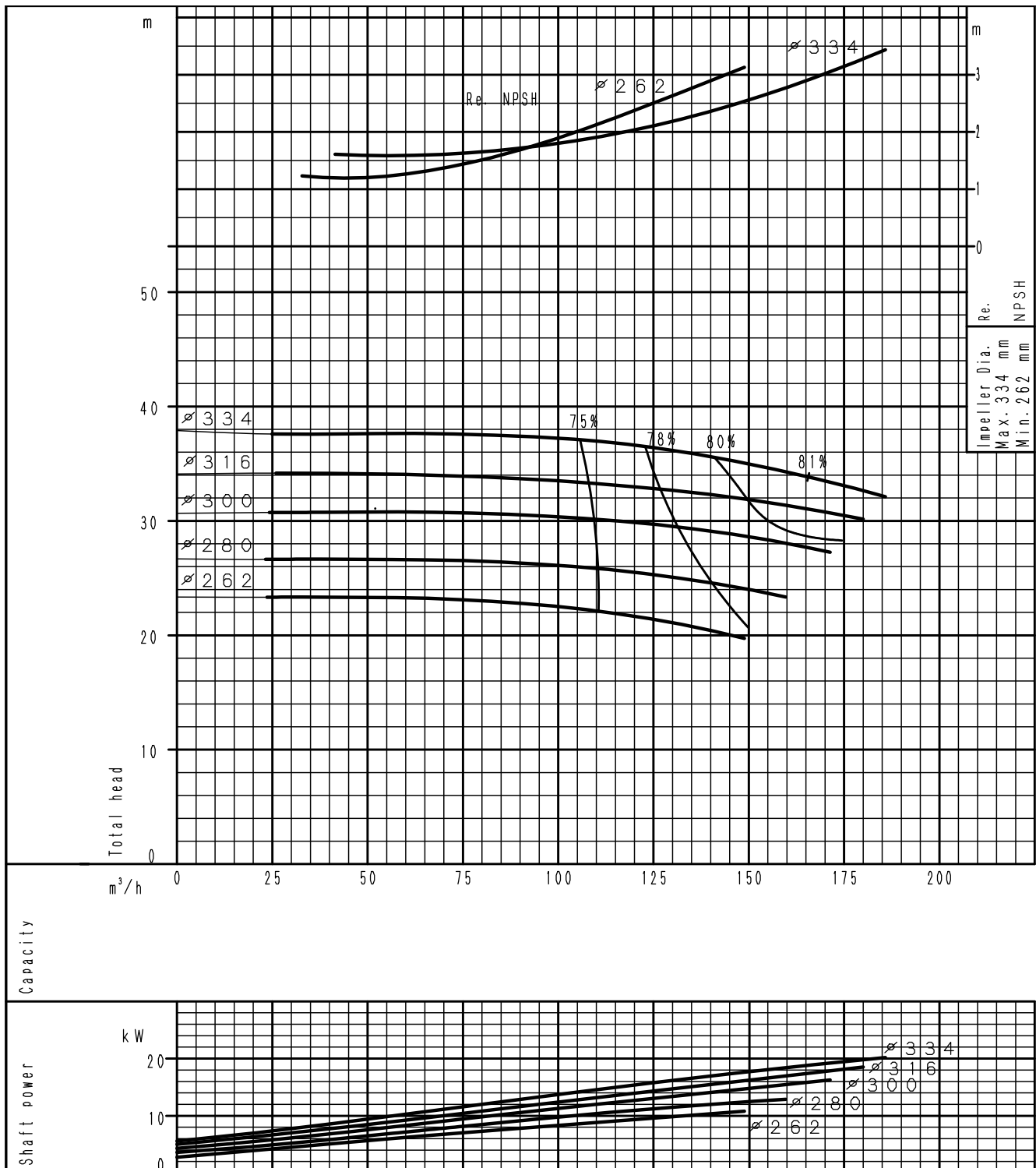

(speed 1450<sup>-1</sup>) According to ISO 9906 grade 3B

PERFORMANCE CURVE  
GS 80-400

4 poles

PERFORMANCE CURVES

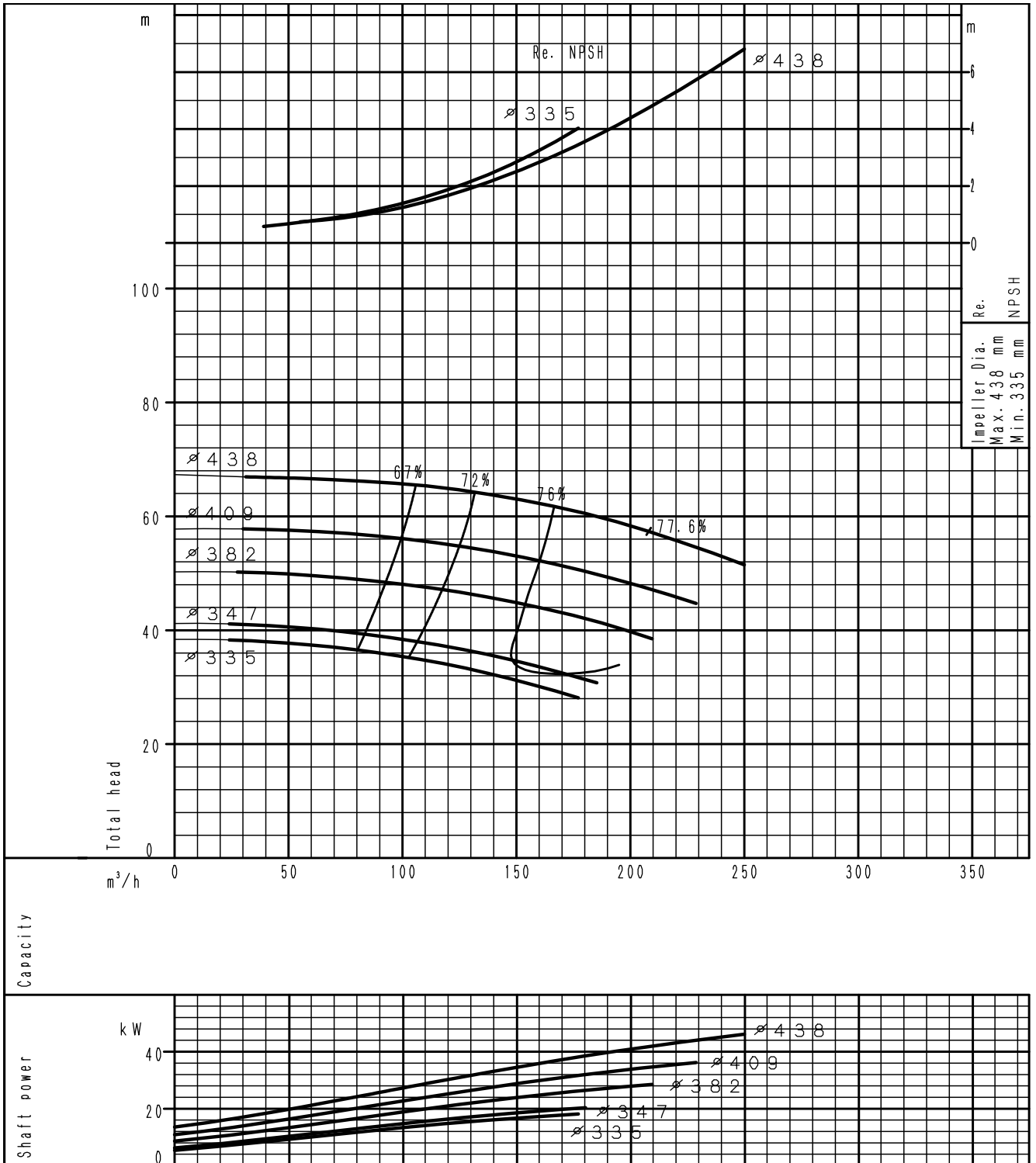

(speed 1450<sup>-1</sup>) According to ISO 9906 grade 3B

### PERFORMANCE CURVE GS 100-160

4 poles

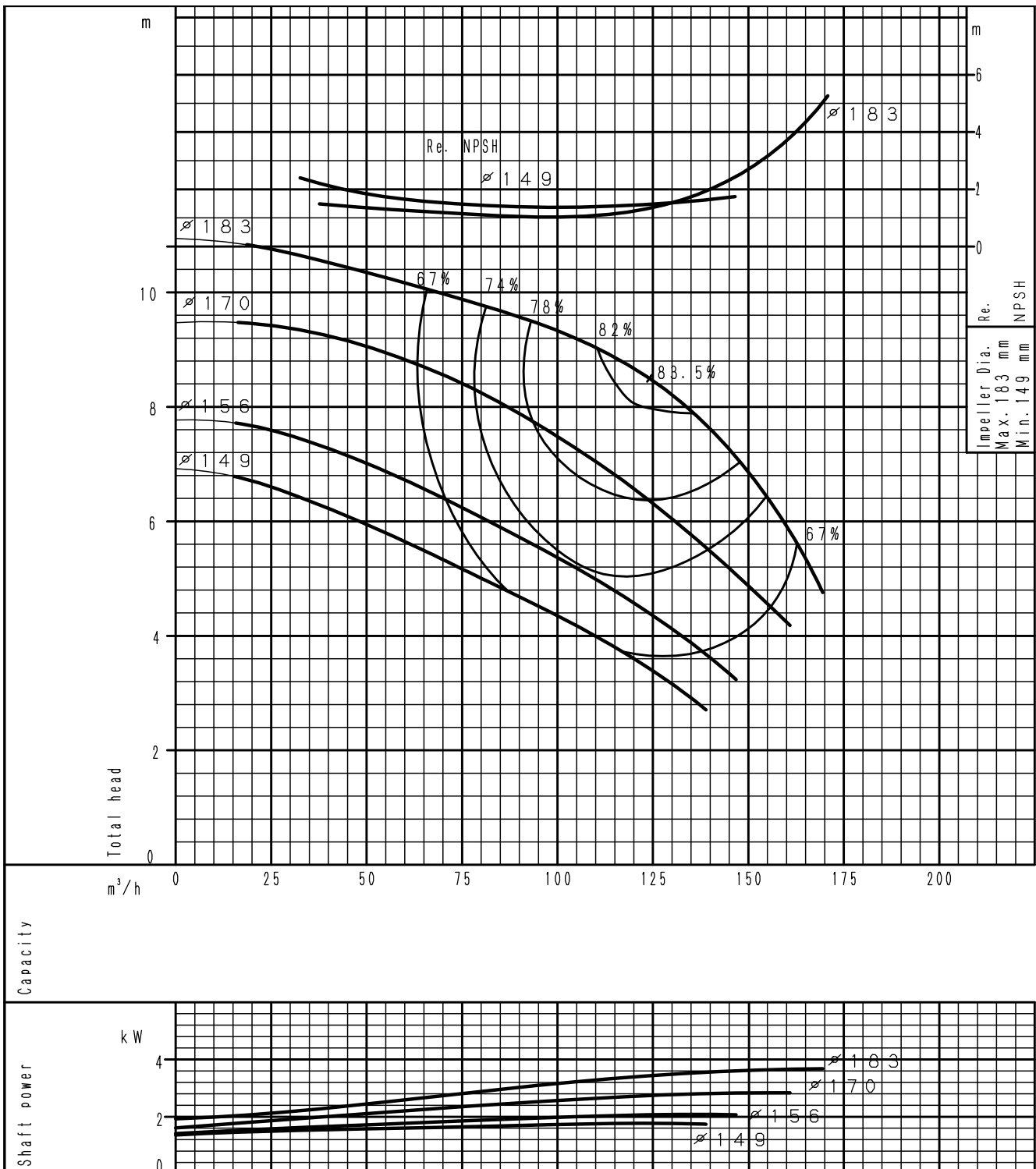

(speed 1450<sup>-1</sup>) According to ISO 9906 grade 3B

PERFORMANCE CURVE

GS 100-200

4 poles

PERFORMANCE CURVES

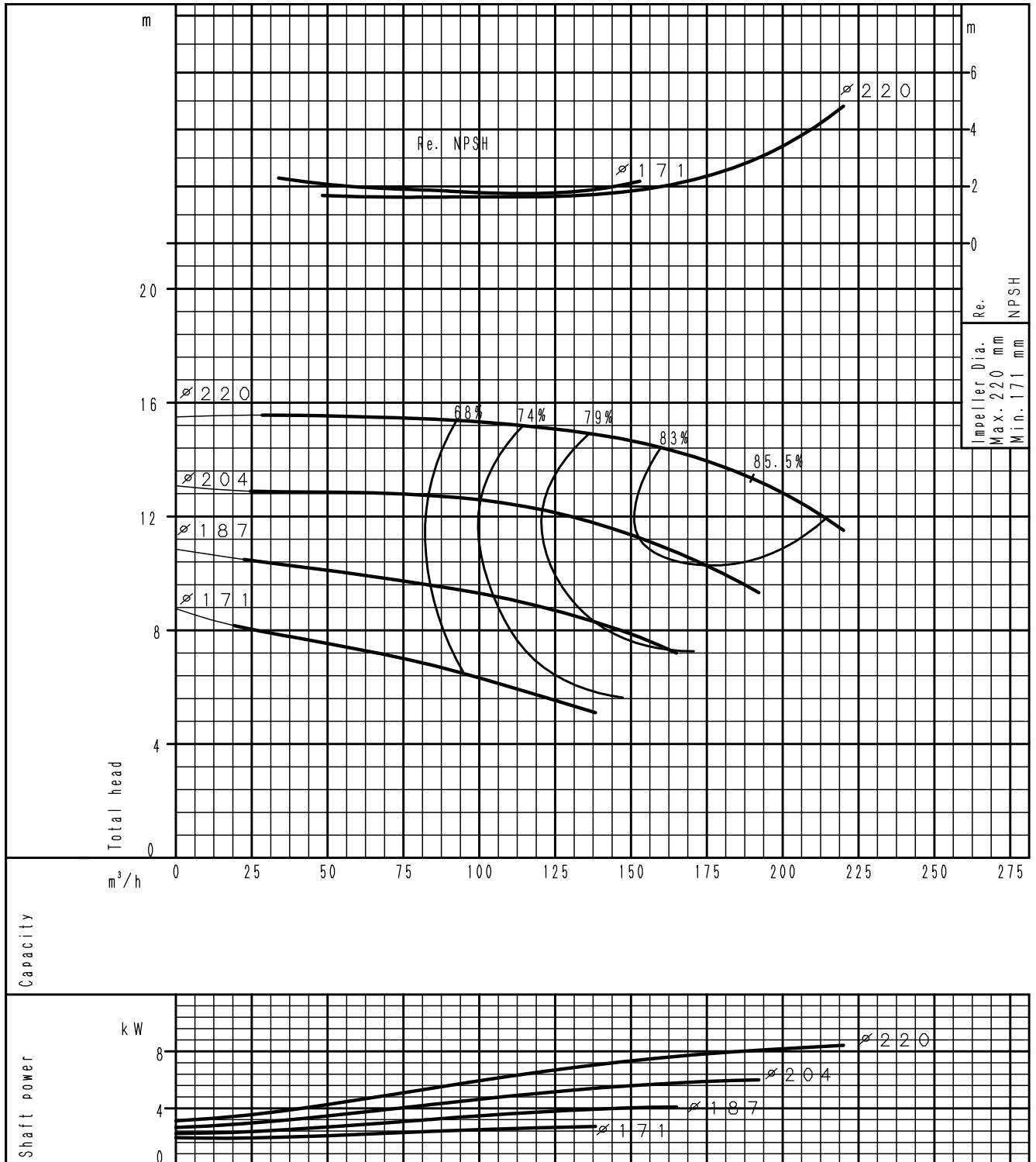

(speed 1450<sup>-1</sup>) According to ISO 9906 grade 3B



### PERFORMANCE CURVE GS 100-250

4 poles

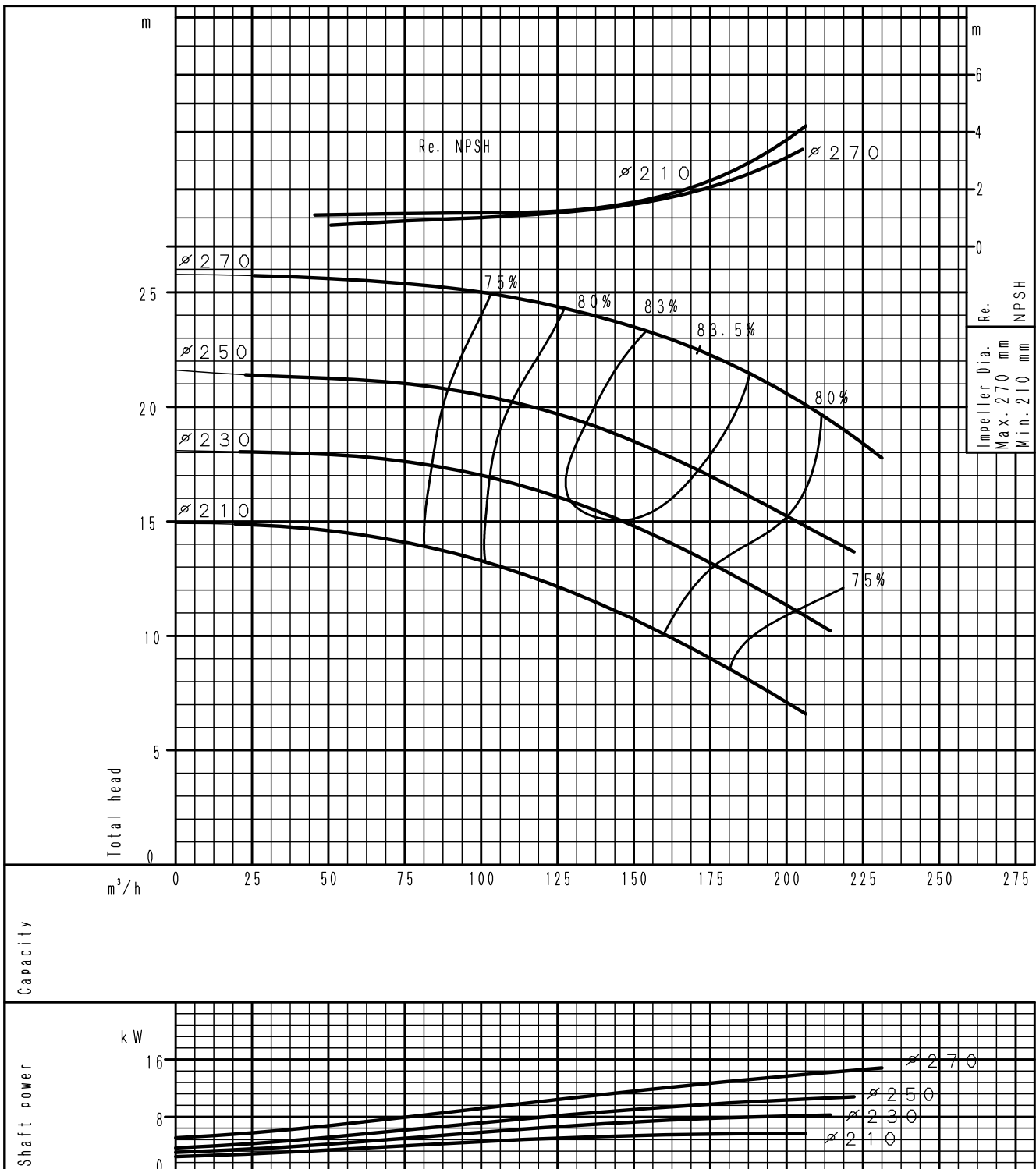

(speed 1450<sup>-1</sup>) According to ISO 9906 grade 3B

PERFORMANCE CURVE  
GS 100-315

4 poles

PERFORMANCE CURVES

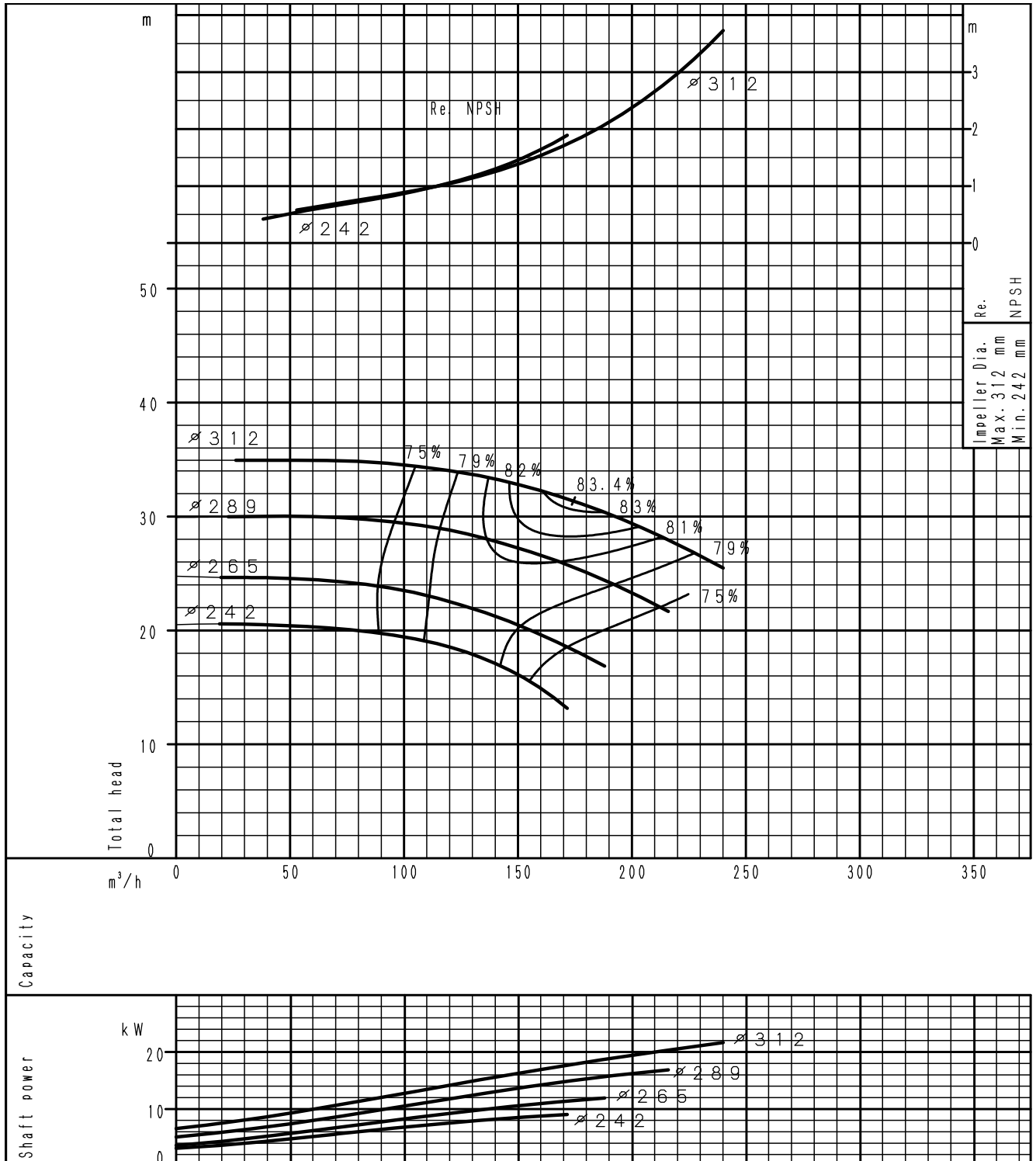

(speed 1450<sup>-1</sup>) According to ISO 9906 grade 3B

### PERFORMANCE CURVE GS 100-400

4 poles

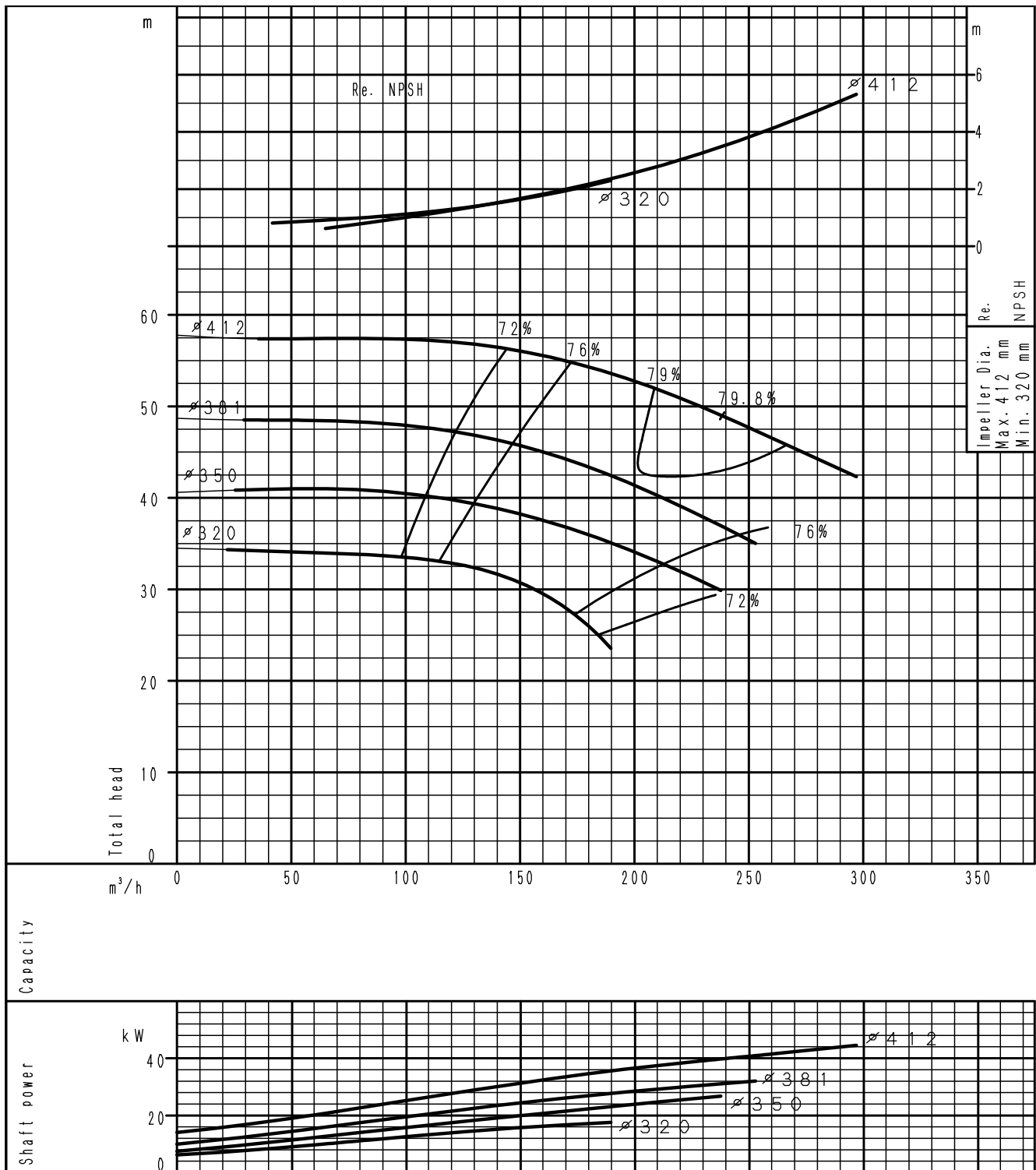

(speed 1450<sup>-1</sup>) According to ISO 9906 grade 3B

PERFORMANCE CURVE  
GS 125-200

4 poles

PERFORMANCE CURVES

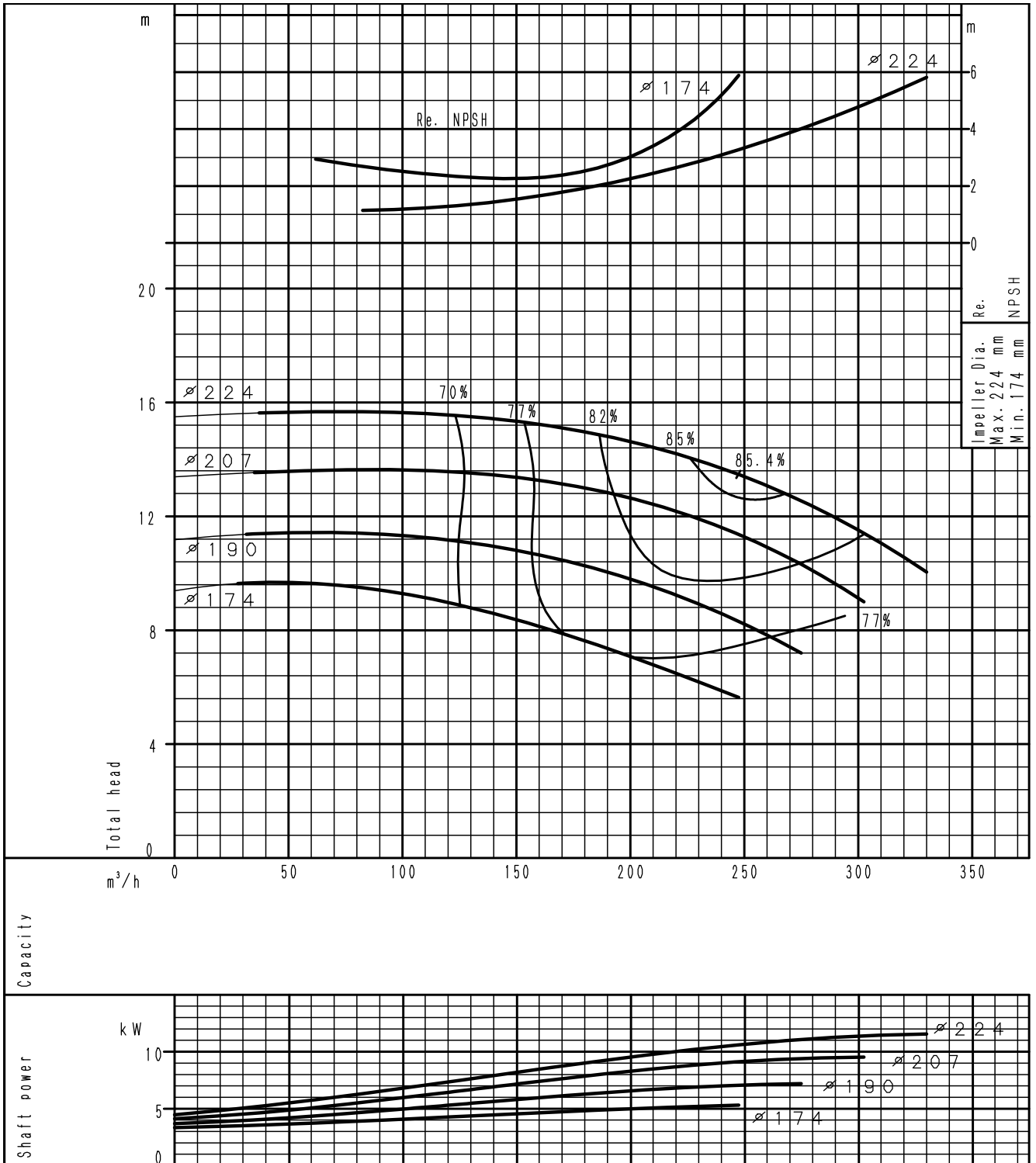

(speed 1450<sup>-1</sup>) According to ISO 9906 grade 3B

### PERFORMANCE CURVE GS 125-250

4 poles

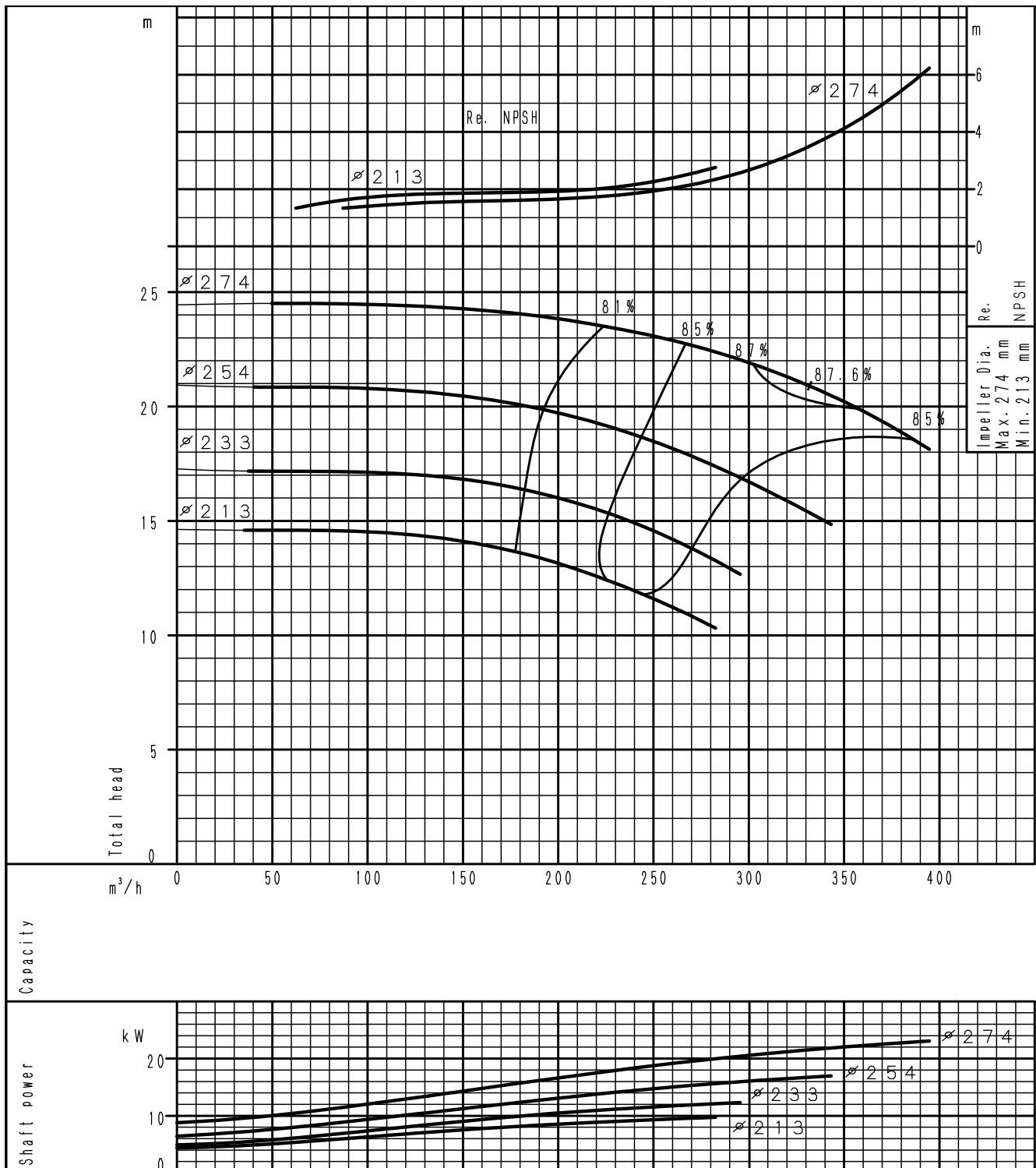

(speed 1450<sup>-1</sup>) According to ISO 9906 grade 3B

PERFORMANCE CURVE  
GS 125-315

4 poles

PERFORMANCE CURVES

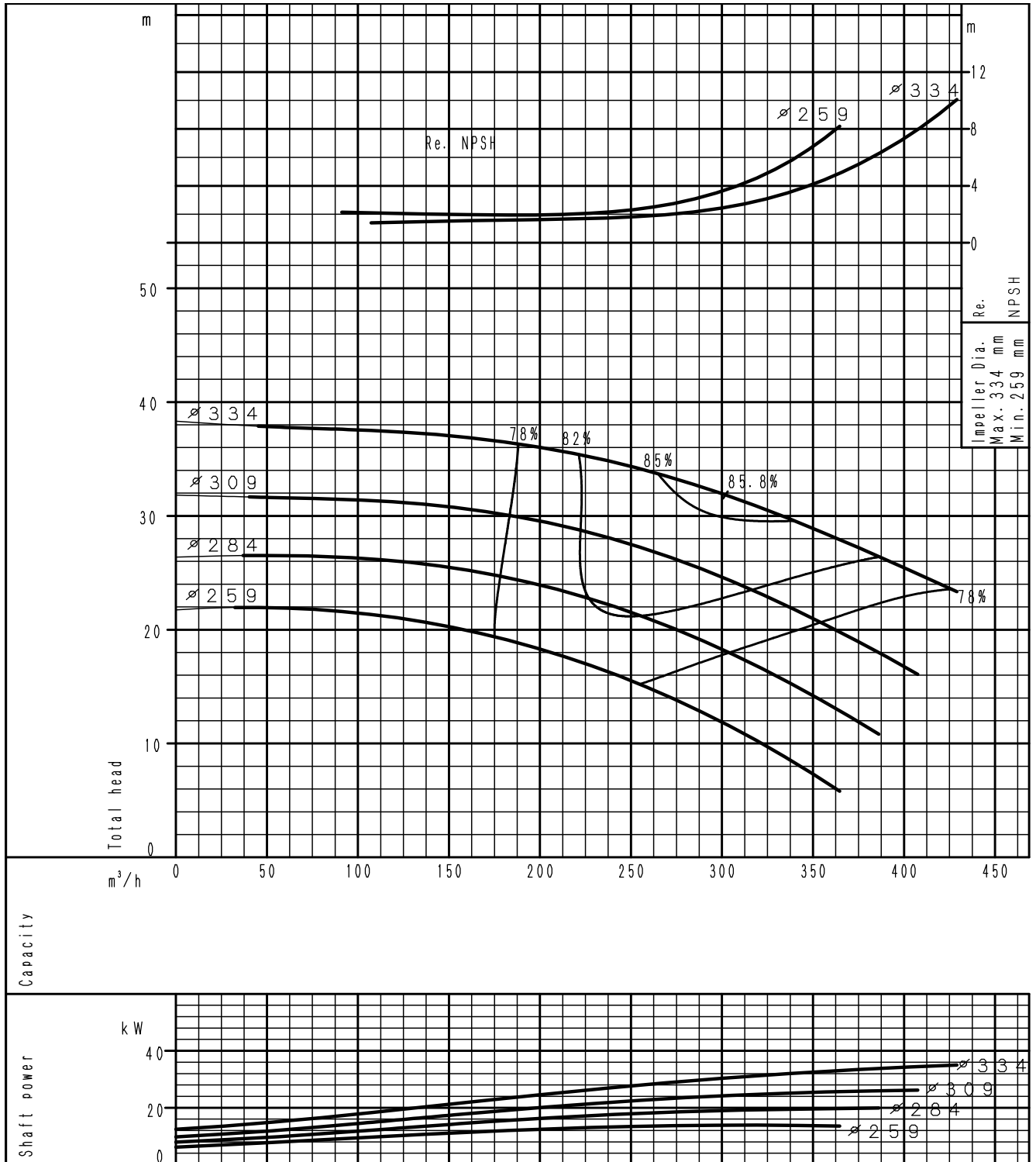

(speed 1450<sup>-1</sup>) According to ISO 9906 grade 3B

### PERFORMANCE CURVE GS 125-400

4 poles

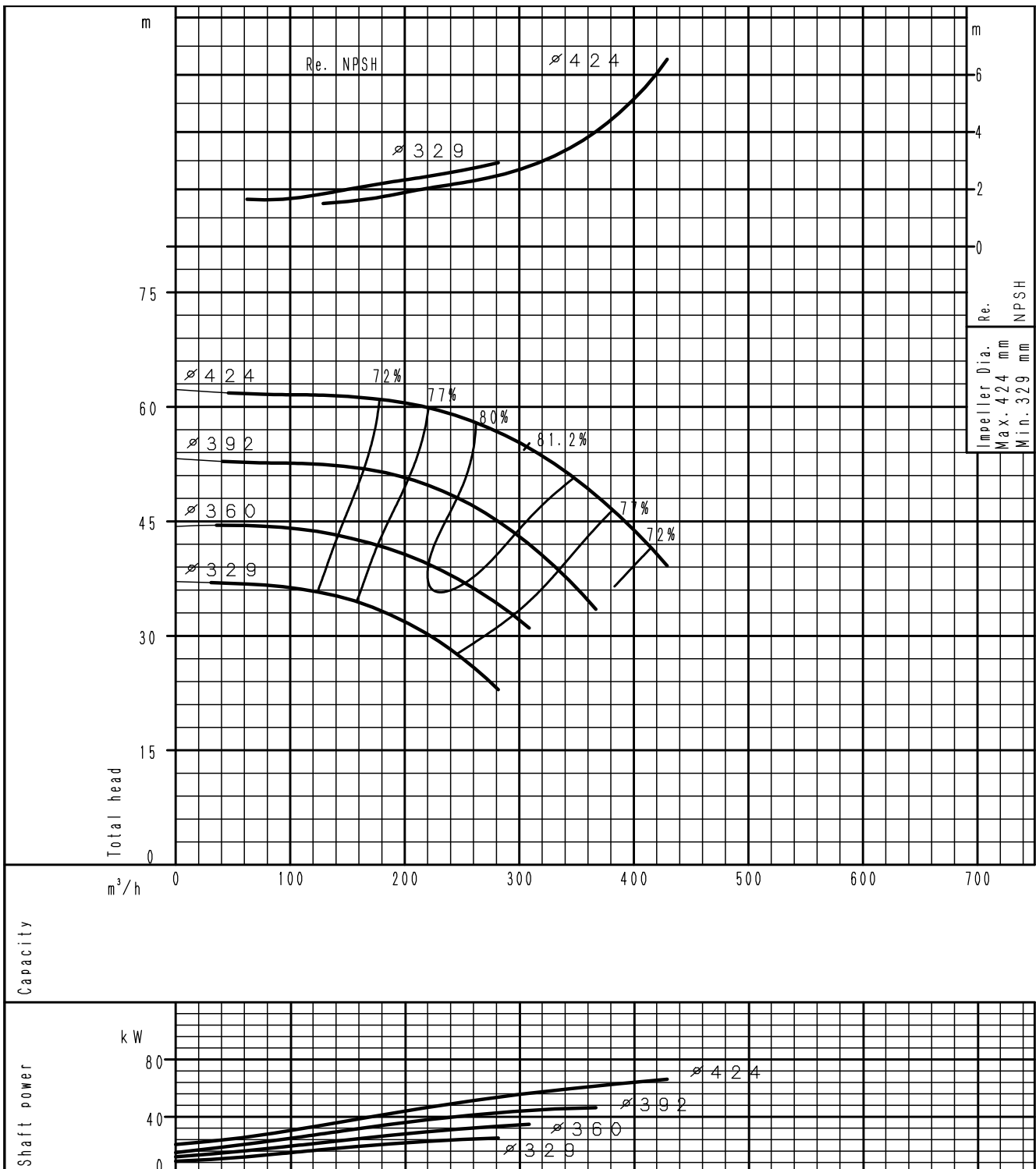

(speed 1450<sup>-1</sup>) According to ISO 9906 grade 3B

PERFORMANCE CURVE  
GS 125-500

4 poles

PERFORMANCE CURVES

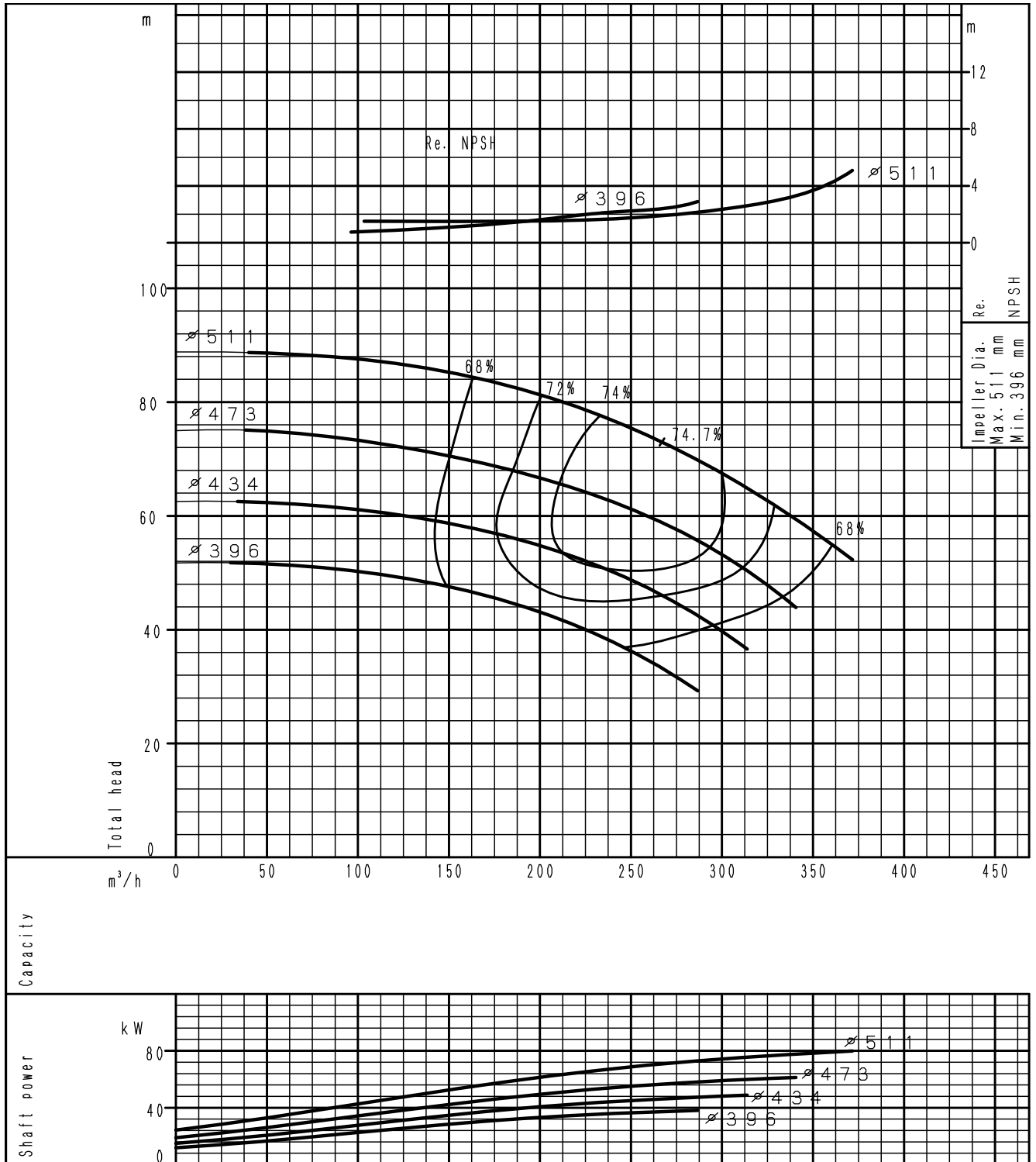

(speed 1450<sup>-1</sup>) According to ISO 9906 grade 3B



### PERFORMANCE CURVE GS 150-200

4 poles

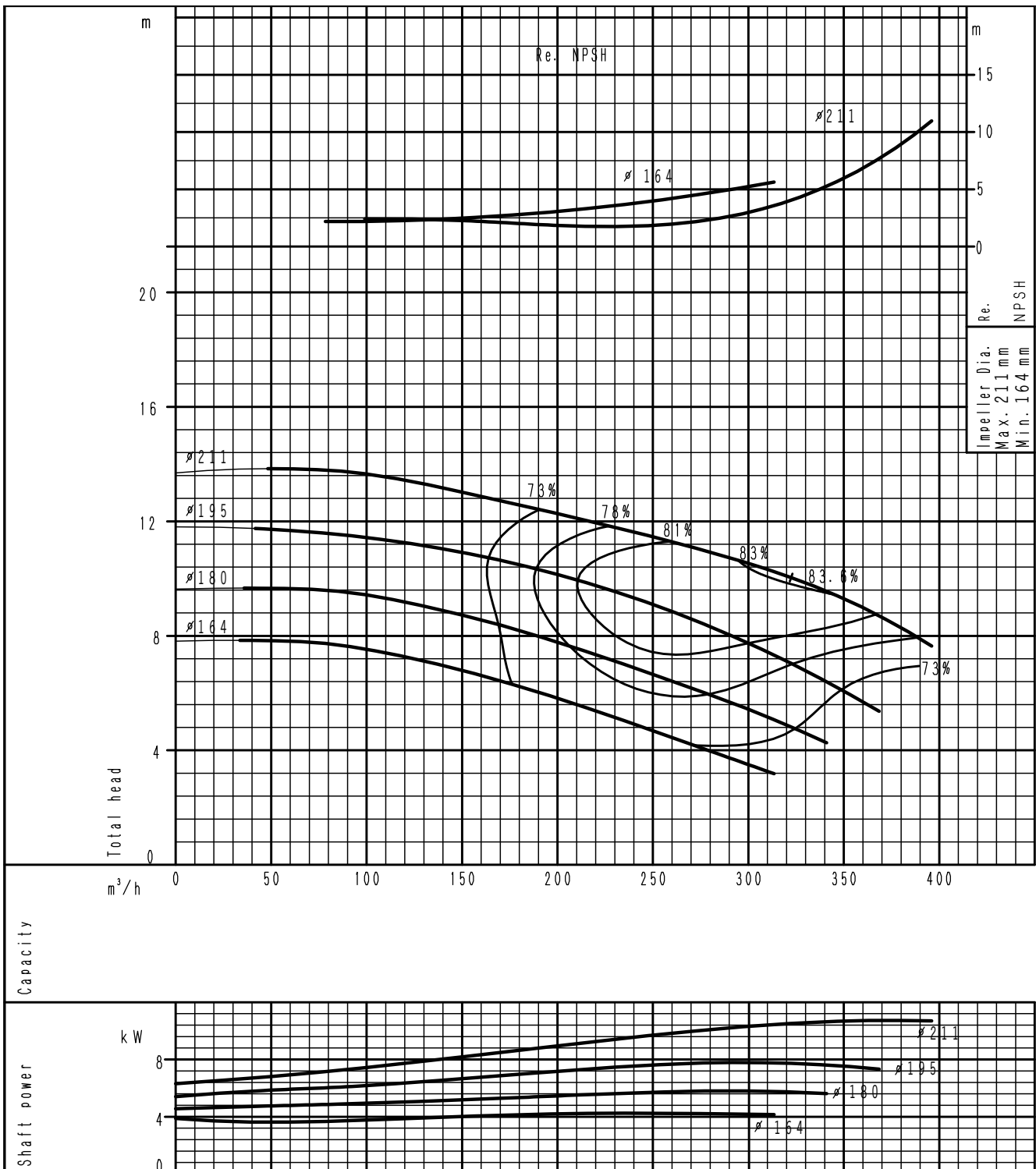

(speed 1450<sup>-1</sup>) According to ISO 9906 grade 3B

PERFORMANCE CURVE  
GS 150-250

4 poles

PERFORMANCE CURVES

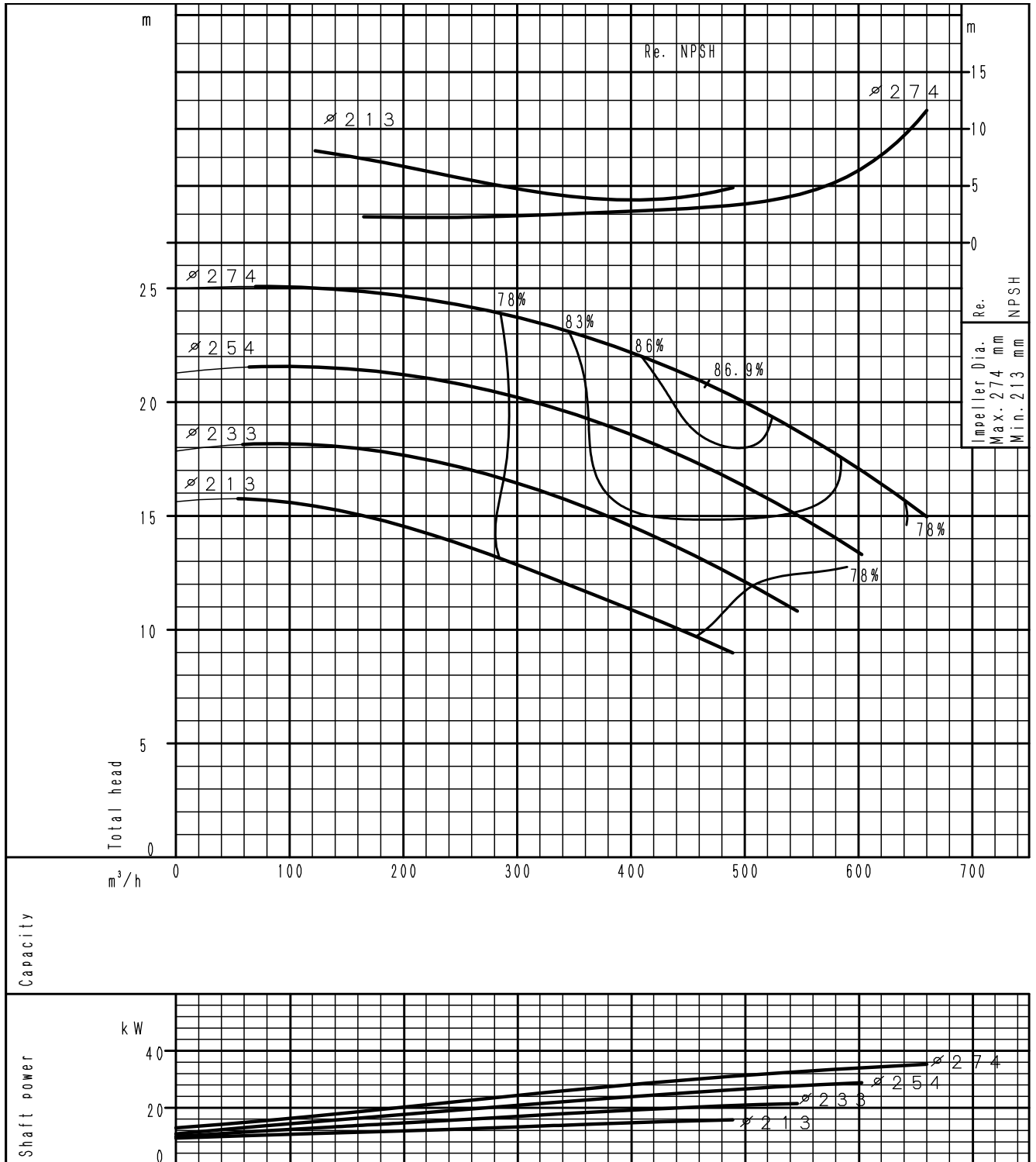

(speed 1450<sup>-1</sup>) According to ISO 9906 grade 3B

### PERFORMANCE CURVE GS 150-315

4 poles

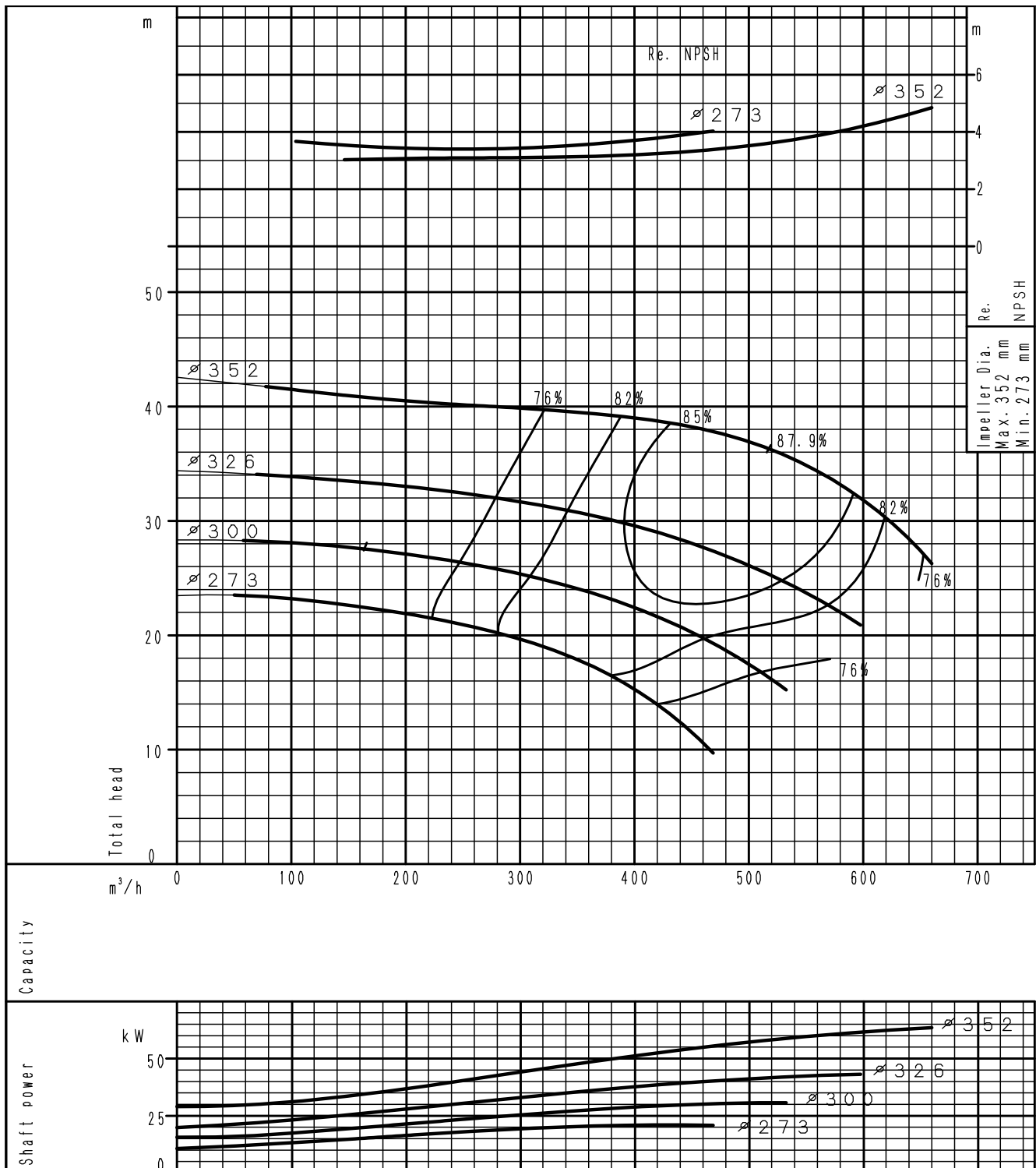

(speed 1450<sup>-1</sup>) According to ISO 9906 grade 3B

PERFORMANCE CURVE  
GS 150-400

4 poles

PERFORMANCE CURVES

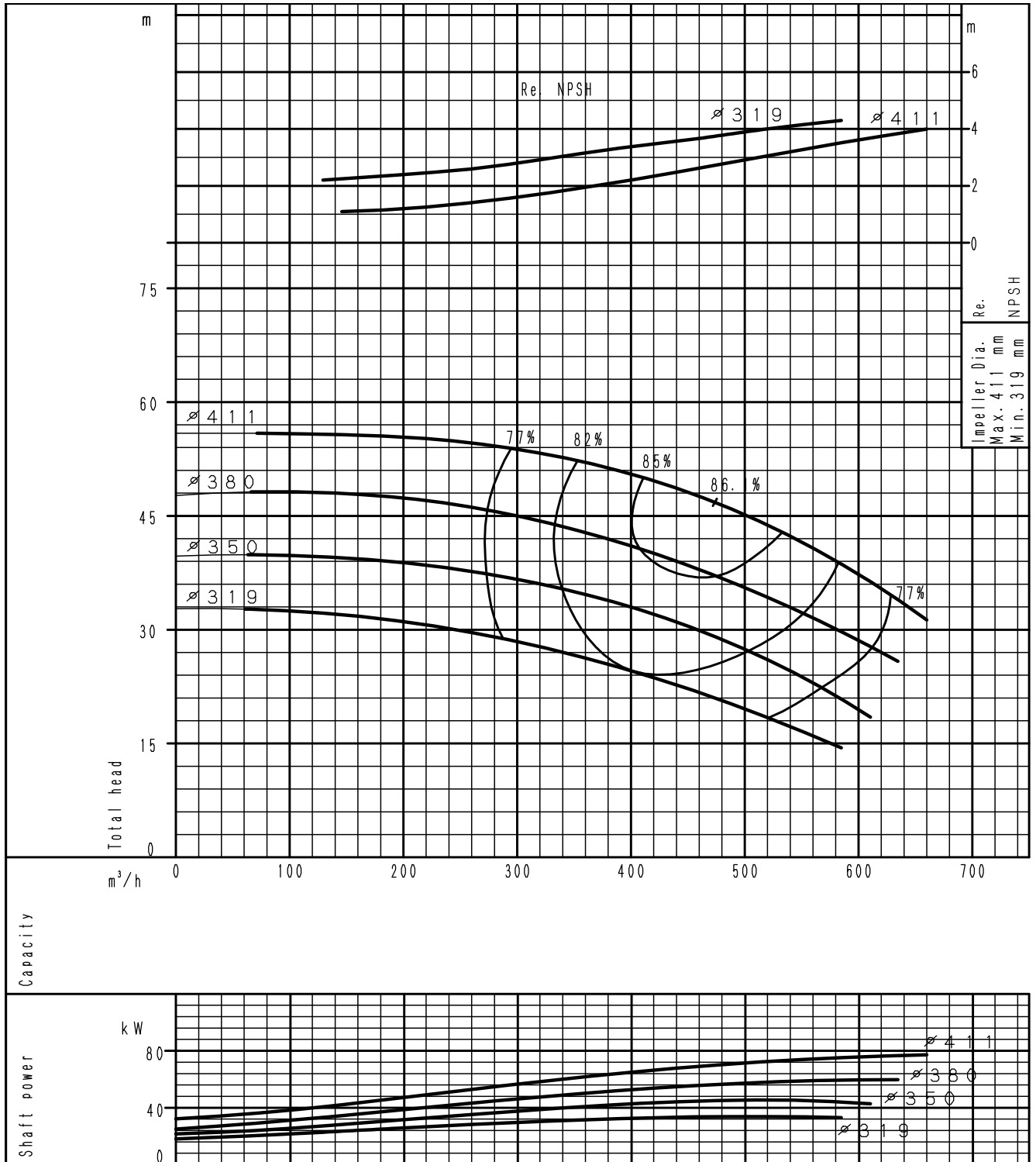

(speed 1450<sup>-1</sup>) According to ISO 9906 grade 3B

### PERFORMANCE CURVE GS 150-500

4 poles

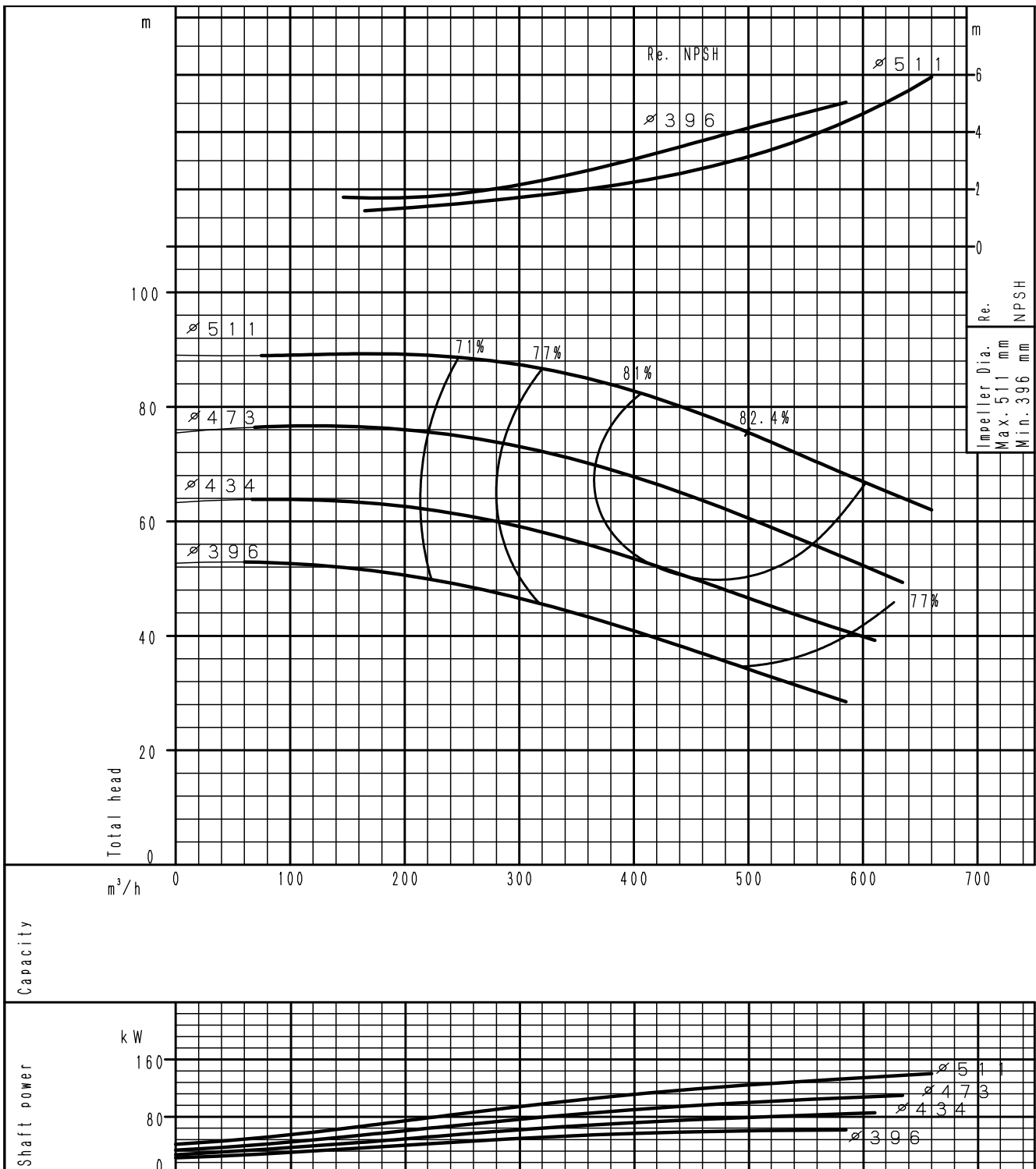

(speed 1450<sup>-1</sup>) According to ISO 9906 grade 3B

PERFORMANCE CURVE  
GS 200-400

4 poles

PERFORMANCE CURVES

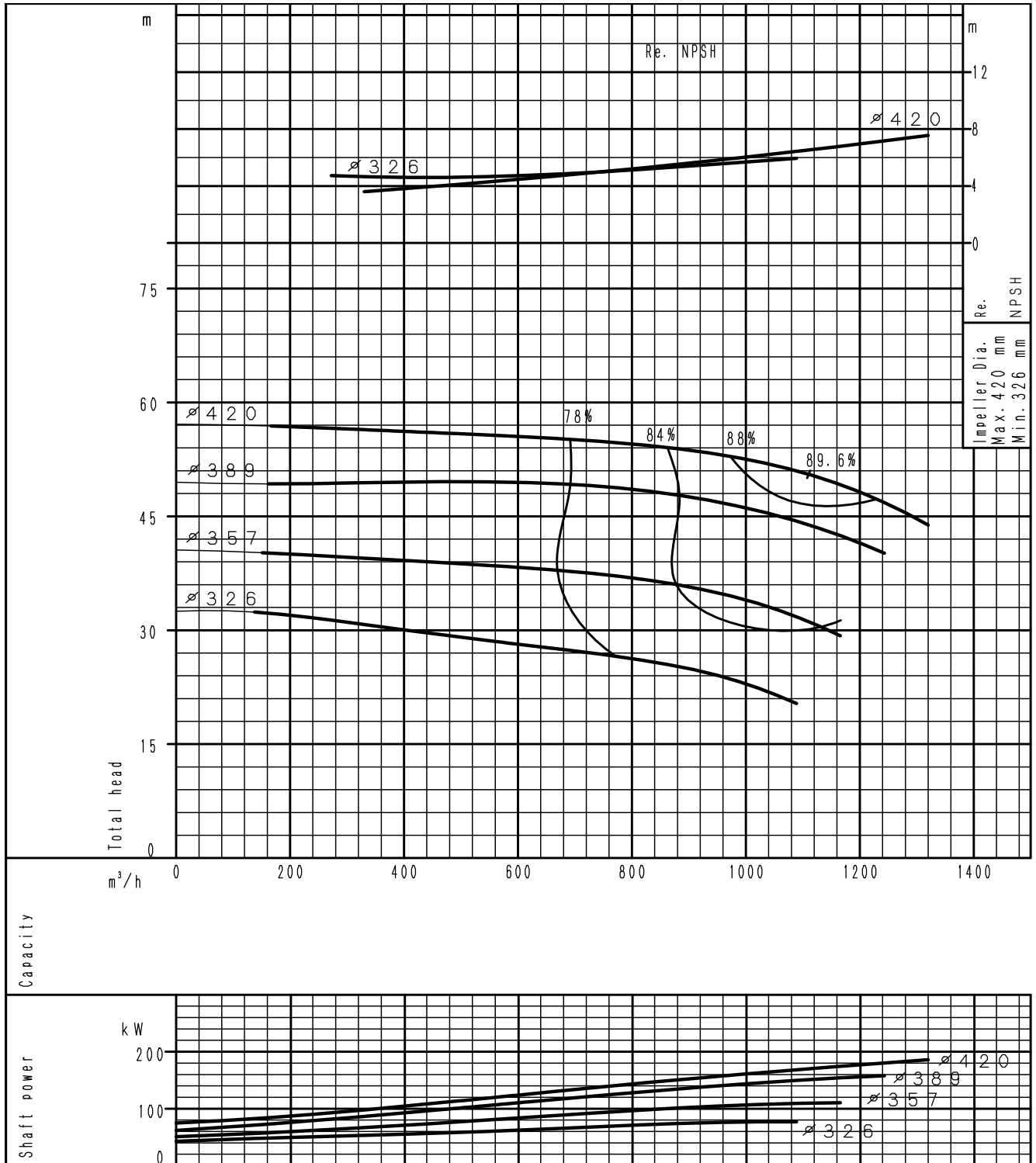

(speed 1450<sup>-1</sup>) According to ISO 9906 grade 3B

### PERFORMANCE CURVE GS 200-500

4 poles

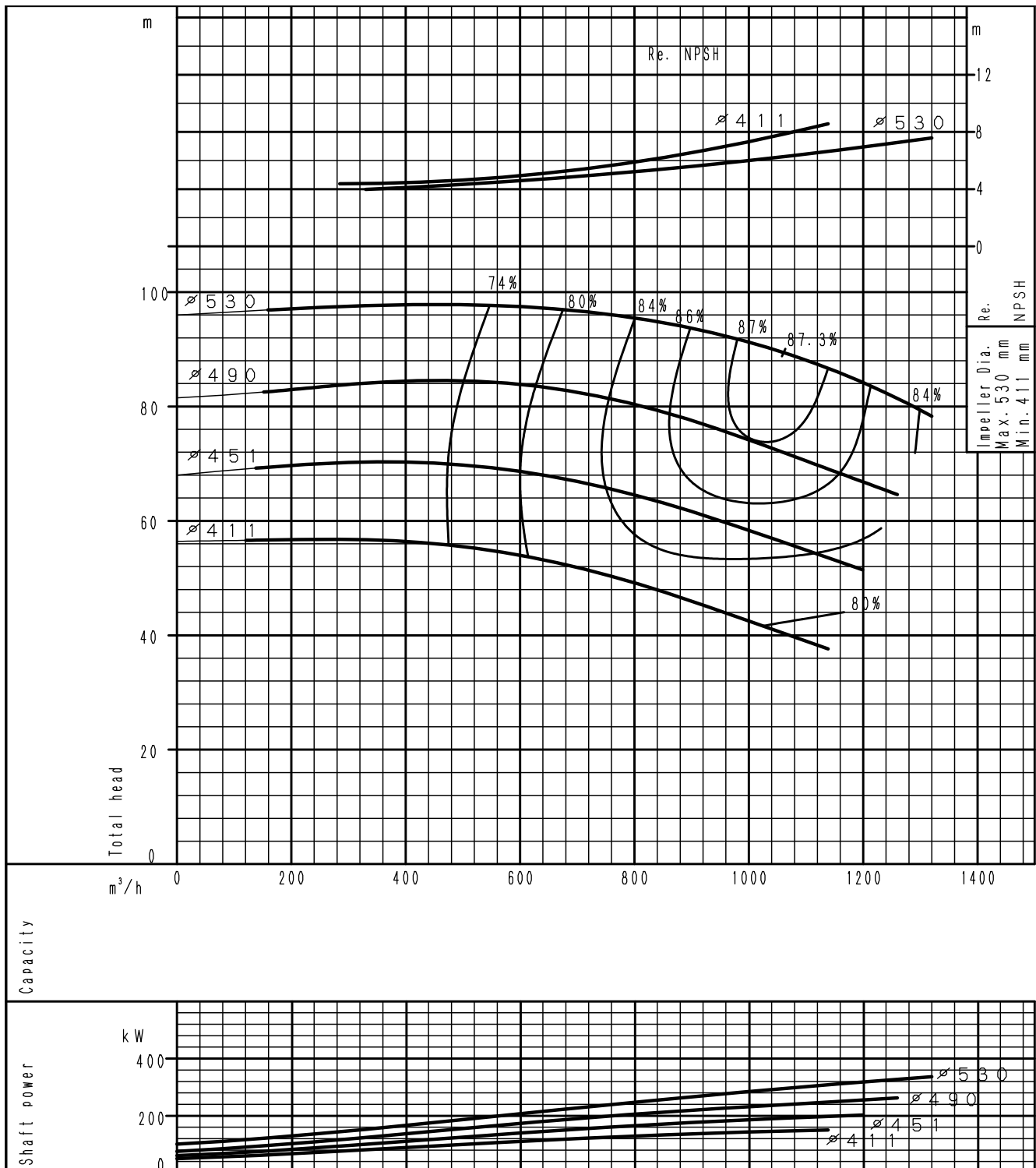

(speed 1450<sup>-1</sup>) According to ISO 9906 grade 3B

### MOTOR DATA

2900min<sup>-1</sup>

Model	Poles	Motor power P <sub>2</sub> [kW]	Motor frame MEC	Efficiency class	Absorbed Current I <sub>n</sub> [A]		Motor efficiency [%]	Power factor cos(φ)	I <sub>s</sub> /I <sub>n</sub> 400V
					230V	400V			
32-125.1	2	0,75	80	IE3	2,8	1,6	81,0	0,82	7,5
	2	1,1	80	IE3	4,0	2,3	83,0	0,82	7,4
	2	1,5	90S	IE3	5,4	3,1	84,5	0,83	7,6
	2	2,2	90L	IE3	7,7	4,4	86,3	0,83	7,5
32-125	2	0,75	80	IE3	2,8	1,6	81,0	0,82	7,5
	2	1,1	80	IE3	4,0	2,3	83,0	0,82	7,4
	2	1,5	90S	IE3	5,4	3,1	84,5	0,83	7,6
	2	2,2	90L	IE3	7,7	4,4	86,3	0,83	7,5
32-160.1	2	3	100L	IE3	10,0	5,8	87,3	0,86	8,5
	2	4	112	IE3	13,2	7,6	88,4	0,86	7,7
	2	5,5	132S	IE3	-	10,6	89,4	0,84	7,9
	2	1,5	90S	IE3	5,4	3,1	84,5	0,83	7,6
32-160	2	2,2	90L	IE3	7,7	4,4	86,3	0,83	7,5
	2	3	100L	IE3	10,0	5,8	87,3	0,86	8,5
	2	4	112	IE3	13,2	7,6	88,4	0,86	7,7
	2	5,5	132S	IE3	-	10,6	89,4	0,84	7,9
32-200.1	2	2,2	90L	IE3	7,7	4,4	86,3	0,83	7,5
	2	3	100L	IE3	10,0	5,8	87,3	0,86	8,5
	2	4	112	IE3	13,2	7,6	88,4	0,86	7,7
	2	5,5	132S	IE3	-	10,6	89,4	0,84	7,9
32-200	2	7,5	132S	IE3	-	14,1	90,3	0,85	8,8
	2	2,2	90L	IE3	7,7	4,4	86,3	0,83	7,5
	2	3	100L	IE3	10,0	5,8	87,3	0,86	8,5
	2	4	112	IE3	13,2	7,6	88,4	0,86	7,7
	2	5,5	132S	IE3	-	10,6	89,4	0,84	7,9
	2	7,5	132S	IE3	-	14,1	90,3	0,85	8,8
	2	11	160M	IE3	-	19,3	91,2	0,90	7,9
32-250	2	15	160M	IE3	-	25,9	91,9	0,91	7,9
	2	18,5	160L	IE3	-	31,4	92,4	0,92	8,0
	2	7,5	132S	IE3	-	14,1	90,3	0,85	8,8
	2	11	160M	IE3	-	19,3	91,2	0,90	7,9
40-125	2	1,1	80	IE3	4,0	2,3	83,0	0,82	7,4
	2	1,5	90S	IE3	5,4	3,1	84,5	0,83	7,6
	2	2,2	90L	IE3	7,7	4,4	86,3	0,83	7,5
	2	3	100L	IE3	10,0	5,8	87,3	0,86	8,5
	2	4	112	IE3	13,2	7,6	88,4	0,86	7,7
	2	5,5	132S	IE3	-	10,6	89,4	0,84	7,9
40-160	2	1,5	90S	IE3	5,4	3,1	84,5	0,83	7,6
	2	2,2	90L	IE3	7,7	4,4	86,3	0,83	7,5
	2	3	100L	IE3	10,0	5,8	87,3	0,86	8,5
	2	4	112	IE3	13,2	7,6	88,4	0,86	7,7
	2	5,5	132S	IE3	-	10,6	89,4	0,84	7,9
	2	7,5	132S	IE3	-	14,1	90,3	0,85	8,8
	2	11	160M	IE3	-	19,3	91,2	0,90	7,9
40-200	2	3	100L	IE3	10,0	5,8	87,3	0,86	8,5
	2	4	112	IE3	13,2	7,6	88,4	0,86	7,7
	2	5,5	132S	IE3	-	10,6	89,4	0,84	7,9
	2	7,5	132S	IE3	-	14,1	90,3	0,85	8,8
	2	11	160M	IE3	-	19,3	91,2	0,90	7,9
	2	15	160M	IE3	-	25,9	91,9	0,91	7,9
	2	18,5	160L	IE3	-	31,4	92,4	0,92	8,0
40-250	2	7,5	132S	IE3	-	14,1	90,3	0,85	8,8
	2	11	160M	IE3	-	19,3	91,2	0,90	7,9
	2	15	160M	IE3	-	25,9	91,9	0,91	7,9
	2	18,5	160L	IE3	-	31,4	92,4	0,92	8,0
	2	22	180M	IE3	-	38,5	92,7	0,89	7,5
	2	30	200L	IE3	-	52,7	93,3	0,88	6,7
40-315	2	15	160M	IE3	-	25,9	91,9	0,91	7,9
	2	18,5	160L	IE3	-	31,4	92,4	0,92	8,0
	2	22	180M	IE3	-	38,5	92,7	0,89	7,5
	2	30	200L	IE3	-	52,7	93,3	0,88	6,7
	2	37	200L	IE3	-	63,3	93,7	0,90	6,3
2	45	225M	IE3	-	78,5	94,0	0,88	6,9	



### MOTOR DATA 2900min<sup>-1</sup>

Model	Poles	kW	MEC	Efficiency	In A		% Eff	PF (cos.f)	Is/In (400V)
					230V	400V			
50-125	2	1,5	90S	IE3	5,4	3,1	84,5	0,83	7,6
	2	2,2	90L	IE3	7,7	4,4	86,3	0,83	7,5
	2	3	100L	IE3	10,0	5,8	87,3	0,86	8,5
	2	4	112	IE3	13,2	7,6	88,4	0,86	7,7
	2	5,5	132S	IE3	-	10,6	89,4	0,84	7,9
	2	7,5	132S	IE3	-	14,1	90,3	0,85	8,8
50-160	2	2,2	90L	IE3	7,7	4,4	86,3	0,83	7,5
	2	3	100L	IE3	10,0	5,8	87,3	0,86	8,5
	2	4	112	IE3	13,2	7,6	88,4	0,86	7,7
	2	5,5	132S	IE3	-	10,6	89,4	0,84	7,9
	2	7,5	132S	IE3	-	14,1	90,3	0,85	8,8
	2	11	160M	IE3	-	19,3	91,2	0,90	7,9
50-200	2	15	160M	IE3	-	25,9	91,9	0,91	7,9
	2	3	100L	IE3	10,0	5,8	87,3	0,86	8,5
	2	4	112	IE3	13,2	7,6	88,4	0,86	7,7
	2	5,5	132S	IE3	-	10,6	89,4	0,84	7,9
	2	7,5	132S	IE3	-	14,1	90,3	0,85	8,8
	2	11	160M	IE3	-	19,3	91,2	0,90	7,9
	2	15	160M	IE3	-	25,9	91,9	0,91	7,9
	2	18,5	160L	IE3	-	31,4	92,4	0,92	8,0
50-250	2	22	180M	IE3	-	38,5	92,7	0,89	7,5
	2	30	200L	IE3	-	52,7	93,3	0,88	6,7
	2	15	160M	IE3	-	25,9	91,9	0,91	7,9
	2	18,5	160L	IE3	-	31,4	92,4	0,92	8
	2	22	180M	IE3	-	38,5	92,7	0,89	7,5
	2	30	200L	IE3	-	52,7	93,3	0,88	6,7
	2	37	200L	IE3	-	63,3	93,7	0,90	6,3
50-315	2	45	225M	IE3	-	78,5	94,0	0,88	6,9
	2	22	180M	IE3	-	38,5	92,7	0,89	7,5
	2	30	200L	IE3	-	52,7	93,3	0,88	6,7
	2	37	200L	IE3	-	63,3	93,7	0,90	6,3
	2	45	225M	IE3	-	78,5	94,0	0,88	6,9
	2	55	250M	IE3	-	95,7	94,3	0,88	8,0
65-125	2	75	280S	IE3	-	124,0	94,7	0,92	8,0
	2	3	100L	IE3	10,0	5,8	87,3	0,86	8,5
	2	4	112	IE3	13,2	7,6	88,4	0,86	7,7
	2	5,5	132S	IE3	-	10,6	89,4	0,84	7,9
	2	7,5	132S	IE3	-	14,1	90,3	0,85	8,8
	2	11	160M	IE3	-	19,3	91,2	0,90	7,9
65-160	2	5,5	132S	IE3	-	10,6	89,4	0,84	7,9
	2	7,5	132S	IE3	-	14,1	90,3	0,85	8,8
	2	11	160M	IE3	-	19,3	91,2	0,90	7,9
	2	15	160M	IE3	-	25,9	91,9	0,91	7,9
	2	18,5	160L	IE3	-	31,4	92,4	0,92	8,0
65-200	2	11	160M	IE3	-	19,3	91,2	0,90	7,9
	2	15	160M	IE3	-	25,9	91,9	0,91	7,9
	2	18,5	160L	IE3	-	31,4	92,4	0,92	8,0
	2	22	180M	IE3	-	38,5	92,7	0,89	7,5
	2	30	200L	IE3	-	52,7	93,3	0,88	6,7
65-250	2	18,5	160L	IE3	-	31,4	92,4	0,92	8,0
	2	22	180M	IE3	-	38,5	92,7	0,89	7,5
	2	30	200L	IE3	-	52,7	93,3	0,88	6,7
	2	37	200L	IE3	-	63,3	93,7	0,90	6,3
	2	45	225M	IE3	-	78,5	94,0	0,88	6,9
65-315	2	30	200L	IE3	-	52,7	93,3	0,88	6,7
	2	37	200L	IE3	-	63,3	93,7	0,90	6,3
	2	45	225M	IE3	-	78,5	94,0	0,88	6,9
	2	55	250M	IE3	-	95,7	94,3	0,88	8,0
	2	75	280S	IE3	-	124,0	94,7	0,92	8,0
	2	90	280M	IE3	-	149,0	95,0	0,92	7,7
	2	110	315S	IE3	-	185,0	95,2	0,90	7,7

### MOTOR DATA

2900min<sup>-1</sup>

Model	Poles	kW	MEC	Efficiency	In A 400V	% Eff	PF (cos.φ)	Is/In (400V)
80-160	2	7,5	132S	IE3	14,1	90,3	0,85	8,8
	2	11	160M	IE3	19,3	91,2	0,90	7,9
	2	15	160M	IE3	25,9	91,9	0,91	7,9
	2	18,5	160L	IE3	31,4	92,4	0,92	8,0
	2	22	180M	IE3	38,5	92,7	0,89	7,5
	2	30	200L	IE3	52,7	93,3	0,88	6,7
80-200	2	15	160M	IE3	25,9	91,9	0,91	7,9
	2	18,5	160L	IE3	31,4	92,4	0,92	8,0
	2	22	180M	IE3	38,5	92,7	0,89	7,5
	2	30	200L	IE3	52,7	93,3	0,88	6,7
	2	37	200L	IE3	63,3	93,7	0,90	6,3
	2	45	225M	IE3	78,5	94,0	0,88	6,9
80-250	2	55	250M	IE3	95,7	94,3	0,88	8,0
	2	22	180M	IE3	38,5	92,7	0,89	7,5
	2	30	200L	IE3	52,7	93,3	0,88	6,7
	2	37	200L	IE3	63,3	93,7	0,90	6,3
	2	45	225M	IE3	78,5	94,0	0,88	6,9
	2	55	250M	IE3	95,7	94,3	0,88	8,0
80-315L	2	75	280S	IE3	124,0	94,7	0,92	8,0
	2	90	280M	IE3	149,0	95,0	0,92	7,7
	2	75	280S	IE3	124,0	94,7	0,92	8,0
	2	90	280M	IE3	149,0	95,0	0,92	7,7
	2	110	315S	IE3	185,0	95,2	0,90	7,7
	2	132	315M	IE3	219,0	95,4	0,91	7,6
100-160	2	160	315M	IE3	268,0	95,8	0,90	7,8
	2	18,5	160L	IE3	31,4	92,4	0,92	8,0
	2	22	180M	IE3	38,5	92,7	0,89	7,5
	2	30	200L	IE3	52,7	93,3	0,88	6,7
	2	37	200L	IE3	63,3	93,7	0,90	6,3
	100-200	2	18,5	160L	IE3	31,4	92,4	0,92
2		22	180M	IE3	38,5	92,7	0,89	7,5
2		30	200L	IE3	52,7	93,3	0,88	6,7
2		37	200L	IE3	63,3	93,7	0,90	6,3
2		45	225M	IE3	78,5	94,0	0,88	6,9
2		55	250M	IE3	95,7	94,3	0,88	8,0
100-250	2	75	280S	IE3	124,0	94,7	0,92	8,0
	2	30	200L	IE3	52,7	93,3	0,88	6,7
	2	37	200L	IE3	63,3	93,7	0,90	6,3
	2	45	225M	IE3	78,5	94,0	0,88	6,9
	2	55	250M	IE3	95,7	94,3	0,88	8,0
	2	75	280S	IE3	124,0	94,7	0,92	8,0
100-315L	2	90	280M	IE3	149,0	95,0	0,92	7,7
	2	110	315S	IE3	185,0	95,2	0,90	7,7
	2	75	280S	IE3	124,0	94,7	0,92	8,0
	2	90	280M	IE3	149,0	95,0	0,92	7,7
	2	110	315S	IE3	185,0	95,2	0,90	7,7
	2	132	315M	IE3	219,0	95,4	0,91	7,6
100-315L	2	160	315M	IE3	268,0	95,8	0,90	7,8
	2	200	315M	IE3	339,0	95,8	0,89	7,9

### MOTOR DATA 2900min<sup>-1</sup>

Model	Poles	kW	MEC	Efficiency	In A 400V	% Eff	PF (cos.f)	Is/In (400V)
125-200	2	37	200L	IE3	63,3	93,7	0,90	6,3
	2	45	225M	IE3	78,5	94,0	0,88	6,9
	2	55	250M	IE3	95,7	94,3	0,88	8,0
	2	75	280S	IE3	124,0	94,7	0,92	8,0
	2	90	280M	IE3	149,0	95,0	0,92	7,7
	2	110	315S	IE3	185,0	95,2	0,90	7,7
125-250L	2	75	280S	IE3	124,0	94,7	0,92	8,0
	2	90	280M	IE3	149,0	95,0	0,92	7,7
	2	110	315S	IE3	185,0	95,2	0,90	7,7
	2	132	315M	IE3	219,0	95,4	0,91	7,6
	2	160	315M	IE3	268,0	95,8	0,90	7,8
	2	200	315M	IE3	339,0	95,8	0,89	7,9
125-315	2	90	280M	IE3	149,0	95,0	0,92	7,7
	2	110	315S	IE3	185,0	95,2	0,90	7,7
	2	132	315M	IE3	219,0	95,4	0,91	7,6
	2	160	315M	IE3	268,0	95,8	0,90	7,8
	2	200	315M	IE3	339,0	95,8	0,89	7,9
150-200	2	37	200L	IE3	63,3	93,7	0,90	6,3
	2	45	225M	IE3	78,5	94,0	0,88	6,9
	2	55	250M	IE3	95,7	94,3	0,88	8,0
	2	75	280S	IE3	124,0	94,7	0,92	8,0
	2	90	280M	IE3	149,0	95,0	0,92	7,7
150-250	2	37	315S	IE3	63,3	93,7	0,90	6,3
	2	45	315M	IE3	78,5	94,0	0,88	6,9
	2	55	315M	IE3	95,7	94,3	0,88	8,0
	2	75	315M	IE3	124,0	94,7	0,92	8,0

### MOTOR DATA

1450min<sup>-1</sup>

Model	Poles	kW	MEC	Efficiency	In A		% Eff	PF (cos.f)	Is/In (400V)
					230V	400V			
32-125.1	4	0,37	71	-	1,8	1,0	72,7	0,71	4,3
	4	0,55	80	-	2,2	1,3	77,1	0,82	6,0
32-125	4	0,37	71	-	1,8	1,0	72,7	0,71	4,3
	4	0,55	80	-	2,2	1,3	77,1	0,82	6,0
32-160.1	4	0,75	80	IE3	2,8	1,6	82,5	0,81	6,7
	4	0,37	71	-	1,8	1,0	72,7	0,71	4,3
32-160	4	0,55	80	-	2,2	1,3	77,1	0,82	6,0
	4	0,75	80	IE3	2,8	1,6	82,5	0,81	6,7
32-200.1	4	0,37	71	-	1,8	1,0	72,7	0,71	4,3
	4	0,55	80	-	2,2	1,3	77,1	0,82	6,0
32-200	4	0,75	80	IE3	2,8	1,6	82,5	0,81	6,7
	4	1,1	90S	IE3	4,1	2,4	84,5	0,80	7,6
32-250	4	0,37	71	-	1,8	1,0	72,7	0,71	4,3
	4	0,55	80	-	2,2	1,3	77,1	0,82	6,0
40-125	4	0,75	80	IE3	2,8	1,6	82,5	0,81	6,7
	4	1,1	90S	IE3	4,1	2,4	84,5	0,80	7,6
40-160	4	1,5	90L	IE3	5,5	3,2	85,5	0,80	7,4
	4	0,37	71	-	1,8	1,0	72,7	0,71	4,3
40-200	4	0,55	80	-	2,2	1,3	77,1	0,82	6,0
	4	0,75	80	IE3	2,8	1,6	82,5	0,81	6,7
40-315	4	1,1	90S	IE3	4,1	2,4	84,5	0,80	7,6
	4	1,5	90L	IE3	5,5	3,2	85,5	0,80	7,4
50-125	4	2,2	100L	IE3	7,9	4,6	87,0	0,80	7,4
	4	3	100L	IE3	10,7	6,2	88,0	0,80	7,8
50-160	4	0,37	71	-	1,8	1,0	72,7	0,71	4,3
	4	0,55	80	-	2,2	1,3	77,1	0,82	6,0
50-200	4	0,75	80	IE3	2,8	1,6	82,5	0,81	6,7
	4	1,1	90S	IE3	4,1	2,4	84,5	0,80	7,6
50-250	4	1,5	90L	IE3	5,5	3,2	85,5	0,80	7,4
	4	2,2	100L	IE3	7,9	4,6	87,0	0,80	7,4
50-315	4	2,2	100L	IE3	7,9	4,6	87,0	0,80	7,4
	4	3	100L	IE3	10,7	6,2	88,0	0,80	7,8
50-125	4	4	112	IE3	13,9	8,0	88,8	0,81	7,0
	4	5,5	132S	IE3	-	10,4	89,7	0,85	8,2
50-160	4	7,5	132M	IE3	-	13,9	90,6	0,86	8,3
	4	0,37	71	IE2	1,78	1,03	72,7	0,71	4,3
50-200	4	0,55	80	IE2	2,18	1,26	77,1	0,82	6
	4	0,75	80	IE3	2,81	1,62	82,5	0,81	6,7
50-250	4	1,1	90S	IE3	4,07	2,35	84,5	0,8	7,6
	4	0,55	80	IE2	2,18	1,26	77,1	0,82	6
50-315	4	0,75	80	IE3	2,81	1,62	82,5	0,81	6,7
	4	1,1	90S	IE3	4,07	2,35	84,5	0,8	7,6
50-125	4	1,5	90L	IE3	5,49	3,17	85,5	0,8	7,4
	4	2,2	100L	IE3	7,91	4,56	87	0,8	7,4
50-160	4	3	100L	IE3	10,7	6,15	88	0,8	7,8
	4	4	112	IE3	13,9	8,03	88,8	0,81	7
50-200	4	1,5	90L	IE3	5,49	3,17	85,5	0,8	7,4
	4	2,2	100L	IE3	7,91	4,56	87	0,8	7,4
50-250	4	3	100L	IE3	10,7	6,15	88	0,8	7,8
	4	4	112	IE3	13,9	8,03	88,8	0,81	7
50-315	4	5,5	132S	IE3	-	10,4	89,7	0,85	8,2
	4	3	100L	IE3	10,7	6,15	88	0,8	7,8
50-125	4	4	112	IE3	13,9	8,03	88,8	0,81	7
	4	5,5	132M	IE3	-	10,4	89,7	0,85	8,2
50-160	4	7,5	132M	IE3	-	13,9	90,6	0,86	8,3
	4	11	160M	IE3	-	19,1	91,4	0,91	7,9

### MOTOR DATA 1450min<sup>-1</sup>

Model	Poles	kW	MEC	Efficiency	In A		% Eff	PF (cos.φ)	Is/In (400V)
					230V	400V			
65-125	4	0,55	80	-	2,2	1,3	77,1	0,82	6,0
	4	0,75	80	IE3	2,8	1,6	82,5	0,81	6,7
	4	1,1	90S	IE3	4,1	2,4	84,5	0,80	7,6
	4	1,5	90L	IE3	5,5	3,2	85,5	0,80	7,4
65-160	4	0,75	80	IE3	2,8	1,6	82,5	0,81	6,7
	4	1,1	90S	IE3	4,1	2,4	84,5	0,80	7,6
	4	1,5	90L	IE3	5,5	3,2	85,5	0,80	7,4
	4	2,2	100L	IE3	7,9	4,6	87,0	0,80	7,4
65-200	4	1,1	90S	IE3	4,1	2,4	84,5	0,80	7,6
	4	1,5	90L	IE3	5,5	3,2	85,5	0,80	7,4
	4	2,2	100L	IE3	7,9	4,6	87,0	0,80	7,4
	4	3	100L	IE3	10,7	6,2	88,0	0,80	7,8
	4	4	112	IE3	13,9	8,0	88,8	0,81	7,0
65-250	4	5,5	132S	IE3	-	10,4	89,7	0,85	8,2
	4	2,2	100L	IE3	7,9	4,6	87,0	0,80	7,4
	4	3	100L	IE3	10,7	6,2	88,0	0,80	7,8
	4	4	112	IE3	13,9	8,0	88,8	0,81	7,0
	4	5,5	132S	IE3	-	10,4	89,7	0,85	8,2
65-315	4	7,5	132M	IE3	-	13,9	90,6	0,86	8,3
	4	5,5	132S	IE3	-	10,4	89,7	0,85	8,2
	4	7,5	132M	IE3	-	13,9	90,6	0,86	8,3
	4	11	160M	IE3	-	19,1	91,4	0,91	7,9
100-160	4	15	160L	IE3	-	25,6	92,1	0,92	7,8
	4	2,2	100L	IE3	7,9	4,6	87,0	0,80	7,4
	4	3	100L	IE3	10,7	6,2	88,0	0,80	7,8
	4	4	112	IE3	13,9	8,0	88,8	0,81	7,0
100-200	4	5,5	132S	IE3	-	10,4	89,7	0,85	8,2
	4	2,2	100L	IE3	7,9	4,6	87,0	0,80	7,4
	4	3	100L	IE3	10,7	6,2	88,0	0,80	7,8
	4	4	112	IE3	13,9	8,0	88,8	0,81	7,0
	4	5,5	132S	IE3	-	10,4	89,7	0,85	8,2
100-250	4	7,5	132M	IE3	-	13,9	90,6	0,86	8,3
	4	11	160M	IE3	-	19,1	91,4	0,91	7,9
	4	15	160L	IE3	-	25,6	92,1	0,92	7,8
	4	4	112	IE3	13,9	8,0	88,8	0,81	7,0
	4	5,5	132S	IE3	-	10,4	89,7	0,85	8,2
100-315	4	7,5	132M	IE3	-	13,9	90,6	0,86	8,3
	4	11	160M	IE3	-	19,1	91,4	0,91	7,9
	4	15	160L	IE3	-	25,6	92,1	0,92	7,8
	4	11	160M	IE3	-	19,1	91,4	0,91	7,9
	4	15	160L	IE3	-	25,6	92,1	0,92	7,8
100-400	4	18,5	180M	IE3	-	33,2	92,6	0,87	7,8
	4	22	180L	IE3	-	38,4	93,0	0,89	7,5
	4	30	200L	IE3	-	52,6	93,6	0,88	7,9
	4	15	160L	IE3	-	25,6	92,1	0,92	7,8
	4	18,5	180M	IE3	-	33,2	92,6	0,87	7,8
100-400	4	22	180L	IE3	-	38,4	93,0	0,89	7,5
	4	30	200L	IE3	-	52,6	93,6	0,88	7,9
	4	37	225S	IE3	-	71,1	93,9	0,80	6,7
	4	45	225M	IE3	-	86,2	94,2	0,80	7,0
	4	30	200L	IE3	-	52,6	93,6	0,88	7,9

### MOTOR DATA

1450min<sup>-1</sup>

Model	Poles	kW	MEC	Efficiency	In A 400V	% Eff	PF (cos.f)	Is/In (400V)
125-200	4	7,5	132M	IE3	13,9	90,6	0,86	8,3
	4	11	160M	IE3	19,1	91,4	0,91	7,9
	4	15	160L	IE3	25,6	92,1	0,92	7,8
125-250	4	7,5	132M	IE3	13,9	90,6	0,86	8,3
	4	11	160M	IE3	19,1	91,4	0,91	7,9
	4	15	160L	IE3	25,6	92,1	0,92	7,8
	4	18,5	180M	IE3	33,2	92,6	0,87	7,8
	4	22	180L	IE3	38,4	93,0	0,89	7,5
	4	30	200L	IE3	52,6	93,6	0,88	7,9
125-315	4	15	160L	IE3	25,6	92,1	0,92	7,8
	4	18,5	180M	IE3	33,2	92,6	0,87	7,8
	4	22	180L	IE3	38,4	93,0	0,89	7,5
	4	30	200L	IE3	52,6	93,6	0,88	7,9
	4	37	225S	IE3	71,1	93,9	0,80	6,7
	4	45	225M	IE3	86,2	94,2	0,80	7,0
125-400	4	30	200L	IE3	52,6	93,6	0,88	7,9
	4	37	225S	IE3	71,1	93,9	0,80	6,7
	4	45	225M	IE3	86,2	94,2	0,80	7,0
	4	55	250M	IE3	95,4	94,6	0,88	7,4
	4	75	280S	IE3	125,0	95,0	0,91	7,5
125-500	4	37	225S	IE3	71,1	93,9	0,80	6,7
	4	45	225M	IE3	86,2	94,2	0,80	7,0
	4	55	250M	IE3	95,4	94,6	0,88	7,4
	4	75	280S	IE3	125,0	95,0	0,91	7,5
	4	90	280M	IE3	148,0	95,2	0,92	7,7
150-200	4	7,5	132M	IE3	13,9	90,6	0,86	8,3
	4	11	160M	IE3	19,1	91,4	0,91	7,9
	4	15	160L	IE3	25,6	92,1	0,92	7,8
	4	18,5	180M	IE3	33,2	92,6	0,87	7,8
150-250	4	15	160L	IE3	25,6	92,1	0,92	7,8
	4	18,5	180M	IE3	33,2	92,6	0,87	7,8
	4	22	180L	IE3	38,4	93,0	0,89	7,5
	4	30	200L	IE3	52,6	93,6	0,88	7,9
	4	37	225S	IE3	71,1	93,9	0,80	6,7
150-315	4	18,5	180M	IE3	33,2	92,6	0,87	7,8
	4	22	180L	IE3	38,4	93,0	0,89	7,5
	4	30	200L	IE3	52,6	93,6	0,88	7,9
	4	37	225S	IE3	71,1	93,9	0,80	6,7
	4	45	225M	IE3	86,2	94,2	0,80	7,0
	4	55	250M	IE3	95,4	94,6	0,88	7,4
	4	75	280S	IE3	125,0	95,0	0,91	7,5
150-400	4	45	225M	IE3	86,2	94,2	0,80	7,0
	4	55	250M	IE3	95,4	94,6	0,88	7,4
	4	75	280S	IE3	125,0	95,0	0,91	7,5
	4	90	280M	IE3	148,0	95,2	0,92	7,7
150-500	4	75	280S	IE3	125,0	95,0	0,91	7,5
	4	90	280M	IE3	148,0	95,2	0,92	7,7
	4	110	315S	IE3	185,0	95,4	0,90	7,8
	4	132	315M	IE3	219,0	95,6	0,91	7,8
	4	160	315L	IE3	265,0	95,8	0,91	7,9
200-400	4	75	280S	IE3	125,0	95,0	0,91	7,5
	4	90	280M	IE3	148,0	95,2	0,92	7,7
	4	110	315S	IE3	185,0	95,4	0,90	7,8
	4	132	315M	IE3	219,0	95,6	0,91	7,8
	4	160	315L	IE3	265,0	95,8	0,91	7,9
	4	200	315L	IE3	334,0	96,0	0,90	7,7
200-500	4	160	315L	IE3	265,0	95,8	0,91	7,9
	4	200	315L	IE3	334,0	96,0	0,90	7,7
	4	250	355L	IE3	422,0	96,0	0,89	7,9
	4	315	355L	IE3	526,0	96,0	0,90	7,8
	4	355	355L	IE3	622,0	95,8	0,86	6,9

### NOISE DATA

Motor power	MEC	50Hz	
		2900 mim <sup>-1</sup> (2 Poles)	1450 mim <sup>-1</sup> (4 Poles)
Overall Sound Pressure Level dB(A)			
0,37	71	56	44
0,55	80	59	44
0,75	80	59	44
1,1	90	62	49
1,5	90	62	49
2,2	100	67	53
3	100	67	53
4	112	64	56
5,5	132	67	56
7,5	132	67	56
11	160	75	67
15	160	75	67
18,5	180	75	67
22	180	75	67
30	200	75	70
37	225	75	70
45	225	75	70
55	250	77	70
75	280	78	73
90	280	78	73
110	315	80	77
132	315	80	77
160	315	80	77
200	315	80	77
250	355	86	84
315	355	86	84
355	355	86	84

## INTERCHANGEABILITY CHART

Model	Shaft No.	Impeller	Ball Bearing	Deflector	Case Wear Ring (front side)	Case Wear Ring (back side)	O Ring (for casing)	Mechanical Seal version	Gland Packing version		
									Shaft Sleeve	Sleeve Gasket	Gland Packing
GS 32-125.1	230	Depends on each models	A	A	A	A	A	A	A	A	A
GS 32-125	230		A	A	A	A	A	A	A	A	A
GS 32-160.1	230		A	A	A	A	A	A	A	A	A
GS 32-160	230		A	A	A	A	A	A	A	A	A
GS 32-200.1	230		A	A	A	A	B	A	A	A	A
GS 32-200	230		A	A	A	A	B	A	A	A	A
GS 32-250	230		A	A	A	A	C	A	A	A	A
GS 40-125	230		A	A	B	B	A	A	A	A	A
GS 40-160	230		A	A	B	B	A	A	A	A	A
GS 40-200	230		A	A	B	B	B	A	A	A	A
GS 40-250	230		A	A	B	B	C	A	A	A	A
GS 40-315	240		B	B	C	C	D	B	B	B	B
GS 50-125	230		A	A	C	C	A	A	A	A	A
GS 50-160	230		A	A	C	C	A	A	A	A	A
GS 50-200	230		A	A	C	C	B	A	A	A	A
GS 50-250	230		A	A	C	C	C	A	A	A	A
GS 50-315	240		B	B	D	D	D	B	B	B	B
GS 65-125	230		A	A	D	D	A	A	A	A	A
GS 65-160	230		A	A	D	D	A	A	A	A	A
GS 65-200	230		A	A	D	D	B	A	A	A	A
GS 65-250	240		B	B	D	D	C	B	B	B	B
GS 65-315	240		B	B	E	E	D	B	B	B	B
GS 80-160	230		A	A	E	E	A	A	A	A	A
GS 80-200	240		B	B	E	E	B	B	B	B	B
GS 80-250	240		B	B	F	F	C	B	B	B	B
GS 80-315	240		B	B	F	F	D	B	B	B	B
GS 80-315L	250		C	C	F	F	D	C	C	C	C
GS 80-400	250		C	C	F	F	E	C	C	C	C
GS 100-160	240		B	B	F	G	A	B	B	B	B
GS 100-200	240		B	B	H	H	B	B	B	B	B
GS 100-250	240		B	B	H	H	C	B	B	B	B
GS 100-315	240		B	B	H	I	D	B	B	B	B
GS 100-315L	250		C	C	H	I	D	C	C	C	C
GS 100-400	250		C	C	J	J	E	C	C	C	C
GS 125-200	240		B	B	J	H	B	B	B	B	B
GS 125-250	240		B	B	K	J	C	B	B	B	B
GS 125-250L	250		C	C	K	K	C	C	C	C	C
GS 125-315	250		C	C	L	K	D	C	C	C	C
GS 125-400	250		C	C	L	L	E	C	C	C	C
GS 125-500	260		D	D	M	M	F	D	D	D	D
GS 150-200	240	B	B	K	I	B	B	B	B	B	
GS 150-250	250	C	C	N	N	C	C	C	C	C	
GS 150-315	250	C	C	N	N	D	C	C	C	C	
GS 150-400	250	C	C	O	O	E	C	C	C	C	
GS 150-500	270	E	E	P	P	F	E	E	E	E	
GS 200-400	270	E	E	Q	Q	E	E	E	E	E	
GS 200-500	280	F	F	Q	Q	F	F	F	F	F	

Materials of every components is specified in the section of "Materials of Construction".  
The same letter in the same vertical column means component is interchangeable.









**Japanese Technology since 1912**

**[www.ebara-europe.com](http://www.ebara-europe.com)**



**EBARA Pumps Europe S.p.A.**

Via Torri di Confine 2/1 int. C  
36053 Gambellara (Vicenza), Italia  
Tel. +39 0444 706811  
Fax +39 0444 405811  
ebara\_pumps@ebaraeurope.com  
www.ebaraeurope.com

**EBARA Corporation**

11-1, Haneda Asahi-cho, Ohta-ku,  
Tokyo 144-8510  
Japan  
Tel +81 3 6275 7598  
Fax +81 3 5736 3193  
www.ebara.com

