

HEBEFIX 200

ABOVE FLOOR TANK



- Single- or duplex unit
- Odour-tight cover
- Guide rail system GR 32 or GR 50 possible

DESCRIPTION

The Hebefix 200 is available for bigger domestic wastewater volume and larger storage capacity. Without requiring a great deal of construction work, it disposes of domestic wastewater from laundries, storage or cellar areas.

The Hebefix 200 can be installed as a single as well as duplex system. The required components for the installation of the pump are part of the scope of supply. The duplex system provides bigger security in the disposal of wastewater. In normal operation the two pumps operate alternately or at the same time to cope with peak load. The control unit operates the duplex system depending on the type of pump (see accessories).

If the system is to be operated as a single system, a pump with a built-in level control must be selected.

The pump to be placed can be selected according to the amount of wastewater. The dirty water to be transported and the pumping power required have to be taken into consideration in particular. In case of slightly dirty water, pumps U3K, U5K as well as U6K E+D can be used. If the admixtures are larger or the volume of wastewater is bigger, the use of a pump of the US series is recommendable. Pumps US 73+103 Ex are used in hazardous areas. In case of commercial applications, the resistance of the materials have to be tested in advance. Depending on the type of pump used, the Hebefix 200-32 with 1/4" or the Hebefix 200-50 with 2" discharge branch has to be chosen.

The unit is in conformity with the specification of German / European standard EN 12050.

Specifications can be changed without notice. Performance subject to ISO 9906 tolerances.

PERFORMANCE

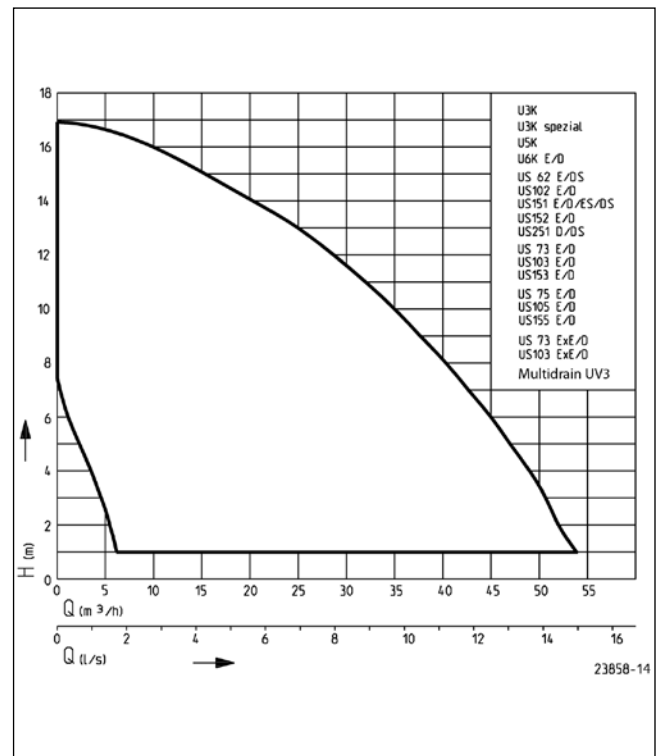

HEBEFIX 200

ABOVE FLOOR TANK

SCOPE OF SUPPLY

Plastic tank to house a pump tested in keeping with German / European standard EN 12050, shaped connecting piece, cover

and seal, hose connection and pressure pipe, two swing-type check valves, plug for cable conduit, without pumps.

MECHANICAL DATA

Tank capacity	240 l
---------------	-------

HEBEFIX 200

Type	Code No.	Weight
Hebefix 200-32	JP48188	26 kg
Hebefix 200-50	JP48189	29 kg

POSSIBLE PUMPS

Hebefix 200-32	US 103 E/D Ex	US 103 E/D
U3K/U3K spezial	Multidrain UV3	US 153 E/D
U5K	Hebefix 200-50	US 75 E/D
U6K E/D	US 62 E/D	US 105 E/D
US 62 E/D	US 102 E/D	US 155 E/D
US 102 E/D	US 151 E/D	US 73 E/D Ex
US 73 E/D	US 152 E/D	US 103 E/D Ex
US 103 E/D	US 251 D	
US 73 E/D Ex	US 73 E/D	



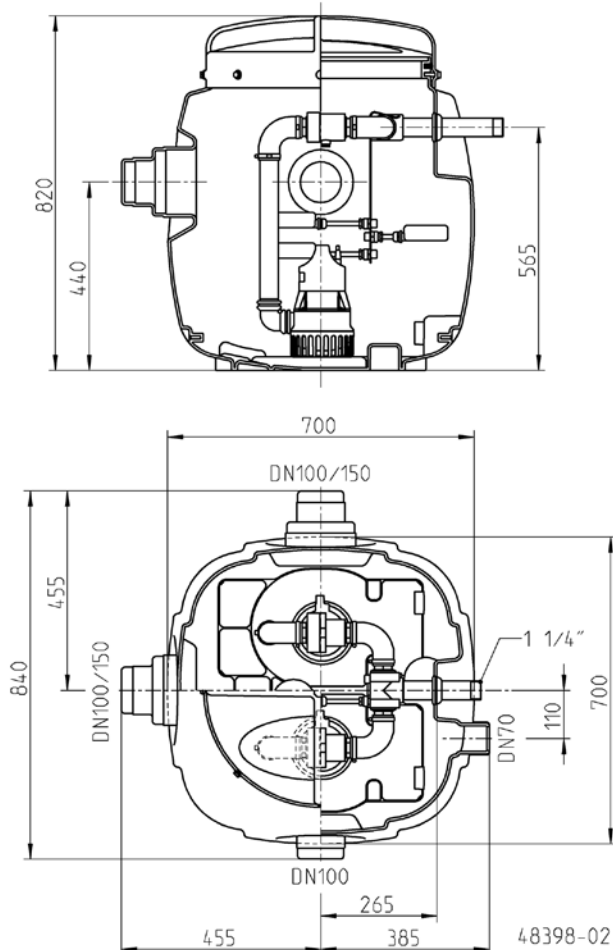

Dimensions Hebefix 200-32 (mm)



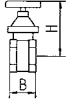

HEBEFIX 200

ABOVE FLOOR TANK

MECHANICAL ACCESSORY

				Code No.
	① Stop valve	1¼" (DN 32), PN 16	110x60 (HxB)	JP44785
		brass, 1½" (DN 40), PN 16	125x60 (HxB)	JP44786
		brass, 2" (DN 50), PN 16	140x70 (HxB)	JP44787
	Ball valve	1¼", PVC, for aggressive media	105x155 (HxB)	JP46111
	② Special ventilation	special filter with housing, not for hot water		JP27484
	③ Guide rail system	Guide rail system GR32 for Hebefix 200/Baufix 200 (U3/U5/U5)		JP48279
		Guide rail system GR50 for Hebefix 200/Baufix 200 (US75/US105/US155)		JP48280
	Securing levers	for US 75, US 105, US 155, Vacubox, stainless steel		JP41024

ELECTRICAL ACCESSORY

				Code No.
	a Control for duplex units	Control unit HIGHLOGO 2-00 E	230 V	JP47996
		Control unit BD 00 E	230 V, for pumps U3-U6, US 62-105, UV3, UV 300, 08/2 ME	JP45735
		Control unit HIGHLOGO 2-00	400 V	JP47997
		Control unit BD 00	400 V, for pumps U6, US 62-105, UV 300	JP45993
		Control unit HIGHLOGO 2-25	400 V	JP47998
		Control unit BD 25	400 V, for pumps US 151-155	JP45737
		Control unit BD 610 EC	230 V, with operating capacitor	JP45743
		Control unit BD 46	400 V, for pumps US 251-253, UV 620-3, UV 625-3	JP45739
		Control unit BD 23 X	for US 73 D EX	JP09755
		Control unit BD 25 X	for US 103 D EX	JP09681
			Level control	
	Dry run protection			JP44603
	Submersible switch pack B232	for Hebefix 200-32 / Baufix 200-32		JP48228
	Submersible switch pack B250	for Hebefix 200-50 / Baufix 200-50 / Vacubox 200		JP48229
	Submersible switch pack BF232	for grease-containing wastewater		JP48298
	Submersible switch pack BF250	for grease-containing wastewater		JP48299
	Auxiliary switch unit ExH-B for explosion-proof pumps only			JP00295
	Alarm unit			
	AG3	subm. ball contact switch, mains dependent, potential-free contact, 3 m cable		JP44891
	AG10	subm. ball contact switch, mains dependent, potential-free contact, 9.5 m cable		JP44892
	Washing machine stop			
	AW3	subm. ball contact switch, mains dependent, 3 m cable		JP44895
	AW0	for alarm forwarding in case of several washing machines		JP44899
	b Rechargeable battery	for mains independent alarm		JP44850
	c Seal leak detector	DKG		JP44900
		DKG Ex for explosion-proof pumps		JP00249