

# PUMPS FOR WASTEWATER TREATMENT



SUBMERSIBLE SEWAGE PUMPS

M(X), MXS, V(X), K(X) series | Discharge connector DN 80 - DN 150





## HOMA: QUALITY PRODUCTS FOR WASTE WATER SYSTEMS

### HIGH EFFICIENCY AND ECONOMIC VIABILITY

Submersible pumps from HOMA have been in use around the world for decades. Requirements for the waste water sector are constantly increasing. HOMA products go beyond state of the art – through the continual optimisation of their hydraulic components and motors, they ensure economic operation and an affordable purchase price. All of the company's expertise and creative potential have been incorporated into its products and services – for maximum customer benefit.

### INDIVIDUAL POSSIBILITIES, OPTIMUM SOLUTIONS

HOMA unites safety, economic viability, high quality and robust system technology with customisation options: the product spectrum ranges from complete pump stations with pumps, valves, pipework, pre-assembled concrete or plastic sumps, through to electronic control systems. The focus is on optimum design with cost effective workflows on site for all installation types.

### HIGHER FUNCTIONAL RELIABILITY, LOWER ENERGY CONSUMPTION

With HOMA you are always in good hands – our pump stations are controlled and monitored fully automatically, and faults are registered automatically, too. The pumps run with the lowest possible energy consumption, which is also ensured by optimally matched water level control devices, such as floats, pneumatics, ultrasound and hydrostatic level sensors (ENS sensors).

In many cases, both the pump and control system have to meet the relevant requirements and regulations on explosion protection. All HOMA pumps are therefore also available as explosion-proof versions.



Each unit is tested in the modern test center before delivery. This is how we guarantee HOMA's renowned quality standards.



For chemically aggressive liquids: Stainless steel submersible pumps of HOMA.

## PROVEN TECHNOLOGY FOR A BROAD RANGE OF APPLICATIONS

### MULTIPLE DEMANDS – INDIVIDUAL SOLUTIONS

Submersible waste water pumps from HOMA convey domestic, public and industrial waste water, sewage (containing faeces), and sludge (which may contain high levels of solid and fibrous matter), as well as domestic waste water of any kind. Thanks to the use of a broad range of materials (stainless steel in different grades, bronze, Viton, etc.), HOMA submersible pumps are suitable for a wide variety of industrial applications.

- Industrial waste water
- Sewage treatment plants
- Large scale pump stations
- Industrial applications
- Oil and gas
- Power station construction
- Mining
- Chemical processes
- Shipbuilding/offshore sector

### MORE POWER FOR EVERY REQUIREMENT

HOMA pumps are used in all manner of applications: to supply water to power stations, as seepage pumps in coal mines, drainage pumps in infrastructure projects, waste water pumps for industrial waste water, or as ballast pumps in the shipbuilding and marine sector. Customers benefit from proven features tried and tested in real life applications, such as:

- A range of different impellers, depending on the medium being conveyed, e.g. special symmetries, hardened materials and ceramic coatings
- Motors suitable for continuous operation, with or without cooling jackets
- High grade materials
- Robust construction



## FOR GREATER SAFETY AND DURABILITY

### MORE BENEFITS IN ALL OPERATING MODES

For operating mode S1 (continuous operation), the motors are designed with a maximum switching frequency of 15 operating cycles per hour. In addition to the standard version for operation with a submerged motor, a special version with cooling jacket is also available for use with a surface motor or dry installed motor.

Hydraulics with single-channel impellers are suitable for intermittent operation (i.e. generally for level-controlled automatic sump operation) and continuous operation. Vortex or multi-channel impellers are the right choice for continuous operation in particular, e.g. for industrial service water supply.

### TOP MATERIAL QUALITY – LOWER SUSCEPTIBILITY TO FAILURE

Quality is a measurable value – fully floodable pump blocks from HOMA impress through their generous sizing of all important components, with outstanding material quality and solid mechanical workmanship. This guarantees a long service life



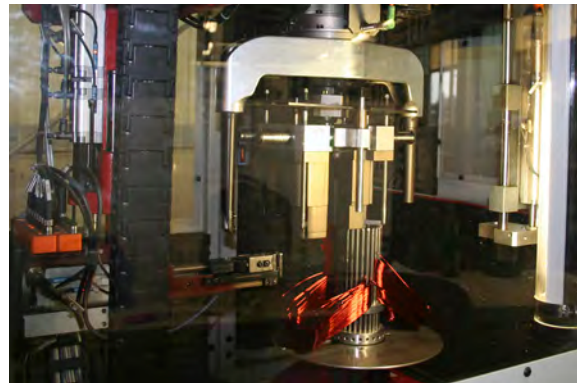

In-house motor production allows various voltages and frequencies

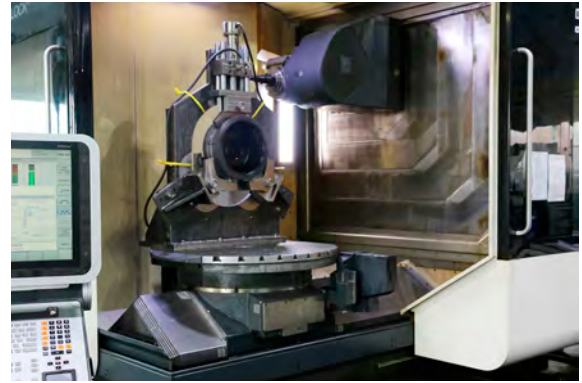

By machining all needed components in our own workshop on modern precision equipment we are able to assure efficiency and flexibility.

## DIFFERENT INSTALLATION TYPES ALLOW GREATER EASE OF SERVICE

### STATIONARY WET WELL INSTALLATION

The pump is connected to the pressure pipe and is made pressure-tight by means of a coupling base attached to the bottom of the sump. For maintenance or repair, it can be removed from its operating position from above through the sump opening via a permanently installed double pipe feed. The pump is attached and detached automatically; it is not necessary to enter the sump. With its flexible rubber gasket, the HOMA coupling system thereby ensures a secure, permanent, leak-free seal between the pump and the pressure pipe.

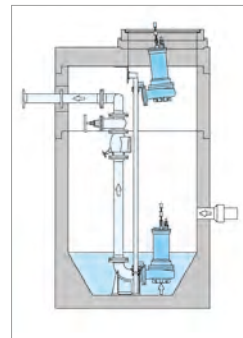

Permanent wet well installation

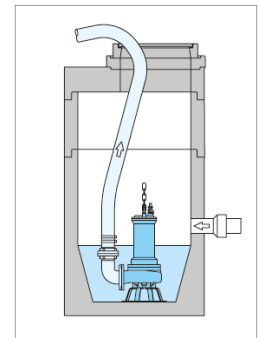

Transportable wet well installation

### MOBILE WET WELL INSTALLATION

Universal installation for immersion in trenches and sumps, for use over a limited period, emergency operation or service operation. Can be used with a pressure hose or pressure pipe.

### STATIONARY DRY INSTALLATION – VERTICAL OR HORIZONTAL

Flood-proof installation for pump stations with a separate collection sump. Flange connection for suction pipe and pressure pipe.

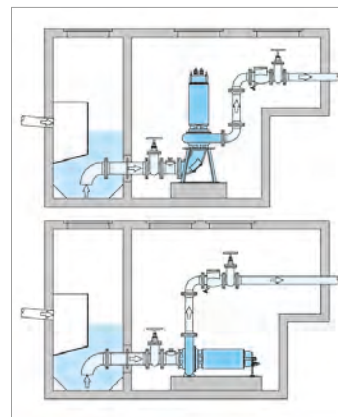

Permanent dry well installation



## EFFTEC MOTORS AND MXS HYDRAULICS

### MXS: IMMUNITY TO CLOGGING

Conveyed media have changed greatly in recent years, displaying an increasing solids content. In order to ensure reliable operation in such cases, our new MXS hydraulics rely on closed single-vane impellers with large free passages.

Our impellers and pump housings have been redesigned at the HOMA R&D center and optimized with the latest flow-simulation software. The result: clearly improved hydraulic efficiencies of up to 81 percent, with a simultaneously low risk of blockage and quiet running. In combination with HOMA's proven submersible-motors, the new MXS hydraulics are setting a trend in economic efficiency and operational safety.

### EFFTEC: INNOVATIVE TECHNOLOGY

In order to achieve the highest possible overall efficiency with consequently low energy consumption we developed the new EffTec series at our HOMA R&D center. In combination with the new MXS hydraulics, the new pump generation is setting a trend in economic efficiency and operational safety.

The newly developed PermaCool system is future-oriented. This permanent motor cooling now gives you the option of fitting the units for submerged or drywell installation. The new design - registered for a patent - simultaneously ensures that the cooling jacket cannot be clogged with solids.

Together with the low winding temperature of the EffTec motors, the PermaCool system puts a low thermal load on all components, thus ensuring their long useful lifetime.

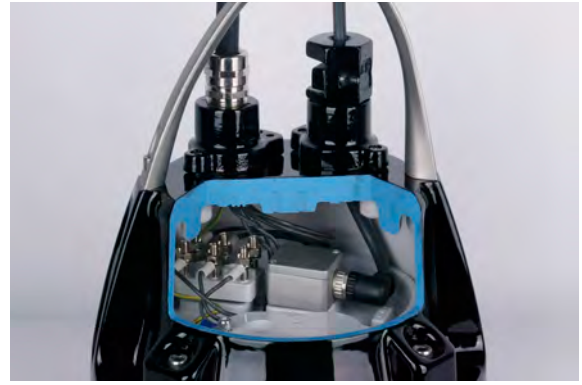
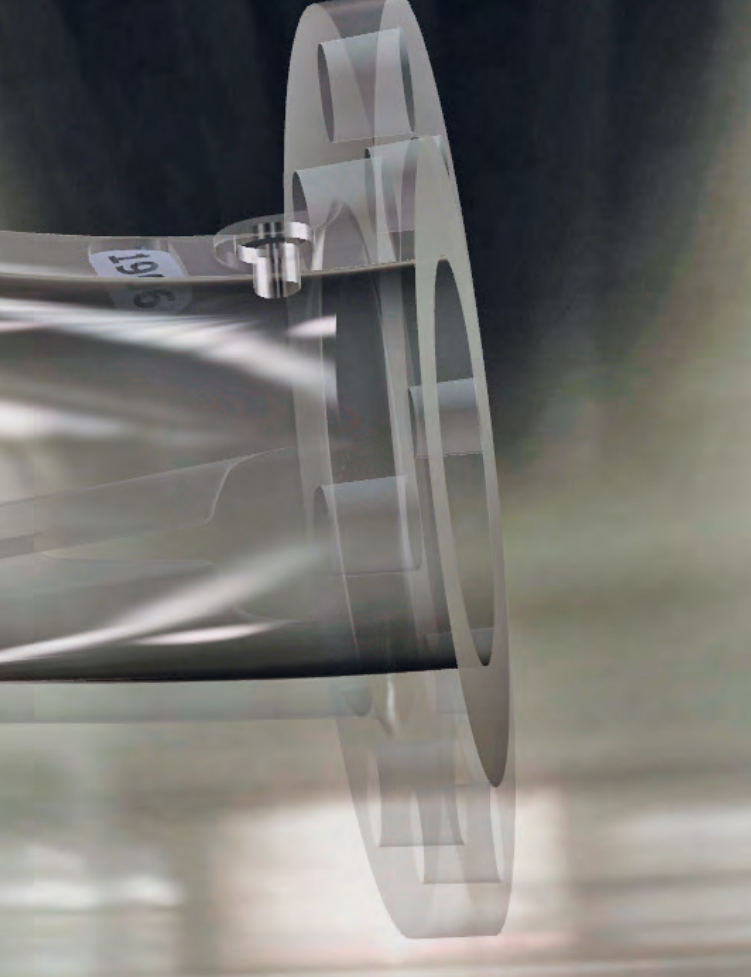

Reliable Monitoring - the integrated pump vibration diagnostic system HOMA VICON



Optionally available with connection for automatic HOMA FV flush valve.

## THE HIGH PRESSURE CLEANING DEVICE FOR THE PUMP SUMP

### VICON: ENSURING A LONG PUMP SERVICE LIFE

Status monitoring of electrical machines is of considerable importance where quality, reliability, energy savings and targeted repair play a significant role. Submersible pumps are a special case since they are immersed in the medium being handled. Carrying out repair and maintenance is often extremely difficult. Furthermore, high reliability without pump downtimes is essential. With HOMA VICON, the pump and system are constantly and reliably monitored, and any faults or damage are detected at an early stage.

For example, HOMA VICON registers any blockage or damage to the hydraulics, unfavourable or defective operating points, and bearing damage or pipework problems, and indicates these issues or, if necessary, switches the pump off. By optimising the system and detecting adverse operating conditions in good time, HOMA VICON helps to save energy and reduce lifecycle costs.

### FLUSH VALVES: KEEPING IT CLEAN

Pump stations require frequent cleaning as solids settle at the bottom or a layer of floating matter gathers on the surface of the water. Expensive cleaning and maintenance measures as well as high costs due to downtimes can arise. HOMA has the answer: the new HOMA FV 25 and FV50 flush valves reliably prevent deposits in pump sumps. At the beginning of the pumping process, part of the medium being handled is channelled back to the pump sump through the open flush valve. As the medium is flushed through the sump, it stirs up deposited solids so that they can be removed.

The flushing nozzle can either be directed towards the bottom of the pump sump to remove deposits, or alternatively, towards the surface of the waste water to prevent the formation of a layer of floating matter, especially in the case of waste water with a high fat content.



## RANGES AND PUMP TYPES

### MOTOR SELECTION

#### Speed:

For the standard hydraulic range, the motors are designed with the following speeds.

- 2900 rpm = 2-pole
- 1450 rpm = 4-pole
- 960 rpm = 6-pole

#### Voltages:

All specified data relate to an operating voltage of 400V/3 Ph, 50 Hz. Different voltages are available on request.

#### Type of starting:

The motors are supplied as standard:

- up to 3,5 kW (P2) for DOL starting
- above 3,5 kW (P2) for DOL and star-delta starting

On request all motors are available for operating with frequency converter or soft starter device.

#### Explosion protection:

In addition to the standard version, selected motors are also available explosion proof according to ATEX EX II 2 G Ex c d II B T4,(T3).

#### Dry well variant:

Besides the version for submerged operation, all pumps are also available with cooling jacket for dry well or non-submerged operation.

#### Motor monitoring:

All motors are supplied with temperature sensors in the winding, bi-metallic sensors (standard) or PTC sensors (on request).

Additional monitoring devices (bearing temperature, stator room moisture) on request.



# PUMP TYPE CODE

Range	Impeller	Discharge	Spherical clearance	Impeller diameter	Motor frame size	Jacket cooled	Motor power (coded)	Speed	Monitoring	Explosion protection
<b>Pump</b>					<b>Motor</b>					
	<b>MXS</b>	<b>2</b>	<b>4</b>	<b>48-</b>	<b>T</b>	<b>(U)</b>	<b>6</b>	<b>4</b>	<b>(C)+(S)</b>	<b>(EX)</b>
	MX(S) Enclosed single channel impeller  V(X) Vortex-Impeller  K(X) Enclosed multi channel	1 = 80 mm 2 = 100 mm 3 = 150 mm	( mm : 25 ) 3 = 80 mm 4 = 100 mm	( mm : 5 ) e.g. 48 = 240 mm	C, D, T, P, F, G  ET: EffTec-Motor with PermaCool-System for wet- and dry well installation	Motor with cooling jacket  U= open circuit pumped liquid cooling		2 = 2pole (2900 rpm) 4 = 4pole (1450 rpm) 6 = 6pole (960 rpm)	C = Oil chamber seal condition monitoring probe  S = moisture sensor in stator chamber	

## RANGES AND HYDRAULICS

### HYDRAULIC SELECTION

#### Discharge and suction flange

- DN 80
- DN 100
- DN 150

Reducing adapters for different auto-coupling system and valve dimensions are available.

#### Impeller:

A range of different impeller designs are available to provide optimum performance and reliability with various liquids and operating conditions.

#### Impeller spherical clearance:

The pumps are available with impeller spherical clearances from 80 mm to 100 mm according to pump range.



**MX(S)**  
**Enclosed single channel impeller**

For liquids containing impurities and sludge with solid particles or long fibers. New generation of non clogging impellers with hydraulic efficiency over 80%.



**K(X)**  
**Enclosed Multi Channel Impeller**

For liquids containing impurities and sludge with solid particles.



**V(X)**  
**Vortex impeller**

For liquids containing a high level of impurities or fibrous matter and containing gas.



# SUPERIOR MATERIAL QUALITY – LOWER SUSCEPTIBILITY TO FAILURE

Quality can be measured – HOMA submersible waste water pumps are characterized by the robust design, generous dimensioning and high quality materials of all components.

## 1 DISCHARGE

With DIN/ANSI flange DN 80, DN 100 or DN 150 (PN 10)

## 2 NON-CLOGGING IMPELLERS

- Enclosed single channel impeller with replaceable wear ring
- Enclosed multi channel impeller with replaceable wear ring
- Vortex impeller

## 3 SHAFT SEALS

Two independently working silicon-carbide mechanical seals in tandem-arrangement.

## 4 OIL CHAMBER (MODEL „C“)

Separate large oil chamber, lubricating and cooling the mechanical seals, forming an extra safety and inspection element.

## 5 MOTOR

Three phase electric motor with 2-, 4- or 6-pole winding. Insulation class H (180° C), Protection IP 68.

## EXPLOSION PROTECTION

In addition to the standard version, selected motors are also available explosion proof according to ATEX EX II 2 G Ex c d II B T4,(T3).

## 6 MOTOR COOLING

Motors for submerged operation are cooled by the surrounding liquid. For dry well or non-submerged operation, motors are available with a cooling jacket, providing a cooling circulation of water from the pump volute (model U).

## 7 THERMAL SENSOR (BI-METAL)

Embedded in the motor winding. PTC sensors available on request.

## 8 MOISTURE MONITORING IN STATOR CHAMBER (MODEL „S“)

Available on request.

## 9 SHAFT BEARING

Maintenance-free, pre-lubricated ball bearings.

## 10 TEMPERATURE MONITORING OF THE SHAFT BEARINGS

On request.

## 11 CABLE JUNCTION CHAMBER

Separate junction chamber standard from 22 kW 4-pole, below on request.

## 12 ELECTRONIC MOISTURE SENSOR IN JUNCTION CHAMBER

Available on request.

## 13 HOMA VICON - PUMP VIBRATION DIAGNOSTIC SYSTEMS

HOMA VICON can detect an obstruction or damage to the hydraulics, unfavorable or defective operation points, bearing damages or conduit problems, it displays these or stops the pump in the case of emergency.

## 14 PRESSURE SEALED, STRAIN RELIEF CABLE ENTRY

# MATERIALS

Motor housing	Cast iron EN-GJL-250 <sup>1)</sup>
Pump housing	Cast iron EN-GJL-250 <sup>1)</sup>
Impeller	Cast iron EN-GJL-250 <sup>1) 2)</sup>
Wear rings	Bronze <sup>1)</sup>
Motor shaft	Stainless steel
Mechanical seals	Silicon-carbide / Silicon-carbide
Motor cooling jacket (model U and L)	Stainless steel
Seals and O-rings	NBR (Perbonane) <sup>3)</sup>
Cable	H07RN-F (Plus) <sup>4)</sup>

<sup>1)</sup> also available in stainless steel

<sup>2)</sup> also available in bronze

<sup>3)</sup> also available from FPM (vitone)

<sup>4)</sup> screened cable on request

# NEW EFFTEC-MOTORS: INNOVATIVE TECHNOLOGY - GREAT EFFICIENCY

**EFFTEC**  
SUPERIOR EFFICIENCY - SUPERIOR PERFORMANCE

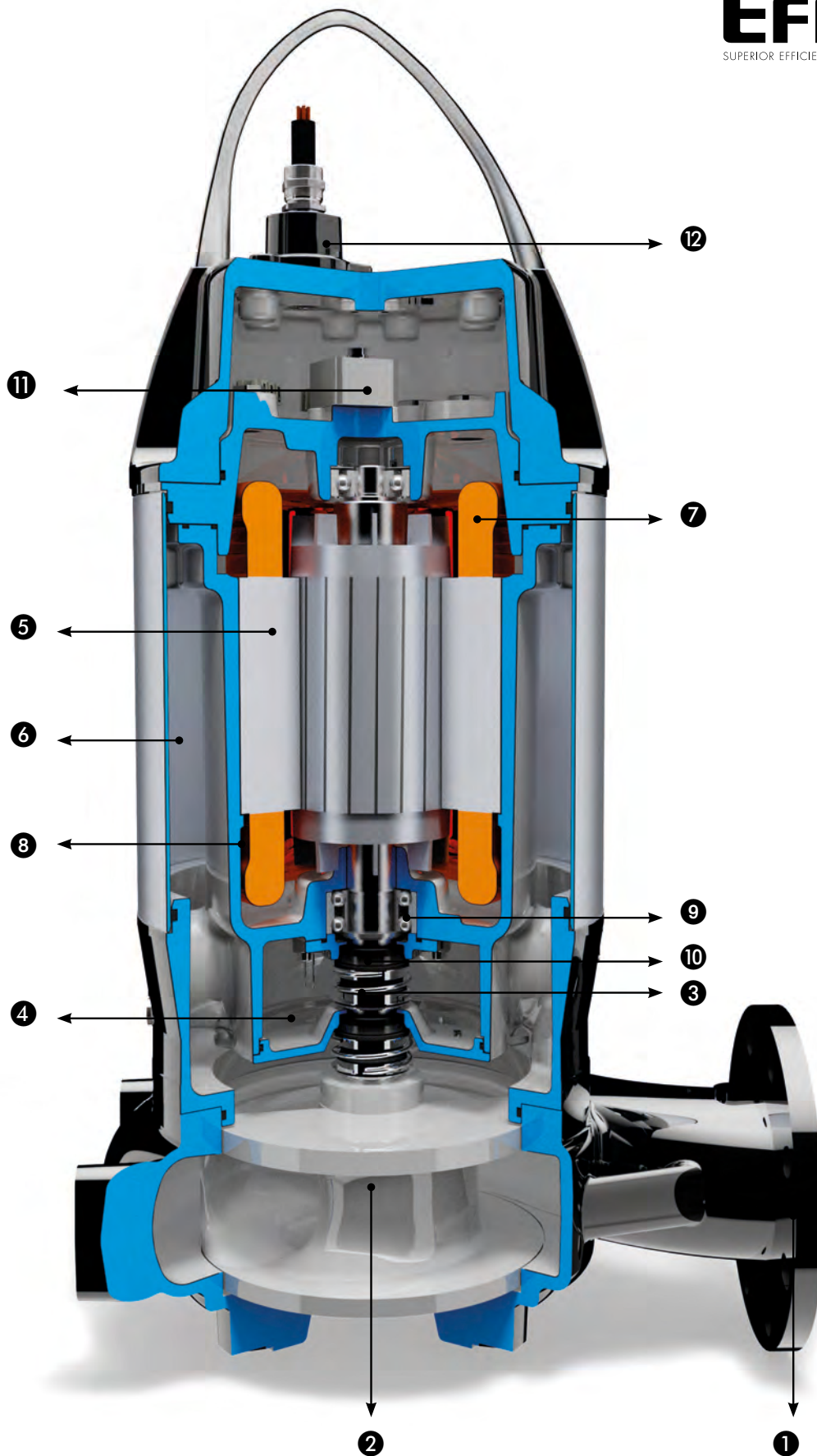

Illustration: ET-Motor with MXS-Hydraulics

# PERMANENT MOTOR COOLING: PERMACOOL®

All models in the EffTec series are equipped with the newly developed PermaCool system. This permanent motor cooling now gives you the option of fitting the units for submerged or drywell installation. The new design - registered for a patent - simultaneously ensures that the cooling jacket cannot be clogged with solids. In combination with our new MXS-hydraulics, the new EffTec series of pumps sets a trend for economic efficiency and reliability.

## 1 DISCHARGE

With DIN/ANSI flange DN 80, DN 100 or DN 150 (PN 10).

## 2 NON-CLOGGING IMPELLERS

- Enclosed single channel impeller with large spherical clearance. Replaceable wear ring.
- Vortex impeller.

## 3 SHAFT SEALS

Two independently working silicon-carbide mechanical seals in tandem-arrangement.

## 4 OIL CHAMBER

Oil-filled seal chamber with possibility of control by the inspection screw.

## 5 MOTOR

Three phase electric motor with 2-, 4-, or 6-pole winding. Insulation class H (180 C), Protection IP 68.

## EXPLOSION PROTECTION

In addition to the standard version, selected motors are also available explosion proof according to ATEX EX II 2 G Ex c d II B T4,(T3).

## 6 MOTOR COOLING PERMACOOL

This permanent motor cooling now gives you the option of fitting the units for submerged or drywell installation.



The new innovative PermaCool motor cooling

Together with the low winding temperature of the EffTec motors, the PermaCool system puts a low thermal load on all components, thus ensuring their long useful lifetime.

## 7 THERMAL SENSOR (BI-METAL)

Embedded in the motor winding. PTC sensors available on request.

## 8 MOISTURE MONITORING IN STATOR CHAMBER

On request.

## 9 SHAFT BEARING

Maintenance-free, prelubricated ball bearings.

## 10 TEMPERATURE MONITORING OF THE SHAFT BEARINGS

On request.

## 11 HOMA VICON - PUMP VIBRATION DIAGNOSTIC SYSTEMS

HOMA VICON can detect an obstruction or damage to the hydraulics, unfavorable or defective operation points, bearing damages or conduit problems, it displays these or stops the pump in the case of emergency.

## 12 PRESSURE SEALED, STRAIN RELIEF CABLE ENTRY

## MATERIALS

Motor housing	Cast Iron EN-GJL-250 <sup>1)</sup>
Pump housing	Cast Iron EN-GJL-250 <sup>1)</sup>
Impeller	Cast Iron EN-GJL-250 <sup>1) 2)</sup>
Wear ring	Bronze <sup>1)</sup>
Motor shaft	Stainless Steel
Mechanical seals	Siliziumkarbide / Siliziumkarbide
Cooling jacket	Stainless Steel
Seals / O-Rings	NBR (Perbunan) <sup>3)</sup>
Cable	H07RN-F PLUS <sup>4)</sup>

<sup>1)</sup> also available in stainless steel <sup>2)</sup> also available in bronze  
<sup>3)</sup> also from FPM (vitone) <sup>4)</sup> screened cable on request

# DN 80 - PUMP RANGES SELECTION CHART

## DN 80

Enclosed single channel impeller  
80 mm Ø  
Spherical clearance  
2900 rpm



PAGE 18

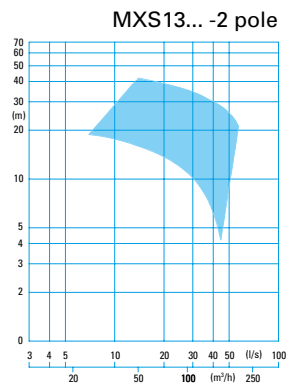

## DN 80

Enclosed single channel impeller  
80 mm Ø  
Spherical clearance  
1450 rpm



PAGE 19

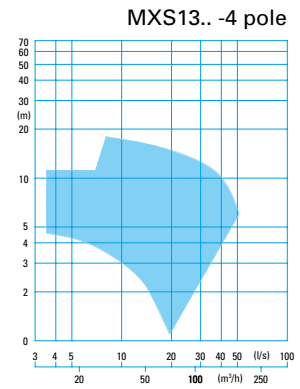

## DN 80

Enclosed single channel impeller  
80 mm Ø  
Spherical clearance  
960 rpm



PAGE 20

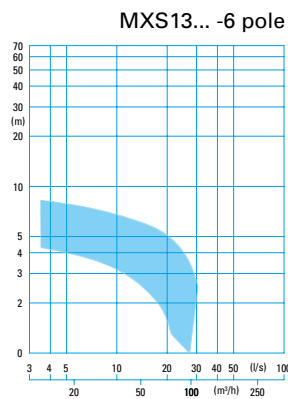

## DN 80

Vortex impeller  
80 mm Ø  
Spherical clearance  
2900 rpm



PAGE 21

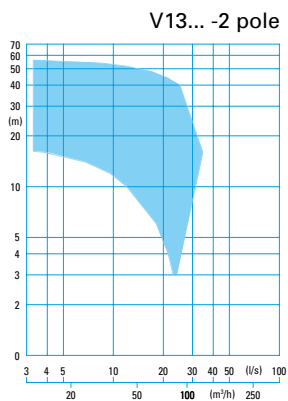

## DN 80

Vortex impeller  
80 mm Ø  
Spherical clearance  
1450 rpm



PAGE 22

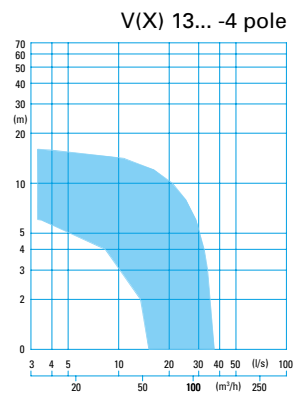

# DN 100 - PUMP RANGES SELECTION CHART

## DN 100

Enclosed single channel impeller  
80 mm Ø  
Spherical clearance  
2900 rpm



PAGE 23

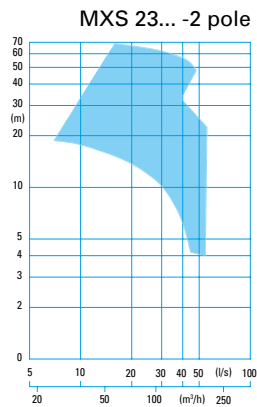

## DN 100

Enclosed single channel impeller  
80 mm Ø  
Spherical clearance  
1450 rpm



PAGE 24

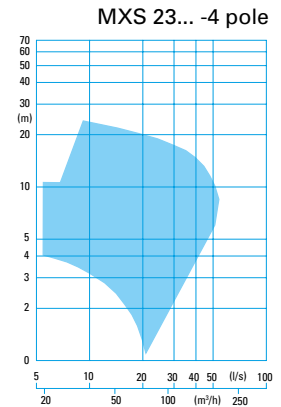

## DN 100

Vortex impeller  
80 mm Ø  
Spherical clearance  
2900 rpm



PAGE 25

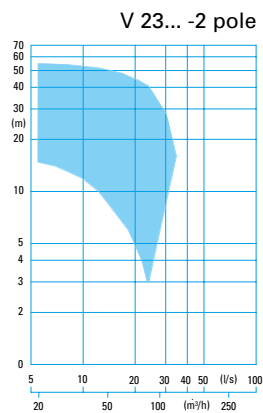

## DN 100

Vortex impeller  
80 mm Ø  
Spherical clearance  
1450 rpm



PAGE 26

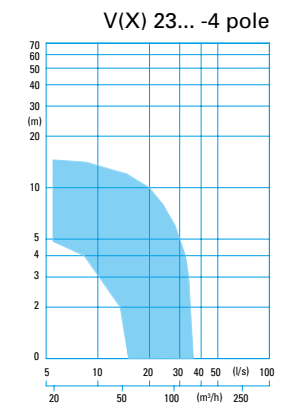

## DN 100

Enclosed two channel impeller  
80 mm Ø  
Spherical clearance  
1450 rpm



PAGE 27

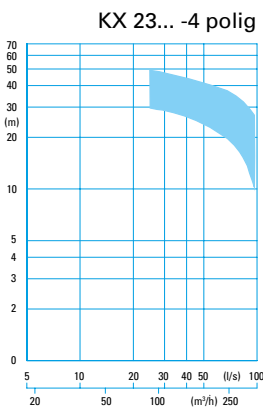

## DN 100

Enclosed single channel impeller  
100 mm Ø  
Spherical clearance  
1450 rpm



PAGE 28

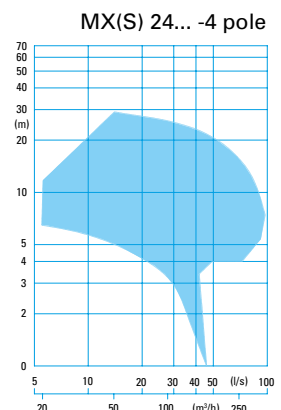

## DN 100

Enclosed single channel impeller  
100 mm Ø  
Spherical clearance  
960 rpm



PAGE 29

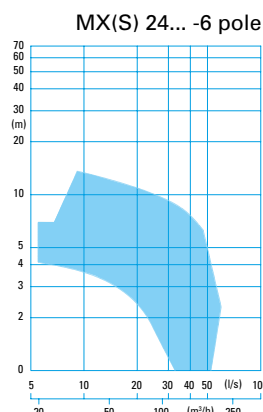

## DN 100

Vortex impeller  
100 mm Ø  
Spherical clearance  
1450 rpm



PAGE 30

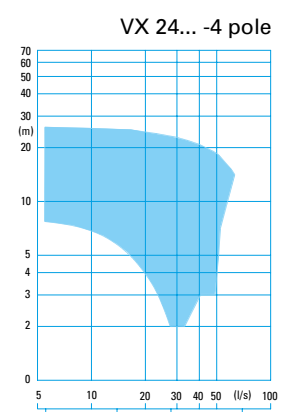

# DN 150 - PUMP RANGES SELECTION CHART

## DN 150

Enclosed single channel impeller  
100 mm Ø  
Spherical clearance  
1450 rpm



PAGE 31

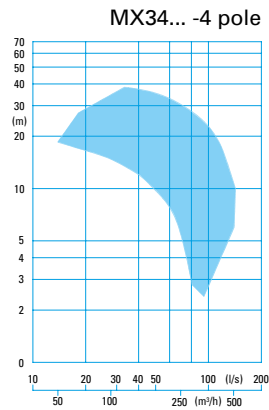

## DN 150

Enclosed single channel impeller  
100 mm Ø  
Spherical clearance  
960 rpm



PAGE 32

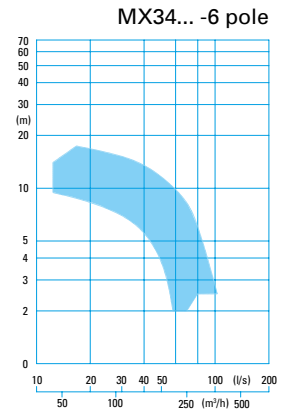

## DN 150

Enclosed two channel impeller  
80 mm Ø  
Spherical clearance  
1450 rpm



PAGE 33

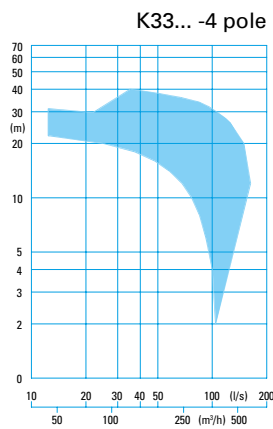

## DN 150

Enclosed two channel impeller  
80 mm Ø  
Spherical clearance  
960 rpm



PAGE 34

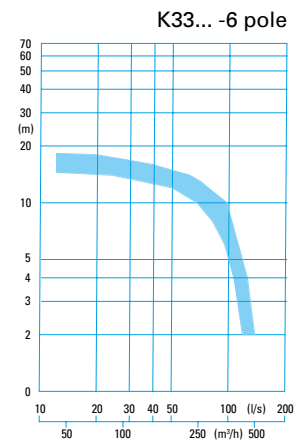

## DN 150

Vortex impeller  
100 mm Ø  
Spherical clearance  
1450 rpm



PAGE 35

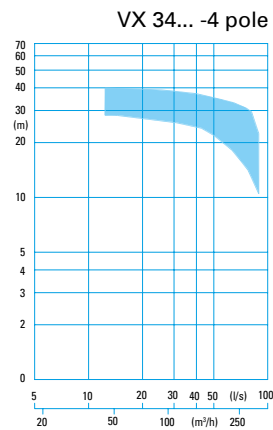

## DN 150

Vortex impeller  
100 mm Ø  
Spherical clearance  
960 rpm



PAGE 36

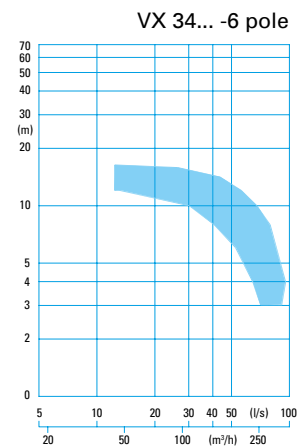

Unlimited applications: Stainless steel submersible pumps for chemically aggressive liquids (please see separate brochure)







# DN 80 - MXS 13...-2 POLE



## Enclosed single channel impeller

80 mm Ø Spherical clearance  
2900 rpm



### HYDRAULIC PERFORMANCE

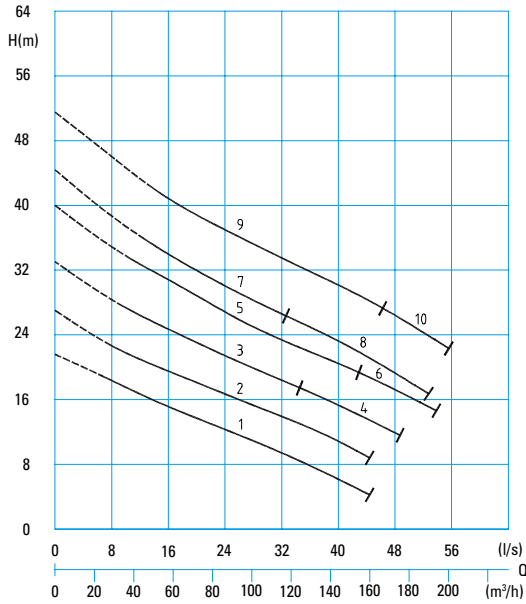

### Technical data

Curve No.	Pump type	WET WELL INSTALLATION				
		Motor P <sub>1</sub> (kW)	Motor P <sub>2</sub> (kW)	Rated current (A)	Weight normal (kg)	Weight Ex (kg)
①	MXS 1328-T72 (C)(Ex)	11,0	9,5	18,8	120	120
②	MXS 1330-T82 (C)(Ex)	13,0	11,5	22,2	123	123
③	MXS 1332-T82 (C)(Ex)	13,0	11,5	22,2	123	123
④	MXS 1332-P92 (C)(Ex)	16,0	14,4	27,0	178	190
⑤	MXS 1334-P92 (C)(Ex)	16,0	14,4	27,0	178	190
⑥	MXS 1334-P102 (C)(Ex)	22,0	19,6	36,9	178	190
⑦	MXS 1336-P92 (C)(Ex)	16,0	14,4	27,0	180	192
⑧	MXS 1336-P102 (C)(Ex)	22,0	19,6	36,9	180	192
⑨	MXS 1338-P102 (C)(Ex)	22,0	19,6	36,9	180	192
⑩	MXS 1338-P122 (C)(Ex)	28,0	25,4	46,3	198	210

### MOTOR OUTPUT

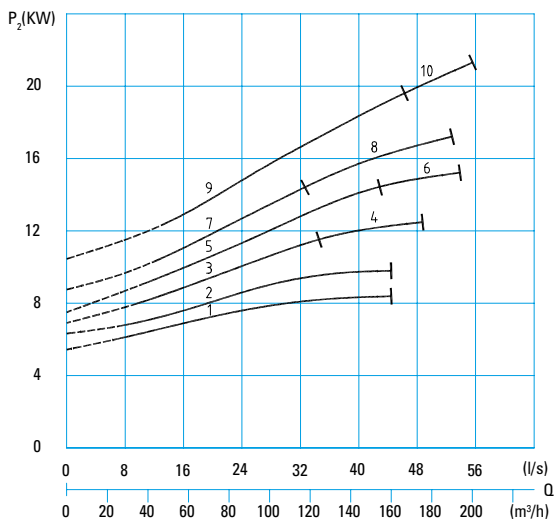

### Technical data

Curve No.	Pump type	DRY WELL INSTALLATION				
		Motor P <sub>1</sub> (kW)	Motor P <sub>2</sub> (kW)	Rated current (A)	Weight normal (kg)	Weight Ex (kg)
①	MXS 1328-ET72 (Ex)	10,5	9,5	20,1	146	146
②	MXS 1330-ET82 (Ex)	12,7	11,5	22,7	146	146
③	MXS 1332-ET82 (Ex)	12,7	11,5	22,7	146	146
④	MXS 1332-PU92 (Ex)	16,0	14,4	27,0	189	201
⑤	MXS 1334-PU92 (Ex)	16,0	14,4	27,0	189	201
⑥	MXS 1334-PU102 (Ex)	22,0	19,6	36,9	189	201
⑦	MXS 1336-PU92 (Ex)	16,0	14,4	27,0	191	203
⑧	MXS 1336-PU102 (Ex)	22,0	19,6	36,9	191	203
⑨	MXS 1338-PU102 (Ex)	22,0	19,6	36,9	191	203
⑩	MXS 1338-PU122 (Ex)	28,0	25,4	46,3	211	223

# DN 80 - MXS13...-4 POLE



## Enclosed single channel impeller

80 mm Ø Spherical clearance

1450 rpm



### HYDRAULIC PERFORMANCE

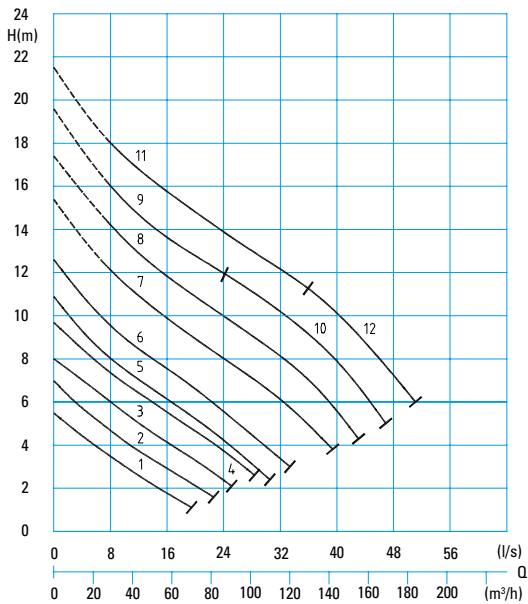

### Technical data

### WET WELL INSTALLATION

Curve No.	Pump type	Motor		Rated current (A)	Weight normal (kg)	Weight Ex (kg)
		P <sub>1</sub> (kW)	P <sub>2</sub> (kW)			
①	MXS 1328-C24 (C)(Ex)	1,7	1,3	3,3	74	74
②	MXS 1330-C24 (C)(Ex)	1,7	1,3	3,3	74	74
③	MXS 1332-D44 (C)(Ex)	3,4	2,6	6,2	80	80
④	MXS 1334-D44 (C)(Ex)	3,4	2,6	6,2	80	80
⑤	MXS 1336-D44 (C)(Ex)	3,4	2,6	6,2	82	82
⑥	MXS 1338-D44 (C)(Ex)	3,4	2,6	6,2	82	82
⑦	MXS 1340-T34 (C)(Ex)	3,4	2,9	5,8	117	117
⑧	MXS 1342-T44 (C)(Ex)	4,4	3,7	7,5	121	121
⑨	MXS 1344-T44 (C)(Ex)	4,4	3,7	7,5	121	121
⑩	MXS 1344-T54 (C)(Ex)	5,9	5,0	9,9	131	131
⑪	MXS 1346-T54 (C)(Ex)	5,9	5,0	9,9	131	131
⑫	MXS 1346-T64 (C)(Ex)	7,7	6,5	13,1	134	134

### MOTOR OUTPUT

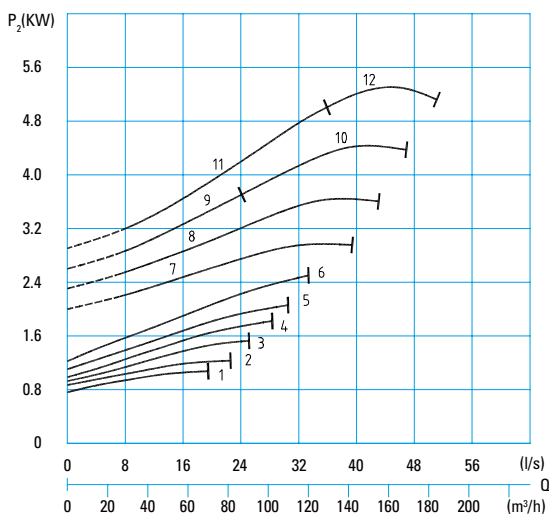

### Technical data

### DRY WELL INSTALLATION

Curve No.	Pump type	Motor		Rated current (A)	Weight normal (kg)	Weight Ex (kg)
		P <sub>1</sub> (kW)	P <sub>2</sub> (kW)			
①	MXS 1328-ET34 (Ex)	3,3	2,9	5,9	128	128
②	MXS 1330-ET34 (Ex)	3,3	2,9	5,9	128	128
③	MXS 1332-ET34 (Ex)	3,3	2,9	5,9	128	128
④	MXS 1334-ET34 (Ex)	3,3	2,9	5,9	128	128
⑤	MXS 1336-ET34 (Ex)	3,3	2,9	5,9	130	130
⑥	MXS 1338-ET34 (Ex)	3,3	2,9	5,9	130	130
⑦	MXS 1340-ET34 (Ex)	3,3	2,9	5,9	134	134
⑧	MXS 1342-ET44 (Ex)	4,3	3,7	7,3	134	134
⑨	MXS 1344-ET44 (Ex)	4,3	3,7	7,3	134	134
⑩	MXS 1344-ET54 (Ex)	6,1	5,0	10,2	134	134
⑪	MXS 1346-ET54 (Ex)	6,1	5,0	10,2	134	134
⑫	MXS 1346-ET64 (Ex)	7,4	6,5	13,4	152	152

# DN 80 - MXS 13...-6 POLE



## Enclosed single channel impeller

80 mm Ø Spherical clearance  
960 rpm



### HYDRAULIC PERFORMANCE

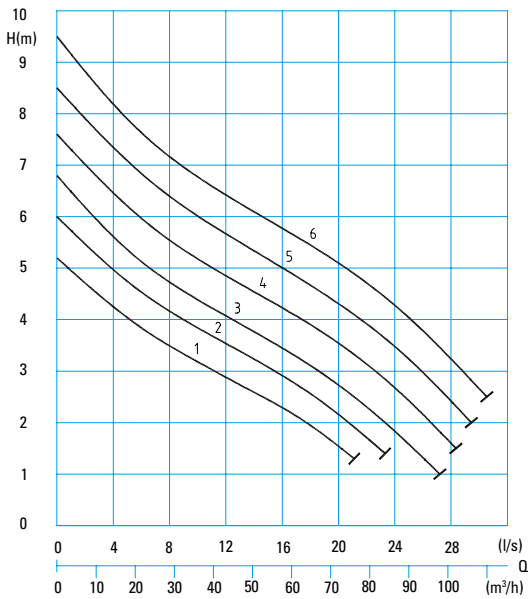

### Technical data

### WET WELL INSTALLATION

Curve No.	Pump type	Motor		Rated current (A)	Weight normal (kg)	Weight Ex (kg)
		P <sub>1</sub> (kW)	P <sub>2</sub> (kW)			
①	MXS 1336-T26 (C)(Ex)	2,1	1,6	4,0	116	116
②	MXS 1338-T26 (C)(Ex)	2,1	1,6	4,0	116	116
③	MXS 1340-T26 (C)(Ex)	2,1	1,6	4,0	120	120
④	MXS 1342-T26 (C)(Ex)	2,1	1,6	4,0	120	120
⑤	MXS 1344-T26 (C)(Ex)	2,1	1,6	4,0	120	120
⑥	MXS 1346-T26 (C)(Ex)	2,1	1,6	4,0	120	120

### MOTOR OUTPUT

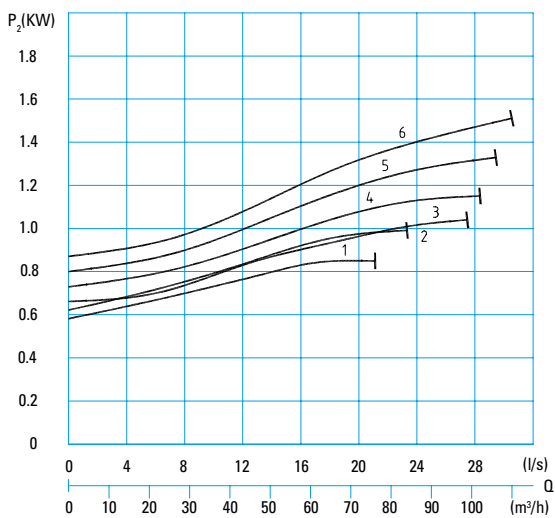

### Technical data

### DRY WELL INSTALLATION

Curve No.	Pump type	Motor		Rated current (A)	Weight normal (kg)	Weight Ex (kg)
		P <sub>1</sub> (kW)	P <sub>2</sub> (kW)			
①	MXS 1336-ET26 (Ex)	1,8	1,6	3,8	148	148
②	MXS 1338-ET26 (Ex)	1,8	1,6	3,8	148	148
③	MXS 1340-ET26 (Ex)	1,8	1,6	3,8	152	152
④	MXS 1342-ET26 (Ex)	1,8	1,6	3,8	152	152
⑤	MXS 1344-ET26 (Ex)	1,8	1,6	3,8	152	152
⑥	MXS 1346-ET26 (Ex)	1,8	1,6	3,8	152	152

# DN 80 - V13...-2 POLE



## Vortex impeller

80 mm Ø Spherical clearance  
2900 rpm



### HYDRAULIC PERFORMANCE

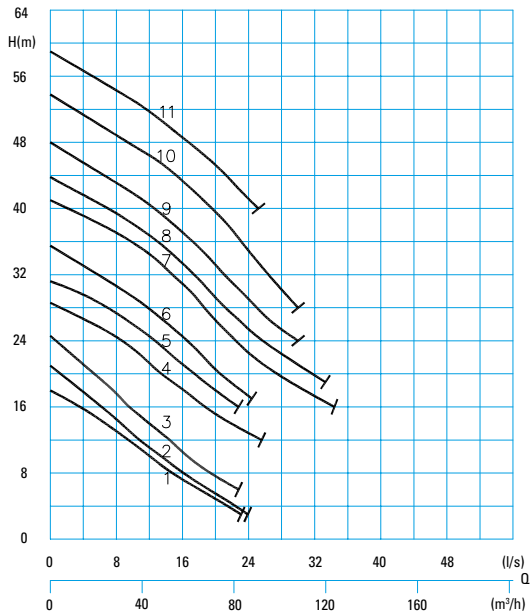

### Technical data

### WET WELL INSTALLATION

Curve No.	Pump type	Motor		Rated current (A)	Weight normal (kg)	Weight Ex (kg)
		P <sub>1</sub> (kW)	P <sub>2</sub> (kW)			
①	V 1332-T62 (C)(Ex)	7,5	6,4	13,0	91	91
②	V 1333-T62 (C)(Ex)	7,5	6,4	13,0	91	91
③	V 1334-T62 (C)(Ex)	7,5	6,4	13,0	91	91
④	V 1335-T72 (C)(Ex)	11,0	9,5	18,8	103	103
⑤	V 1337-T72 (C)(Ex)	11,0	9,5	18,8	103	103
⑥	V 1339-T82 (C)(Ex)	13,0	11,5	22,2	108	108
⑦	V 1342-P102 (C)(Ex)	22,0	19,6	36,9	176	188
⑧	V 1343-P102 (C)(Ex)	22,0	19,6	36,9	176	188
⑨	V 1344-P102 (C)(Ex)	22,0	19,6	36,9	176	188
⑩	V 1345-P122 (C)(Ex)	28,0	25,4	46,3	196	208
⑪	V 1346-P122 (C)(Ex)	28,0	25,4	46,3	196	208

### MOTOR OUTPUT

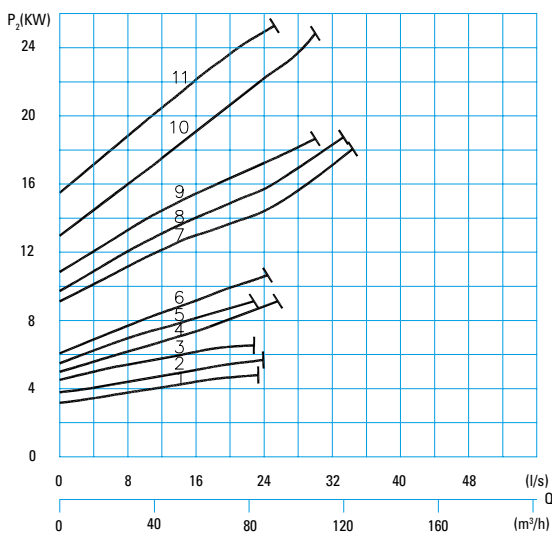

### Technical data

### DRY WELL INSTALLATION

Curve No.	Pump type	Motor		Rated current (A)	Weight normal (kg)	Weight Ex (kg)
		P <sub>1</sub> (kW)	P <sub>2</sub> (kW)			
①	V 1332-ET62 (Ex)	7,3	6,4	12,4	119	119
②	V 1333-ET62 (Ex)	7,3	6,4	12,4	119	119
③	V 1334-ET62 (Ex)	7,3	6,4	12,4	119	119
④	V 1335-ET72 (Ex)	10,5	9,5	20,1	139	139
⑤	V 1337-ET72 (Ex)	10,5	9,5	20,1	139	139
⑥	V 1339-ET82 (Ex)	12,7	11,5	22,7	139	139
⑦	V 1342-PU102 (Ex)	22,0	19,6	36,9	188	200
⑧	V 1343-PU102 (Ex)	22,0	19,6	36,9	188	200
⑨	V 1344-PU102 (Ex)	22,0	19,6	36,9	188	200
⑩	V 1345-PU122 (Ex)	28,0	25,4	46,3	208	220
⑪	V 1346-PU122 (Ex)	28,0	25,4	46,3	208	220

# DN 80 - V(X)13...-4 POLE



## Vortex impeller

80 mm Ø Spherical clearance  
1450 rpm



### HYDRAULIC PERFORMANCE

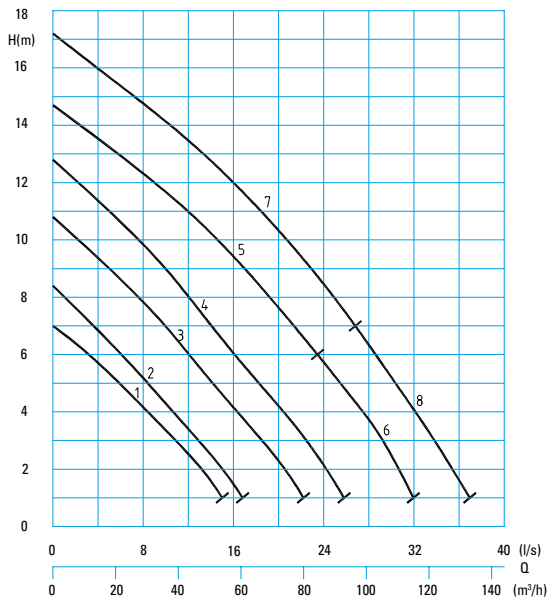

### Technical data

### WET WELL INSTALLATION

Curve No.	Pump type	Motor		Rated current (A)	Weight normal (kg)	Weight Ex (kg)
		P <sub>1</sub> (kW)	P <sub>2</sub> (kW)			
①	V 1334-C24 (C)(Ex)	1,7	1,3	3,3	63	64
②	V 1336-C24 (C)(Ex)	1,7	1,3	3,3	63	64
③	V 1344-D44 (C)(Ex)	3,4	2,6	6,2	66	67
④	V 1346-D44 (C)(Ex)	3,4	2,6	6,2	66	67
⑤	VX 1345-T44 (C)(Ex)	4,4	3,7	7,5	105	105
⑥	VX 1345-T54 (C)(Ex)	5,9	5,0	9,9	118	118
⑦	VX 1346-T54 (C)(Ex)	5,9	5,0	9,9	118	118
⑧	VX 1346-T64 (C)(Ex)	7,7	6,5	13,1	121	121

### MOTOR OUTPUT

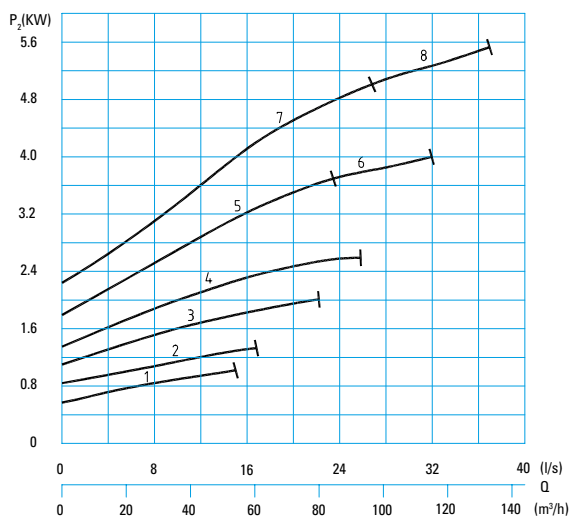

### Technical data

### DRY WELL INSTALLATION

Curve No.	Pump type	Motor		Rated current (A)	Weight normal (kg)	Weight Ex (kg)
		P <sub>1</sub> (kW)	P <sub>2</sub> (kW)			
①	V 1334-ET34 (Ex)	3,3	2,9	5,9	121	121
②	V 1336-ET34 (Ex)	3,3	2,9	5,9	121	121
③	V 1344-ET34 (Ex)	3,3	2,9	5,9	122	122
④	V 1346-ET34 (Ex)	3,3	2,9	5,9	122	122
⑤	VX 1345-ET44 (Ex)	4,3	3,7	7,3	122	122
⑥	VX 1345-ET54 (Ex)	6,1	5,0	10,2	122	122
⑦	VX 1346-ET54 (Ex)	6,1	5,0	10,2	122	122
⑧	VX 1346-ET64 (Ex)	7,4	6,5	13,4	139	139

# DN 100 - MXS 23...-2 POLE



## Enclosed single channel impeller

80 mm Ø Spherical clearance  
2900 rpm



### HYDRAULIC PERFORMANCE

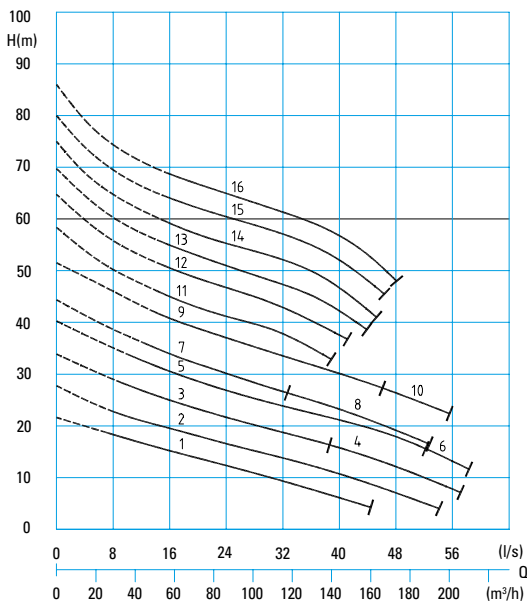

### Technical data

### WET WELL INSTALLATION

Curve No.	Pump type	Motor		Rated current (A)	Weight normal (kg)	Weight Ex (kg)
		P <sub>1</sub> (kW)	P <sub>2</sub> (kW)			
①	MXS 2328-T72 (C)(Ex)	11,0	9,5	18,8	120	120
②	MXS 2330-T82 (C)(Ex)	13,0	11,5	22,2	123	123
③	MXS 2332-T82 (C)(Ex)	13,0	11,5	22,2	123	123
④	MXS 2332-P92 (C)(Ex)	16,0	14,4	27,0	178	190
⑤	MXS 2334-P92 (C)(Ex)	16,0	14,4	27,0	178	190
⑥	MXS 2334-P102 (C)(Ex)	22,0	19,6	36,9	178	190
⑦	MXS 2336-P92 (C)(Ex)	16,0	14,4	27,0	180	192
⑧	MXS 2336-P102 (C)(Ex)	22,0	19,6	36,9	180	192
⑨	MXS 2338-P102 (C)(Ex)	22,0	19,6	36,9	180	192
⑩	MXS 2338-P122 (C)(Ex)	28,0	25,4	46,3	198	210
⑪	MXS 2340-F152 (C)	38,0	35,0	59,4	383	383
⑫	MXS 2341-F152 (C)	38,0	35,0	59,4	383	383
⑬	MXS 2342-F152 (C)	38,0	35,0	59,4	383	383
⑭	MXS 2344-F152 (C)	38,0	35,0	59,4	383	383
⑮	MXS 2345-F162 (C)	43,0	40,0	67,5	390	390
⑯	MXS 2346-F162 (C)	43,0	40,0	67,5	390	390

### MOTOR OUTPUT

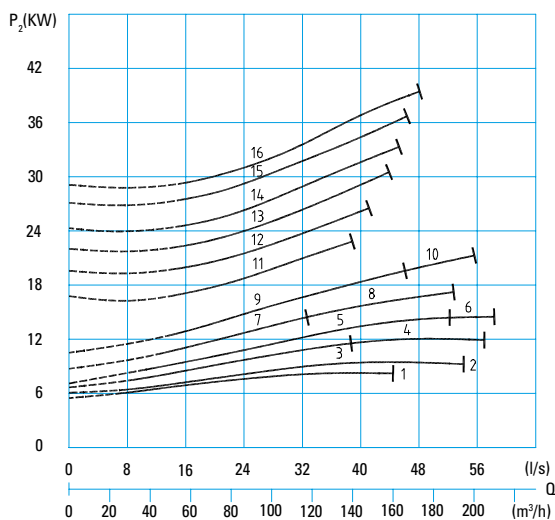

### Technical data

### DRY WELL INSTALLATION

Curve No.	Pump type	Motor		Rated current (A)	Weight normal (kg)	Weight Ex (kg)
		P <sub>1</sub> (kW)	P <sub>2</sub> (kW)			
①	MXS 2328-ET72 (Ex)	10,5	9,5	20,1	146	146
②	MXS 2330-ET82 (Ex)	12,7	11,5	22,7	146	146
③	MXS 2332-ET82 (Ex)	12,7	11,5	22,7	146	146
④	MXS 2332-PU92 (Ex)	16,0	14,4	27,0	189	201
⑤	MXS 2334-PU92 (Ex)	16,0	14,4	27,0	189	201
⑥	MXS 2334-PU102 (Ex)	22,0	19,6	36,9	189	201
⑦	MXS 2336-PU92 (Ex)	16,0	14,4	27,0	191	203
⑧	MXS 2336-PU102 (Ex)	22,0	19,6	36,9	191	203
⑨	MXS 2338-PU102 (Ex)	22,0	19,6	36,9	191	203
⑩	MXS 2338-PU122 (Ex)	28,0	25,4	46,3	211	223
⑪	MXS 2340-FU152	38,0	35,0	59,4	409	409
⑫	MXS 2341-FU152	38,0	35,0	59,4	409	409
⑬	MXS 2342-FU152	38,0	35,0	59,4	409	409
⑭	MXS 2344-FU152	38,0	35,0	59,4	409	409
⑮	MXS 2345-FU162	43,0	40,0	67,5	416	416
⑯	MXS 2346-FU162	43,0	40,0	67,5	416	416

# DN 100 - MXS 23...-4 POLE



## Enclosed single channel impeller

80 mm Ø Spherical clearance  
1450 rpm



### HYDRAULIC PERFORMANCE

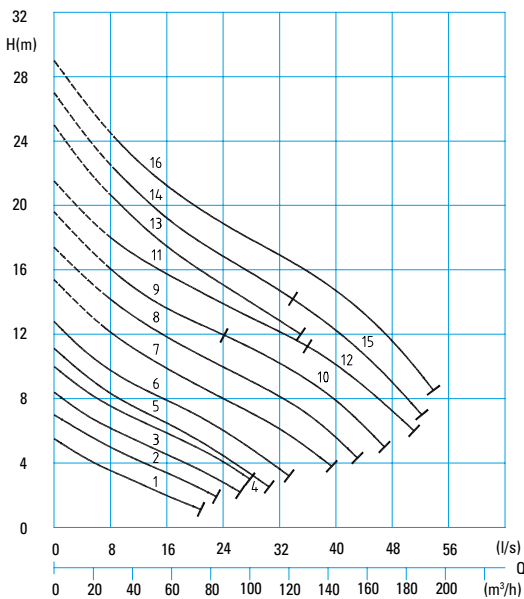

### Technical data

### WET WELL INSTALLATION

Curve No.	Pump type	Motor		Rated current (A)	Weight normal (kg)	Weight Ex (kg)
		P <sub>1</sub> (kW)	P <sub>2</sub> (kW)			
①	MXS 2328-C24 (C)(Ex)	1,7	1,3	3,3	74	74
②	MXS 2330-C24 (C)(Ex)	1,7	1,3	3,3	74	74
③	MXS 2332-D44 (C)(Ex)	3,4	2,6	6,2	80	80
④	MXS 2334-D44 (C)(Ex)	3,4	2,6	6,2	80	80
⑤	MXS 2336-D44 (C)(Ex)	3,4	2,6	6,2	82	82
⑥	MXS 2338-D44 (C)(Ex)	3,4	2,6	6,2	82	82
⑦	MXS 2340-T34 (C)(Ex)	3,4	2,9	5,8	118	118
⑧	MXS 2342-T44 (C)(Ex)	4,4	3,7	7,5	122	122
⑨	MXS 2344-T44 (C)(Ex)	4,4	3,7	7,5	122	122
⑩	MXS 2344-T54 (C)(Ex)	5,9	5,0	9,9	132	132
⑪	MXS 2346-T54 (C)(Ex)	5,9	5,0	9,9	132	132
⑫	MXS 2346-T64 (C)(Ex)	7,7	6,5	13,1	135	135
⑬	MXS 2350-T64 (C)(Ex)	7,7	6,5	13,1	142	142
⑭	MXS 2351-T64 (C)(Ex)	7,7	6,5	13,1	142	142
⑮	MXS 2351-ET74 (Ex)	9,8	8,5	16,8	168	168
⑯	MXS 2352-ET74 (Ex)	9,8	8,5	16,8	168	168

### MOTOR OUTPUT

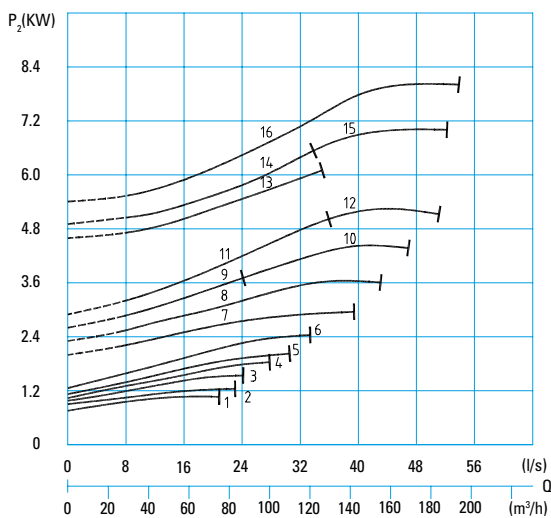

### Technical data

### DRY WELL INSTALLATION

Curve No.	Pump type	Motor		Rated current (A)	Weight normal (kg)	Weight Ex (kg)
		P <sub>1</sub> (kW)	P <sub>2</sub> (kW)			
①	MXS 2328-ET34 (Ex)	3,3	2,9	5,9	128	128
②	MXS 2330-ET34 (Ex)	3,3	2,9	5,9	128	128
③	MXS 2332-ET34 (Ex)	3,3	2,9	5,9	128	128
④	MXS 2334-ET34 (Ex)	3,3	2,9	5,9	128	128
⑤	MXS 2336-ET34 (Ex)	3,3	2,9	5,9	130	130
⑥	MXS 2338-ET34 (Ex)	3,3	2,9	5,9	130	130
⑦	MXS 2340-ET34 (Ex)	3,3	2,9	5,9	135	135
⑧	MXS 2342-ET44 (Ex)	4,3	3,7	7,3	135	135
⑨	MXS 2344-ET44 (Ex)	4,3	3,7	7,3	135	135
⑩	MXS 2344-ET54 (Ex)	6,1	5,0	10,2	135	135
⑪	MXS 2346-ET54 (Ex)	6,1	5,0	10,2	135	135
⑫	MXS 2346-ET64 (Ex)	7,4	6,5	13,4	153	153
⑬	MXS 2350-ET64 (Ex)	7,4	6,5	13,4	168	168
⑭	MXS 2351-ET64 (Ex)	7,4	6,5	13,4	168	168
⑮	MXS 2351-ET74 (Ex)	9,8	8,5	16,8	168	168
⑯	MXS 2352-ET74 (Ex)	9,8	8,5	16,8	168	168



# DN 100 - V23...-2 POLE



## Vortex impeller

80 mm Ø Spherical clearance  
2900 rpm



### HYDRAULIC PERFORMANCE

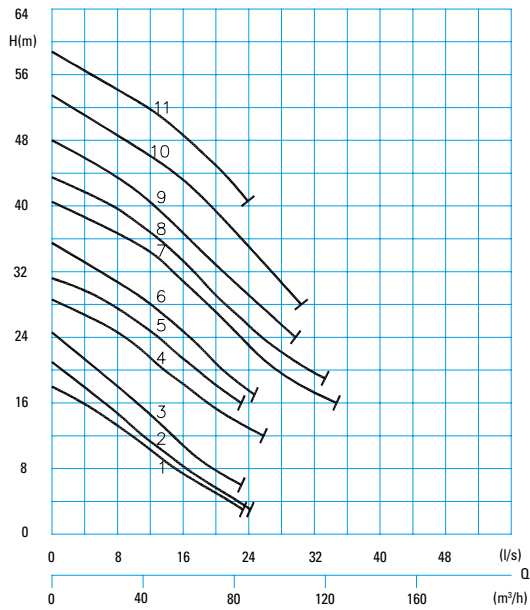

### Technical data

### WET WELL INSTALLATION

Curve No.	Pump type	Motor		Rated current (A)	Weight normal (kg)	Weight Ex (kg)
		P <sub>1</sub> (kW)	P <sub>2</sub> (kW)			
①	V 2332-T62 (C)(Ex)	7,5	6,4	13,0	93	93
②	V 2333-T62 (C)(Ex)	7,5	6,4	13,0	93	93
③	V 2334-T62 (C)(Ex)	7,5	6,4	13,0	93	93
④	V 2335-T72 (C)(Ex)	11,0	9,5	18,8	105	105
⑤	V 2337-T72 (C)(Ex)	11,0	9,5	18,8	105	105
⑥	V 2339-T82 (C)(Ex)	13,0	11,5	22,2	110	110
⑦	V 2342-P102 (C)(Ex)	22,0	19,6	36,9	178	190
⑧	V 2343-P102 (C)(Ex)	22,0	19,6	36,9	178	190
⑨	V 2344-P102 (C)(Ex)	22,0	19,6	36,9	178	190
⑩	V 2345-P122 (C)(Ex)	28,0	25,4	46,3	198	210
⑪	V 2346-P122 (C)(Ex)	28,0	25,4	46,3	198	210

### MOTOR OUTPUT

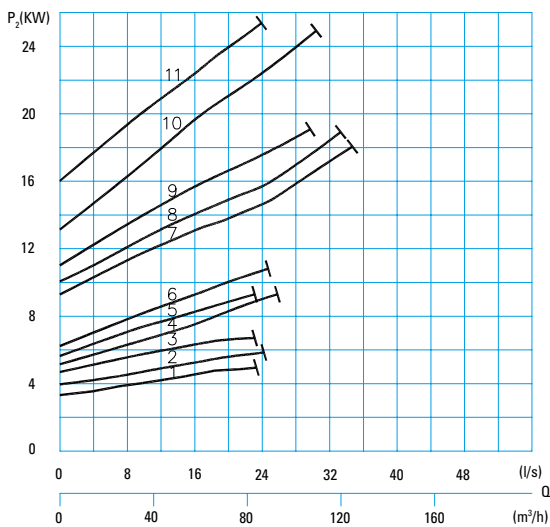

### Technical data

### DRY WELL INSTALLATION

Curve No.	Pump type	Motor		Rated current (A)	Weight normal (kg)	Weight Ex (kg)
		P <sub>1</sub> (kW)	P <sub>2</sub> (kW)			
①	V 2332-ET62 (Ex)	7,3	6,4	12,4	121	121
②	V 2333-ET62 (Ex)	7,3	6,4	12,4	121	121
③	V 2334-ET62 (Ex)	7,3	6,4	12,4	121	121
④	V 2335-ET72 (Ex)	10,5	9,5	20,1	141	141
⑤	V 2337-ET72 (Ex)	10,5	9,5	20,1	141	141
⑥	V 2339-ET82 (Ex)	12,7	11,5	22,7	141	141
⑦	V 2342-PU102 (Ex)	22,0	19,6	36,9	190	202
⑧	V 2343-PU102 (Ex)	22,0	19,6	36,9	190	202
⑨	V 2344-PU102 (Ex)	22,0	19,6	36,9	190	202
⑩	V 2345-PU122 (Ex)	28,0	25,4	46,3	210	222
⑪	V 2346-PU122 (Ex)	28,0	25,4	46,3	210	222

# DN 100 - V(X) 23...-4 POLE



## Vortex impeller

80 mm Ø Spherical clearance  
1450 rpm



### HYDRAULIC PERFORMANCE

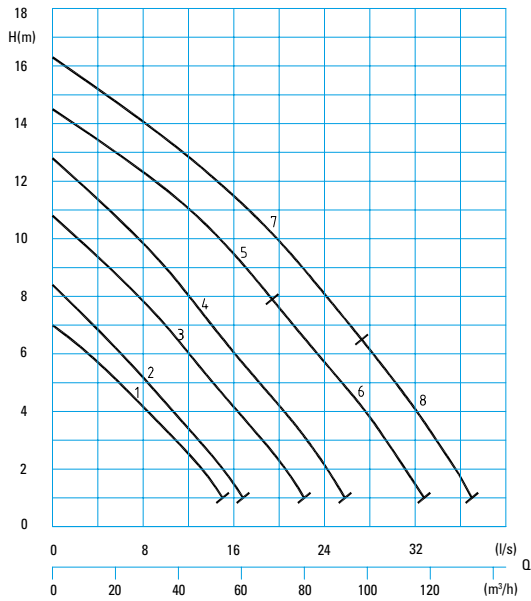

### Technical data

### WET WELL INSTALLATION

Curve No.	Pump type	Motor		Rated current (A)	Weight normal (kg)	Weight Ex (kg)
		P <sub>1</sub> (kW)	P <sub>2</sub> (kW)			
①	V 2334-C24 (C)(Ex)	1,7	1,3	3,3	65	65
②	V 2336-C24 (C)(Ex)	1,7	1,3	3,3	65	65
③	V 2344-D44 (C)(Ex)	3,4	2,6	6,2	68	68
④	V 2346-D44 (C)(Ex)	3,4	2,6	6,2	68	68
⑤	VX 2345-T44 (C)(Ex)	4,4	3,7	7,5	107	107
⑥	VX 2345-T54 (C)(Ex)	5,9	5,0	9,9	120	120
⑦	VX 2346-T54 (C)(Ex)	5,9	5,0	9,9	120	120
⑧	VX 2346-T64 (C)(Ex)	7,7	6,5	13,1	123	123

### MOTOR OUTPUT

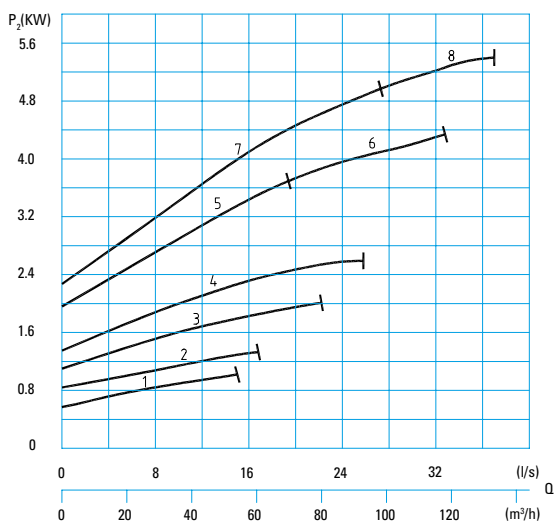

### Technical data

### DRY WELL INSTALLATION

Curve No.	Pump type	Motor		Rated current (A)	Weight normal (kg)	Weight Ex (kg)
		P <sub>1</sub> (kW)	P <sub>2</sub> (kW)			
①	V 2334-ET34 (Ex)	3,3	2,9	5,9	123	123
②	V 2336-ET34 (Ex)	3,3	2,9	5,9	123	123
③	V 2344-ET34 (Ex)	3,3	2,9	5,9	124	124
④	V 2346-ET34 (Ex)	3,3	2,9	5,9	124	124
⑤	VX 2345-ET44 (Ex)	4,3	3,7	7,3	124	124
⑥	VX 2345-ET54 (Ex)	6,1	5,0	10,2	124	124
⑦	VX 2346-ET54 (Ex)	6,1	5,0	10,2	124	124
⑧	VX 2346-ET64 (Ex)	7,4	6,5	13,4	141	141

# DN 100 - KX 23...-4 POLIG



## Enclosed two channel impeller

80 mm Ø Spherical clearance  
1450 rpm



### HYDRAULIC PERFORMANCE

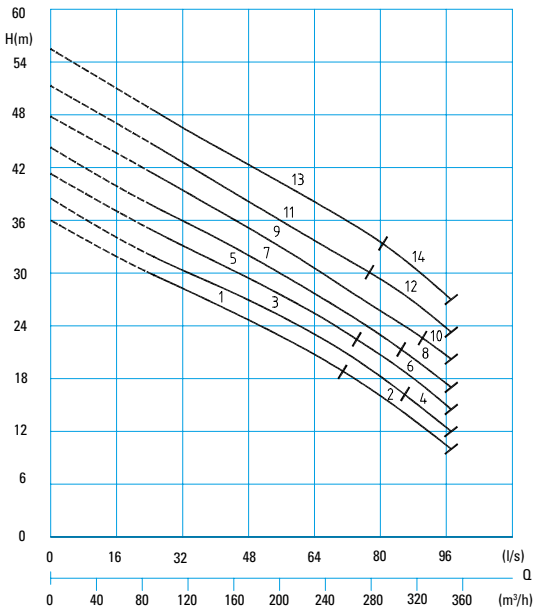

### Technical data

### WET WELL INSTALLATION

Curve No.	Pump type	Motor P <sub>1</sub> (kW)	Motor P <sub>2</sub> (kW)	Rated current (A)	Weight normal (kg)	Weight Ex (kg)
①	KX 2360-F114 (C)(Ex)	25,0	22,0	44,0	429	429
②	KX 2360-F124 (C)(Ex)	29,1	25,6	51,4	451	451
③	KX 2362-F124 (C)(Ex)	29,1	25,6	51,4	452	452
④	KX 2362-F134 (C)(Ex)	32,8	29,2	59,0	467	467
⑤	KX 2364-F124 (C)(Ex)	29,1	25,6	51,4	453	453
⑥	KX 2364-F134 (C)(Ex)	32,8	29,2	59,0	468	468
⑦	KX 2366-F134 (C)(Ex)	32,8	29,2	59,0	469	469
⑧	KX 2366-F144 (C)(Ex)	37,1	33,0	67,1	484	484
⑨	KX 2368-F144 (C)(Ex)	37,1	33,0	67,1	485	485
⑩	KX 2368-G154 (C)(Ex)	41,1	37,4	70,4	502	502
⑪	KX 2370-G144 (C)(Ex)	37,1	33,0	67,1	486	486
⑫	KX 2370-G154 (C)(Ex)	41,1	37,4	70,4	503	503
⑬	KX 2372-G154 (C)(Ex)	41,1	37,4	70,4	504	504
⑭	KX 2372-G174 (C)(Ex)	50,1	46,1	84,3	532	532

### MOTOR OUTPUT

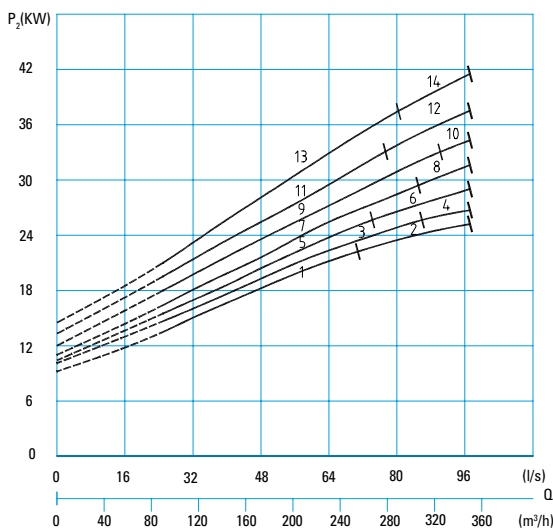

### Technical data

### DRY WELL INSTALLATION

Curve No.	Pump type	Motor P <sub>1</sub> (kW)	Motor P <sub>2</sub> (kW)	Rated current (A)	Weight normal (kg)	Weight Ex (kg)
①	KX 2360-FU114 (Ex)	25,0	22,0	44,0	450	450
②	KX 2360-FU124 (Ex)	29,1	25,6	51,4	477	477
③	KX 2362-FU124 (Ex)	29,1	25,6	51,4	478	478
④	KX 2362-FU134 (Ex)	32,8	29,2	59,0	493	493
⑤	KX 2364-FU124 (Ex)	29,1	25,6	51,4	479	479
⑥	KX 2364-FU134 (Ex)	32,8	29,2	59,0	494	494
⑦	KX 2366-FU134 (Ex)	32,8	29,2	59,0	495	495
⑧	KX 2366-FU144 (Ex)	37,1	33,0	67,1	510	510
⑨	KX 2368-FU144 (Ex)	37,1	33,0	67,1	511	511
⑩	KX 2368-GU154 (Ex)	41,1	37,4	70,4	528	528
⑪	KX 2370-GU144 (Ex)	37,1	33,0	67,1	512	512
⑫	KX 2370-GU154 (Ex)	41,1	37,4	70,4	529	529
⑬	KX 2372-GU154 (Ex)	41,1	37,4	70,4	530	530
⑭	KX 2372-GU174 (Ex)	50,1	46,1	84,3	561	561

# DN 100 - MX(S) 24...-4 POLE



## Enclosed single channel impeller

100 mm Ø Spherical clearance  
1450 rpm



### HYDRAULIC PERFORMANCE

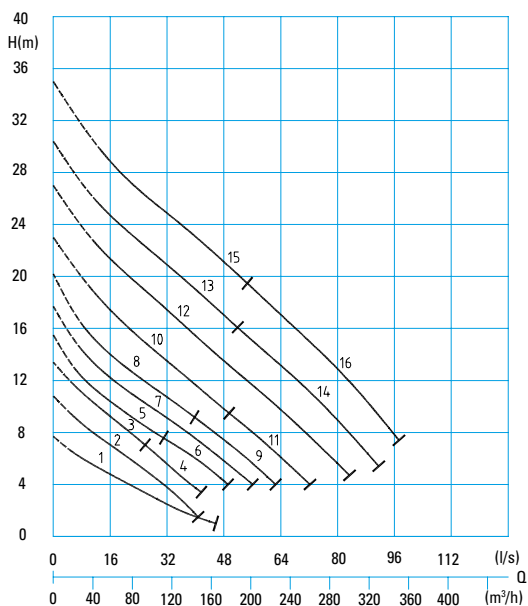

### Technical data

Curve No.	Pump type	WET WELL INSTALLATION				
		Motor P <sub>1</sub> (kW)	Motor P <sub>2</sub> (kW)	Rated current (A)	Weight normal (kg)	Weight Ex (kg)
①	M 2432-T34 (C)(Ex)	3,4	2,9	5,8	102	102
②	MX 2436-T34 (C)(Ex)	3,4	2,9	5,8	104	104
③	MX 2438-T34 (C)(Ex)	3,4	2,9	5,8	104	104
④	MX 2438-T44 (C)(Ex)	4,4	3,7	7,5	108	108
⑤	MXS 2442-T44 (C)(Ex)	4,4	3,7	7,5	129	129
⑥	MXS 2442-T54 (C)(Ex)	5,9	5,0	9,9	139	139
⑦	MXS 2444-T54 (C)(Ex)	5,9	5,0	9,9	139	139
⑧	MXS 2446-T54 (C)(Ex)	5,9	5,0	9,9	139	139
⑨	MXS 2446-T64 (C)(Ex)	7,7	6,5	13,1	142	142
⑩	MXS 2450-ET74 (Ex)	9,8	8,5	16,8	184	184
⑪	MXS 2450-P84 (C)(Ex)	14,0	12,2	23,0	209	221
⑫	MXS 2454-P84 (C)(Ex)	14,0	12,2	23,0	209	221
⑬	MXS 2457-P84 (C)(Ex)	14,0	12,2	23,0	209	221
⑭	MXS 2457-P94 (C)(Ex)	17,0	14,6	28,8	209	221
⑮	MXS 2460-P94 (C)(Ex)	17,0	14,6	28,8	209	221
⑯	MXS 2460-P104 (C)(Ex)	22,0	19,3	36,5	231	243

### MOTOR OUTPUT

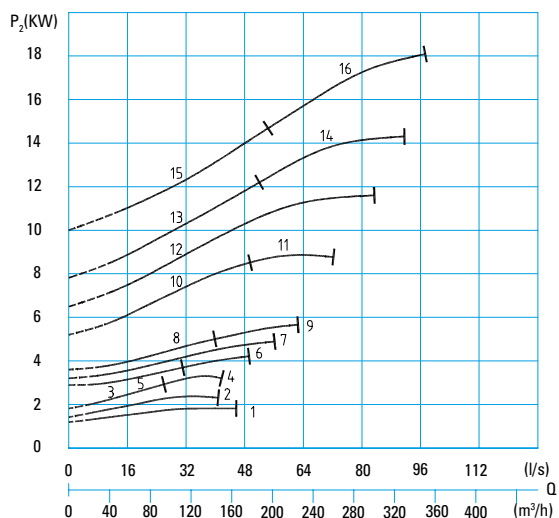

### Technical data

Curve No.	Pump type	DRY WELL INSTALLATION				
		Motor P <sub>1</sub> (kW)	Motor P <sub>2</sub> (kW)	Rated current (A)	Weight normal (kg)	Weight Ex (kg)
①	M 2432-ET34 (Ex)	3,3	2,9	5,9	138	138
②	MX 2436-ET34 (Ex)	3,3	2,9	5,9	138	138
③	MX 2438-ET34 (Ex)	3,3	2,9	5,9	138	138
④	MX 2438-ET44 (Ex)	4,3	3,7	7,3	138	138
⑤	MXS 2442-ET44 (Ex)	4,3	3,7	7,3	142	142
⑥	MXS 2442-ET54 (Ex)	6,1	5,0	10,2	142	142
⑦	MXS 2444-ET54 (Ex)	6,1	5,0	10,2	142	142
⑧	MXS 2446-ET54 (Ex)	6,1	5,0	10,2	142	142
⑨	MXS 2446-ET64 (Ex)	7,4	6,5	13,4	160	160
⑩	MXS 2450-ET74 (Ex)	9,8	8,5	16,8	184	184
⑪	MXS 2450-PU84 (Ex)	14,0	12,2	23,0	219	231
⑫	MXS 2454-PU84 (Ex)	14,0	12,2	23,0	219	231
⑬	MXS 2457-PU84 (Ex)	14,0	12,2	23,0	219	231
⑭	MXS 2457-PU94 (Ex)	17,0	14,6	28,8	219	231
⑮	MXS 2460-PU94 (Ex)	17,0	14,6	28,8	219	231
⑯	MXS 2460-PU104 (Ex)	22,0	19,3	36,5	244	256

# DN 100 - MX(S) 24...-6 POLE



## Enclosed single channel impeller

100 mm Ø Spherical clearance  
960 rpm



### HYDRAULIC PERFORMANCE

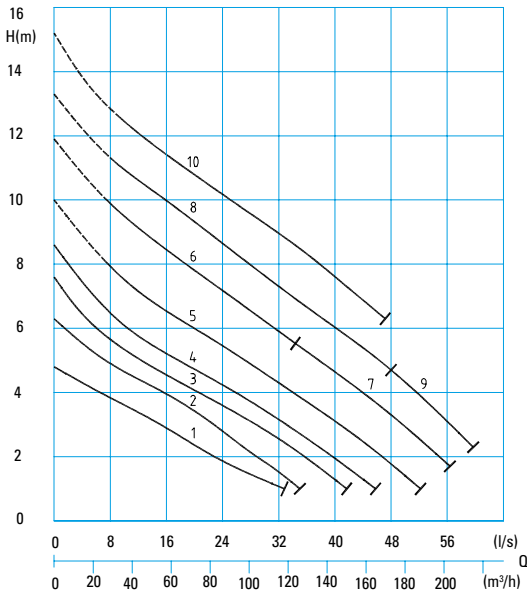

### Technical data

### WET WELL INSTALLATION

Curve No.	Pump type	Motor		Rated current (A)	Weight normal (kg)	Weight Ex (kg)
		P <sub>1</sub> (kW)	P <sub>2</sub> (kW)			
①	MX 2436-T36 (C)(Ex)	3,0	2,3	5,4	104	104
②	MX 2438-T36 (C)(Ex)	3,0	2,3	5,4	104	104
③	MXS 2444-T26 (C)(Ex)	2,1	1,6	4,0	125	125
④	MXS 2446-T36 (C)(Ex)	3,0	2,3	5,4	125	125
⑤	MXS 2450-T46 (C)(Ex)	4,0	3,1	7,3	145	145
⑥	MXS 2454-T46 (C)(Ex)	4,0	3,1	7,3	145	145
⑦	MXS 2454-T56 (C)(Ex)	5,0	4,0	9,6	155	155
⑧	MXS 2457-T56 (C)(Ex)	5,0	4,0	9,6	155	155
⑨	MXS 2457-T66 (C)(Ex)	6,0	4,9	11,5	158	158
⑩	MXS 2460-T66 (C)(Ex)	6,0	4,9	11,5	158	158

### MOTOR OUTPUT

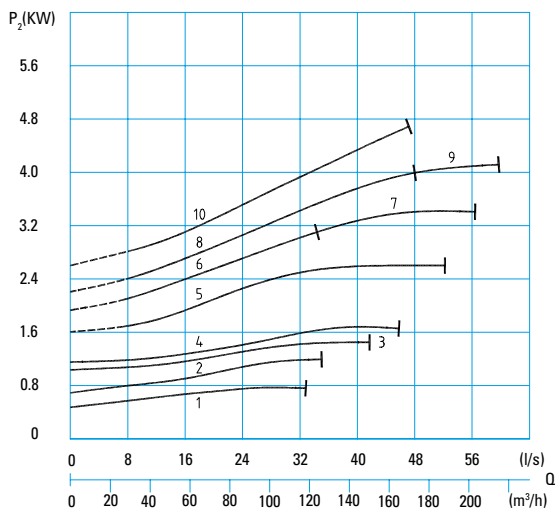

### Technical data

### DRY WELL INSTALLATION

Curve No.	Pump type	Motor		Rated current (A)	Weight normal (kg)	Weight Ex (kg)
		P <sub>1</sub> (kW)	P <sub>2</sub> (kW)			
①	MX 2436-ET36 (Ex)	2,7	2,3	4,9	156	156
②	MX 2438-ET36 (Ex)	2,7	2,3	4,9	156	156
③	MXS 2444-ET26 (Ex)	1,8	1,6	3,8	160	160
④	MXS 2446-ET36 (Ex)	2,7	2,3	4,9	160	160
⑤	MXS 2450-ET46 (Ex)	3,6	3,1	6,6	184	184
⑥	MXS 2454-ET46 (Ex)	3,6	3,1	6,6	184	184
⑦	MXS 2454-ET56 (Ex)	4,7	4,0	8,3	184	184
⑧	MXS 2457-ET56 (Ex)	4,7	4,0	8,3	184	184
⑨	MXS 2457-ET66 (Ex)	5,9	4,9	10,3	184	184
⑩	MXS 2460-ET66 (Ex)	5,9	4,9	10,3	184	184

# DN 100 - VX 24...-4 POLE



## Vortex impeller

100 mm Ø Spherical clearance  
1450 rpm



### HYDRAULIC PERFORMANCE

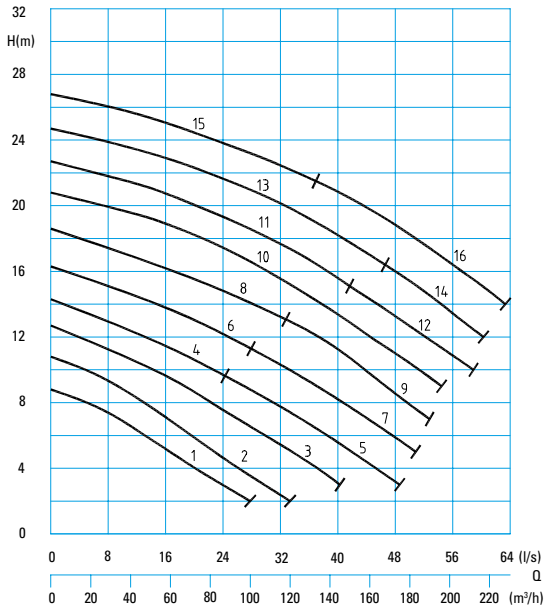

### Technical data

Curve No.	Pump type	WET WELL INSTALLATION				
		Motor P <sub>1</sub> (kW)	Motor P <sub>2</sub> (kW)	Rated current (A)	Weight normal (kg)	Weight Ex (kg)
①	VX 2436-D54 (C)(Ex)	4,0	3,2	7,3	78	78
②	VX 2439-D54 (C)(Ex)	4,0	3,2	7,3	78	78
③	VX 2440-T54 (C)(Ex)	5,9	5,0	9,9	123	123
④	VX 2442-T54 (C)(Ex)	5,9	5,0	9,9	123	123
⑤	VX 2442-T64 (C)(Ex)	7,7	6,5	13,1	126	126
⑥	VX 2444-T64 (C)(Ex)	7,7	6,5	13,1	126	126
⑦	VX 2444-ET74 (Ex)	9,8	8,5	16,8	144	144
⑧	VX 2446-ET74 (Ex)	9,8	8,5	16,8	144	144
⑨	VX 2446-P84 (C)(Ex)	14,0	12,2	23,0	177	189
⑩	VX 2452-P84 (C)(Ex)	14,0	12,2	23,0	205	217
⑪	VX 2454-P84 (C)(Ex)	14,0	12,2	23,0	205	217
⑫	VX 2454-P94 (C)(Ex)	17,0	14,6	28,8	205	217
⑬	VX 2456-P94 (C)(Ex)	17,0	14,6	28,8	205	217
⑭	VX 2456-P104 (C)(Ex)	22,0	19,3	36,5	227	239
⑮	VX 2458-P94 (C)(Ex)	17,0	14,6	28,8	205	217
⑯	VX 2458-P104 (C)(Ex)	22,0	19,3	36,5	227	239

### MOTOR OUTPUT

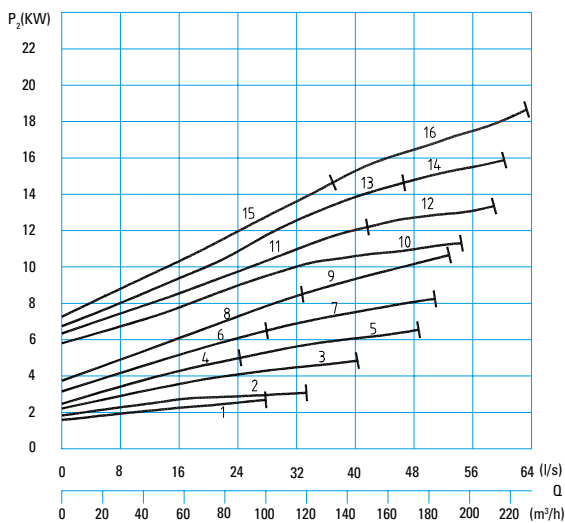

### Technical data

Curve No.	Pump type	DRY WELL INSTALLATION				
		Motor P <sub>1</sub> (kW)	Motor P <sub>2</sub> (kW)	Rated current (A)	Weight normal (kg)	Weight Ex (kg)
①	VX 2436-ET44 (Ex)	4,3	3,7	7,3	123	123
②	VX 2439-ET44 (Ex)	4,3	3,7	7,3	123	123
③	VX 2440-ET54 (Ex)	6,1	5,0	10,2	126	126
④	VX 2442-ET54 (Ex)	6,1	5,0	10,2	126	126
⑤	VX 2442-ET64 (Ex)	7,4	6,5	13,4	144	144
⑥	VX 2444-ET64 (Ex)	7,4	6,5	13,4	144	144
⑦	VX 2444-ET74 (Ex)	9,8	8,5	16,8	144	144
⑧	VX 2446-ET74 (Ex)	9,8	8,5	16,8	144	144
⑨	VX 2446-PU84 (Ex)	14,0	12,2	23,0	187	199
⑩	VX 2452-PU84 (Ex)	14,0	12,2	23,0	215	227
⑪	VX 2454-PU84 (Ex)	14,0	12,2	23,0	215	227
⑫	VX 2454-PU94 (Ex)	17,0	14,6	28,8	215	227
⑬	VX 2456-PU94 (Ex)	17,0	14,6	28,8	215	227
⑭	VX 2456-PU104 (Ex)	22,0	19,3	36,5	240	252
⑮	VX 2458-PU94 (Ex)	17,0	14,6	28,8	215	227
⑯	VX 2458-PU104 (Ex)	22,0	19,3	36,5	240	252

# DN 150 - MX(S) 34...-4 POLE



## Enclosed single channel impeller

100 mm Ø Spherical clearance  
1450 rpm



### HYDRAULIC PERFORMANCE

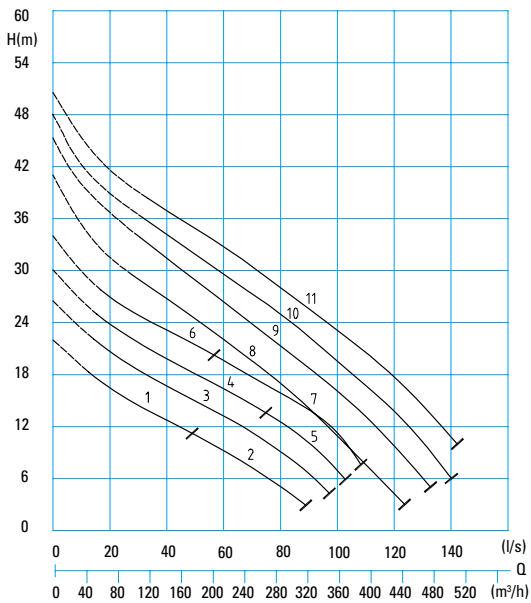

### Technical data

Curve No.	Pump type	WET WELL INSTALLATION				
		Motor P <sub>1</sub> (kW)	Motor P <sub>2</sub> (kW)	Rated current (A)	Weight normal (kg)	Weight Ex (kg)
②	MXS3450-P84 (C)(Ex)	14,0	12,2	23,0	227	239
③	MXS3454-P84 (C) (Ex)	14,0	12,2	23,0	227	239
④	MXS3457-P94 (C) (Ex)	17,0	14,6	28,8	227	239
⑤	MXS3457-P104 (C) (Ex)	22,0	19,3	36,5	249	261
⑥	MXS3460-P94 (C)(Ex)	17,0	14,6	28,8	227	239
⑦	MXS3460-P104 (C) (Ex)	22,0	19,3	36,5	249	261
⑧	MX 3468-F114 (C)(Ex)	25,0	22,0	44,0	388	388
⑨	MX 3470-F124 (C)(Ex)	29,1	25,6	51,4	410	410
⑩	MX 3472-F134 (C)(Ex)	32,8	29,2	59,0	420	420
⑪	MX 3474-F144 (C)(Ex)	37,1	33,0	67,1	430	430

### MOTOR OUTPUT

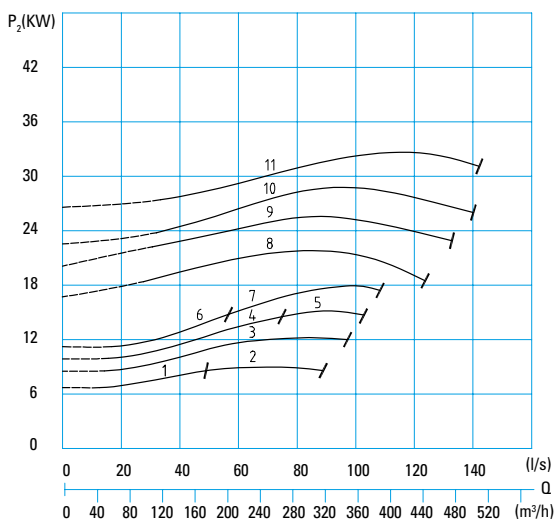

### Technical data

Curve No.	Pump type	DRY WELL INSTALLATION				
		Motor P <sub>1</sub> (kW)	Motor P <sub>2</sub> (kW)	Rated current (A)	Weight normal (kg)	Weight Ex (kg)
①	MXS3450-ET74 (Ex)	9,8	8,5	16,8	202	202
②	MXS3450-PU84 (Ex)	14,0	12,2	23,0	237	249
③	MXS3454-PU84 (Ex)	14,0	12,2	23,0	237	249
④	MXS3457-PU94 (Ex)	17,0	14,6	28,8	237	249
⑤	MXS3457-PU104 (Ex)	22,0	19,3	36,5	262	274
⑥	MXS3460-PU94 (Ex)	17,0	14,6	28,8	237	249
⑦	MXS3460-PU104 (Ex)	22,0	19,3	36,5	262	274
⑧	MX 3468-FU114 (Ex)	25,0	22,0	44,0	409	409
⑨	MX 3470-FU124 (Ex)	29,1	25,6	51,4	436	436
⑩	MX 3472-FU134 (Ex)	32,8	29,2	59,0	436	436
⑪	MX 3474-FU144 (Ex)	37,1	33,0	67,1	456	456

# DN 150 - MX(S) 34...-6 POLE



## Enclosed single channel impeller

100 mm Ø Spherical clearance  
960 rpm



### HYDRAULIC PERFORMANCE

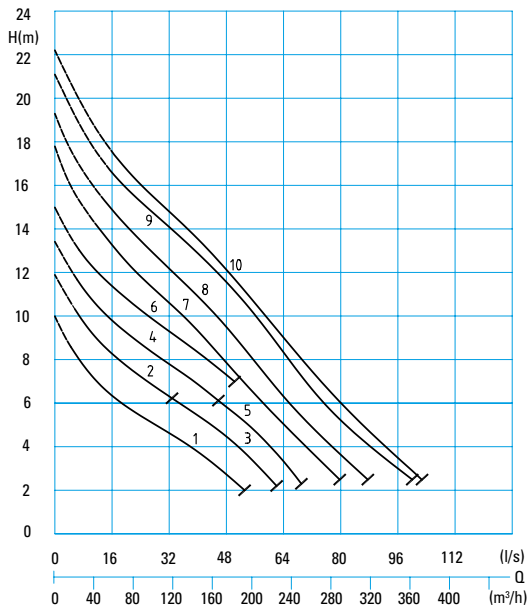

### Technical data

### WET WELL INSTALLATION

Curve No.	Pump type	Motor		Rated current (A)	Weight normal (kg)	Weight Ex (kg)
		P <sub>1</sub> (kW)	P <sub>2</sub> (kW)			
①	MXS3450-T46 (C)(Ex)	4,0	3,1	7,3	163	163
②	MXS3454-T46 (C)(Ex)	4,0	3,1	7,3	163	163
③	MXS3454-T56 (C)(Ex)	5,0	4,0	9,6	173	173
④	MXS3457-T56 (C)(Ex)	5,0	4,0	9,6	173	173
⑤	MXS3457-T66 (C)(Ex)	6,0	4,9	11,5	176	176
⑥	MXS3460-T66 (C)(Ex)	6,0	4,9	11,5	176	176
⑦	MX 3468-P76 (C)(Ex)	9,0	7,3	16,3	260	272
⑧	MX 3470-P76 (C)(Ex)	9,0	7,3	16,3	260	272
⑨	MX 3472-P86 (C)(Ex)	12,0	10,0	22,4	285	297
⑩	MX 3474-P86 (C)(Ex)	12,0	10,0	22,4	285	297

### MOTOR OUTPUT

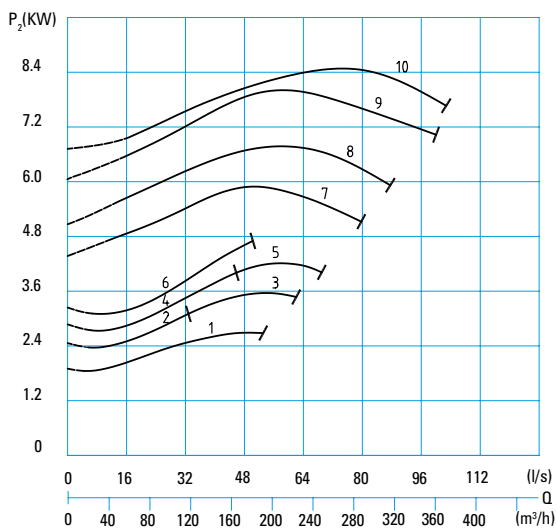

### Technical data

### DRY WELL INSTALLATION

Curve No.	Pump type	Motor		Rated current (A)	Weight normal (kg)	Weight Ex (kg)
		P <sub>1</sub> (kW)	P <sub>2</sub> (kW)			
①	MXS3450-ET46 (Ex)	3,6	3,1	6,6	202	202
②	MXS3454-ET46 (Ex)	3,6	3,1	6,6	202	202
③	MXS3454-ET56 (Ex)	4,7	4,0	8,3	202	202
④	MXS3457-ET56 (Ex)	4,7	4,0	8,3	202	202
⑤	MXS3457-ET66 (Ex)	5,9	4,9	10,3	202	202
⑥	MXS3460-ET66 (Ex)	5,9	4,9	10,3	202	202
⑦	MX 3468-PU76 (Ex)	9,0	7,3	16,3	267	279
⑧	MX 3470-PU76 (Ex)	9,0	7,3	16,3	267	279
⑨	MX 3472-PU86 (Ex)	12,0	10,0	22,4	292	304
⑩	MX 3474-PU86 (Ex)	12,0	10,0	22,4	292	304



# DN 150 - K33...-4 POLE



## Enclosed two channel impeller

80 mm Ø Spherical clearance  
1450 rpm



### HYDRAULIC PERFORMANCE

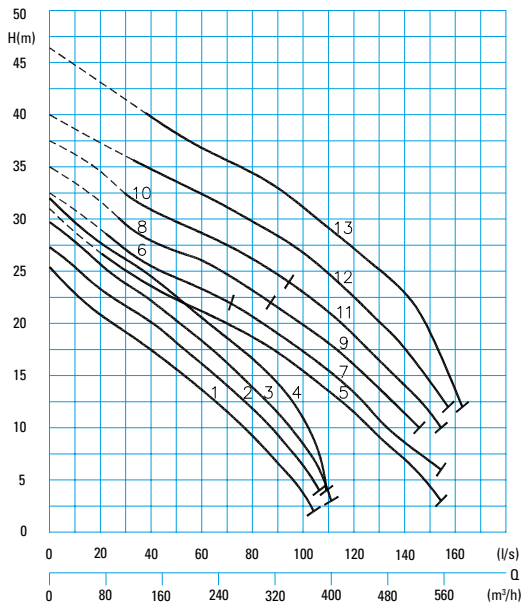

### Technical data

### WET WELL INSTALLATION

Curve No.	Pump type	Motor		Rated current (A)	Weight normal (kg)	Weight Ex (kg)
		P <sub>1</sub> (kW)	P <sub>2</sub> (kW)			
①	K 3352-P94 (C)(Ex)	17,0	14,6	28,8	216	228
②	K 3354-P94 (C)(Ex)	17,0	14,6	28,8	216	228
③	K 3356-P104 (C)(Ex)	22,0	19,3	36,5	234	246
④	K 3358-P104 (C)(Ex)	22,0	19,3	36,5	234	246
⑤	K 3360-F124 (C)(Ex)	29,1	25,6	51,4	418	418
⑥	K 3362-F124 (C)(Ex)	29,1	25,6	51,4	418	418
⑦	K 3362-F134 (C)(Ex)	32,8	29,2	59,0	428	428
⑧	K 3364-F134 (C)(Ex)	32,8	29,2	59,0	428	428
⑨	K 3364-F144 (C)(Ex)	37,1	33,0	67,1	449	449
⑩	K 3366-F144 (C)(Ex)	37,1	33,0	67,1	449	449
⑪	K 3366-G154 (C)(Ex)	41,1	37,4	70,4	486	486
⑫	K 3368-G154 (C)(Ex)	41,1	37,4	70,4	486	486
⑬	K 3370-G174 (C)(Ex)	50,1	46,1	84,3	528	528

### MOTOR OUTPUT

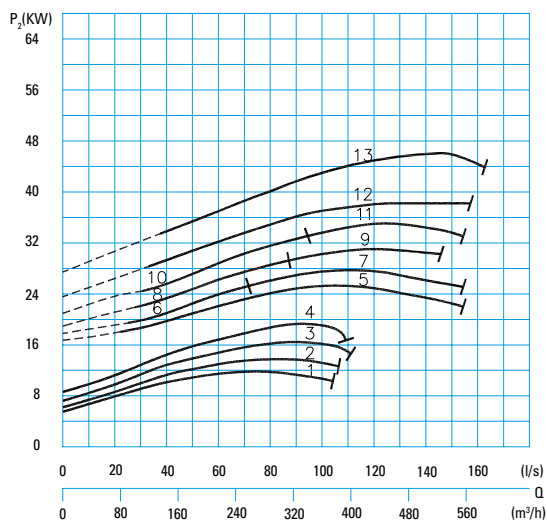

### Technical data

### DRY WELL INSTALLATION

Curve No.	Pump type	Motor		Rated current (A)	Weight normal (kg)	Weight Ex (kg)
		P <sub>1</sub> (kW)	P <sub>2</sub> (kW)			
①	K 3352-PU94 (Ex)	17,0	14,6	28,8	224	236
②	K 3354-PU94 (Ex)	17,0	14,6	28,8	224	236
③	K 3356-PU104 (Ex)	22,0	19,3	36,5	244	256
④	K 3358-PU104 (Ex)	22,0	19,3	36,5	244	256
⑤	K 3360-FU124 (Ex)	29,1	25,6	51,4	444	493
⑥	K 3362-FU124 (Ex)	29,1	25,6	51,4	444	493
⑦	K 3362-FU134 (Ex)	32,8	29,2	59,0	454	503
⑧	K 3364-FU134 (Ex)	32,8	29,2	59,0	454	503
⑨	K 3364-FU144 (Ex)	37,1	33,0	67,1	475	524
⑩	K 3366-FU144 (Ex)	37,1	33,0	67,1	475	524
⑪	K 3366-GU154 (Ex)	41,1	37,4	70,4	512	555
⑫	K 3368-GU154 (Ex)	41,1	37,4	70,4	512	555
⑬	K 3370-GU174 (Ex)	50,1	46,1	84,3	557	610

# DN 150 - K33...-6 POLE



## Enclosed two channel impeller

80 mm Ø Spherical clearance  
960 rpm



### HYDRAULIC PERFORMANCE

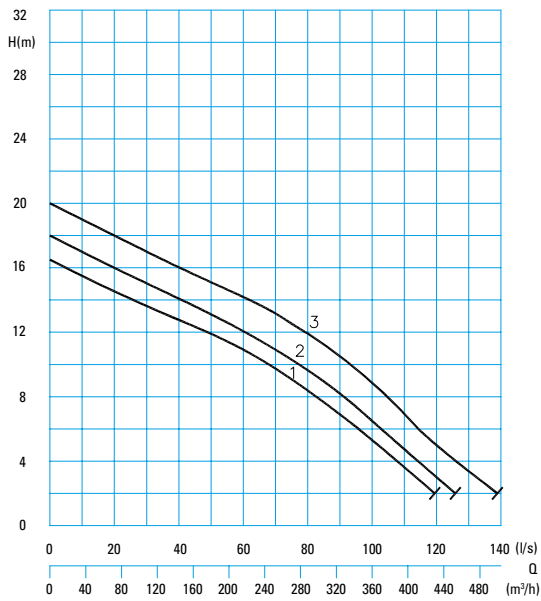

### Technical data

### WET WELL INSTALLATION

Curve No.	Pump type	Motor		Rated current (A)	Weight normal (kg)	Weight Ex (kg)
		P <sub>1</sub> (kW)	P <sub>2</sub> (kW)			
①	K 3366-P96 (C)(Ex)	16,0	13,6	29,4	280	292
②	K 3368-P96 (C)(Ex)	16,0	13,6	29,4	280	292
③	K 3370-P96 (C)(Ex)	16,0	13,6	29,4	280	292

### MOTOR OUTPUT

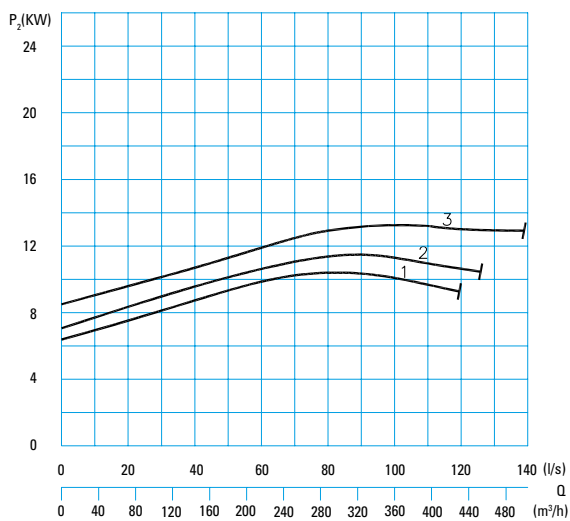

### Technical data

### DRY WELL INSTALLATION

Curve No.	Pump type	Motor		Rated current (A)	Weight normal (kg)	Weight Ex (kg)
		P <sub>1</sub> (kW)	P <sub>2</sub> (kW)			
①	K 3366-PU96 (Ex)	16,0	13,6	29,4	288	300
②	K 3368-PU96 (Ex)	16,0	13,6	29,4	288	300
③	K 3370-PU96 (Ex)	16,0	13,6	29,4	288	300

# DN 150 - VX 34...-4 POLE



## Vortex impeller

100 mm Ø Spherical clearance  
1450 rpm



### HYDRAULIC PERFORMANCE

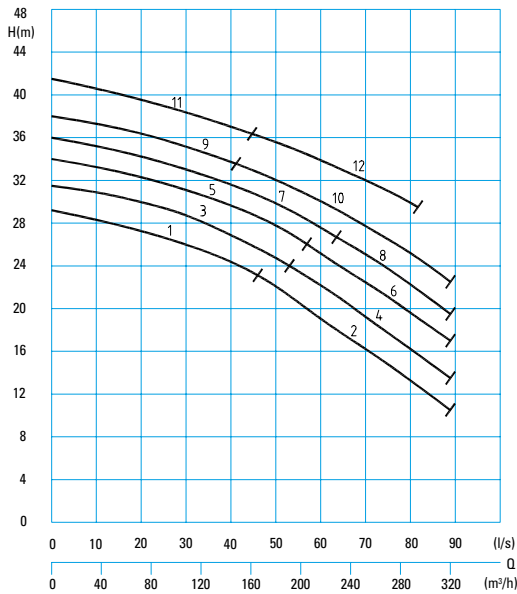

### Technical data

### WET WELL INSTALLATION

Curve No.	Pump type	Motor P <sub>1</sub> (kW)	Motor P <sub>2</sub> (kW)	Rated current (A)	Weight normal (kg)	Weight Ex (kg)
①	VX 3460-F114 (C)(Ex)	25,0	22,0	44,0	426	426
②	VX 3460-F124 (C)(Ex)	29,1	25,6	51,4	448	448
③	VX 3463-F124 (C)(Ex)	29,1	25,6	51,4	448	448
④	VX 3463-F134 (C)(Ex)	32,8	29,2	59,0	463	463
⑤	VX 3466-F134 (C)(Ex)	32,8	29,2	59,0	463	463
⑥	VX 3466-F144 (C)(Ex)	37,1	33,0	67,1	478	478
⑦	VX 3468-F144 (C)(Ex)	37,1	33,0	67,1	478	478
⑧	VX 3468-G154 (C)(Ex)	41,1	37,4	70,4	495	495
⑨	VX 3470-F144 (C)(Ex)	37,1	33,0	67,1	478	478
⑩	VX 3470-G174 (C)(Ex)	50,1	46,1	84,3	523	523
⑪	VX 3471-G154 (C)(Ex)	41,1	37,4	70,4	495	495
⑫	VX 3471-G174 (C)(Ex)	50,1	46,1	84,3	523	523

### MOTOR OUTPUT

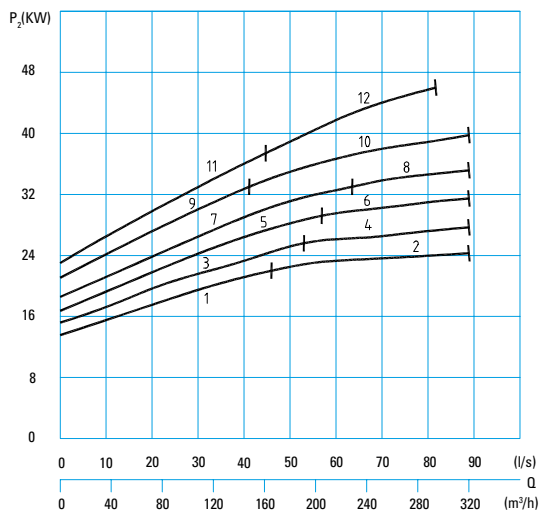

### Technical data

### DRY WELL INSTALLATION

Curve No.	Pump type	Motor P <sub>1</sub> (kW)	Motor P <sub>2</sub> (kW)	Rated current (A)	Weight normal (kg)	Weight Ex (kg)
①	VX 3460-FU114 (Ex)	25,0	22,0	44,0	447	447
②	VX 3460-FU124 (Ex)	29,1	25,6	51,4	474	474
③	VX 3463-FU124 (Ex)	29,1	25,6	51,4	474	474
④	VX 3463-FU134 (Ex)	32,8	29,2	59,0	489	489
⑤	VX 3466-FU134 (Ex)	32,8	29,2	59,0	489	489
⑥	VX 3466-FU144 (Ex)	37,1	33,0	67,1	504	504
⑦	VX 3468-FU144 (Ex)	37,1	33,0	67,1	504	504
⑧	VX 3468-GU154 (Ex)	41,1	37,4	70,4	521	521
⑨	VX 3470-FU144 (Ex)	37,1	33,0	67,1	504	504
⑩	VX 3470-GU174 (Ex)	50,1	46,1	84,3	552	552
⑪	VX 3471-GU154 (Ex)	41,1	37,4	70,4	521	521
⑫	VX 3471-GU174 (Ex)	50,1	46,1	84,3	552	552

# DN 150 - VX 34...-6 POLE



## Vortex impeller

100 mm Ø Spherical clearance  
960 rpm



### HYDRAULIC PERFORMANCE

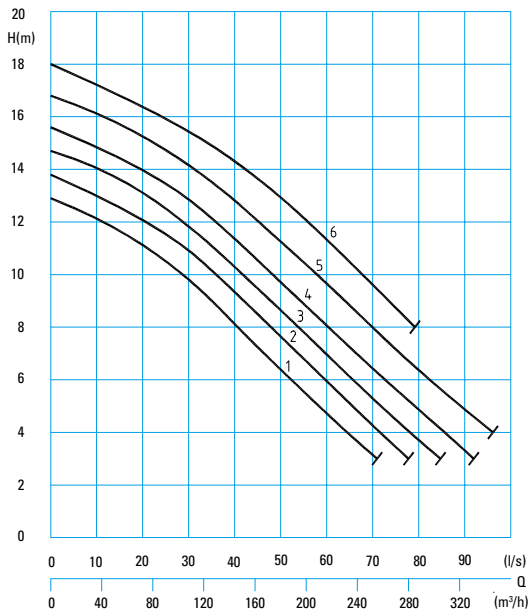

### Technical data

### WET WELL INSTALLATION

Curve No.	Pump type	Motor		Rated current (A)	Weight normal (kg)	Weight Ex (kg)
		P <sub>1</sub> (kW)	P <sub>2</sub> (kW)			
①	VX 3460-P76 (C)(Ex)	9,0	7,3	16,3	239	251
②	VX 3463-P86 (C)(Ex)	12,0	10,0	22,4	264	276
③	VX 3466-P86 (C)(Ex)	12,0	10,0	22,4	264	276
④	VX 3468-P86 (C)(Ex)	12,0	10,0	22,4	264	276
⑤	VX 3470-P96 (C)(Ex)	16,0	13,6	29,4	278	290
⑥	VX 3471-P96 (C)(Ex)	16,0	13,6	29,4	278	290

### MOTOR OUTPUT

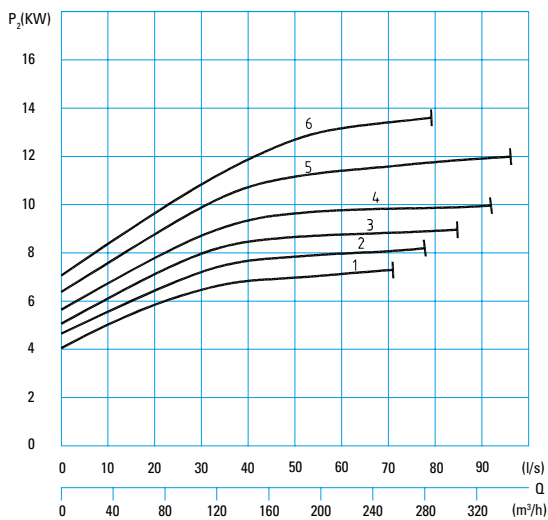

### Technical data

### DRY WELL INSTALLATION

Curve No.	Pump type	Motor		Rated current (A)	Weight normal (kg)	Weight Ex (kg)
		P <sub>1</sub> (kW)	P <sub>2</sub> (kW)			
①	VX 3460-PU76 (Ex)	9,0	7,3	16,3	245	257
②	VX 3463-PU86 (Ex)	12,0	10,0	22,4	274	286
③	VX 3466-PU86 (Ex)	12,0	10,0	22,4	274	286
④	VX 3468-PU86 (Ex)	12,0	10,0	22,4	274	286
⑤	VX 3470-PU96 (Ex)	16,0	13,6	29,4	291	293
⑥	VX 3471-PU96 (Ex)	16,0	13,6	29,4	291	293

# ACCESSORIES

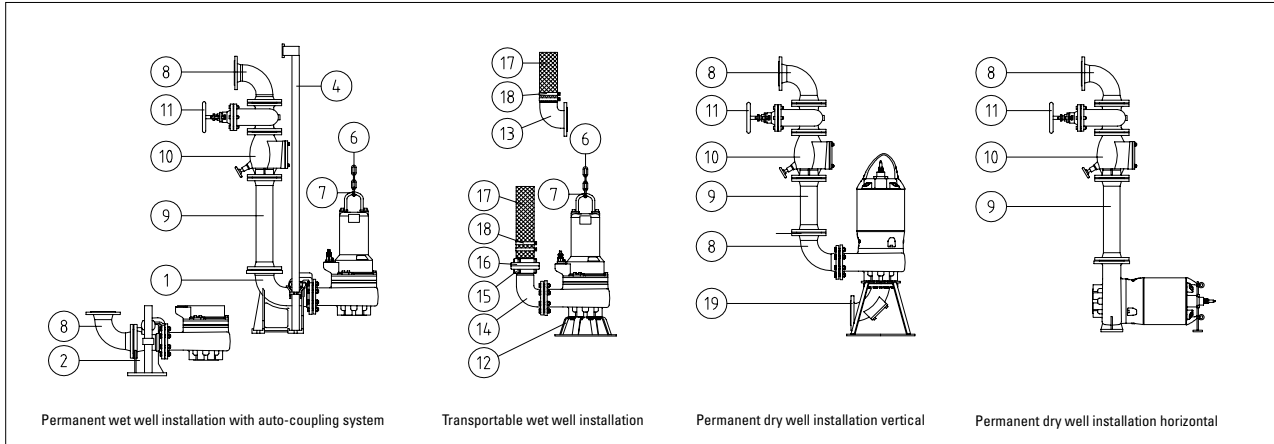

No.	Description	Type	Dimension	Part No.
1	<b>Auto-coupling system, cast iron, consisting of auto-coupling with flanged elbow, flanged pump coupling and upper slide rail bracket</b>  Execution (Material): - Cast iron	KK 80/80	DN 80	8604025
		KK 80/100	DN 80/DN 100	8604030
		KK 100/100	DN 100	8604055
		KK 100/80	DN 100 / DN 80	8604060
		KK 150/150	DN 150	8604070
	- Cast iron, upper slide-rail bracket - stainless steel	KKR 80/80	DN 80	8604026
		KKR 80/100	DN 80/DN 100	8604031
		KKR 100/100	DN 100	8604056
		KKR 100/80	DN 100 / DN 80	8604061
		KKR 150/150	DN 150	8604071
	- Complete stainless steel	KKC 80/80	DN 80	8604027
		KKC 100/100	DN 100	8604057
		KKC 150/150	DN 150	8604072
2	<b>Auto-coupling system consisting of auto-coupling with horizontal discharge flange, flanged pump coupling and upper slide rail bracket.</b>	KS 80/100	DN 80 / DN 100	8604045
		KS 100/100	DN 100	8604065
		KS 150/150	DN 150	8604075
		KS 200/150	DN 200 / DN 150	8604083
	<b>Intermittend slide rail</b> - Cast iron		1½" for DN 100	7322931
			2" for DN 150	7320121A
	- Stainless steel		2½" for DN 200	7322911
			1½" for DN 80	7323854A
			1½" for DN 100	7320355B
			2" for DN 150	7323974B
4	<b>Guide rails - pair, per meter</b>  Execution (Material): - Galvanized steel		1½" for DN 80/100	2190155
			2" for DN 150	2190205
			2½" for DN 200	2190225
	- Stainless steel		1½" for DN 80/100	2190254
			2" for DN 150	2190256
			2½" for DN 200	2190258
6 7	<b>Pump chain set</b>  - Single row, tested, load bearing capacity up to 320 kg Pitch 984 mm, 4x12 with shackle		2 m	2800362.02
			3 m	2800362.03
			4 m	2800364.04
			5 m	2800362.05
			6 m	2800362.06
			8 m	2800362.08
	<b>Pump chain set</b>  - Dual row, tested, load bearing capacity up to 320 kg Pitch 984 mm, 4x12 with shackle		4 m	2800367.04
			5 m	2800367.05
			6 m	2800367.06
			8 m	2800367.08
	<b>Pump chain set</b>  - Dual row, tested, load bearing capacity up to 560 kg Pitch 943 mm, 5x15 with shackle		4 m	2800365.04
			6 m	2800365.06

# ACCESSORIES

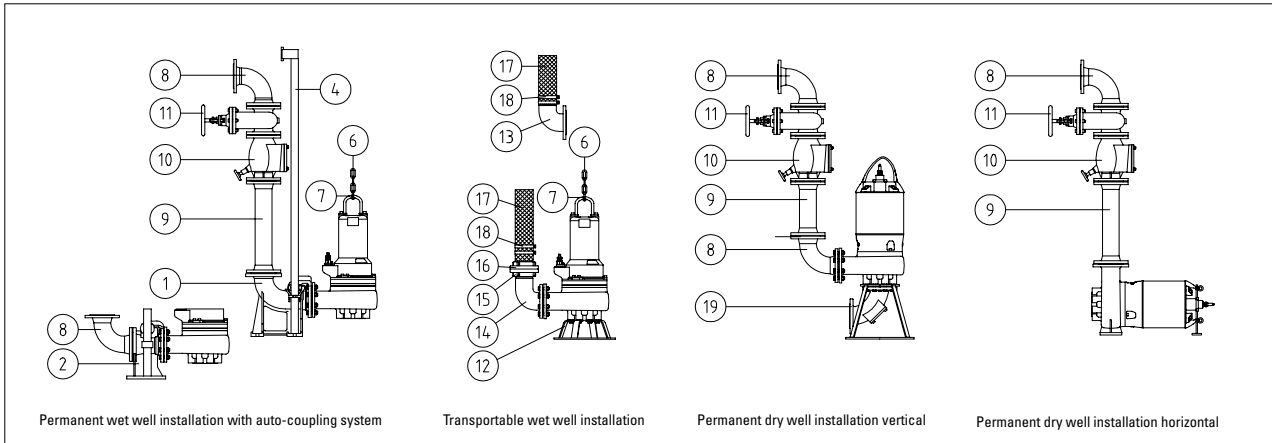

Permanent wet well installation with auto-coupling system

Transportable wet well installation

Permanent dry well installation vertical

Permanent dry well installation horizontal

No.	Description	Type	Dimension	Part No.
	<b>Pump chain set</b> - Dual row, tested, load bearing capacity up to 850 kg Pitch 998 mm, 6x18 with shackle		6 m	2800366.06
<b>8</b>	<b>90° flanged elbow</b> - with 2 flanges (Q-piece)		DN 80 DN 100 DN 150 DN 200	2153302 2153303 2153353 2153363
	- or flanged y-piece for twin pump arrangement, horizontal discharge (optional with vertical discharge) with gasket and fixing bolts		DN 80 / 80 / 80 DN 80 / 80 / 100 DN 100 / 100 / 100 DN 100 / 100 / 125 DN 100 / 100 / 150 DN 150 / 150 / 150 DN 200 / 200 / 200	on request
<b>9</b>	<b>Discharge pipe</b> - with 2 flanged (FF-piece) 1m, gasket and fixing bolts		DN 80 DN 100 DN 125 DN 150 DN 200	2152081 2152201 2152221 2152251 2152271
	<b>Discharge pipe</b> - per additional meter		DN 80 DN 100 DN 125 DN 150 DN 200	2150080 2150100 2150125 2150150 2150200
	- Flanged reducer (FFR-piece)		on request	
<b>10</b>	<b>Flanged swing check valve</b> - cast iron		DN 80 DN 100 DN 125 DN 150 DN 200	2212807 2212809 2212810 2212811 2212816
<b>11</b>	<b>Flanged gate valve</b> - cast iron		DN 80 DN 100 DN 125 DN 150 DN 200	2216080 2216100 2216125 2216150 2216200
<b>12</b>	<b>Ring base stand</b> - up to 16,9 kW (P2) - from 17,0 kW (P2)	NB 100 A NB 100 B NB 150 A NB 150	DN 100 DN 100 DN 150 DN 150	7321215 7321705 7321285 7321275
<b>13</b>	<b>Flanged spigot elbow</b> with gasket and fixing bolts		DN 100 / 100 mm	6001141
<b>14</b>	<b>90° Flanged elbow</b>		R3" IG/AG	2111805
	<b>Double nipple</b>		R3" AG	2128030
	<b>Threaded flange</b>		DN80 / R3" IG	2215080
	<b>Flanged to thread elbow</b> with gasket and fixing bolts		DN100 x R4" AG DN150 x R6" AG	6001121 6001205

# ACCESSORIES

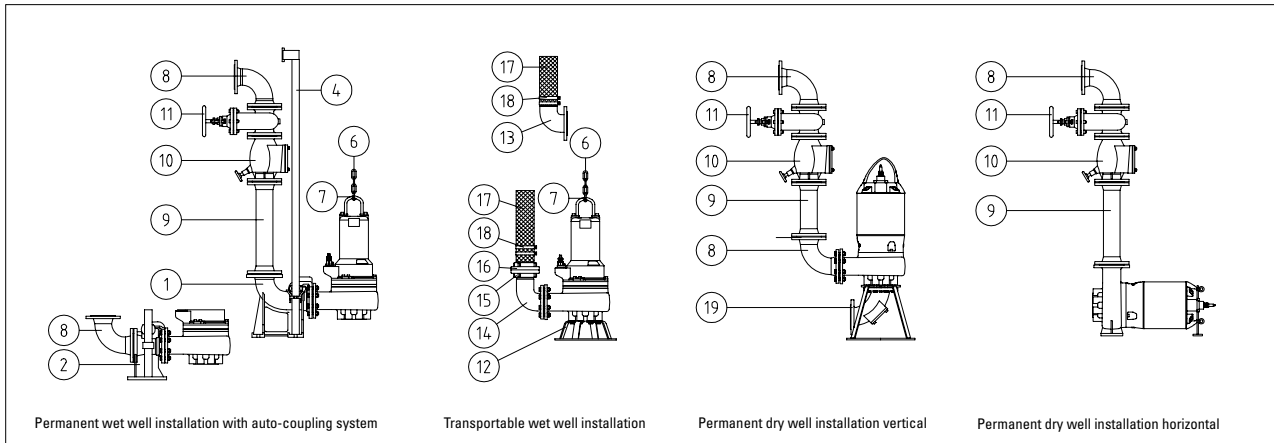

No.	Description	Type	Dimension	Part No.
15	STORZ-fixed coupling		B-R3" IG A-R4" IG F-R6" IG	2010602 2010701 2010961
16	STORZ-hose coupling with spigot		B - 75 mm A - 110 mm F - 150 mm	2013502 2013801 2013901
	STORZ-reducer		A-B F-A	2015612 2015622
17	Reinforced hose (inner dia. in mm)		75 mm 110 mm 150 mm	2632075 2632110 2632150
	Hose with pre-attached couplings		on request	
18	Hose bands		T 70-90-13 S100 / 20 GBS 112-121/25 GBS 168-174/30	2309013 2310020 2311520 2317520
19	Flanged pump stand with gasket and fixing bolts	TVS 100 A (up to 18 kW) TVS 150 A	DN 100 DN 150	7321705 7321725
	Pump stand with suction elbow, cleaning hole, gasket and fixing bolts	TVS 100 A-R (up to 18kW) TVS 100 A-R TVS 150 A-R TVS 150-R TVS 150/200 A-R TVS 150/200-R	DN 100 DN 100 DN 150 DN 150 DN 150 / DN 200 DN 150 / DN 200	8604220 8604221 8604225 8604230 8604232 8604235
	Screw kit with gaskets - galvanized steel		DN 80 DN 100 DN 150	2214080 2214100 2214150
	- Stainless steel		DN 80 DN 100 DN 150	2214082 2214102 2214152

Stainless steel pipes, fittings on request. Electrical or electronic control panels for pumps and pump stations with accessories on request. Sumps of concrete or synthetic material for complete pump stations please see special leaflet.



## HOMA

### Product Range

- Submersible waste water pumps
- Deep-well submersible pumps
- Submersible sewage pumps
- Submersible grinder pumps with cutter system
- Waste water disposal units
- Sewage disposal units
- Packaged pump stations
- Mixers and flow generators
- Injector systems for tank cleaning
- Garden pumps and domestic booster units
- Control boxes



### In operation worldwide

HOMA pumps and systems are employed in over 100 countries worldwide – in a myriad of projects, large and small, including the Palm Islands in Dubai. They meet all international safety and production standards and are certified by the relevant state or private bodies for waste water disposal.

It is one of our main objectives to maintain and extend this high standard at all times.



### Sales and service network

HOMA stays close to its customers through a comprehensive network of professional sales and service agencies.

HOMA also makes selecting and designing pump systems as straightforward as possible through HOP.SEL, our specially developed software, available free of charge online or on CD-ROM.

## HOMA Pumpenfabrik GmbH

Industriestraße 1 ➤ 53819 Neunkirchen-Seelscheid, Germany

Telefon: +49(0)2247/702-0 ➤ Fax: +49(0)2247/702-44

e-Mail: [info@homa-pumpen.de](mailto:info@homa-pumpen.de) ➤ Internet: [www.homa-pumps.com](http://www.homa-pumps.com)

