



ROBOT PUMPS



RS - GRINDER PUMPS

RS-Grinder Pumps

Sewage and Waste Water

The Robot submersible grinder pumps are designed for sewage and other waste water applications where the quantity of water does not allow the use of large solids passing discharge pipes. In order to allow the use of discharge pipes as small as 32 mm, large solids are effectively cut into small particles that can be pumped through such pipes without risk of blocking.

For many years, Robot grinder pumps are successfully applied in packaged pumping units and in pressure sewer systems for single house dewatering in areas

where gravity sewage systems cannot be used or will be too costly. Several pump stations can be connected to the same main discharge.

The high heads generated by the Robot grinder pumps enables the use of longer discharge pipes without the need for bigger motors. This feature makes the grinder pumps also ideal for applications where a limited quantity of water is needed with high pressure as for instance in agriculture to feed sprinkler installations or for washing and cleaning applications.

Features

Non- clog design

The robust cutting device installed in the suction opening of the pump effectively cuts larger solids into very small particles that can easily pass through the pump and will not block the discharge pipes.

makes these pumps also suitable for non-waste water applications where high heads are required with limited capacities, i.e. to feed filters or sprinklers.

Protected cutting edges

The main cutting edges are located inside the stationary cutting ring and thus protected from damage by heavy solids that cannot be cut. Rocks and similar solid particles will be thrown away from the grinder unit by the part of the cutter that extends just outside the stationary ring.

Hard stainless steel cutter

Both rotating and stationary part are made from a special hard stainless steel alloy to minimise corrosion and to ensure good cutting for a long period. In addition the rotor is surface hardened to extend life.

Small discharge pipes

The grinder pumps can be used with discharge pipes as small as 32 mm. Not only does this decrease the cost for the discharge pipe, but it also reduces the risk of sewage digesting in the discharge because remaining time of the sewage is much shorter.

Usually only a small gutter is required to lay the discharge. The pipes can easily follow the terrain.

High head - low power

The Robot RS grinder pumps generate an extreme high pressure at low flows with only limited motor power. This not only allows the use of longer discharge pipes, but it

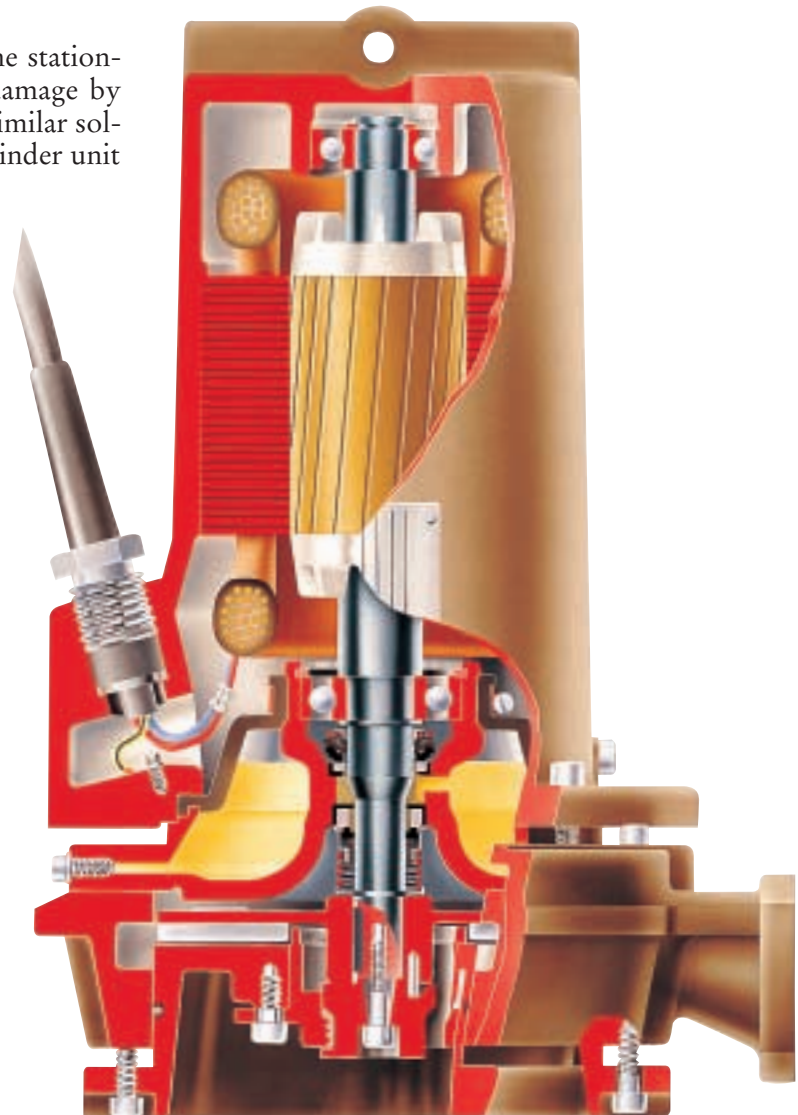

Characteristics

RS21 series

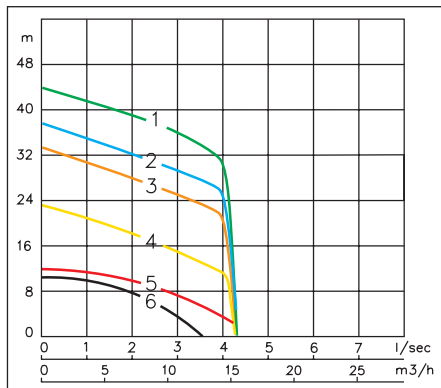

Nr	Model	Motor [kW]	Speed [min ⁻¹]	Outlet [mm]	A [mm]	B [mm]
1	RS2111BH	4.0	2900	40	295	420
2	RS2111BE	2.6	2900	40	295	420
3	RS2110BD	2.2	2900	40	295	420
4	RS2110BB	1.5	2900	40	295	420
5	RS2112DC	1.5	1450	40	295	420
6	RS2111DA	0.65	1450	40	295	390

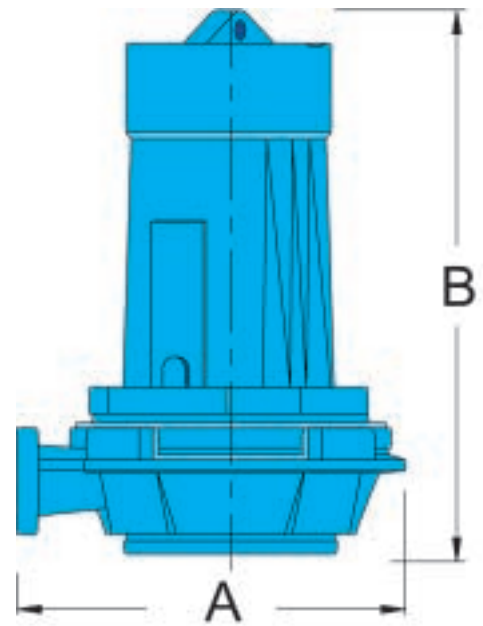

Options

Single phase motors: Available for the smaller models

Flame proof motors: certified to European standards WN 50014/18/19 (BS 5501), class EEx de IIB T3 or T4, and to American FMRC standard, class 1, division 1, groups C&D T4.

Seal leakage monitor: detects water ingress in both motor- and oil housing.

Thermostats: standard for all flameproof pumps and optional for all other pumps.

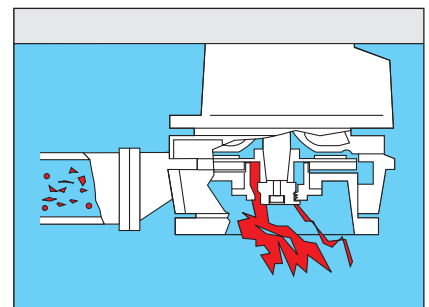

Design Features

Motor: class F (155°F/311°F).

Bearings: heavy duty, greased for life.

Shaft: stainless steel.

Shaft sealing: Two independent mechanical seals, run in oil. At the pump side silicon carbide runs on ceramic, at the motor side carbon on ceramic.

Oil housing: with flexible rubber bellows.

Back vanes: prevent solids entering the seal area and reduce the pressure on the seals for longer seal life.

Grinder: Effectively cuts larger solids into very small particles. Made from special hard stainless steel. Rotor additionally surface hardened.

Bolts & Nuts: stainless steel.



Options available

	Versions	
	1-phase	Flameproof
RS2111DA		
RS2112DC		●
RS2110BB	●	
RS2110BD		●
RS2111BE		●
RS2111BH		

Products from Robot Pumps B.V.:

Submersible pumps



- RW Vortex Pumps
- RT Turbotex Pumps
- RS Grinder Pumps
- RC Channel Pumps
- RD Slurry Pumps
- RV Heavy Duty Slurry Pumps

Pumps for dry installation

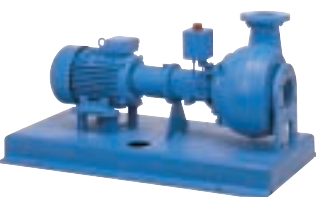

- BW Vortex Pumps
- BT Turbotex Pumps
- BD Slurry Pumps

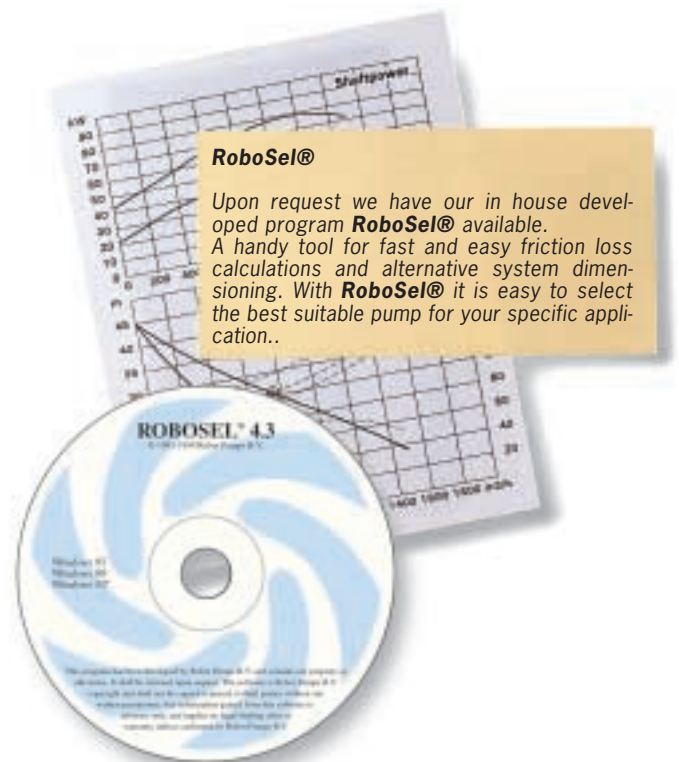

Typical applications

Sewage

Pressure sewage systems, compact prefab sewage treatment units, sewage treatment plants, sewage pumping stations, camping and other recreation facilities, shopping malls, hotels, restaurants, single house dewatering, manure.

Food processing and agriculture

Food and pet food factories, abattoir's, canneries, breweries and distilleries, meat and fish industrie, dairies.

Food waste, vegetable waste, slaughter waste, wash water, sprinkler water, kitchen waste.

General industry

Power plants, leather industry and textile mills.

Process and cooling water, washing water, filter water, sprinkler water.

Water control

Drainage and irrigation, water intake, tunnel drainage, parking and cellars dewatering, quarries, percolation water, ground water.



Options available

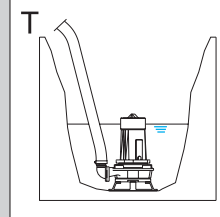
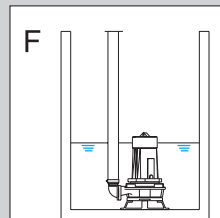
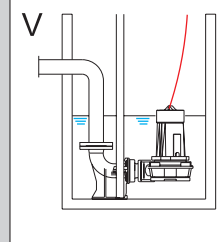
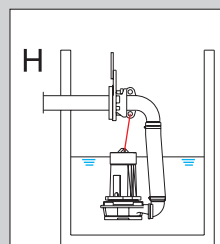

Pumps are available for permanent fixed installation, using the guide rail coupling V or the header coupling H, that is installed above the water level.

All pumps can be delivered for semi permanent free-standing installation F with stand and discharge adapter or for transportable use T.





ROBOT PUMPS

Robot Pumps B.V.

P.O. Box 140, 2400 AC Alphen aan den Rijn
Produktieweg 5, 2404 CC Alphen aan den Rijn
The Netherlands

Phone: +31 172 418686

Fax: +31 172 418602

E-mail: robot.pumps@metso.com

www.robotpumps.com