

1	Introduction and Safety	4
1.1	Introduction	
1.2	Safety	
1.2.1	Danger levels and safety symbols	
1.2.2	User safety	5
1.2.3	Ozone (O ₃)	6
1.2.4	UV-C	
1.2.5	Manganese dioxide (MnO ₂)	
1.2.6	Protection of the environment	7
1.2.7	Sites exposed to ionizing radiations	
2	Transportation and Storage	
2.1	Transportation of the packed product	
2.1.1	Inspect the delivery	
2.2	Handling the unit	8
2.3	Storage	
3.	Technical Description	
3.1	Description	
3.2	Denomination of the models	9
3.3	Data plate	
3.4	Denomination of the main components	
3.5	Intended use	
3.6	Improper use	
3.7	Use in water distribution networks for human consumption	
4	Installation	10
4.1	Mechanical installation	
4.1.1	Installation area	
4.1.2	Installation	
4.2	Hydraulic connection	
4.2.1	Guidelines for the hydraulic system	
4.3	Electrical connection	11
4.3.1	Grounding (earthing)	
4.3.1.1	Guidelines for electrical connection	
4.4	ORP probe	
4.5	Filters	
4.6	Start-up	12
5	Maintenance	13
5.1	Maintenance when specific error codes (messages) has been displayed or every year	
5.1.1	Filters	
5.1.1.1	Solid Particle Filter	
5.1.1.2	Inlet Filter	
5.1.1.3	Outlet Filter (HYDROINFINITY RESI only)	14
5.1.1.4	Catalytic Filter (HYDROINFINITY RESI only)	
5.1.2	UV-C lamp	
5.2	Spare parts	
5.3	Trouble shooting	15

Technical Appendix

Figure 1	Handling	16
Figure 2	Data plate	
Figure 3	Composition	17
Figure 4	Dimensions	18
Figure 5	Suggested Set Ups for Overflow System and Venting	
Figure 6	Suggested Set Ups for Overflow System and Venting	19
Figure 7	Valves and switches	20
Figure 8	Accessories	
Figure 9	ORP Probe	21
Figure 10	Filters installation	
Figure 11	Start-up	22
Figure 12	Menu structure	
Figure 13	Display	23
Figure 14	Draining/Filling	
Figure 15	Solid particle filter	24
Figure 16	Inlet filter	
Figure 17	Outlet filter	25
Figure 18	Catalytic filter	
Figure 19	UV lamp	
		26

Annex I	Ozone (REACH regulation)	27
Annex II	Manganese dioxide and copper oxide (REACH regulation)	28
Annex III	WEEE (waste of electrical and electronic equipment)	29
Annex IV	Technical Data	30
Annex V	Inbound Water Parametric Requirements	32
Annex VI	ORP probe	33
Annex VII	Error codes (messages)	34
Annex VIII	Spare parts and logbook	35
Annex IX	Original EU Declaration of Conformity	36



1 Introduction and Safety

1.1 Introduction

Purpose of this manual

The purpose of this manual is to provide necessary information for:

- Installation
- Operation
- Maintenance



CAUTION

Before installing and using the product, make sure that you read and fully understand this manual in all its parts. Improper use of the product can cause personal injuries and damage to property, as well as making the warranty null and void

NOTICE

This manual is an integral part of the product. It must always be made available to the user, stored in the proximity of the product, and well kept.

Supplementary instructions

The instructions and warnings in this manual apply to the standard version, as described in the sales document. Special versions may be supplied with supplementary instruction manuals. For situations not considered in this manual or in the sales document, contact Xylem or the Authorised Distributor.



1.2 Safety

1.2.1 Danger levels and safety symbols





Before using the product, and in order to avoid the following risks, make sure that you carefully read, understand and comply with the following danger warnings:









- Injuries and health hazards
- Damage to the product
- Product malfunction.

Hazard levels







Hazard level	Indication
 DANGER	It identifies a dangerous situation which, if not avoided, causes serious injury, or even death.
 WARNING	It identifies a dangerous situation which, if not avoided, may cause serious injury, or even death.
 CAUTION	It identifies a dangerous situation which, if not avoided, may cause small or medium level injuries.
NOTICE	It identifies a situation which, if not avoided, may cause damage to property but not to people.

Complementary symbols

Symbol	Description
	Electrical hazard.
	Magnetic hazard.
	Hot surface hazard.
	Ionizing radiation hazard.
	Potentially explosive atmosphere hazard in working areas (EU ATEX directives).

	Cut and/or abrasion hazard.
	Crushing hazard (limbs).
	Ultraviolet radiation hazard (UV-C).
	Ozone Danger: May cause or intensify fire; oxidiser.
	Ozone Warning: May cause damage to organs through prolonged or repeated exposure.
	Ozone Warning: Causes serious eye irritation. Suspected of causing genetic defects. Causes skin irritation. May cause respiratory irritation.
	Ozone Danger: Fatal if inhaled.
	Ozone Warning: Very toxic to aquatic life.

Other symbols

Symbol	Description
	User Specific information for the users of the product.
	Installer / Maintenance technician Specific information for personnel responsible for the installation of the product within the system (hydraulic and/or electric system), and for maintenance operations.
	ATEX Product information for use in potentially explosive atmospheres (EU ATEX directives).
	Reading the instruction manual/booklet before starting work or before operating equipment or machinery.
	Protective gloves must be worn.
	Do not move or lift by hand.
	WEEE - waste electrical and electronic equipment

1.2.2 User safety

Strictly comply with current health and safety regulations.

**WARNING**

This product must be used only by qualified users.

Qualified users are people able to recognise the risks and avoid hazards during installation, use and maintenance of the product.

Inexperienced users**WARNING****FOR THE EUROPEAN UNION**

- This product can be used by children aged from 8 years and above and persons with reduced physical, sensory or mental capabilities or lack of experience and knowledge if they have been given supervision or instruction concerning use of the appliance in a safe way and understand the hazards involved.
- Children shall not play with the appliance.
- Cleaning and user maintenance shall not be made by children without supervision.

FOR OTHER COUNTRIES

- This product is not intended for use by persons (including children) with reduced physical, sensory or mental capabilities, or lack of experience and knowledge, unless they have been given supervision or instruction concerning use of the appliance by a person responsible for their safety.
 - Children should be supervised to ensure that they do not play with the appliance.
-

1.2.3 Ozone (O₃)

When properly installed, the ozone (O₃) used in the appliance is contained within the system and any excess is vented to the outside atmosphere by the overflow pipework and reverts naturally to oxygen (O₂). Always ensure the appliance is operated with the lid closed and with the combined overflow/ vent pipe vented to outside. In the event of an ozone gas escape and build up within the building, switch off the appliance and ventilate the area.



DANGER

- Ozone gas has a strong characteristic smell.
- Prolonged exposure to high concentrations of ozone gas can cause headaches and illness.



Exposure to ozone above 0.10 ppm (parts per million) for eight hours per day could be dangerous and should be avoided.



Symptoms: problems associated with ozone gas exposure include lung irritation and infection, breathing pain, coughing, wheezing, headaches, minor eye, nose and throat irritation, permanent lung damage.



First Aid: For mild exposure – leave affected area and breath some fresh air until breathing has returned to normal. If breathing problems continue seek medical attention for oxygen inhalation. For severe exposure – seek medical attention immediately.



REACH - Regulation (EC) No 1907/2006 on Chemicals: please refer to Annex I of the Technical Appendix.

1.2.4 UV-C

Germicidal UV cannot pass through clothing or other opaque or clear materials such as plastics or window glass.



WARNING

- The appliance contains an active germicidal UV-C lamp. UV-C radiation is dangerous for the eyes and skin even in small doses.
- When the system is active, this lamp must remain contained and sealed within the generator. Never look at the lamp while it is operating.
- Do not power UV lamp outside of the generator.
- Using the appliance with damaged generator housing may result in the escape of UV radiation. If the generator housing is obviously damaged the appliance must NOT be operated.



Exposure to UV light results in symptoms that develop slowly, the exposure cannot be felt at the time.

Symptoms: Eyes: Mild exposure – irritation developing several hours later.
Severe exposure – sore, red eyes, sensitive to light, painful to keep eyes open.
Skin: Mild exposure – slight reddening, tenderness, mild sunburn symptoms.
Severe exposure – skin peeling, weeping area, severe sunburn symptoms.

First Aid: Eyes: In mild cases, cover eyes and seek medical attention. Severe cases seek immediate medical attention.
Skin: In mild cases removal from exposure may be sufficient. If in doubt seek medical attention. In severe cases, seek immediate medical attention.



Cotton gloves should be worn at all times when removing and touching the UV lamp.

1.2.5 Manganese dioxide (MnO₂)

The Outlet Filter for HYDRO INFINITY RESI contains a mixture with around 80% of Manganese dioxide. Even the Catalytic filter, supplied on request for HYDROINFINITY RESI, contains a mixture with that substance and copper oxide.

**DANGER**

- Prolonged exposure can cause illness.



REACH - Regulation (EC) No 1907/2006 on Chemicals: please refer to Annex II of the Technical Appendix.

1.2.6 Protection of the environment**Disposal of packaging and product**

Comply with the current regulations on sorted waste disposal.



From 15 August 2018

WEEE – waste of electrical and electronic equipment: please refer to Annex III of the Technical Appendix.

Leaking of fluid

If the product contains lubricating fluid, take appropriate measures to prevent the dispersal of leaks into the environment.

1.2.7 Sites exposed to ionizing radiations**WARNING**

If the product has been exposed to ionizing radiations, implement the necessary safety measures for the protection of people. If the product needs to be despatched, inform the carrier and the recipient accordingly, so that appropriate safety measures can be put in place.

**2 Transportation and Storage****2.1 Transportation of the packed product**

The Manufacturer delivers the product and its components in a cardboard box with wooden base. Please, refer to Fig. 1 of the Technical Appendix.

**WARNING**

The appliance is

- The product and its components may be heavy: risk of crushing
- Always wear personal protective equipment
- Check the gross weight marked on the packaging and use suitable lifting equipment.

**CAUTION**

- The appliance is NOT designed to be moved or lifted by hand.
- The use of a trolley/forklift truck is the only recommended means of moving or handling the appliance.
- It weighs approximately 55 kg empty and has a low centre of gravity.

**WARNING**

If the product is designed to pump water for human consumption, take appropriate measures during transport to avoid contamination from external substances.

2.1.1 Inspect the delivery**Inspect the package**

1. Check that quantity, descriptions and product codes match the order.
2. Check the packaging for any damage or missing components.
3. In case of immediately detectable damage or missing parts:
 - accept the goods with reserve, indicating any findings on the transport document, or
 - reject the goods, indicating the reason on the transport document.
 In both cases, promptly contact Xylem or the Authorised Distributor from whom the product was purchased.

Unpacking and inspection of the product

1. Remove packing materials from the product.
2. Release the product by removing the screws and/or cutting the straps, if fitted.



CAUTION

Always wear personal protective equipment.



3. Check the product for integrity and to make sure that there are no missing components.
4. In case of damage or missing components, promptly contact Xylem or the Authorised Distributor.

2.2 Handling the unit



CAUTION

- The appliance is NOT designed to be moved or lifted by hand.
- The use of a trolley/forklift truck is the only recommended means of moving or handling the appliance.
- Do not attempt to move the appliance full.
- Drain the appliance of water before attempting to move it and always use appropriate lifting and handling equipment.
- It weighs approximately 55 kg empty, 300kg when full with water, and has a low centre of gravity.



WARNING

- During the lifting operations, always avoid sudden movements that could compromise the stability of the load.
- During handling, make sure to avoid injury to people and animals, and/or damage to property.



2.3 Storage

Storage of the packed product

The product must be stored:

- in a covered and dry place;
- away from heat sources;
- protected from dirt;
- protected from vibrations;
- at an ambient temperature between -5°C and +40°C (23°F and 104°F).

NOTICE

- Do not place heavy loads on top of the product
- Protect the product from collisions



WARNING

If the product is designed to pump water for human consumption, take appropriate measures during transport to avoid contamination from external substances.

Long-term storage of the unit

Follow the same instructions for storage of the packaged product.

For further information about preparation for long-term storage, please contact Xylem or the Authorised Distributor.

3. Technical Description



3.1 Description

Appliance for water disinfection and control of the broad spectrum of microorganisms by means of UV rays and oxidising agent generated on-site.

The first part of the treatment involves the filtration of the water through a solid particle filter, followed by a 5 micron particle filter. Following this, the UV sanitises the water which is then stored in the 230 litres tank, ready for use. In order to maintain water quality, the ozone diffuser bubbles ozone into the stored water in the tank.

When the water is required, the outlet pump is actAnnex ated and the water is delivered where needed, directly (HYDROINFINITY AGRI-5/A) or passing through a final phase of filtration in order to remove the residual ozone prior to use (HYDROINFINITY RESI-5/A).

3.2 Denomination of the models

Model	Description
HYDROINFINITY AGRI-5/A	Appliance designed to treat water used or intended to be used for animal consumption purposes.
HYDROINFINITY RESI-5/A	Appliance designed to treat water used or intended to be used for drinking, food preparation and bathing purposes.

3.3 Data plate

Please, refer to Fig. 2 of the Technical Appendix.

3.4 Denomination of the main components

Please, refer to Fig. 3 of the Technical Appendix.

3.5 Intended use

HYDROINFINITY AGRI-5/A

Treatment of source water (see 'Technical Data' in Annex IV) used or intended to be used for animal consumption purposes, where/when is likely the presence of microbiological impurities to be, by reducing it to an amount not sufficient to cause disease or harmful effects.

HYDROINFINITY RESI-5/A

Treatment of source water (see 'Technical Data' in Annex IV) used or intended to be used for drinking, food preparation and bathing purposes, where/when is likely the presence of microbiological impurities to be, by reducing it to an amount not sufficient to cause disease or harmful effects.

NOTE The appliance is designed with the capacity to treat up to 2700 l/day. Before installing it, the installer must be aware of the expected usage pattern and the expected daily volume and must advise the customer about the water usage limits.

3.6 Improper use



WARNING

The product was designed and built for the use described in the section Intended use. It is strictly prohibited to put the product to any other use, in order to guarantee the safety of the user and the efficiency of the same product at all times.



DANGER

The operation of the appliance in environments with potentially explosive atmospheres or with combustible dusts (e.g.: wood dust, flour, sugars and grains) is strictly forbidden.



CAUTION

The water treated by HYDROINFINITY AGRI is not for the human consumption.

WARNING

The water treated by HYDROINFINITY AGRI or RESI is not suitable for health care use (medical/surgical).

In no way (either express or implied) shall treated water be deemed to mean treated source water that is free (either to a greater or lesser extent) from chemical contaminants or other impurities.

Ozone Industries Ireland Ltd take no responsibility for the quality of water once it enters the distribution network (commercial, domestic and so on).

Examples of improper use

- Use HYDROINFINITY AGRI in the place of HYDROINFINITY RESI and vice versa.

Examples of improper installation

- Areas where the air temperature is very high and/or there is poor ventilation.
- Outdoor.

3.7 Use in water distribution networks for human consumption

Be careful when connecting the appliance to a public or private aqueduct, or to a well for the supply of water for human and/or animal consumption.



WARNING

- Take appropriate measures during transport and storage to prevent contamination from external substances.
 - Remove the appliance from its packaging soon before installation and make sure that it does not become contaminated.
 - After installation, run the appliance for a few minutes with several users open in order to wash the inside of the system.
-

4. Installation



Precautions

Make sure you have read and understood the safety instructions in the Introduction and Safety chapter before starting work.



WARNING

- Always wear personal protective equipment
 - Always use suitable working tools
 - When selecting the place of installation and connecting the unit to the hydraulic and electric power supplies, strictly comply with current regulations.
-

Be careful when connecting the appliance to a public or private aqueduct, or to a well for the supply of water for human and/or animal consumption.



WARNING

- Remove the appliance from its packaging soon before installation and make sure that it does not become contaminated.
 - Observe all the requirements of the authorities and companies concerned.
-

Pay attention to small cardboard box supplied with the appliance which contains accessories. Handle it with care.

4.1 Mechanical installation

4.1.1 Installation area

- The appliance must be installed in a clean, dry room.
- DO NOT place it in direct sunlight, conservatory, sunroom etc.
- The appliance must be installed on a flat, horizontal load bearing floor; the floor must support the appliance weight of 300 kg when full.
- The appliance must be well clear from anything that can damage or interfere with it (e.g. Boiler).
- As there is a risk of water spills during installation the installer must take the necessary precautions so that the water does not affect anything around the appliance.
- As there is a risk of ozone contamination the installer must ensure the room is ventilated and the ozone will be vented safely to the outside.
- There should be minimal risk of re-entry of ozone from the outside environment.

See 'Technical Data' in Annex IV for further information.

4.1.2 Installation

The appliance does not need to be anchoring to the floor/foundation.

It must be installed with a minimum of 25 mm from the back wall (Fig. 3 of the Technical Appendix).

4.2 Hydraulic connection



WARNING

- All the hydraulic connections must be completed by an installer possessing the technical-professional requirements outlined in the current regulations.
 - Use pipes of a suitable size that can withstand the maximum operating pressure; the system may otherwise collapse and pose the risk of physical injury and damage to property.
 - All the pipes and fittings that come in contact with treated water must be ozone resistant.
-

4.2.1 Guidelines for the hydraulic system

- Please, refer to Fig. 4 of the Technical Appendix about pipes diameters and positions.
Please, refer to Fig. 5 and 6 of the Technical Appendix about overflow system and venting.
- The water distribution pipe network is in good condition and clean.
- If using rainwater as the source water you should have an appropriate rain harvesting system that uses a first flush diverter, calmed inlet and floating suction.

- Elevation of the highest water withdrawal outlet must be no higher than 15 m above the elevation of the appliance footing; otherwise the outlet pump controller will need to be adjusted (see *Lowara Genyo Pump Controller Manual*).

The appliance is supplied with on/off valves closed. DO NOT OPEN them before installing ORP probe and filter(s).

4.3 Electrical connection



DANGER

- The connection to the electric power supply must be completed by an electrician possessing the technical-professional requirements outlined in the current regulations.
- Before starting work, check that the appliance is unplugged and cannot restart, even unintentionally.



4.3.1 Grounding (earthing)



DANGER

- Always connect the external protection conductor to the ground terminal before attempting to make any other electrical connections.
- Check that the protection conductor (ground/earth) is longer than the phase conductors; in case of accidental disconnection of the power supply conductor, the protection conductor (ground) must be the last one to detach itself from the terminal.
- Install suitable systems for protection against indirect contact, in order to prevent lethal electric shocks.



4.3.1.1 Guidelines for electrical connection

- Check that the electrical leads are protected against high temperature, vibrations, collisions.
- Check that the power supply line is provided with
 - a 30mA RCD (residual current device),
 - a short circuit protection device of appropriate size,
 - a mains isolator switch with a contact gap of at least 3 mm.
- The appliance is provided with a 2,5-meter long H05VV-F 3G1 power cable (without plug) to be connected permanently to the mains. The cable is connected to the appliance through an IEC connector. DO NOT USE this connector to disconnect the appliance from the power line.
- Connect the protection conductor (ground/earth) at first. Then connect the phase leads.

4.4 ORP probe



Gloves should be worn. DO NOT TOUCH the glass or the tip of the probe.

1. After connecting the inlet, outlet and overflow pipes, remove the appliance cover paying attention to not lose fixing screws.
2. Check if on/off valves are closed (Please, refer to Fig. 7 of the Technical Appendix).
3. Open the cardboard box supplied with the appliance which contains accessories and take the ORP probe in its box (Please, refer to Fig. 8 of the Technical Appendix).
4. Remove the plastic cap, ensure the O-ring is fitted and the probe has enough buffer solution (Please, refer to Fig. 9 of the Technical Appendix).
5. Screw the probe in by hand until you feel confident that water can't leak.
6. Pass the cable through the appliance until it reaches the control panel.
7. Insert the connector in the control panel.

4.5 Filters



Always wear clean gloves (powder free) to avoid possible contamination of filters (separate pair for dirty and clean filters).

1. Open the cardboard box supplied with the appliance which contains accessories and take filter cartridges and housings (Please, refer to Fig. 8 of the Technical Appendix).
2. Insert cartridges into the housings (Please, refer to Fig. 10 of the Technical Appendix).
3. Take the wrench (spanner) placed in the appliance.
4. Screw the housings by hand until you feel confident that water can't leak.
5. Except for Solid Particle Filter, use the wrench (spanner) to secure correct closing
6. Put the wrench (spanner) back in the appliance.

The catalytic filter, supplied on demand for HYDROINFINITY RESI, shall be installed along the PVC overflow/drainage pipe.

1. Prepare the piping (Please, refer to Fig. 10 of the Technical Appendix).
2. Open the cardboard box which contains filter.
3. Screw the filter.

4.6 Start-up

1. Open all the valves except for the Outlet Valve (Please, refer to Fig. 11 of the Technical Appendix).
2. Run commissioning mode.

The system will guide you through the steps below. This should take about 30 minutes to complete. Water will not be available until all steps are completed. You will need to follow this procedure only once. In the event that you interrupt the procedure by powering off the appliance or the machine displays an error you will be prompted to restart the commissioning process

 - Turn ON the appliance. The switch is located on the bottom side of the control panel.
 - The control panel will display the Commissioning mode screen containing the software version number. Press OK (Please, refer to Fig. 7, letter B, Fig. 12 and 13 of the Technical Appendix).
 - The language selection screen will be displayed, choose “English”. The control panel will ask you to confirm your choice, press OK.
 - The control panel will display the set time screen. Set the correct time. The control panel will ask you to confirm your choice, press OK.
 - The control panel will display the set date screen. Set the correct date. The control panel will ask you to confirm your choice, press OK.
 - On the next screen “Calibrate Ozone sensor” is displayed. Press Ok. The ozone sensor will then be calibrated. This will take 60 seconds.
 - Once ozone sensor calibration is complete a menu will be displayed. Select the start commissioning option.
 - The next screen will display the appliance Status, ORP value, LPM (litres per minute) and current water level (L) in litres.
 - At this point a fill will be carried out,
 - a. The status will change from “Inactive” to “Warmup” for 35 seconds.
 - b. After warmup the status will change to “Fill”. At this point the machine will fill to 220 litres.
 - c. Once 220 litres is reached the status will change to “Cooldown” for 30 seconds.
 - d. After cooldown the status will change to “Ozone On”. At this point the ozone level will rise to 700 and two minutes later the status will change back to “Inactive”.

NOTE There will be a 20 seconds delay on power up before the fill process starts.

- After the fill has been completed a DAF (dissolved air flotation) fill will be carried out,
 - a. The status will change from “Inactive” to “Warmup” for 35 seconds.
 - b. After warmup the status will change to “Fill for 90 seconds.
 - c. After this the status will change to “Cooldown” for 30 seconds.
 - d. After cooldown the status will change to ozone on for two minutes and the status will change back to inactive.
 - Once fills have been completed the question “Confirm checked for leaks” will be displayed. Once checked press OK.
 - You will be prompted to enter the control panel pin number. Enter the correct pin and press ENTER.
(The PIN number is displayed in a label on control panel)
 - The control panel will then display “Pin OK”.
 - Cycle the power to the appliance (switch off/on).
 - The commission process is now complete and the appliance is in run mode.
 - TURN ON the Outlet Valve before using the appliance.
3. Connect the appliance to Internet.
 - Remove control knob from control panel.
 - Remove control panel front cover.
 - Remove Wi-Fi ® module from logic board.
 - Plug Wi-Fi ® module into programming card.
 - Plug card USB lead into computer
 - Open RS Wi-Fi ® programme on computer
In the software window of the RS Wi-Fi programme;
 1. Open port
 2. Enter SSID and passkey for broadband network
 3. “configure” will pop on the screen
 4. On bottom of window you will see the following
 5. “ set ok?” - press the button
 6. “success” will show on the screen when correctly configured.
 - Return module to control panel and refit cover and knob.

NOTE It is advised to flush out the system and pipework by running a tap to empty the appliance of the first volume of water and then allowing the appliance to re-fill before commencing normal use.

At the end fix the appliance cover.



WARNING

The appliance is designed to keep the water clean as long as it is ON. If you know it is going to be powered down for a long period of time you need to drain the tank and remove and discard the inlet filter BEFORE leaving. If the appliance is not in use for a long period of time you need to drain it and change the inlet filter.

Please, refer to Fig. 14 of the Technical Appendix on how draining or filling the appliance.

5 Maintenance



Precautions

Make sure you have read and understood the safety instructions in the Introduction and Safety chapter before starting work.

NOTE After replacing one or more components, make treated water flow for some minutes addressing it to a drain, before reusing it in the distribution system.



WARNING

- Maintenance must be done by a technician possessing the technical-professional requirements outlined in the current regulations.
- Always wear personal protective equipment.
- Always use suitable working tools.
- Make sure that the drained liquid cannot cause damage or injuries.



DANGER

Before starting work, check that the appliance is unplugged and cannot restart, even unintentionally.



DANGER

HYDROINFINITY AGRI only

This appliance is provided with two Air Dryers and especially one of them could be touchable when front cover is removed. Although it is insulated and may appear cool, it can be very hot under the insulation as operates at high temperatures. Be careful to not touch it with any part of body and to avoid that any combustible materials can come in contact with it. Do not attempt to touch or remove air dryer during operation. In case of replacement, wait sufficient time for it to cool down before removal.



5.1 Maintenance when specific error codes (messages) has been displayed or every year

About error codes, please, refer to Annex VII of the Technical Appendix.

5.1.1 Filters



WARNING

NEVER run the appliance without filters.



Always wear clean gloves (powder free) when putting in new filtering cartridges to avoid possible contamination of filters (separate pair for dirty and clean filters).

Remove the appliance cover paying attention to not lose fixing screws.

Turn off the power and close the inlet and outlet valves.

At the end put the wrench (spanner) back in the appliance.

5.1.1.1 Solid Particle Filter

1. Unscrew the housing by hand (Please, refer to Fig. 15 of the Technical Appendix).
2. Remove and wash the filtering cartridge with clean cold water.
3. Wash the housing with clean cold water.
4. Make sure the O-rings on the filter housing and on cartridge are clean and properly seated.
5. Screw back the housing with the filtering cartridge inside by hand until you feel confident that water can't leak.

5.1.1.2 Inlet Filter

1. Use the wrench to unscrew the filter housing (Please, refer to Fig. 16 of the Technical Appendix).
2. Remove the used filtering cartridge (PA wounded wire). Follow local regulation about its disposal.

3. Wash the filter housing with clean cold water.
4. Remove new filtering cartridge from its package and insert it in the housing.
5. Make sure the O-ring on the filter housings are clean and properly seated.
6. Screw back the housing with the filtering cartridge inside by hand tightening, then use the wrench (spanner) to secure correct closing.
7. Open the two valves and turn the appliance on again (excepted for HYDROINFINITY RESI, see next paragraph).
8. On the control panel navigate to: Home screen > Settings Menu > (Insert Pin) > Reset Filter.

5.1.1.3 Outlet Filter (HYDROINFINITY RESI only)

Normally inlet and outlet filters should be subject to maintenance at the same time.

1. Close the valve in pump outlet (Please, refer to Fig. 17 of the Technical Appendix).
2. Use the wrench to unscrew the filter housing.
3. Remove the used filtering cartridge (granular manganese dioxide). Follow local regulation about its disposal.
4. Wash the filter housing with clean cold water.
5. Remove new filtering cartridge from its package and insert it in the housing.
6. Make sure the O-ring on the filter housings are clean and properly seated.
7. Screw back the housing with the filtering cartridge inside by hand tightening, then use the wrench (spanner) to secure correct closing.
8. Open all valves and turn the appliance on again.
9. On the control panel navigate to: Home screen > Settings Menu > (Insert Pin) > Reset Filter.

5.1.1.4 Catalytic Filter (HYDROINFINITY RESI only)

Since placed outside of the appliance it is not necessary to remove the appliance cover but remember to turn off the power.

1. Remove the used filter (granular manganese dioxide and copper oxide). Follow local regulation about its disposal. (Please, refer to Fig. 18 of the Technical Appendix).
2. Remove new filter from its package.
3. Screw it in the piping.

5.1.2 UV-C lamp



WARNING



- The UV lamp should be handled with great care. The lamp is not warranted against breakage and damage. Always install the lamp in a careful manner, not at an angle which could cause damage to the quartz glass sleeve inside the generator.
- In the event of damage to the UV lamp or quartz glass sleeve, contact your approved technical installer and DO NOT USE the water.
- DO NOT dispose of lamp with domestic waste as it contains a small amount of mercury. Follow local regulation about its disposal.



Always wear clean cotton gloves (powder free) when removing and touching the UV lamp to avoid possible contamination.

1. Remove the appliance cover paying attention to not lose fixing screws.
2. Turn off the power and close the inlet and outlet valves.
3. Gently disconnect the ceramic plug from the lamp at the top of the generator (Please, refer to Fig. 19 of the Technical Appendix).
3. Remove the black plastic lock nut from the top of the generator by turning anticlockwise.
4. Carefully withdraw the lamp from the generator by lifting it out.
5. Remove new lamp from its package.
6. Carefully insert the new lamp and make sure lamp sits properly. Do not touch the lamp glass.
7. Re-attach and hand-tighten the black plastic lock nut by turning clockwise.
8. Connect the lamp cable plug onto lamp.
8. Open the two valves and turn the appliance on again.
9. On the control panel navigate to: Home screen > Settings Menu > (Insert Pin) > Reset Lamp.

5.2 Spare parts

When replacing any part of the product use only H2ozone spare parts and not reconditioned or copy parts that have not been clearly authorised by H2ozone. Failure to do so could compromise the performance and/or safety of the machine and invalidate the warranty.

Please, refer to Annex VIII of the Technical Appendix.

5.3 Troubleshooting

About error codes, please, refer to Annex VII of the Technical Appendix.

NO WATER AT TAP	<ul style="list-style-type: none"> • Ensure all valves on appliance are open and it is turned ON. • Check the control panel display. Please refer to “Error Codes” to determine solution to this problem. • Check the outlet pump, press reset on the pump controller (refer to <i>Lowara Genyo Pump Controller Manual</i>). • If the tank has run dry, you may need to loosen the bleed screw on the outlet pump to vent air and resolve an air locked pump. • If the problem persists contact your Xylem service agent.
LOW WATER FLOW AT TAP	<ul style="list-style-type: none"> • Ensure all valves on appliance are open. • Check that the outlet pump is running normally and is not air locked. • If water flow has gradually deteriorated, check that the outlet filter has not blinded.
NO POWER IN UNIT	<ul style="list-style-type: none"> • Ensure appliance is turned ON.. • Ensure there is power to the supply cable. • If the problem cannot be found contact your Xylem service agent.
SCREEN DISPLAYS FILTER DUE	<ul style="list-style-type: none"> • The filter installed in the appliance will soon require replacement. You may need to order a new filter from your distributor. To see the date by which the filter must be replaced, check the value for “Filter due date” in the “System Info” menu.
SCREEN DISPLAYS FILTER DUE, SYSTEM DISABLE XX HRS	<ul style="list-style-type: none"> • The filter installed in the appliance is about to expire. If a new filter is not installed within the required time then the system will shut down.
SCREEN DISPLAYS LOW FLOW	<ul style="list-style-type: none"> • The appliance has detected that there is a low volume of water flowing into the system. Follow these steps to resolve this issue. <ul style="list-style-type: none"> - Check that inlet and outlet valves are fully open. - Check for any blockage of the source water supply. - Check that the inlet pump is operating correctly. - Check the inlet filter and replace if necessary
SCREEN DISPLAYS LAMP DUE	<ul style="list-style-type: none"> • The UV-C Lamp installed in the appliance will soon require replacement. You may need to order a new lamp from your distributor to get an indication of when the lamp must be replaced, check the value for “Lamp hours remaining” in the “System Info” menu.
SCREEN DISPLAYS LAMP DUE SYSTEM DISABLE XXHRS	<ul style="list-style-type: none"> • The UV Lamp installed in the appliance is about to expire. You may need to order a new lamp from your distributor if a new lamp is not installed within the required time then the system will shut down.
SCREEN DISPLAYS HIGH FLOW	<ul style="list-style-type: none"> • There is a problem with the inlet flow rate. Please contact your Xylem service agent to arrange a repair.
WATER LEAKING FROM FILTER	<ul style="list-style-type: none"> • Check O-ring held in filter housing is clean and properly seated. See 5.1.1.
WATER LEAKS FROM ELSEWHERE IN THE SYSTEM	<ul style="list-style-type: none"> • Turn off system and contact your Xylem service agent

Technical Appendix

Fig. 1 Handling

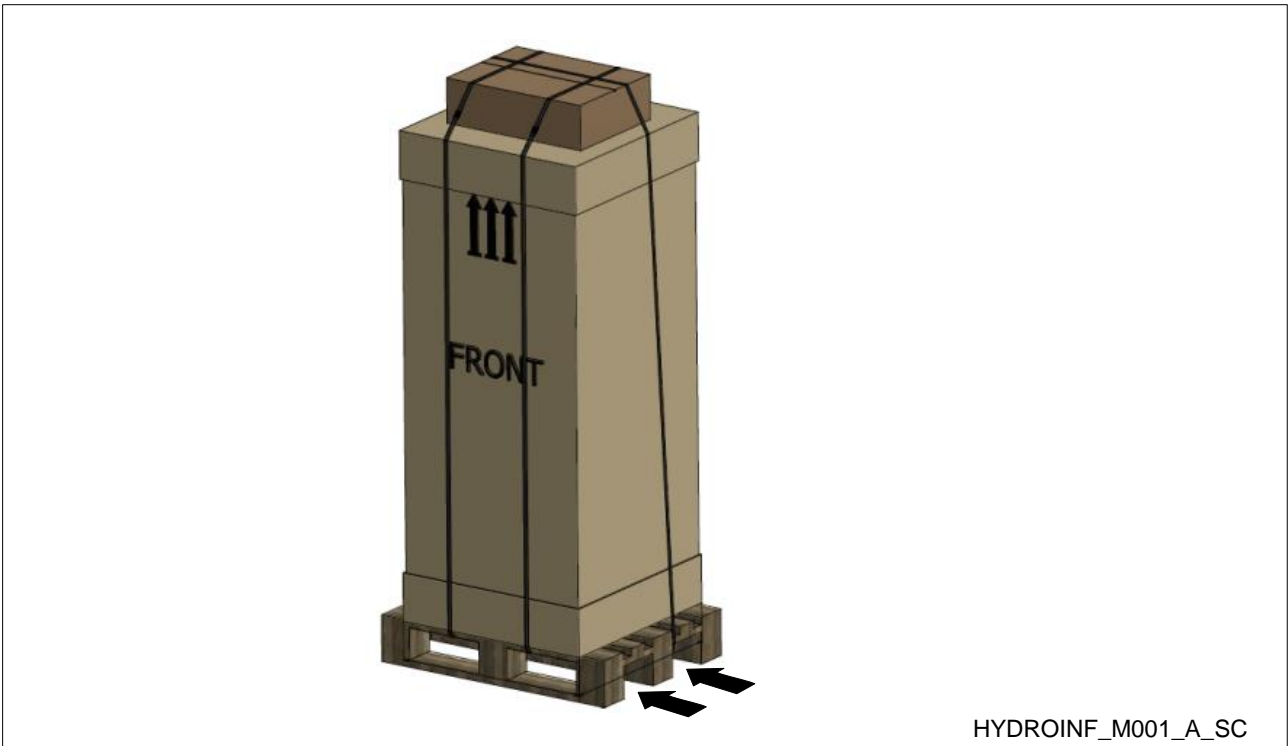

HYDROINF_M001_A_SC

Fig. 2 Data plate

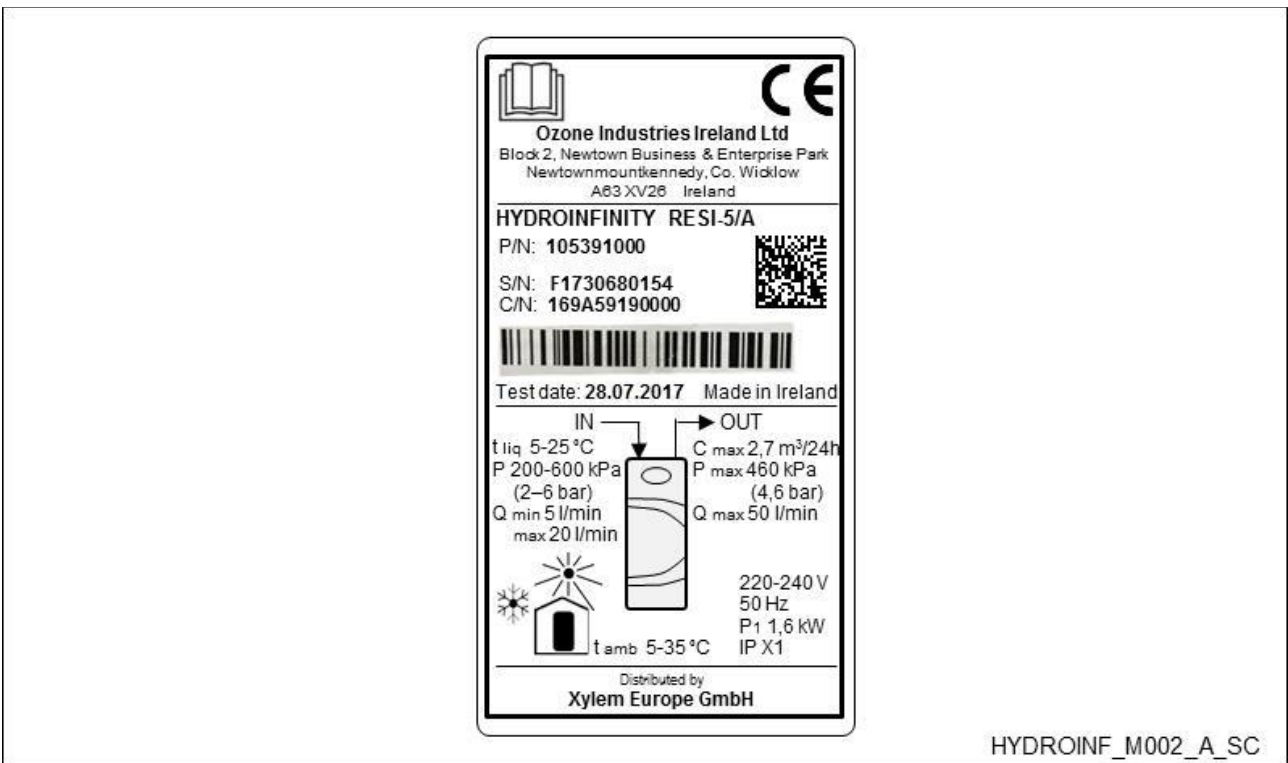

HYDROINF_M002_A_SC

Fig. 3 Composition

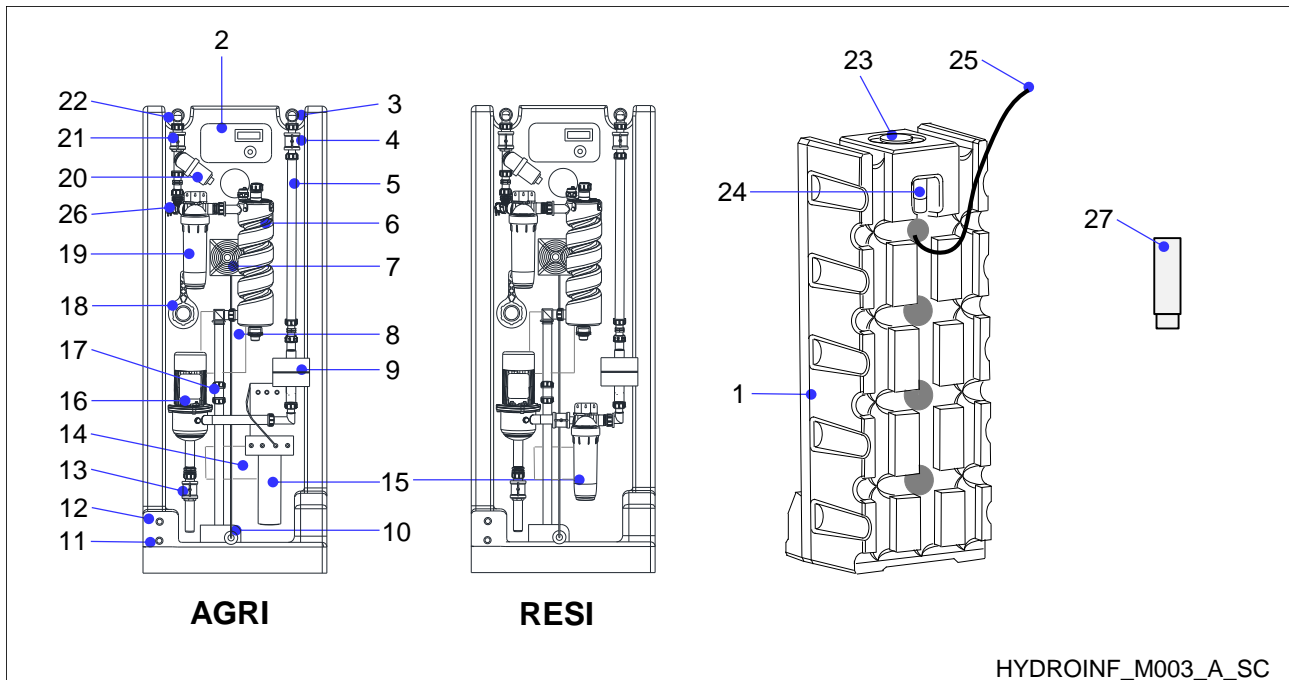

HYDROINF_M003_A_SC

1	Tank	stores the treated water ready for use.
2	Control Panel	controls operation of system & treatment.
3	Outlet 1" BSP	treated water is pumped out of the storage tank.
4	Outlet Isolation Valve	stops flow of treated water from the appliance to outlet.
5	Outlet Riser Pipe	delivery of treated water from the appliance to Outlet 1" BSP.
6	UV Reactor	germicidal sanitiser.
7	Ozone (O₃) Generator	generates ozone by way of corona discharge.
8	Air Compressor	pumps dried air through the ozone generator and into the storage tank.
9	Outlet Pump Controller	control for outlet pump to supply treated water on demand.
10	Diffuser	bubbles ozone into the stored water in the tank.
11	ORP (Redox) probe	measures ozone in water.
12	Level Sensor	measures water level in tank.
13	Pump Isolation Valve	for maintenance purposes only (to allow service/ repair of the pump).
14	Air Dryer	removes humidity from the air for ozone generation.
15	Second Air Dryer (AGRI)	removes humidity from the air for ozone generation while the first dryer is cooling.
	Outlet Filter (RESI)	converts ozone to oxygen (manganese dioxide MnO ₂)
16	Outlet Pump	supplies treated water from the appliance to outlet.
17	Flow Meter	monitors incoming flow, alarms for blocked inlet filter, flow too low or unexpected water flow.
18	Filter Wrench	for maintenance purposes (for use when changing filters).
19	Inlet Filter	filters fine particles from the source water (PA wounded wire 5 µm).
20	Solid Particle Filter	filters larger particles from the source water.
21	Inlet Isolation Valve	stops inlet flow of source water to the appliance.
22	Inlet 1" BSP	connection to supply of source water
23	Lid	seals the tank.
24	Overflow Vent Connection (DN 50-PVC)	overflow for the system, tank breather, and vents any excess ozone to atmosphere.
25	Power Supply Cable	supplies power to the system (provided without plug).
26	Solenoid valve	controlled by control panel, it consents to incoming water to flow.
27	Catalytic filter (RESI)	to use when and where a correct venting (24) is impossible to do, supplied on demand .

Fig. 4 Dimensions

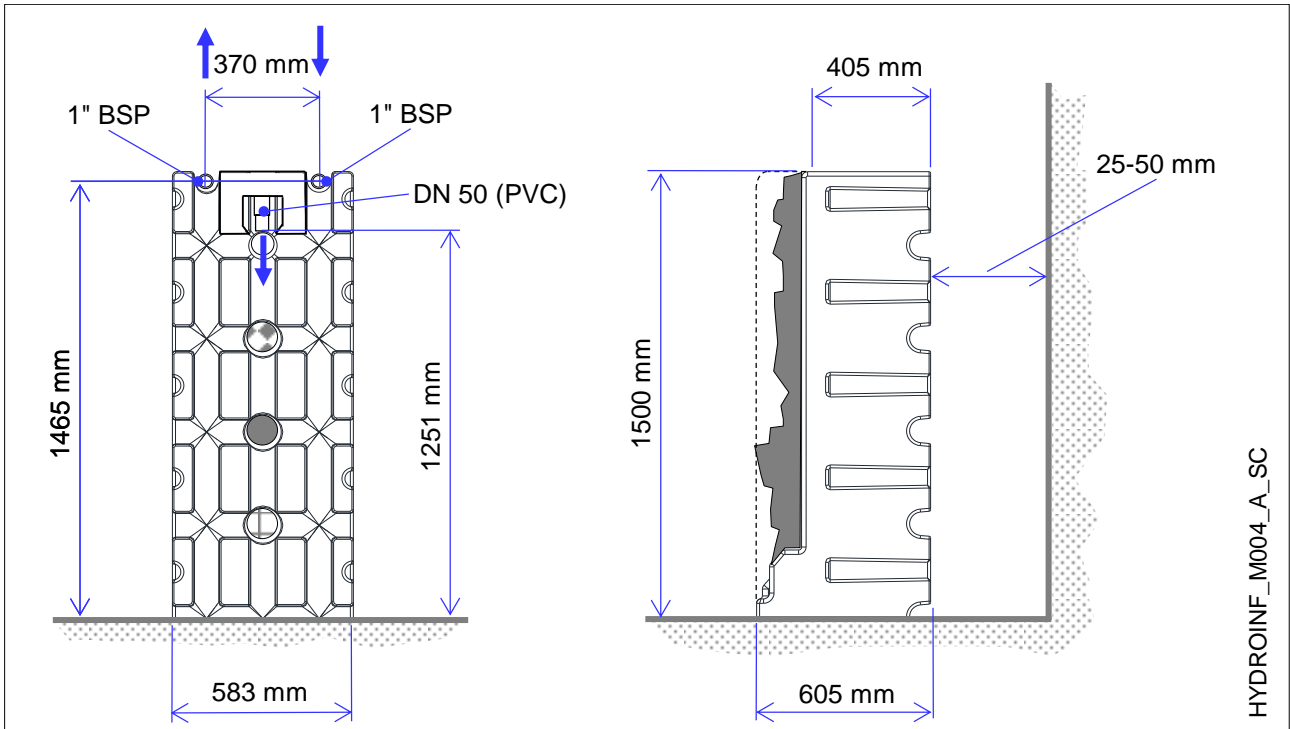
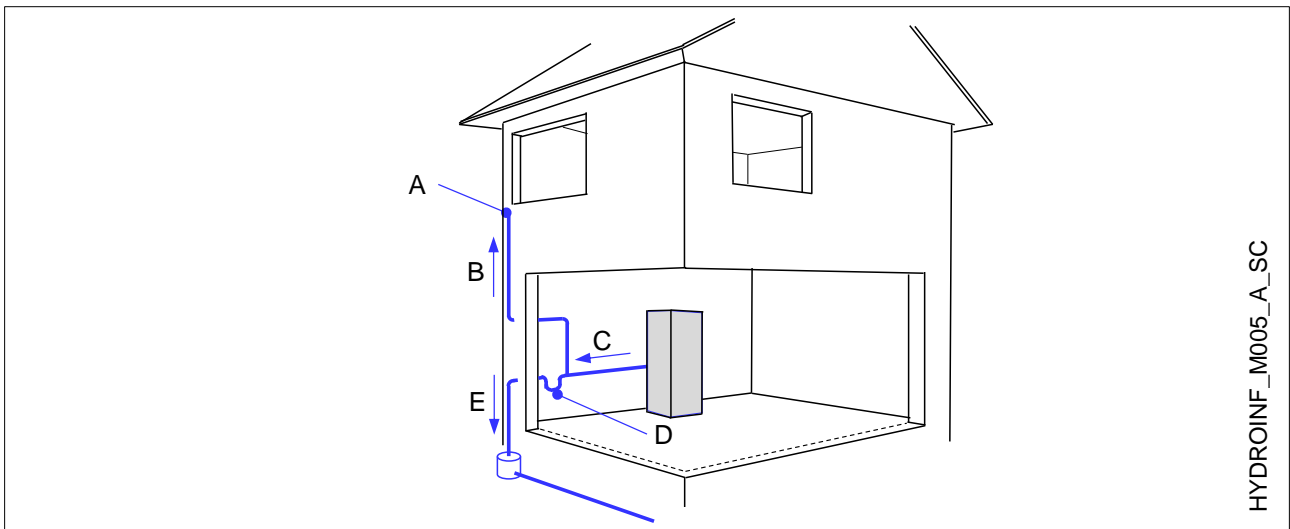

Fig. 5 Suggested Set Ups for Overflow System and Venting

NOTE Each installation is on a case by case basis and the below are examples only. Professional advice should be sought for every proposed installation.

The ozonated water is fed into a closed drain pipe



A	Ozone vents at a minimum of 500 mm above, below or sideways from an opening window
B	Ozone
C	Water+Ozone
D	U-Bend
E	Ozonated water

- The excess water goes directly into a free flowing closed draining pipe.
- A U-bend on the overflow pipe will separate the ozonated water from ozone gas. The ozone gas will be vented to a high point outside the building.

Fig. 6

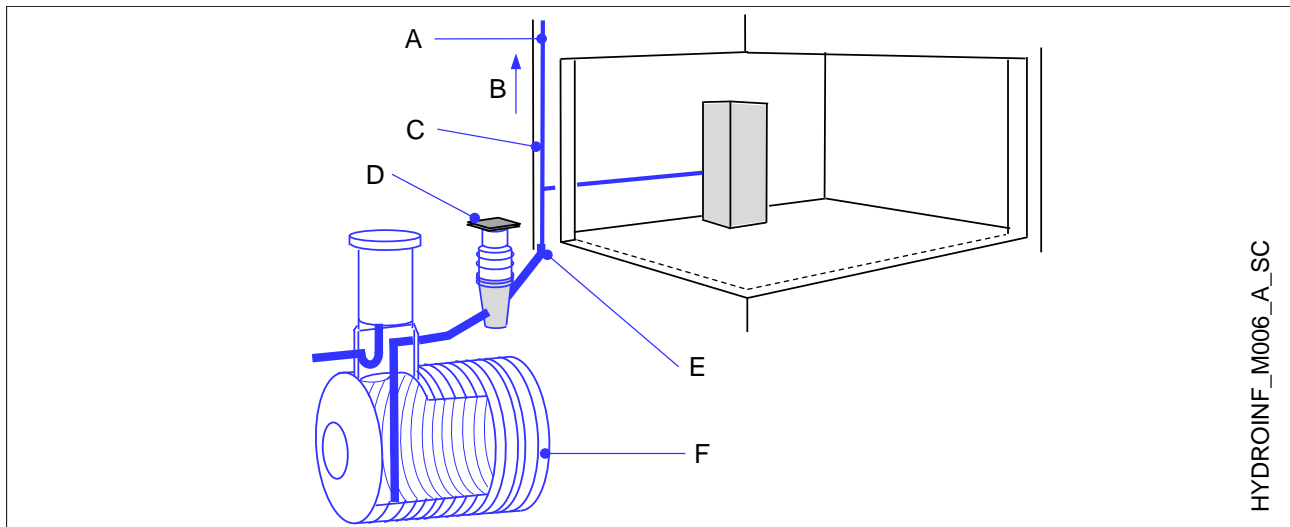
The ozonated water is fed back into the rainwater tank

HYDROINF_M006_A_SC

A	Ozone vents at the highest point
B	Ozone
C	Existing external down pipe from gutter
D	Flush diverter
E	Make sure this connection is sealed
F	Rainwater tank

- The excess water goes directly into the gutter that feeds the rainwater tank.
- The ozone will vent naturally at the top of the gutter and the ozonated water will be drained into the flush diverter and then into the rainwater tank.

General Notes

(If the requirements below cannot be met, the installer must NOT INSTALL the appliance)

- In normal operation, the appliance will produce ozone offgas that will be vented through the overflow pipe along with the surplus water.
- The overflow pipe is DN 50 PVC and needs to be prepared with abrasive paper before connected to the drain system.
- Ozone will attack NBR rubber. Only use glued or welded joints or EPDM, silicone rubbers.
- The drain system **MUST BE A CLOSED FREE FLOWING SYSTEM**, no other pipes should be connected to this system.
- Make sure to have a free flowing system with at least 2.5% drop.
- The water and the ozone gas must be separated; we recommend using a U-bend.
- The water which will also contain ozone will be drained separately. We recommend that it will be drained back into the water harvesting tank (if available). If not possible the water needs to be directed through a closed system on a drain outside.
- The ozone in the water can react with certain materials so be sure to use materials non-reactive to ozone on your drain pipes (PE or PVC piping).
- The ozone must be vented outside at a point as high as possible where the people and animals won't get in contact with the gas.
- Make sure the Ozone cannot re-enter the house or affect the residents.
- In the unlikely event that ozone may leak from the machine, the appliance must be installed in a well-vented room with venting on an external wall to an appropriate high point.

Please, refer to point 1.2.3 and Annex I of the Technical Appendix about the risk of ozone exposure.

HYDROINFINITY RESI

Only when and where a correct venting is impossible to do, a catalytic filter can be used to reduce the ozone offgas. It is supplied on demand and subject to periodically maintenance.

Fig. 7 Valves and switches

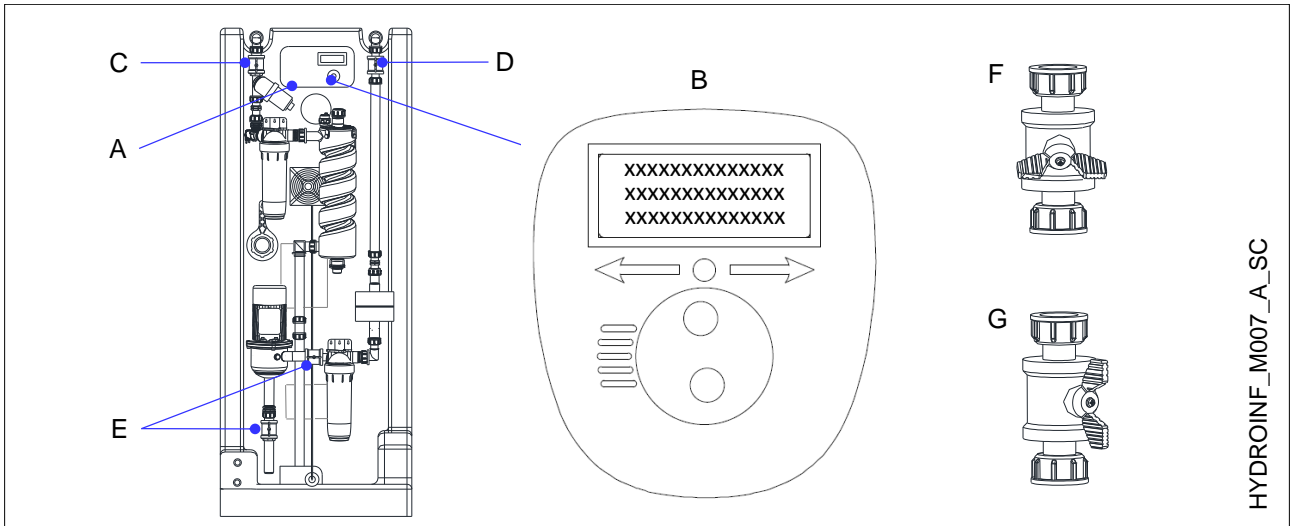

HYDROINF_M007_A_SC

A	The power button is located HERE. Underneath the Control Panel.
B	The appliance is controlled from the Control Panel. Turn the WHEEL left or right to highlight your choice and press it to select.
C	Inlet Valve.
D	Outlet Valve.
E	Pump Isolation Valve.
F	A CLOSED valve looks like this.
G	An OPENED valve looks like this.

Fig. 8 Accessories

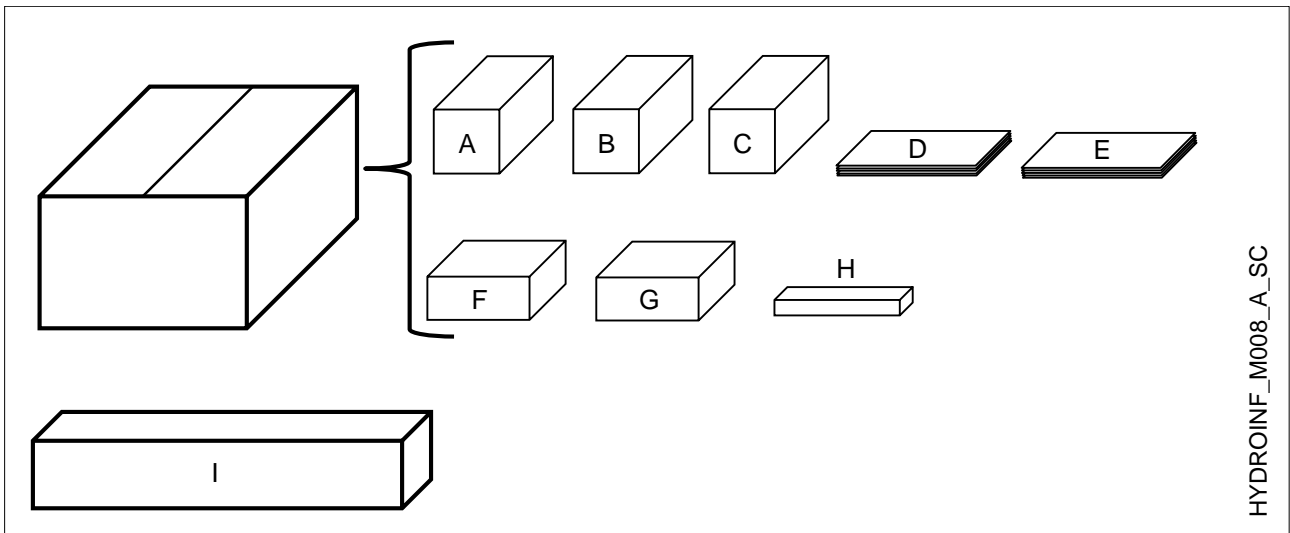

HYDROINF_M008_A_SC

A	Inlet Filter *
B	Outlet Filter (RESI) *
C	Solid Particle Filter *
D	Instructions of Outlet Pump Controller (Lowara Genyo series)
E	Instructions of Outlet Pump (Lowara e-HM series)
F	Mobile WI-FI™ router with package and instructions
G	Adaptors for power charger of Mobile WI-FI™ router
H	ORP probe with package and instructions
I	Catalytic Filter (on demand)

* housing and cartridge

Fig. 9 ORP Probe

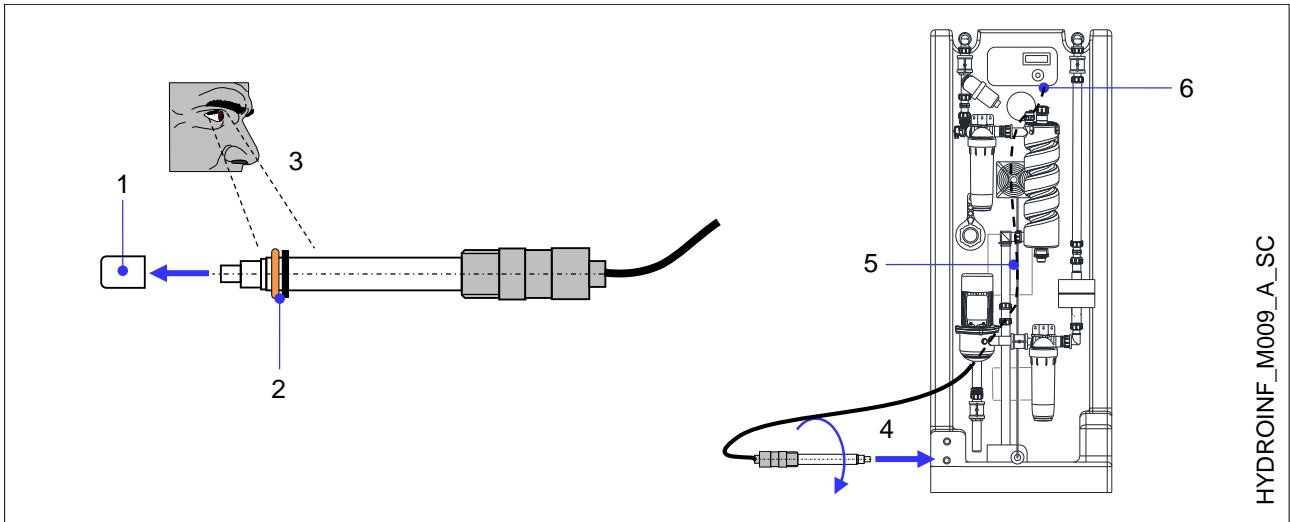

Fig. 10 Filters installation

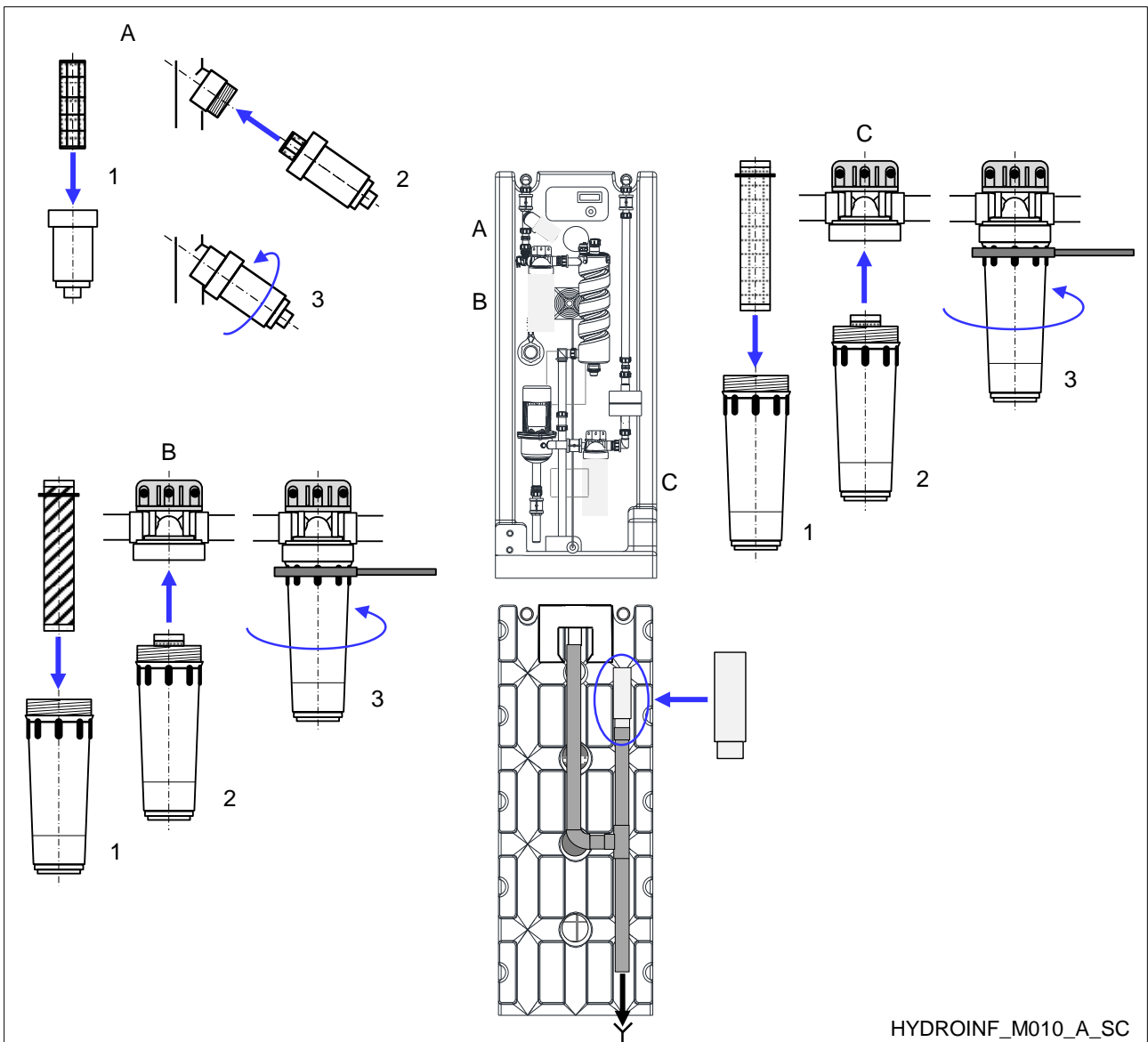
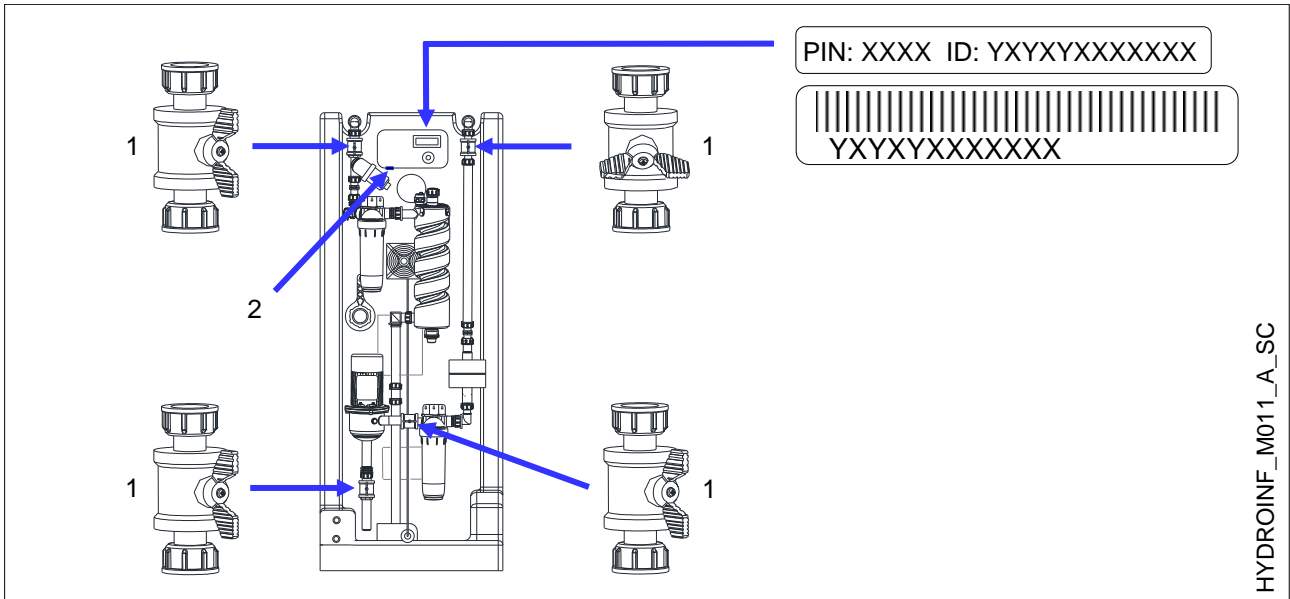

Fig. 11 Start-up



HYDROINF_M011_A_SC

Fig. 12 Menu structure

THIS IS THE STRUCTURE OF MENU ACCESSIBLE FROM THE CONTROL PANEL

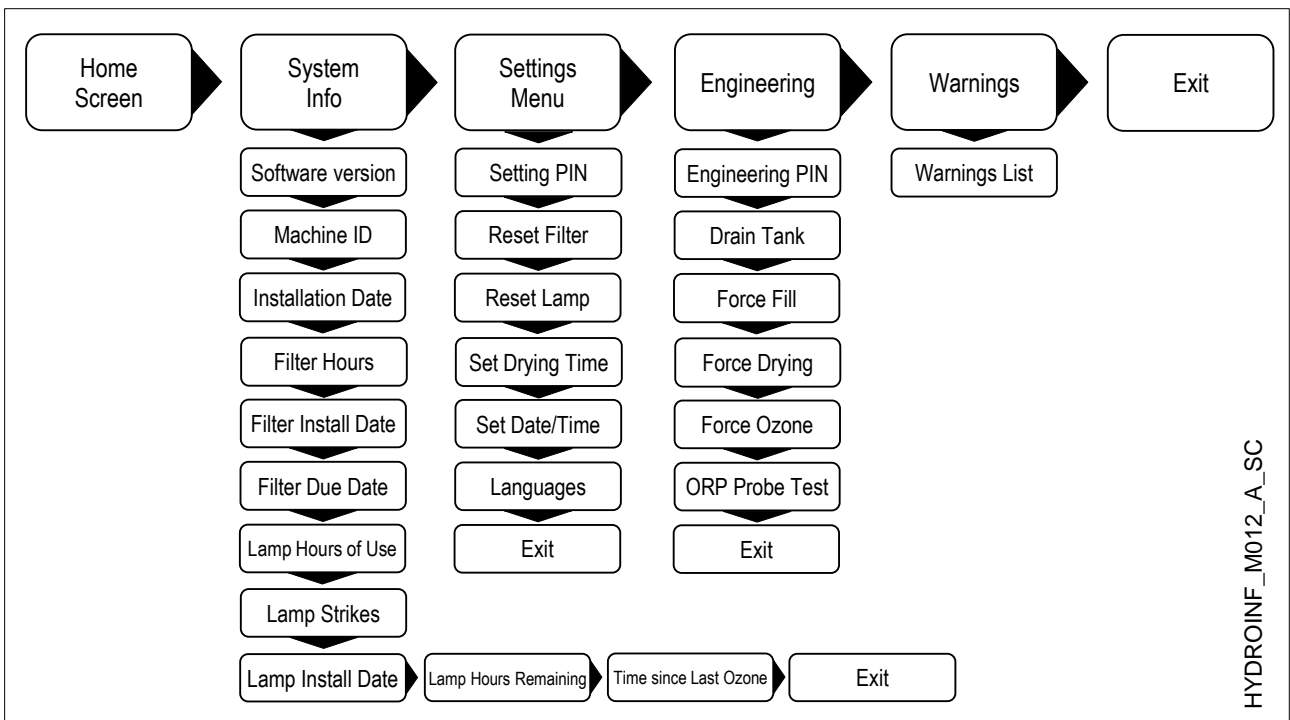

HYDROINF_M012_A_SC

Fig. 13 Display

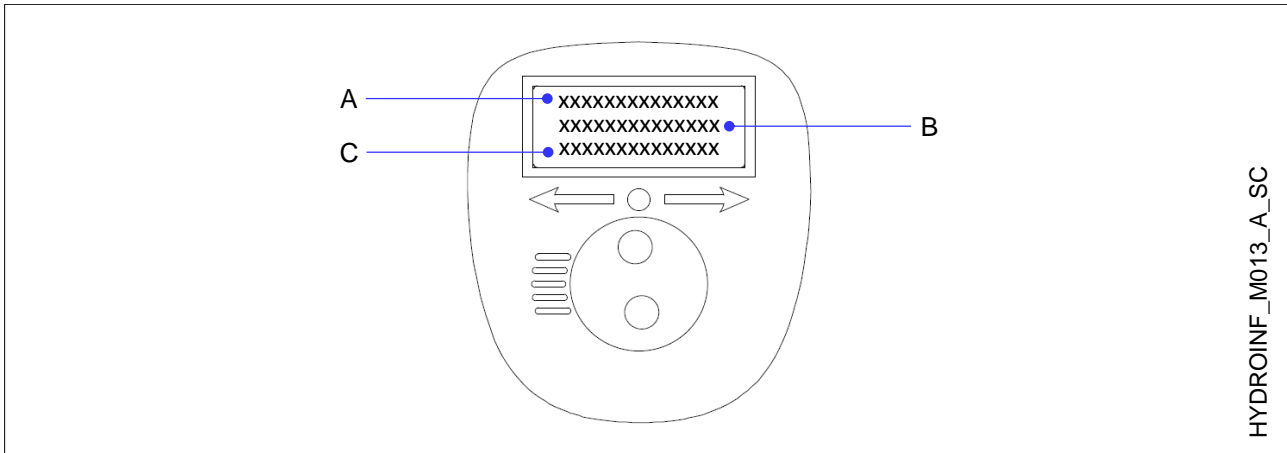

A	Line 1 displays the software version of the machine and the time.
B	Line 2 shows the reading from the machine ORP probe, the level of water in the tank and the rate of flow of incoming water.
C	Line 3 shows the machine status, the temperature of the water and the reading from the Ozone probe.

Status Meaning

Inactive	Appliance is preparing to be active.
Active	Appliance is monitoring water quality, no treatment taking place.
Warm-up	System is preparing to treat incoming water. UV lamp is warming up.
Fill	Inlet pump and lamp are on, water treatment in progress.
Cool-down	System has finished treating incoming water. Inlet pump is off and lamp is cooling down.
Ozone On	Water is being ozonated.
Drying	The dryer is operating; no water treatment may take place. Water is available.
Cooling	The dryer is cooling; no water treatment may take place. Water is available.

Fig. 14 Draining/Filling

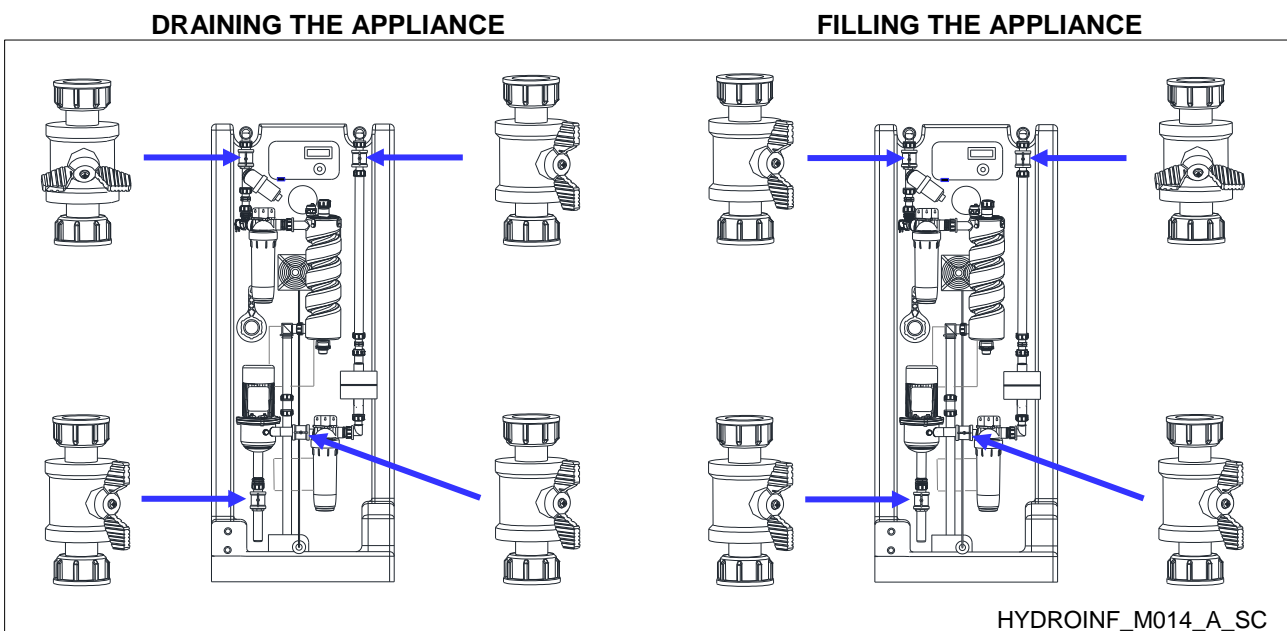

1. Close the inlet valve and make sure the outlet valve is opened
2. Turn on a connected tap to empty the tank

1. Make sure the inlet valve is opened and close the outlet valve
2. Turn the appliance ON and it will start filling
3. Open the outlet valve after the machine is filled

Fig. 15 Solid particle filter

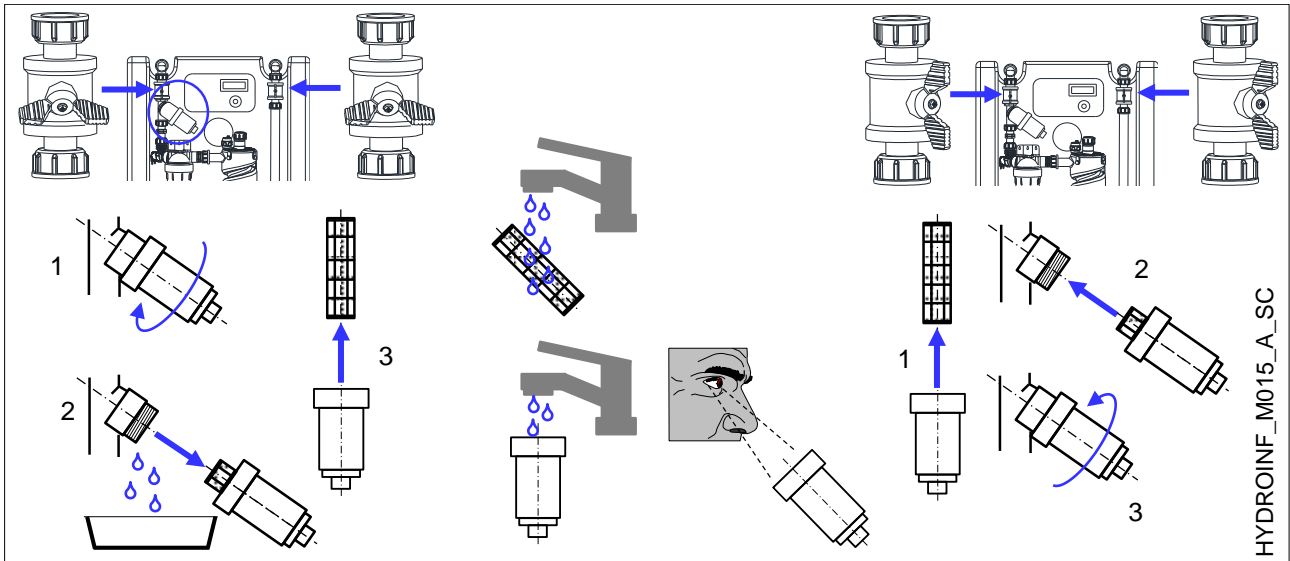

Fig. 16 Inlet filter

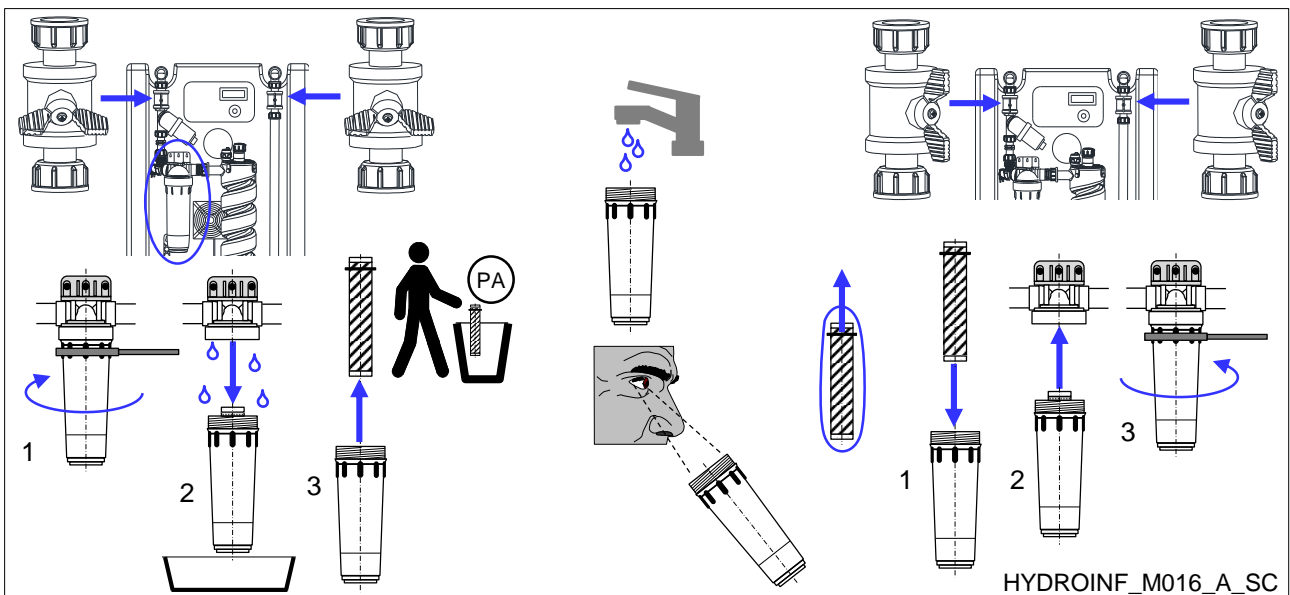

Fig. 17 Outlet filter

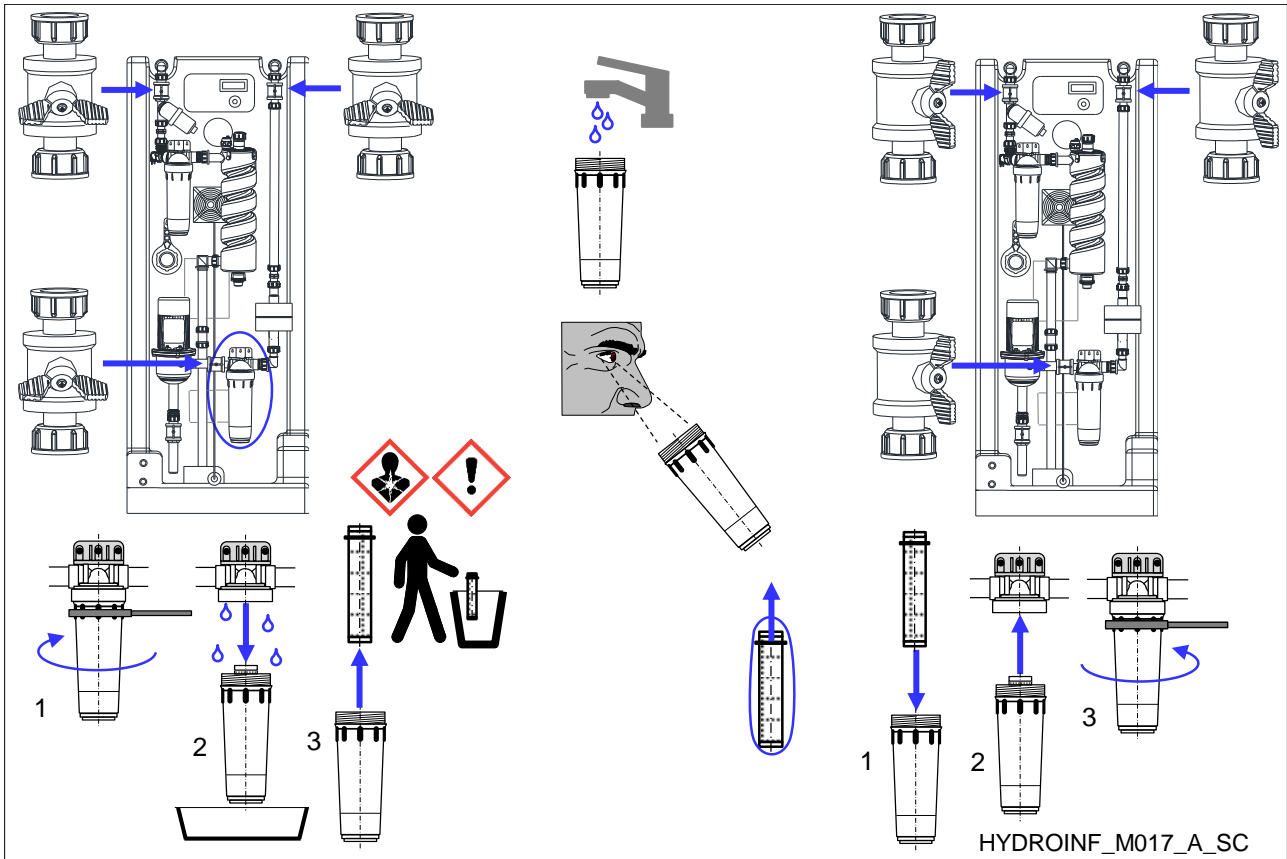

Fig. 18 Catalytic filter

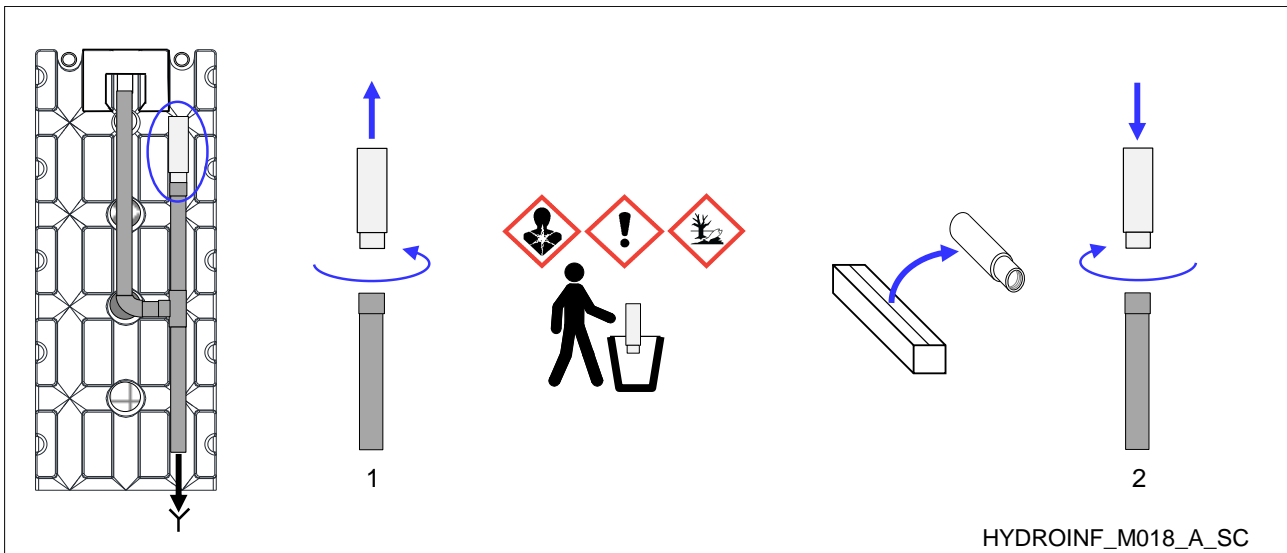
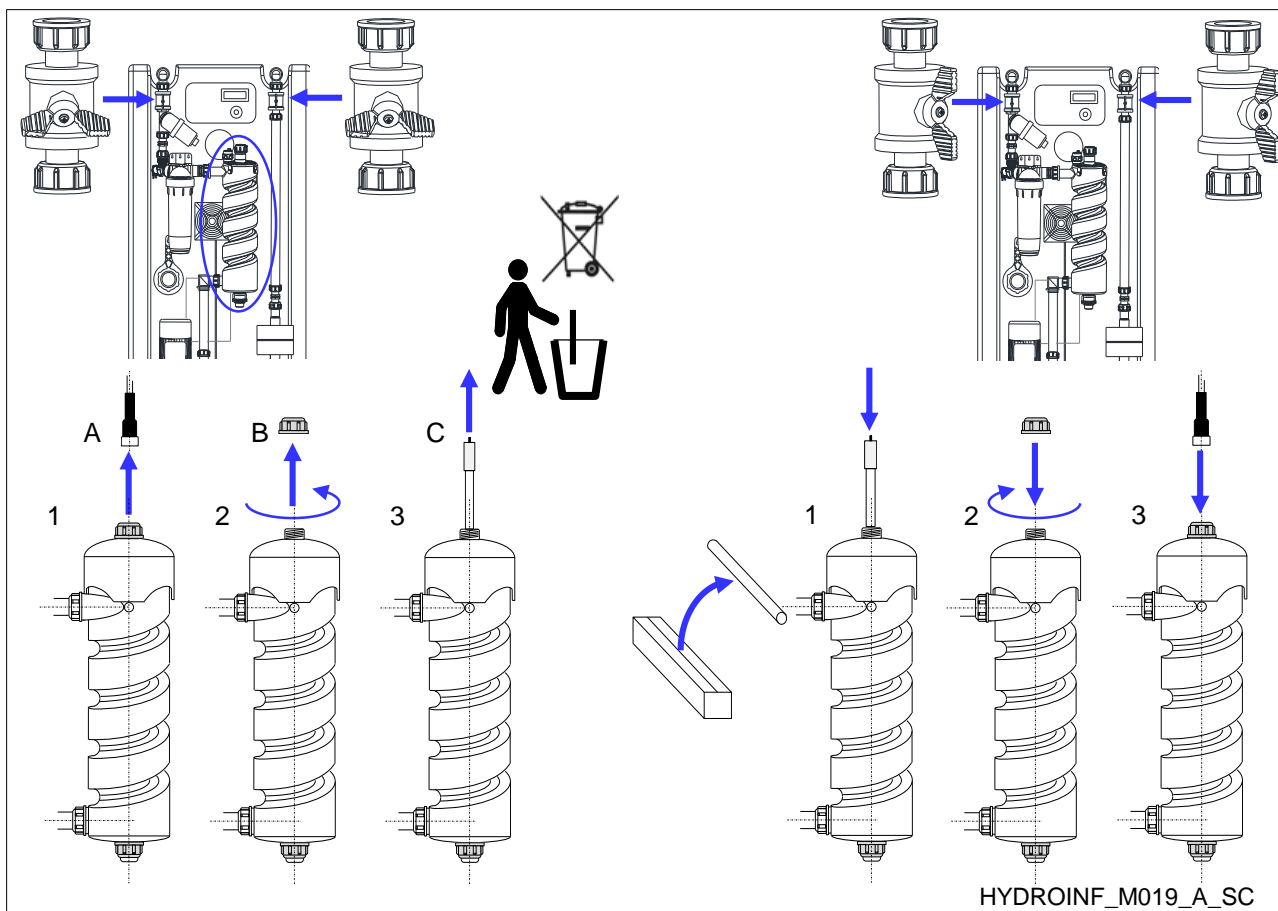

Fig. 19 UV lamp



A	Ceramic plug
B	Plastic lock nut
C	UV Lamp

Annex I

OZONE (O₃)

EC no. 233-069-2

CAS no. 10028-15-6

Water disinfectant oxidising agent generated on-site for the disinfection and control of the broad spectrum of microorganisms.

**DANGER**

- H270 May cause or intensify fire; oxidizer
- H373 May cause damage to organs through prolonged or repeated exposure
- H319 Causes serious eye irritation
- H341 Suspected of causing genetic defects
- H315 Causes skin irritation
- H335 May cause respiratory irritation
- H330 Fatal if inhaled
- H400 Very toxic to aquatic life

If medical advice is needed, have product container or label at hand. Keep out of reach of children. Store in cool, dry well ventilated place. Keep & Store away from clothing/combustible materials. Keep reduction values free from grease and oil. In case of fire, stop leak if safe to do so. Heating in the presence of certain catalysts such as Hydrogen, Iron, Copper and Chromium may cause explosion.

Appearance and Odour

Ozone is colourless at all concentrations. It has a very pungent characteristic odour. Ozone odour is generally detectable at concentration of 0.02-0.05 ppm.

Ingredients

Ozone in air 0.6% w/w

Directions for use

Ozone must be contained within ozone-resistant tubing and pipes from the generation point to the application point. Ozone must be stored to avoid contact with any organic and inorganic oxidizable materials (such as wood, paper and oil); alkenes, diethyl ether, nitrogen compounds, oxidising agents, organics and aromatics and strong acids since violent reactions occur. Store in a cool, dry, well-ventilated place away from strong bases and organic materials. Ozone off gas destruct, prior to release to atmosphere.

Ozone Industries Ireland Ltd
Block 2, Newtown Business & Enterprise Park
Newtownmountkennedy, Co. Wicklow
A63 XV26
Ireland
Tel no: 00353 1 281 1646
e-mail: info@rainsafewater.com

Annex II

MANGANESE DIOXIDE (MnO₂)

EC no. 215-202-6

CAS no. 1313-13-9



Catalytic substance for ozone removal from water

WARNING

- H302 Harmful if swallowed
- H332 Harmful if inhaled
- H373 May cause damage to organs through prolonged or repeated exposure

Appearance and Odour

Brownish-black granular material, odourless.

Ingredients

Manganese dioxide 78-82%

Directions for use

Manganese dioxide should not be heated or rubbed with organic matter or other easily oxidizable substances, e.g. sulphur, sulphides, phosphides, hypophosphides, etc. Material is flammable by chemical reaction. Incompatible with hydrogen peroxide and sodium peroxide. Keep away from heat and flammable materials.

**MANGANESE DIOXIDE (MnO₂) +
COPPER OXIDE (CuO)**

EC no. 215-202-6

CAS no. 1313-13-9

EC no.: 215-706-6

CAS no. 1344-70-3



Catalytic substance for ozone removal from water

WARNING

- H302 Harmful if swallowed
- H332 Harmful if inhaled
- H373 May cause damage to organs through prolonged or repeated exposure
- H400 Very toxic to aquatic life
- H410 Very toxic to aquatic life with long lasting effects

Appearance and Odour

Granular material.

Ingredients

Manganese dioxide 40-70%

Copper oxide 15-40%

Directions for use

When handling this substance: do not breathe the dust, fume, gas, mist, vapours or spray; use only outdoors or in a well-ventilated area; do not eat, drink or smoke when using this product; avoid release to the environment; wash parts of the body (as specified by manufacturer/supplier) in contact with substance thoroughly after handling.

Ozone Industries Ireland Ltd
Block 2, Newtown Business & Enterprise Park
Newtownmountkennedy, Co. Wicklow
A63 XV26
Ireland
Tel no: 00353 1 281 1646
e-mail: info@rainsafewater.com

**Annex III
WEEE**



the requirement not to dispose of WEEE as unsorted municipal waste and to collect such WEEE separately;

The crossed bin symbol on the equipment or on its packaging indicates that the product at the end of its useful life must be collected separately from other waste.

The user must therefore confer the equipment at the end of its life to the appropriate municipal collection centers for electrotechnical and electronic waste.

Appropriate separate collection for the subsequent start-up of the disused equipment for recycling, treatment and environmentally compatible disposal helps to avoid possible negative effects on the environment and on health and favors the re-use and / or recycling of the materials it is composed of the equipment

**Annex IV
Technical Data**

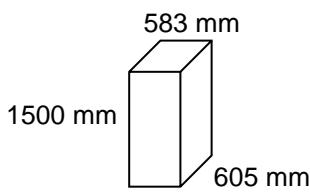
Operating environment	<ul style="list-style-type: none"> ▪ Indoor use only. ▪ Protected by sun rays and freeze. ▪ Non-aggressive and non-explosive atmosphere.
Temperature	From 5°C (+41°F) to +35°C (95°F).
Relative air humidity	≤ 75% (non-condensing).
Altitude	Between 170 m (550 ft) below sea level and 4887 m (15000 ft) above sea level.
Liquid temperature	From 5°C (+41°F) to +25°C (77°F).
Operating pressures	Inlet: from 200 kPa (2 bar) to 600 kPa (6 bar) Outlet: ≤ 460 kPa (4,6 bar)
Operating flows	Inlet: from 5 l/min to 20 l/min Outlet: ≤ 50 l/min
Daily treatment capacity	≤ 2,7 m ³
Electrical supply	1 x 220-240 V 50 Hz
Rated power	1,6 kW
Power connection	2,5-meter long H05VV-F 3G1 power cable, without plug
Protection degree	IPX1
Water connections	Inlet: 1" BSP female Outlet: 1" BSP female Overflow: DN 50 All the pipes and fittings that come in contact with treated water must be ozone resistant.
Dimensions (without package)	
Weights (without package)	Empty: 52 Kg Full of water: 300 Kg
Noise level	LpA < 70 (± 2) dB Sound pressure level measured in free field at a distance of one metre from the appliance.
Source Water (*)	May be understood as rain, well, surface water or treated municipal water which complies with the Inbound Water Parametric Requirements (Annex V). It does not include transitional waters (eg. estuarine, brackish or tidal waters) or coastal water or any other form of water other than water defined as source water.
Backup Water (*)	May be understood as water that supplements the source water during periods of low water supply.
Wi-Fi® router	1 x 220-240 V 50 Hz 3,5 W (battery Li 1500 mAh)

(*) Where the source and/or backup water is likely to come from municipal water, before of all verify if local drinking water installation regulations and/or guidelines allows to connect a water treatemnt device to the mains and check how to do that.

Ozone Industries Ireland Ltd make no warranty or representation as to the quality of or compliance of the municipal supply or any other backup water supply with national or local regulatory requirements guidelines or standards .

Backup water should be supplied to the applaince in accordance with the requirements of EN1717:2001(Backflow Prevention Device) where appropriate and/or the equivalent standard for the prevailing local drinking water installation regulations and/or guidelines.

Professional advice should be sought in this regard to ensure compliance.

NOTICE

- Where the source and/or backup water contains chlorine (municipal), a carbon filter must be installed before the water is supplied into the appliance.
-

**Annex V
Inbound Water Parametric Requirements**

	Parameters	Unit	Value		Detected value
•	pH	-	from 6,5 to 8,5		
•	UV percent transmittance (UVT)	-	≥ 80%		
•	Turbidity	NTU	≤ 4		
•	Total Organic Carbon (TOC)	mg/l	≤ 4		
•	Total Suspended Solids (TSS)	mg/l	≤ 1		
•	Hardness	mg/l CaCO ₃	≤ 120		
•		°Fr	≤ 12		
•	Iron (Fe)	µg/l	< 200		
•	Copper (Cu)	mg/l	< 2		
•	Chlorine (Cl)	mg/l	zero		
•	Bromides (Br)	µg/l	< 5	1)	
•	Total Coliforms	number/100 ml	-		
•	Escherichia coli (E. coli)	number/100 ml	-		
•	Clostridium perfringens	number/100 ml	-	2)	
•	Colour	-	-	2)	
•	Total Viable Count (TVC) at 37 °C	number/ml	-		
•	Total Viable Count (TVC) at 22 °C	number/ml	-		

1) recommended for HYDROINFINITY RESI.

2) recommended for HYDROINFINITY AGRI.

General Notes

(If the requirements below cannot be met, the installer must NOT INSTALL the appliance)

Rainwater harvesting requirements

It is recommended that any installed rainwater harvesting system comply with BS 8515:2009 (UK), ARCSA/ASPE/ANSI 63-2013 Rainwater Catchment Systems (USA) or equivalent standard.

Key Requirements (other requirements may be needed)

- The surface from which the water is collected must be clean and from a non-reactive material.
- The gutters must be clean, in good condition, protected with leaf guards.
- A first flush diverter is recommended.
- Floating suction is mandatory.
- Calmed inlet is mandatory.
- The installer must check the placement, type and capacity of the water tank and determine that it can meet the appliance requirements.
- The installer must check the lift pump is fit for purpose.

Mains water requirements:

- If mains water is used a filter that removes chlorine must be installed before the water enters the appliance.
- The mains water must comply with the source water parameters

Annex VI ORP probe

pH/REF/ORP ELECTRODES

OPERATING INSTRUCTIONS

PREPARATION FOR USE.

All sensors are shipped with the measuring end covered with a soaker teat. Remove the soaker teat from the electrode and keep in a safe place for future long term storage.

After rinsing the measuring end with deionised water, the electrode is ready for use.

During shipment it is possible for air bubbles to move into the glass bulb. To remove the air, shake down the electrode in the same manner as a clinical thermometer until the glass bulb is filled with solution.

ELECTRODE STORAGE

pH glass electrodes should be stored in a 4.0 pH Buffer for both overnight and long term storage

Reference and Glass/Plastic combination electrodes should be stored in a 3.0 Molar KCl solution (pH adjusted to 4.0) if they are single junction types. Use a 3.0 Molar solution of the appropriate salt if double junction types.

ELECTRODE CARE & CLEANING

Slow response and non-reproducible measurements are signs that the electrodes have become coated or clogged.

If the glass becomes coated or clogged the time taken to make a measurement will increase (normally 95% of final reading should be achieved in less than 10 seconds).

Rinsing with methyl alcohol should remove the coating and restore the speed of response.

O.R.P. electrodes may need additional cleaning from time to time with crocus paper.

If the methyl alcohol rinse does not restore the response, soak in 0.1 Molar HCl for five minutes. Remove and rinse with water and place in 0.1 Molar NaOH for five minutes, Remove, rinse again, and soak in 4.0 pH buffer for 10 minutes before use.

If a pH electrode is continuously used above 60°C the outer layer of the pH glass loses its sensitivity. This can be restored as follows:

1. Prepare a 10% solution of ammonium bifluoride.*
2. Immerse electrode for 10-20 seconds.
3. Rinse in water.
4. Immerse in 5 Molar HCl for 5 minutes to remove any excess bifluoride.
5. Rinse again in water.
6. Soak in 4 pH buffer for 1 hour before use.

*** THIS IS A HAZARDOUS CHEMICAL AND SHOULD ONLY BE HANDLED BY A QUALIFIED CHEMIST FAMILIAR WITH FLUORIDE COMPOUNDS.**

NOTE: All pH electrodes respond best after being stored in slightly acidic solutions such as 4.0 pH buffer.

Reference electrodes use a liquid junction for electrical contact to the solution being measured. If the junction becomes clogged or coated, the reference becomes erratic. Cleaning with **METHYL ALCOHOL** or **0.1 Molar HCl** periodically will enhance the electrodes performance.

Storage should be in slightly acidic 3.0 Molar KCl solution.

COMBINATION pH ELECTRODES, being a combination of REFERENCE AND pH GLASS ELECTRODES, should be cleaned as listed above and stored in slightly acidic 3.0 Molar KCl solution.

FILLING SOLUTIONS

NOTE: Certain combination Electrodes are filled with KCl gel. These do not require filling and have no filling hole on the side of the electrode.

Reference Electrodes — Saturated KCl

Combination pH/ORP Electrodes — 3.0 Molar KCl saturated with AgCl

To fill electrode, slide down plastic ring to reveal hole in side. Using a small syringe, fill the outer part of the electrode (via the hole) with the filling solution detailed above, until the filling solution is just level with the hole. Slide the plastic ring back to cover the hole.

**Annex VII
ERROR CODES**

Message	Meaning
Error Lamp Fail	UV-C lamp has failed. The system cannot treat any more water until a new lamp has been installed and the Lamp timer has been reset. See 5.1.1.5 on how to resolve this issue.
Error No Flow	The appliance has detected that water is not flowing at the inlet. The treatment system will remain shut down until such time as this error is resolved.
Error High Flow	The appliance has detected water is flowing too quickly at the inlet to allow adequate UV treatment to take place. Water inlet is disabled and water will be unavailable at the outlet until such time as this error is resolved. Contact your Xylem service agent.
Error Fill timeout	The appliance has been constantly treating water for 30 minutes without registering as being full. As a precaution to guard against leaks it has shut down. If you are satisfied that the system has been operating correctly then this error may be cleared by selecting “clear error”.
Error Unexpected Flow	The appliance has detected a flow of water while the UV system is not active. The system will shut down to prevent delivery of water until such time as the problem has been resolved. Contact your Xylem service agent.
Error Ozone Fail	The appliance has not detected an improvement in water quality after the Ozone generator has been switched on for 30 minutes. Possible causes include: Poor source water quality; Air dryer exhausted; Ozone system failure; ORP probe disconnected; ORP probe faulty. If the error persists after manually triggering a drying cycle and checking the ORP probe connection, contact your Xylem service agent.
Error Level Detection	The appliance has detected a problem with its internal water level sensors. The system cannot treat any more water until this issue is resolved. Please contact your Xylem service agent.
Error Filter expired	Filter was not replaced within the recommended time frame. The system cannot treat any more water until the new filter is installed and the filter timer has been reset. See 5.1.1 for instructions on how to resolve this issue. If this error arises after filter have been changed this indicates that the timers were not reset. Follow the procedure “New filter” under “Settings Menu” to resolve.
Error Lamp Expired	UV-C lamp has not been replaced within the recommended time frame. The system cannot treat any more water until a new lamp has been installed and the Lamp timer has been reset. See 5.1.1.5 on how to resolve this issue. If this error arises after the lamp has been changed this indicates that the timer was not reset. Follow the procedure “New/Reset Lamp” under “Settings Menu” to resolve.
Error CD Power Fail	The system has detected that the Corona Discharge unit is not operating within its power specification. Water treatment is not possible until this situation is resolved
Error Water Unavailable	This error indicates that the water level in the tank has fallen below 60 liters. This mechanism prevents air-locks from affecting the outlet pump. The machine will continue to fill and store water. Water Outlet Pump remains disabled until the error is cleared.

Annex VIII SPARE PARTS

P/N	Denomination	Note	Consumable
185390200	HYDROINF.DRYER	RESI & AGRI (Slave)	
185390210	HYDROINF.OZONE GENERATOR		
185390220	HYDROINF.DRYER	AGRI (Master)	
185390230	HYDROINF.AIR COMPRESSOR		
185390240	HYDROINF. ORP PROBE (REDOX)		(*)
185390250	HYDROINF.OZONE DIFFUSER		
185390260	HYDROINF.INLET MESH FILTER	Cartridge (Metal net)	
185390270	HYDROINF.LEVEL/TEMP SENSOR		
185390280	HYDROINF.UV REACTOR LAMP		(*)
185390290	HYDROINF.UV LAMP SLEEVE		
185390300	HYDROINF.ON/OFF VALVE		
185390310	HYDROINF.OUTLET FILTER	Cartridge (MnO ₂)	(*)
185390320	HYDROINF.INLET SOLENOID VALVE		
185390330	HYDROINF.INLET FILTER	Cartridge (PA wounded wire)	(*)
185390340	HYDROINF.SLEEVE SEAL BACK.RING		
185390350	HYDROINF.OZONE HOSE		
185390360	HYDROINF.SLEEVE LOCK NUT 11/4		
185390370	HYDROINF.CONTROL BOX		
185390380	HYDROINF.FILTER WRENCH		
185390390	HYDROINF.INLET MESH FILTER	Bowl	
185390400	HYDROINF.OUTLET FILTER	Bowl	
185390410	HYDROINF.INLET FILTER	Bowl	
185390420	HYDROINF.CATALYTIC FILTER	Container & Cartridge (MnO ₂ + CuO)	
185390430	HYDROINF.REACTOR BODY		
185390440	HYDROINF.FRONT COVER		
104600650YF4708	OUTLET PUMP	3HM04P05M5HVBEZ	
109120176	PUMP CONTROLLER	GENYO 8A/F15 SX	

LOGBOOK

| Date of installation | _____ | | Date of start-up | _____ |

Every 12 months or when needed whichever is shorter.

Component (*)	Date	Date	Date	Date	Date
Orp probe					
UV reactor lamp					
Inlet filter cartridge					
Outlet filter cartridge					

After 5 years or when needed whichever is shorter.

Component	Date	Date	Date
Inlet filter housing			
Outlet filter housing			
Inlet mesh filter cartridge			
Inlet mesh filter housing			
Catalytic Filter			

Other

Component	Date	Date	Date

Annex IX
Original EU Declaration of Conformity

This declaration relates exclusively to the product described below In the state in which it was placed on the market, and excludes components which are added and/or operations carried out subsequently by any third parties.

We, the manufacturer:

Ozone Industries Ireland Ltd t/a h2ozone™
Block 2, Newtown Bussh Park,
Newtownmountkennedy, Co. Wicklow,
A63 XV26, Ireland

Declare under our sole responsibility that the product described below:

HYDROINFINITY RESI-5/A and HYDROINFINITY AGRI-5/A

Is in compliance with the following EU Directives:

The Machinery Directive 2006/42/EC

The Electromagnetic Compatibility Directive 2014/30/EU

The Restriction of hazardous Substances Directive (RoHS) (as amended) 2011/65/EU

Low Voltage Directive 2014/35/EC

The RE Directive 2014/53/EU

And complies with the provisions of the following standards:

EN 60335-1:2012	Household and similar electrical appliances — Safety Part 1: General Requirements
EN 60335-2-109	Household and similar electrical appliances — Safety Part 2- 109: Particular requirements for UV radiation watertreatment appliances
EN 61000-6-31: 2007 + A1:2011	General Standards — Emission Standards for Residential, Commercial and Light Industrial
EN 61000-6-2:2005	Generic Standards-Immunity for Industrial Environments Equipment Classification: B for Emissions and A for Immunity
EN 55022	Information technology equipment — radio disturbance characteristics
4ASTM 04169-16, Level 1 Cycle 6	Assurance Standard Practice for Performance Testing of Shipping Containers and Systems.

Paul O'Grady of Ozone Industries Ireland Ltd, Block 2, Newtown Business and Enterprise Park, Newtownmountkennedy, Co. Wicklow, Ireland is authorised to compile the technical files.

Completed by: Ozone Industries Ireland Ltd, t/a h2ozone™
Block 2, Newtown Business Park,
Newtownmoixitkennedy, Co. Wicklow,
A63 XV26, Ireland

Name of signatory: Paul O'Grady

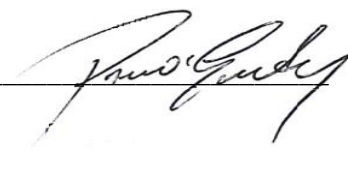
Chairperson 

Ozone Industries Ireland Ltd
Block 2, Newtown Business & Enterprise Park
Newtownmountkennedy
Co. Wicklow
A 63 XV26
Ireland

xylem
Let's Solve Water

Xylem is a trademark of Xylem Inc. and is used under license.
© 2018