

**Submersible motor pumps for domestic drainage- and waste water.**  
**Discharge G3 / DN 80.**  
**Vortex impellers, free passage 50-65 mm.**

**PolyPump Ltd**

Providing your pumping solutions  
 sales@polypump.co.uk  
 01296 488 294

## TP53 V

### Application

Submersible motor pumps in the TP53 series are used for conveying domestic drainage- and waste water as well as sludge. With their large free passage of 50-65 mm, they are particularly well suited for use with media containing coarse solids and fibers. Ideal for economical disposal in municipal, private, trade and industry applications.

**DIN EN 12050-2:** Design tested and monitored.

**Installation:** Stationary or mobile. Version with float switch for use as automatic water level controlled drainage pump.

**Pumped medium:** Clean water and waste water with solid and fibrous content.

Max. temperature of pumped medium: 40°C, for non-ex pumps brief periods up to 60°C.

**Operating mode:** Continuous operation (S1).

### Conveying capacities

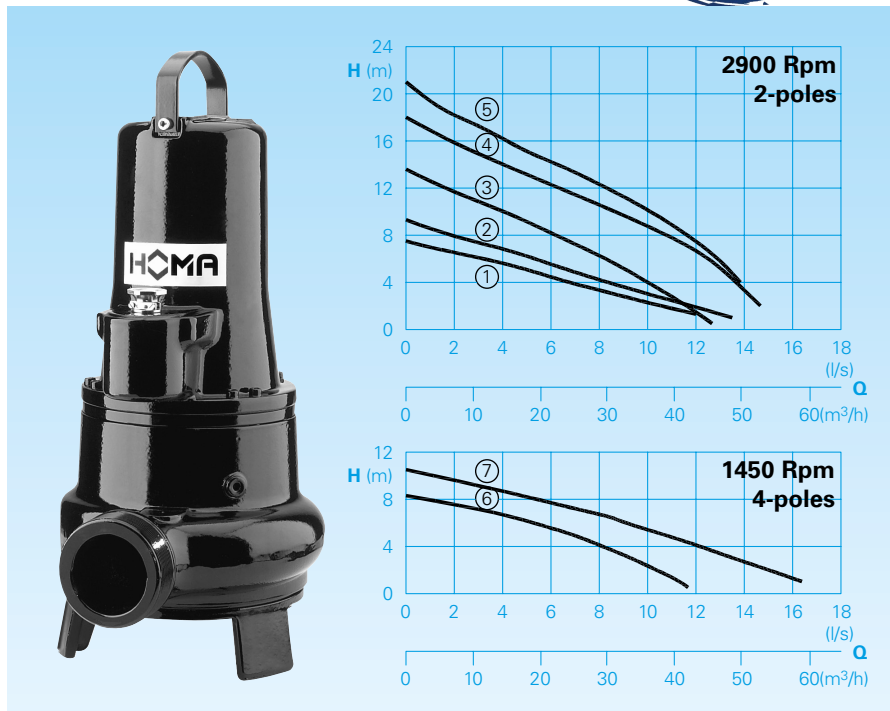

### Design

Fully submersible pump, consisting of:

**Pump:** Single-stage with horizontal discharge G3.

**Impeller:** Vortex impeller for media containing gas or air, with coarse or long stringy components that are prone to clogging. Free passage 50-65 mm.

**Motor:** Fully submersible motor, sealed against pressurized water. Insulation class H. Protection rating IP 68. Thermal sensor for temperature monitoring in the winding. Type of start: TP53V13-40: direct-on-line

TP53V50: direct- or star-delta-start  
 Connecting cable:

Model W: H07RN8-F 4G1,5

Model D and Ex: H07RN8-F 6G1,5

TP53V50(Ex): H07RN8-F 10G1,5

**Shaft/bearing:** Strongly dimensioned chrome steel shaft, lifetime-lubricated roller bearings.

**Seal:** Combination of 2 mechanical seals (silicon carbide/silicon carbide) inside the oil chamber that is independent of the direction of rotation.

Models up to 1,6 kW/2-poles combinations of mechanical seal and radial seal. Oil control possible from the outside.

**Explosion protection:** All pump models are also available in EX version according to II 2 G Ex c d II BT4(T3).

### Technical data

Curve No.	Pump type	Motor input P <sub>1</sub> (kW)	P <sub>2</sub> (kW)	Capacitor* (µF)	Rotational speed (rpm)	Nominal current (A)	Free passage (mm)	Weight (kg)
①	TP53V 17/2 W (A) (Ex)	1,6	1,2	30	2900	7,6	65	27,0**
②	TP53V 17/2 D (A) (Ex)	1,6	1,2		2900	2,9	65	27,0**
③	TP53V 26/2 D (A) (Ex)	2,6	2,1		2900	4,5	50	40,0
④	TP53V 40/2 D (A) (Ex)	4,0	3,4		2900	6,6	50	45,0
⑤	TP53V 50/2 D (Ex)	5,2	4,4		2840	8,7	50	56,0
⑥	TP53V 13/4 D (A) (Ex)	1,3	1,0		1450	2,6	50	40,0
⑦	TP53V 23/4 D (A) (Ex)	2,3	1,8		1450	5,0	62	45,0

**Model W:** 230V/1Ph 50Hz

**Model D:** 400V/3Ph 50Hz

**Model A:** with automatic

HOMA-Nivomatik float switch

\* **Capacitor:** for the operation it is necessary to install a capacitor into the switchgear.

**Model Ex:** explosion-proof

\*\* **Weight Ex Model:** + 5 kg

### Materials

Pump housing, impeller, motor housing	Cast iron EN-GJL-250
Motor shaft, screws	Stainless steel
Mechanical seals	Silicon carbide
Elastomers	NBR

### Scope of supply

Pump with base stand, without auto coupling (see accessories). With 10 m of loose cable end, switchgear (see accessories)

**Model A:** With automatic float switch and switchgear WA10/19; DA10/32; DA10/12 with motor protection, manual-auto-switch. Built in operating capacitor (just 1 Ph-models), mains plug. Ex-Model with intrinsically safe control circuit relay.

**Dimensions and installation example** (all dimensions in mm)

**Floorstanding installation with base stand**

TP53V17/2W+D(Ex)

TP53V23/4D(Ex)

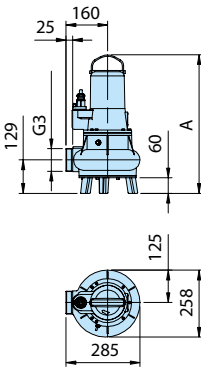
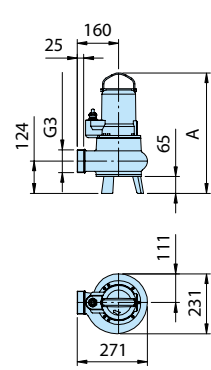

TP53V40/2D(Ex)  
TP53V26/2D(Ex)  
TP53V13/4D(Ex)

TP53V50/2DT(Ex)

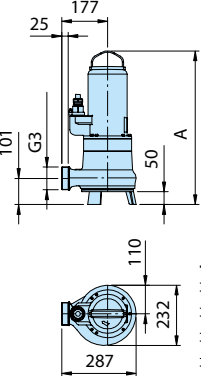
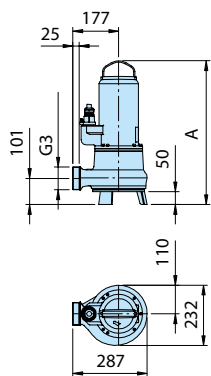

**Shaft installation with automatic coupling system**

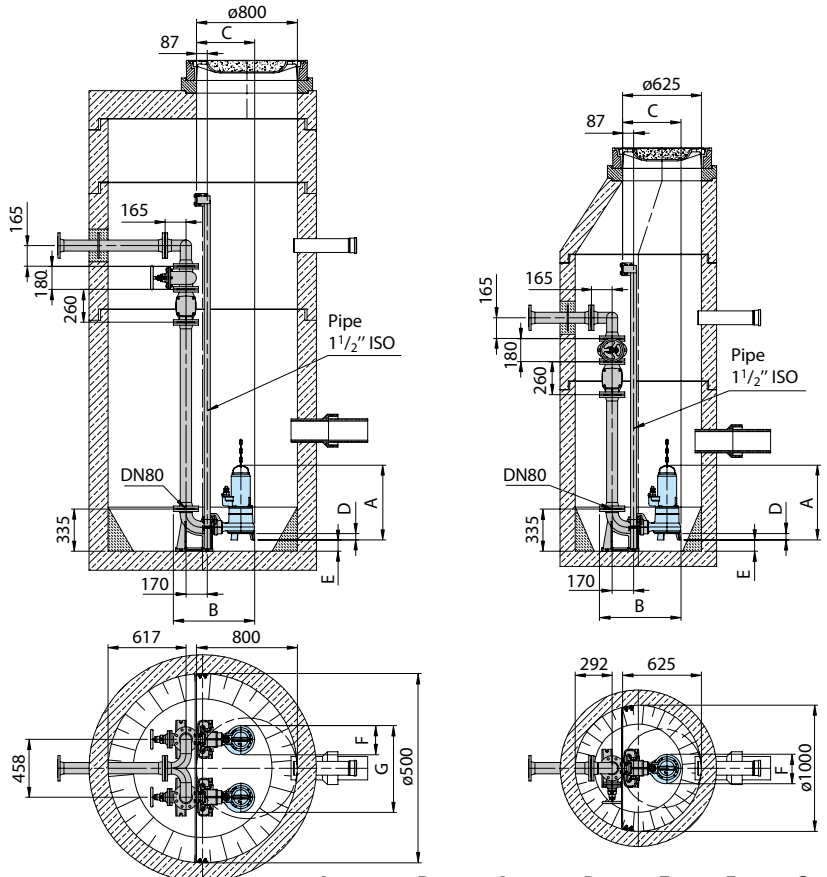

Type	A	B	C	D	E	F	G
TP53V50/2DT(Ex)	593	645	462	50	89	232	690
TP53V40/2D(Ex)	555	645	462	50	89	232	690
TP53V13/4D(Ex), TP53V26/2D(Ex)	518	645	462	50	89	232	690
TP53V17/2W + D(Ex)	465 (472)	629	446	65	66	231	689
TP53V23/4D(Ex)	572	648	465	60	61	258	716

**Accessories**

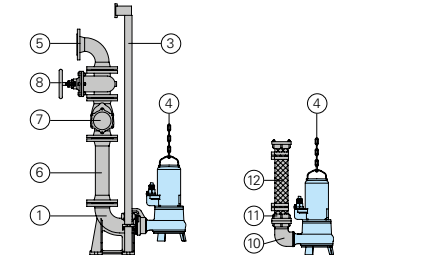

Description	Size	Part no.
① Automatic coupling system GG, with coupling base elbow DN 80, coupling mating flange and slide rail bracket BSP1½"		
- Type KK80/R3"	R3" F	8604035
- Type KK80/80	DN 80	8604025
○ Coupling system completely or partly in stainless steel	all	on request
○ Screw-kits for fastening coupling systems		on request
○ Threaded flange	DN 80/R3"F	2215080

Description	Size	Part no.	Description	Size	Part no.
③ Guide rails for coupling kits (steel galvanized and stainless steel A2/A4)		on request	⑧ Flanged gate valve with flanges	DN 80 DN 100	2216080 2216100
④ Pump chain sets, tested. With shackle, single or dual row, different lengths and load bearing capacities		on request	⑩ 90° Connection bend 90° Pipe bend with 2 flanges Threaded flange	R3" F/M DN 80 DN 80/R3" F	2111805 2153302 2215080
⑤ 90° pipe bend with 2 flanges	DN 80 DN 100	2153302 2153303	⑪ STORZ-fixed coupling STORZ-hose-coupling	B-G3" F B-75 mm Ø	2010602 2013502
Connection piece for merging the pressure pipe in double pump stations	3x DN 80 DN 80/80/100 3x DN 100	2160006 2160008 2160010	⑫ Plastic spiral-hose, 75 mm Ø, with 2-B-quick-couplings	2 m long 3 m long 5 m long	2161042 2161043 2161045
3 flanges, discharge horizontal (vertical discharge on request)			○ Plastic spiral hose, 90 mm Ø, with 2 flange connectors, DN 80	2 m long 3 m long 5 m long	2161032 2161033 2161035
⑥ Pressure pipe with 2 flanges (FF-piece)			Plastic spiral-hose, per m	Ø 75 mm Ø 90 mm	2632075 2632090
1 m long, 1 set of screws and seal	DN 80 DN 100	2152081 2152201	Flange connector DN 80	90 mm Ø	2171014
Pressure pipe extension per m	DN 80 DN 100	2150080 2150100	Hose clamps	85/20 92/20	2308520 2309221
Flanged reducer (FFR-piece) with 2 flanges		on request			
⑦ Non-return valve with flanges	DN 80 DN 100	2212807 2212809	○ For pump controllers and switchgears for mobile and stationary applications, measuring systems and monitoring devices,		see HOMA accessories



We reserve the right to alter our specifications without notice!